

truck and bus spare parts for

Mercedes Benz

Achse / Axle

63 450 187 AIR SPRING BASE

Mercedes Benz
357 320 15 34



63 450 188 AIR SPRING BASE

Mercedes Benz
393 320 10 18



21 401 019 BALL BEARING

Mercedes Benz
004 981 43 05

MAN
06.32489.0051

FAG
32018



63 451 183 BALL BEARING

Mercedes Benz
003 981 32 05



Achse / Axle

63 451 179 BALL JOINT

Mercedes Benz
000 996 70 45



21 000 004 BALL JOINT REPAIR KIT

Mercedes Benz
000 350 06 13

Iveco
93192618



23 326 088 BALL JOINT REPAIR KIT

Mercedes Benz
343 586 00 32



23 330 011 BALL JOINT REPAIR KIT

Mercedes Benz
000 330 14 11



Achse / Axle

23 350 002 BALL JOINT REPAIR KIT

Mercedes Benz
000 330 20 11

MAN
85.43220.6002



23 350 055 BALL JOINT REPAIR KIT

Mercedes Benz
000 350 08 05



23 350 107 BALL JOINT REPAIR KIT

Mercedes Benz 000 330 06 11	Scania 638862
MAN 81.43220.6107 81.95302.0059	



23 350 109 BALL JOINT REPAIR KIT

Mercedes Benz
000 350 05 06

MAN
81.43220.6073



Achse / Axle

23 350 116 BALL JOINT REPAIR KIT

Mercedes Benz
000 330 02 07

MAN
81.43230.6061



23 350 117 BALL JOINT REPAIR KIT

Mercedes Benz
000 350 04 13

MAN
81.43270.6040

Iveco
93192619



23 350 129 BALL JOINT REPAIR KIT

Mercedes Benz
000 350 01 13



23 350 130 BALL JOINT REPAIR KIT

Mercedes Benz
000 350 09 05



Achse / Axle

23 350 131 BALL JOINT REPAIR KIT

Mercedes Benz
000 350 25 05

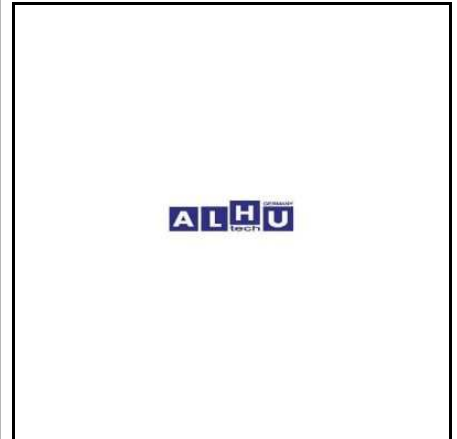

23 350 250 BALL JOINT REPAIR KIT

TGA

Mercedes Benz
000 350 15 13

MAN
81.43220.6250



23 350 433 BALL JOINT REPAIR KIT

Mercedes Benz
000 350 02 13
000 586 14 33

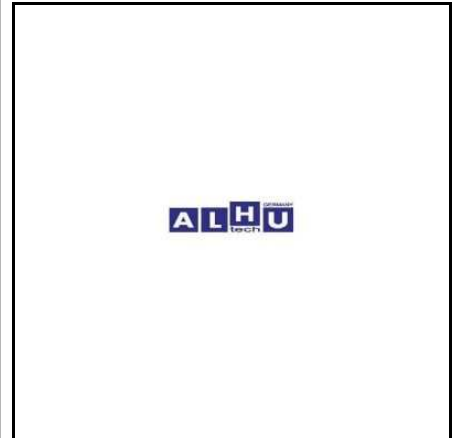

23 350 505 BALL JOINT REPAIR KIT

Mercedes Benz
000 350 24 05



Achse / Axle

23 350 605 BALL JOINT REPAIR KIT

Mercedes Benz
000 350 22 05

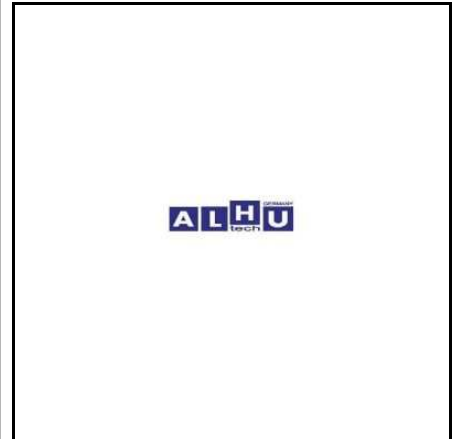

23 350 705 BALL JOINT REPAIR KIT

Mercedes Benz
000 350 21 05



23 350 906 BALL JOINT REPAIR KIT

Mercedes Benz
000 350 32 05

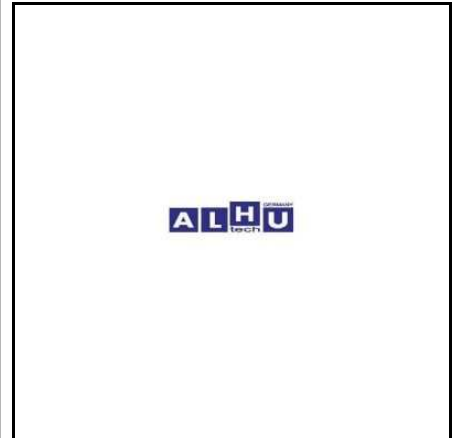

23 350 909 BALL JOINT REPAIR KIT

Mercedes Benz
000 350 31 05

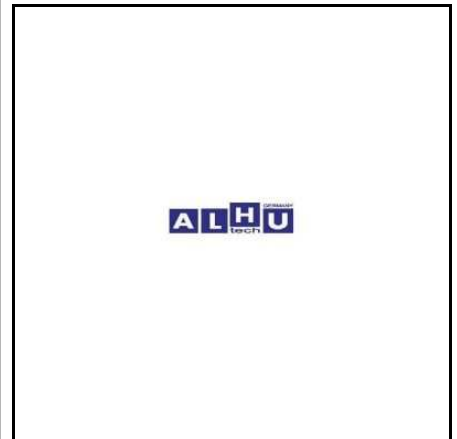

Achse / Axle

23 351 305 BALL JOINT REPAIR KIT

Mercedes Benz
000 350 20 05
000 350 47 05



23 351 405 BALL JOINT REPAIR KIT

Mercedes Benz
000 350 36 05



23 351 605 BALL JOINT REPAIR KIT

Mercedes Benz
000 350 27 05



23 351 705 BALL JOINT REPAIR KIT

Mercedes Benz
000 350 37 05



Achse / Axle

23 351 805 BALL JOINT REPAIR KIT

Mercedes Benz
000 350 19 05



23 351 905 BALL JOINT REPAIR KIT

Mercedes Benz
000 350 23 05
000 350 44 05

MAN
81.43270.6139



23 352 005 BALL JOINT REPAIR KIT

Mercedes Benz
000 350 48 05

MAN
81.43270.6126



23 352 105 BALL JOINT REPAIR KIT

Mercedes Benz
000 350 29 05



Achse / Axle

23 352 205 BALL JOINT REPAIR KIT

Mercedes Benz
000 350 45 05

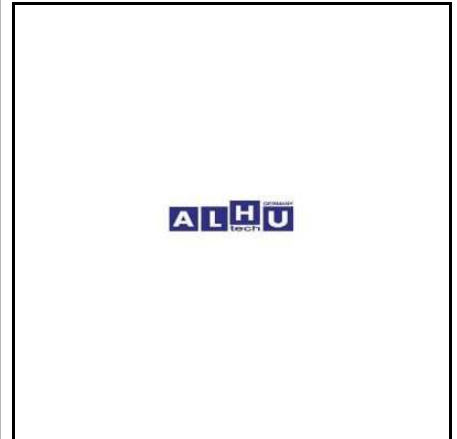

23 352 305 BALL JOINT REPAIR KIT

Mercedes Benz
000 350 49 05



63 450 052 BALL JOINT REPAIR KIT

Mercedes Benz
000 330 00 75



63 450 178 BALL JOINT REPAIR KIT

Mercedes Benz
000 350 02 05

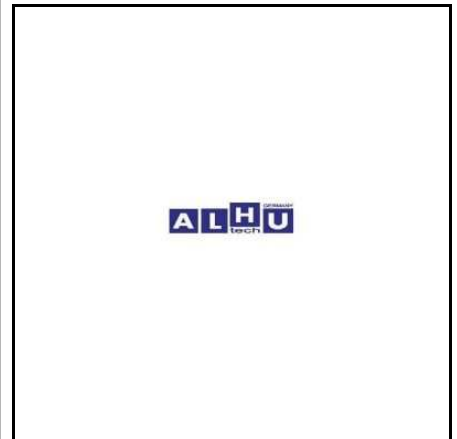

Achse / Axle

63 450 483 BALL JOINT REPAIR KIT

Mercedes Benz
000 350 04 05

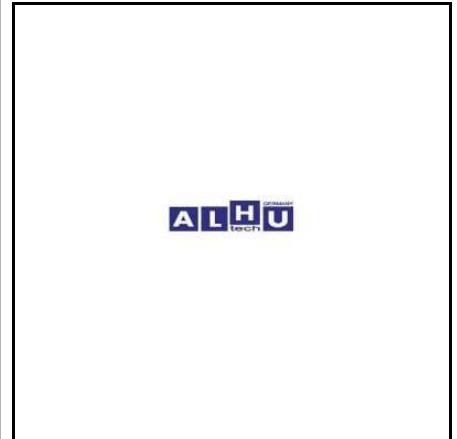

63 451 066 BALL JOINT REPAIR KIT

Mercedes Benz
629 330 00 07

Scania
1498132

MAN
81.43270.6091



63 451 166 BALL JOINT REPAIR KIT

Mercedes Benz
000 330 00 80



63 451 167 BALL JOINT REPAIR KIT

Mercedes Benz
000 350 05 13

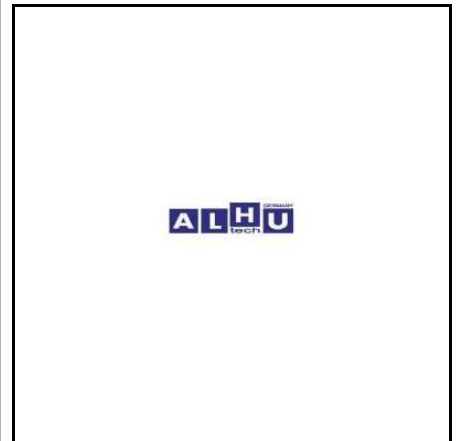

Achse / Axle

63 451 168 BALL JOINT REPAIR KIT

Mercedes Benz
000 350 10 05



63 451 169 BALL JOINT REPAIR KIT

Mercedes Benz
000 350 12 05



63 451 170 BALL JOINT REPAIR KIT

Mercedes Benz
000 350 13 05



63 451 171 BALL JOINT REPAIR KIT

Mercedes Benz
000 350 14 05

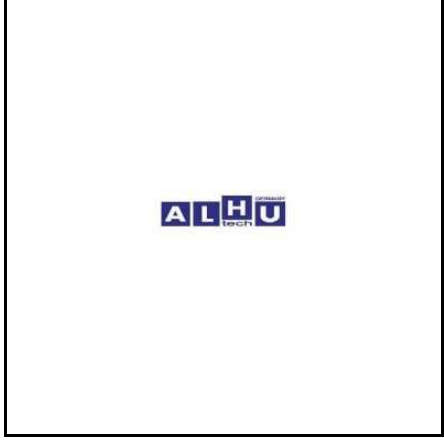

Achse / Axle

63 451 172 BALL JOINT REPAIR KIT

Mercedes Benz
000 350 15 05



63 451 173 BALL JOINT REPAIR KIT

Mercedes Benz
000 350 18 05



63 451 174 BALL JOINT REPAIR KIT

Mercedes Benz
000 350 26 05



63 451 175 BALL JOINT REPAIR KIT

Mercedes Benz
000 350 40 05



Achse / Axle

63 451 176 BALL JOINT REPAIR KIT

Mercedes Benz
000 350 41 05



63 451 177 BALL JOINT REPAIR KIT

Mercedes Benz
000 586 06 32



63 451 178 BALL JOINT REPAIR KIT

Mercedes Benz
000 586 10 35



63 451 232 BALL JOINT REPAIR KIT

Mercedes Benz
629 330 01 07



Achse / Axle

24 420 014	BEARING BUSH
	TGA TGS TGX
Mercedes Benz	000 981 60 31
MAN	06.36959.0014



21 323 140	BRACKET
Mercedes Benz	395 323 01 40



63 450 269	BRACKET
Mercedes Benz	357 320 15 43



63 450 270	BRACKET
Mercedes Benz	357 320 17 43

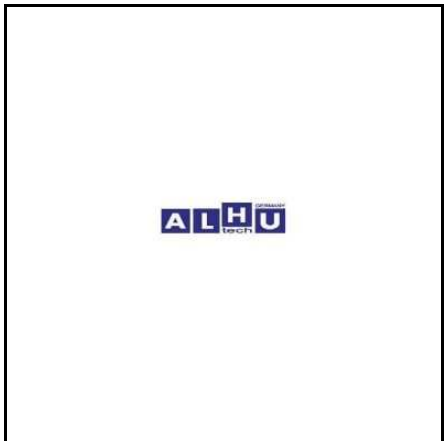

Achse / Axle

63 451 684 BRACKET



Mercedes Benz
620 295 02 40

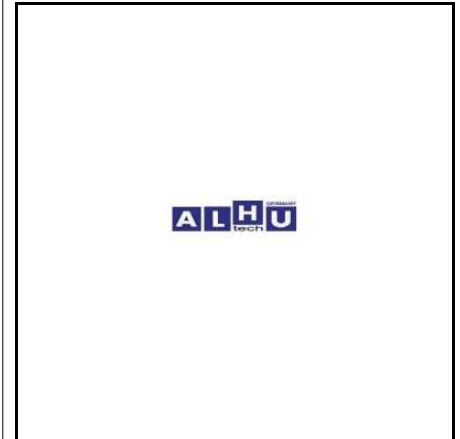

616708 BUSH

Mercedes Benz
653 353 00 50

MAN
81.93021.0218

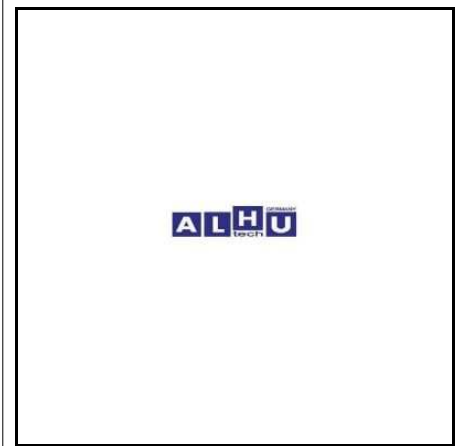

23 323 355 BUSHING

Mercedes Benz
941 326 00 50

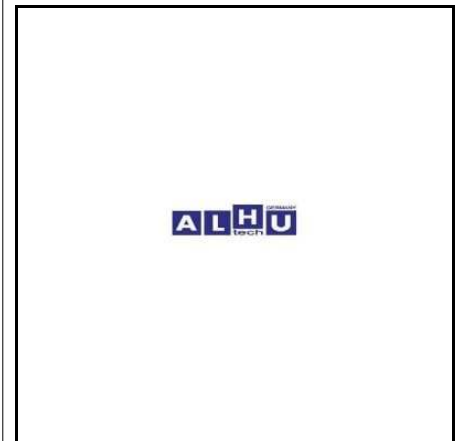

23 323 357 BUSHING

Mercedes Benz
942 326 00 50

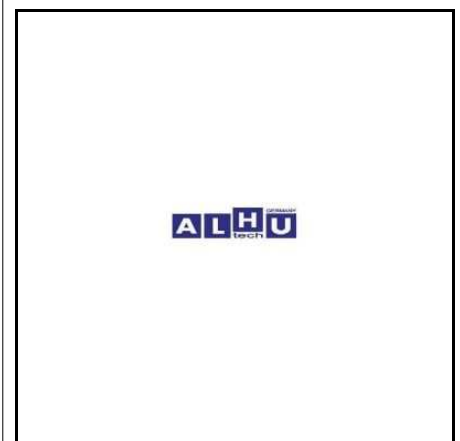

Achse / Axle

63 450 544 BUSHING

Mercedes Benz
942 310 00 49



21 990 501 CARDAN BOLT

Mercedes Benz
395 990 05 01

MAN
81.90001.0174



23 350 006 CONTROL ARM

Mercedes Benz
659 350 13 06



23 350 007 CONTROL ARM

Mercedes Benz
659 350 39 06

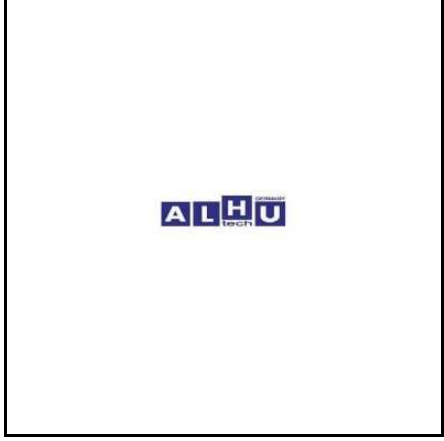

Achse / Axle

23 350 008 CONTROL ARM

Mercedes Benz
659 350 12 06
659 350 35 06



23 350 014 CONTROL ARM

Mercedes Benz
659 350 27 06



23 350 019 CONTROL ARM

Mercedes Benz
658 350 02 06



23 350 105 CONTROL ARM

ACTROS

Mercedes Benz
945 350 01 05
948 350 22 05
948 350 25 05

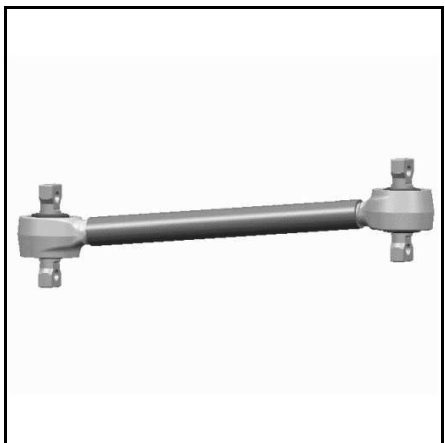

Achse / Axle

23 350 119 CONTROL ARM

Mercedes Benz
947 350 01 05
947 350 10 05



23 350 120 CONTROL ARM

Mercedes Benz
659 350 34 06



23 350 122 CONTROL ARM

Mercedes Benz
652 350 03 06
653 350 01 06



23 350 123 CONTROL ARM

Mercedes Benz
948 350 23 05



Achse / Axle

23 350 124 CONTROL ARM

Mercedes Benz
385 350 00 06



23 350 127 CONTROL ARM

Mercedes Benz
948 350 30 05



23 350 205 CONTROL ARM

Mercedes Benz
948 350 12 05



23 350 405 CONTROL ARM

Mercedes Benz
944 350 05 05
944 350 06 05
948 350 04 05



Achse / Axle

23 350 805 CONTROL ARM

Mercedes Benz
942 350 05 05
942 350 08 05

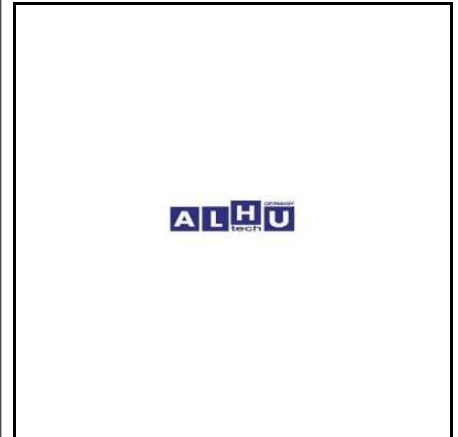

23 351 105 CONTROL ARM

Mercedes Benz
942 350 11 05

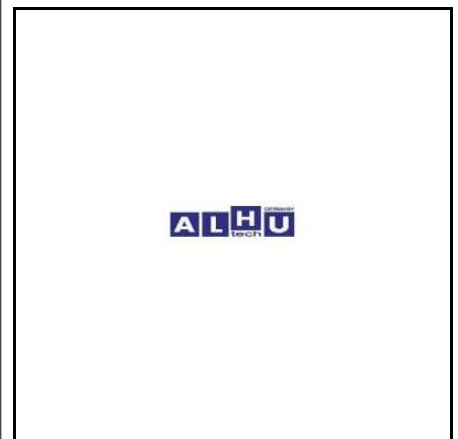

23 351 205 CONTROL ARM

Mercedes Benz
658 350 02 05

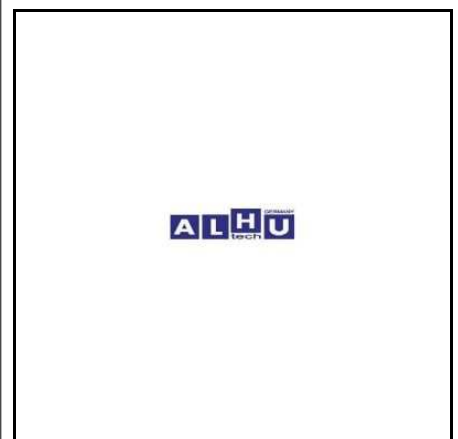

27 350 506 CONTROL ARM

Mercedes Benz
654 350 05 06

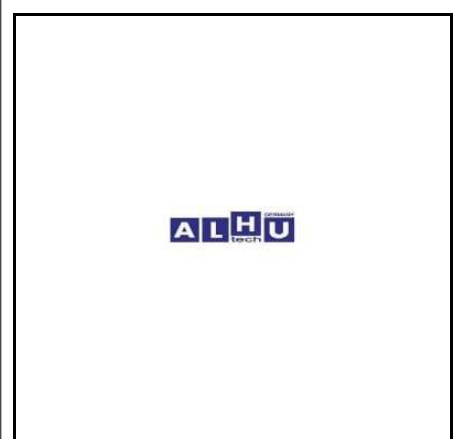

Achse / Axle

63 450 266 COVER

Mercedes Benz
655 330 00 56

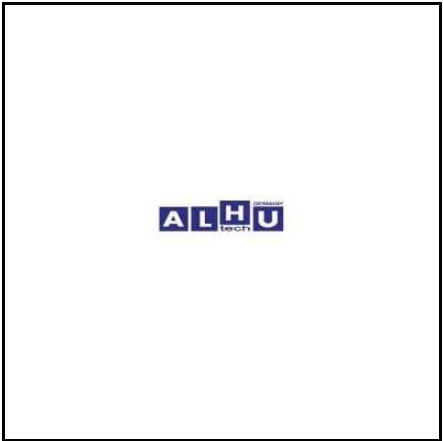

616702 DRIVE SHAFT

Mercedes Benz
355 353 09 35

MAN
81.35611.0017

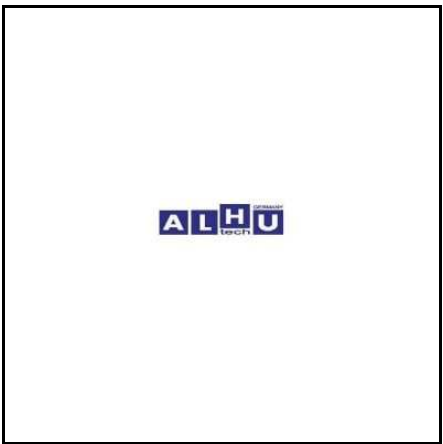

63 450 103 DRIVING FLANGE

Mercedes Benz
355 353 22 45

MAN
81.39115.0207

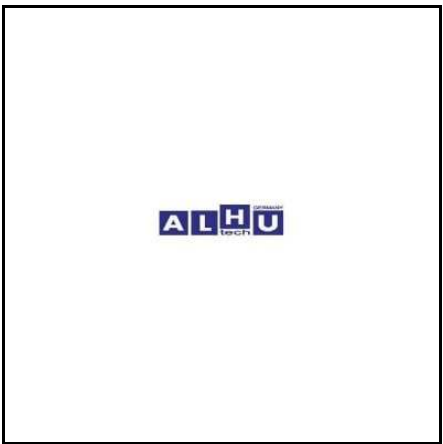

21 241 213 ENGINE MOUNTING

Mercedes Benz
941 241 82 13

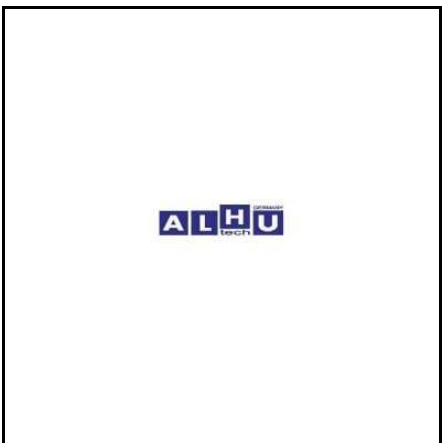

Achse / Axle

21 241 713 ENGINE MOUNTING

Mercedes Benz
941 241 87 13

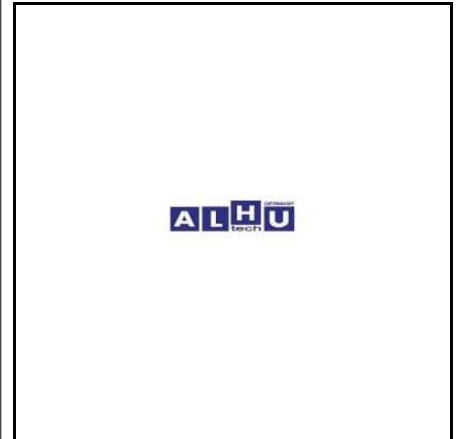

23 326 092 ENGINE MOUNTING

Mercedes Benz
617 240 02 17

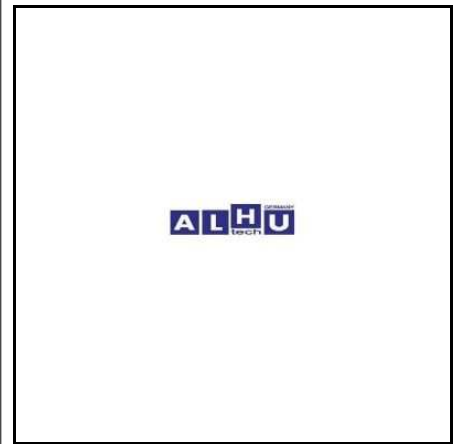

21 350 445 FLANGE

Mercedes Benz
346 350 04 45

MAN
81.39115.5030

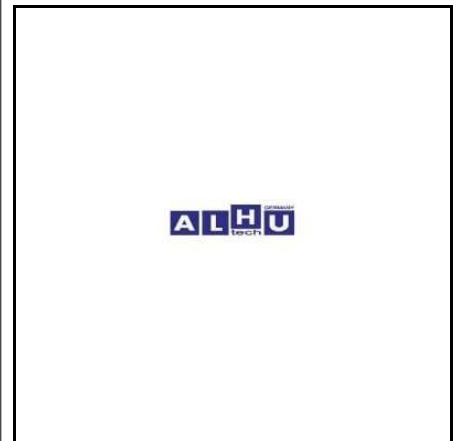

21 601 298 GASKET
APL axle

Mercedes Benz
650 356 01 80

MAN
81.96601.0298

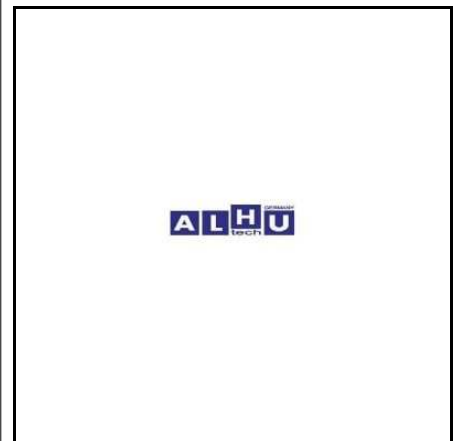

Achse / Axle

63 451 670 GEAR



Mercedes Benz
346 353 00 85

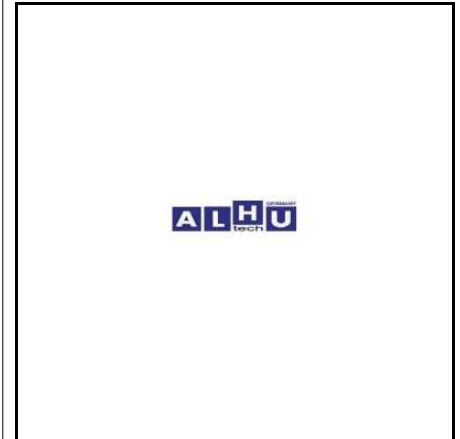

21 350 443 GROOVED NUT

Mercedes Benz
346 350 04 43

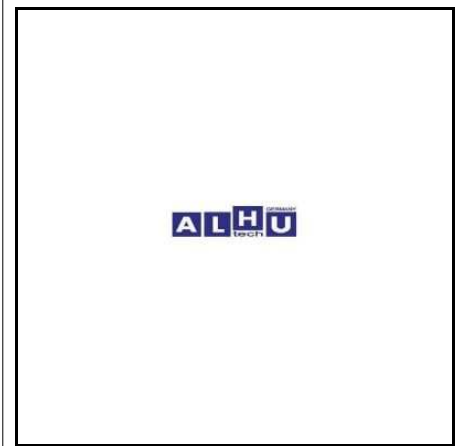

21 356 226 GROOVED NUT

Mercedes Benz
674 356 02 26

MAN
06.12114.0122

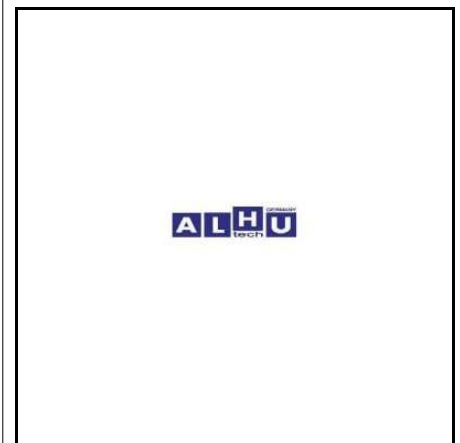

63 451 686 GROOVED NUT



Mercedes Benz
652 353 00 25

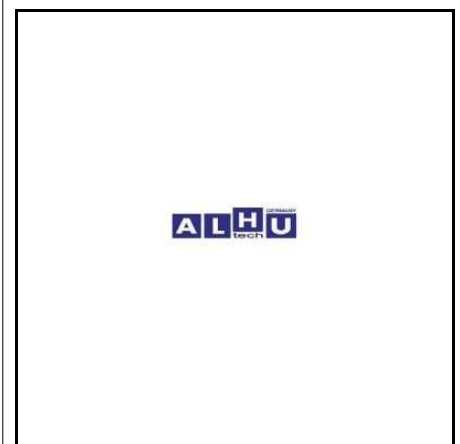

Achse / Axle

63 451 682 HELPER SPRING BRACKET



Mercedes Benz
684 325 00 17



21 114 086 HUB CAP

Mercedes Benz
624 356 00 20

MAN
81.35114.0086



21 320 684 HUB CAP

Mercedes Benz
389 320 06 84



21 334 025 HUB CAP

Mercedes Benz
389 334 00 25

MAN
81.44312.0003



Achse / Axle

24 420 015 JOINT BEARING

Mercedes Benz
000 981 61 31



63 450 259 KING PIN

Mercedes Benz
942 332 00 06



616706 KING PIN BUSHING

Mercedes Benz
355 353 09 50

MAN
81.93020.0678



616707 KING PIN BUSHING

Mercedes Benz
355 353 10 50

MAN
81.93020.0679



Achse / Axle

23 326 089 KING PIN SET

Mercedes Benz
346 330 00 19



23 330 019 KING PIN SET

Mercedes Benz
655 330 00 19



63 450 051 KING PIN SET

Mercedes Benz
360 330 06 19



63 451 191 KING PIN SET

Mercedes Benz
360 330 07 19

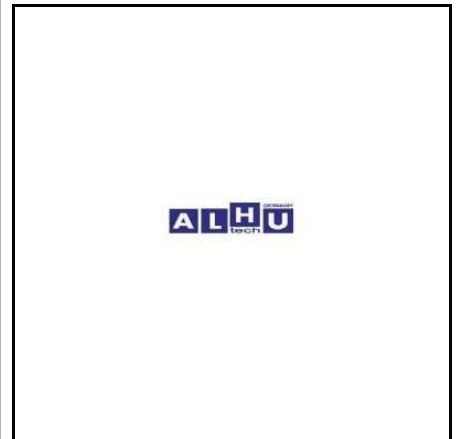

Achse / Axle

63 451 260 KING PIN SET

Mercedes Benz
670 330 02 19



63 451 288 KING PIN SET

Mercedes Benz
675 330 19 19



63 451 488 KING PIN SET

 **Mercedes Benz**
355 330 03 19



63 451 489 KING PIN SET

 **Mercedes Benz**
343 330 02 19



Achse / Axle

21 994 109 LOCK PLATE

Mercedes Benz
346 994 01 09

MAN
81.90801.0225



21 620 048 LOCK RING

Mercedes Benz
355 356 01 26

MAN
81.90620.0048



21 353 126 NUT

Mercedes Benz
346 353 01 26

MAN
81.90620.0047



21 990 060 NUT

Mercedes Benz
389 990 50 60



Achse / Axle

63 450 268 NUT

Mercedes Benz
000 990 32 60



63 450 102 OUTPUT SHAFT

Mercedes Benz
385 353 08 35

MAN
81.35604.0017



63 451 115 PIN

Mercedes Benz
307 421 00 74

MAN
81.50211.0030



23 356 015 PRESSURE RING

Mercedes Benz
946 356 00 15



Achse / Axle

23 356 215 PRESSURE RING

Mercedes Benz
355 356 12 15

MAN
81.35710.0045



23 356 415 PRESSURE RING

Mercedes Benz
346 356 14 15

MAN
81.35710.0044



63 450 063 PROPELLER SHAFT

Mercedes Benz
389 410 33 02



24 410 012 PROPELLER SHAFT BEARING

Mercedes Benz
654 411 00 12



Achse / Axle

24 410 022 PROPELLER SHAFT BEARING

Mercedes Benz
395 410 06 22
655 410 00 22



24 410 027 PROPELLER SHAFT BEARING

Mercedes Benz
973 411 00 12



24 410 522 PROPELLER SHAFT BEARING

Mercedes Benz
381 410 15 22



24 410 622 PROPELLER SHAFT BEARING

Mercedes Benz
973 410 00 22



Achse / Axle

24 410 722 PROPELLER SHAFT BEARING

Mercedes Benz
654 410 00 22



63 450 005 PROPELLER SHAFT BEARING

ACTROS

Mercedes Benz
000 410 10 10
656 411 00 12
656 411 02 12



23 326 087 PROPELLER SHAFT MOUNTING

Mercedes Benz
322 285 00 82



63 450 071 PROPELLER SHAFT REP. SET

Mercedes Benz
001 330 50 35



Achse / Axle

63 451 119 RADIATOR MOUNTING

MAN
81.96210.0243

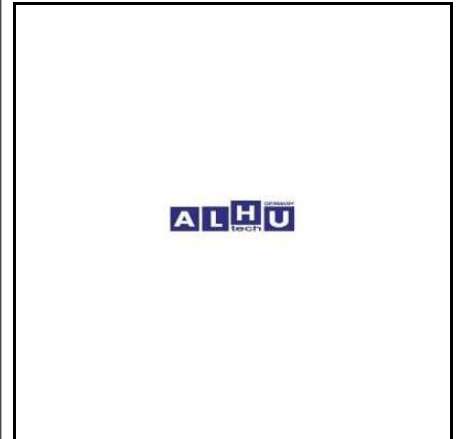

21 254 108 RELEASE LEVER

Mercedes Benz
620 254 01 08

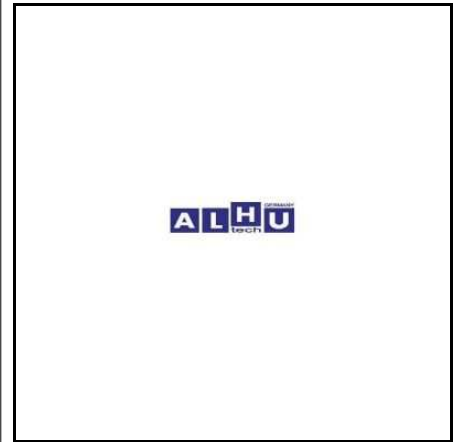

63 451 674 RELEASE RING



Mercedes Benz
000 252 12 45

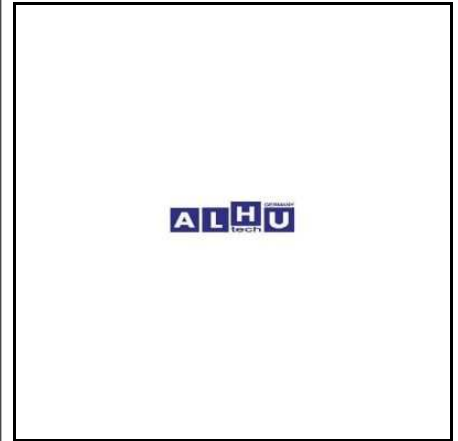

63 451 233 REPAIR KIT STUB AXLE

Mercedes Benz
631 330 14 49

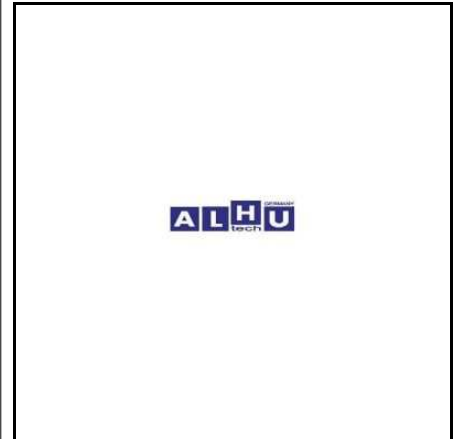

Achse / Axle

63 451 676 RETAINING WASHER



Mercedes Benz
346 353 01 24

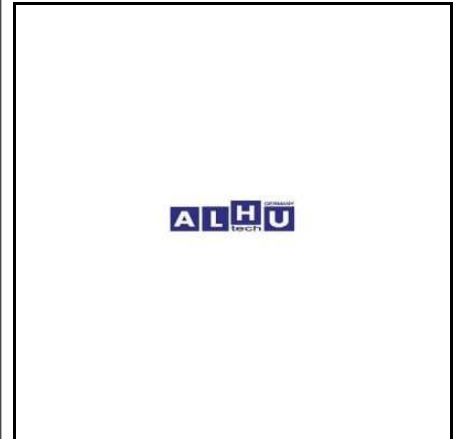

21 000 008 RUBBER MOUNTING

Mercedes Benz
941 241 57 13

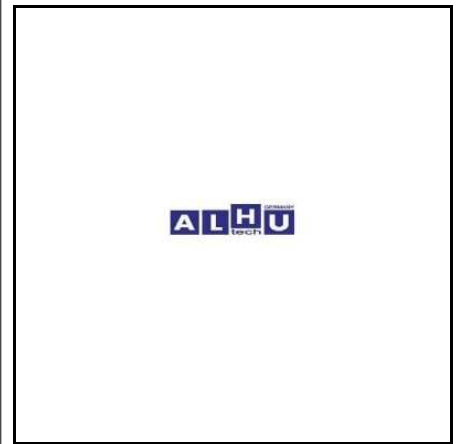

21 242 013 RUBBER MOUNTING

Mercedes Benz
668 242 00 13

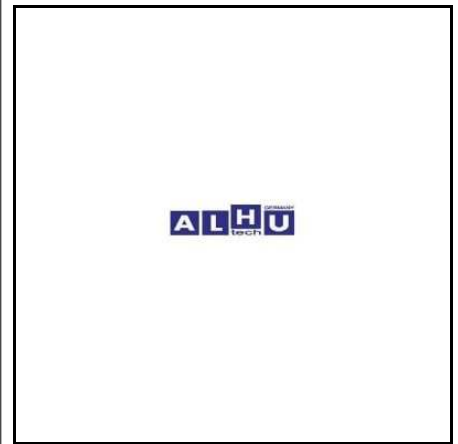

21 242 513 RUBBER MOUNTING

Mercedes Benz
668 242 05 13

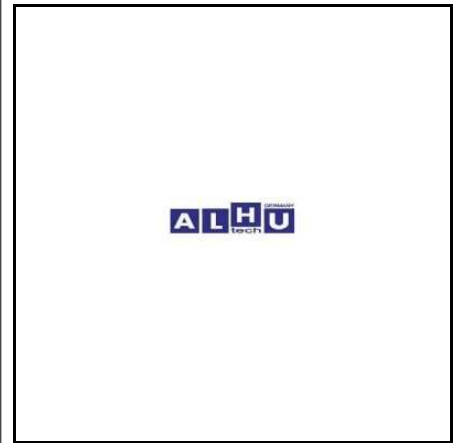

Achse / Axle

21 323 485 RUBBER MOUNTING

Mercedes Benz
000 323 34 85



21 325 050 RUBBER MOUNTING

Mercedes Benz
947 325 00 50



21 325 485 RUBBER MOUNTING

Mercedes Benz
000 325 04 85



23 240 117 RUBBER MOUNTING

Mercedes Benz
300 240 01 17



Achse / Axle

23 323 354 RUBBER MOUNTING

Mercedes Benz
941 241 76 13



23 326 091 RUBBER MOUNTING

ACTROS

Mercedes Benz
942 504 02 14



23 326 093 RUBBER MOUNTING

Mercedes Benz
000 241 05 13



23 326 094 RUBBER MOUNTING

Mercedes Benz
000 321 00 50
000 321 03 50



Achse / Axle

23 326 096 RUBBER MOUNTING

Mercedes Benz
001 987 53 40



63 450 474 RUBBER MOUNTING

Mercedes Benz
000 326 09 81



63 451 155 RUBBER MOUNTING

Mercedes Benz
000 241 36 13



63 451 157 RUBBER MOUNTING

Mercedes Benz
000 322 02 44



Achse / Axle

63 451 160 RUBBER MOUNTING

Mercedes Benz
000 323 58 85



63 451 161 RUBBER MOUNTING

Mercedes Benz
000 323 78 85



63 451 165 RUBBER MOUNTING

Mercedes Benz
000 326 51 81



63 451 180 RUBBER MOUNTING

Mercedes Benz
001 987 52 40



Achse / Axle

63 451 181 RUBBER MOUNTING

Mercedes Benz
001 987 71 40

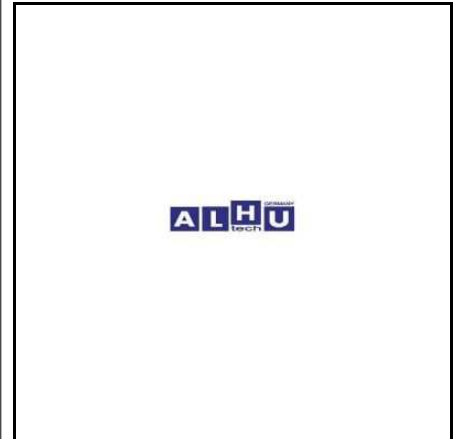

63 451 184 RUBBER MOUNTING

Mercedes Benz
347 504 00 12

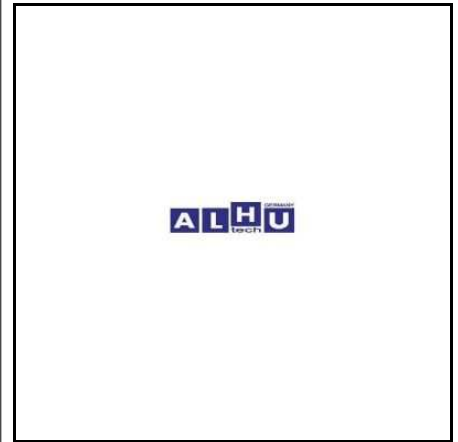

63 451 187 RUBBER MOUNTING

Mercedes Benz
357 240 04 18



63 451 239 RUBBER MOUNTING

Mercedes Benz
653 326 03 81

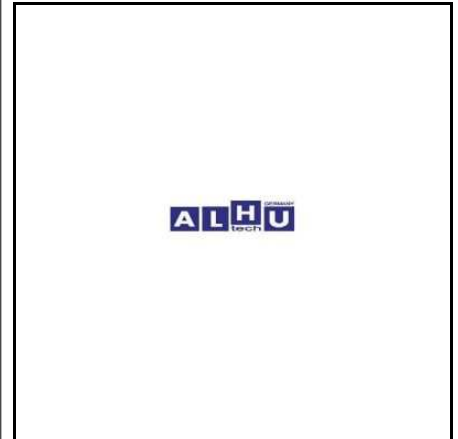

Achse / Axle

63 451 248 RUBBER MOUNTING

Mercedes Benz
667 317 00 12



63 451 249 RUBBER MOUNTING

Mercedes Benz
667 317 02 36



63 451 250 RUBBER MOUNTING

Mercedes Benz
667 320 00 44



63 451 251 RUBBER MOUNTING

Mercedes Benz
667 320 00 73

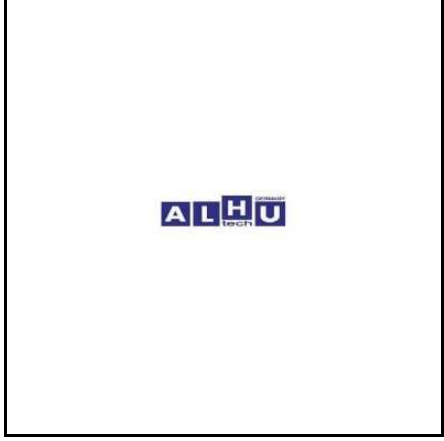

Achse / Axle

63 451 252 RUBBER MOUNTING

Mercedes Benz
667 320 00 77



63 451 253 RUBBER MOUNTING

Mercedes Benz
667 323 03 85



63 451 254 RUBBER MOUNTING

Mercedes Benz
667 323 04 85



63 451 255 RUBBER MOUNTING

Mercedes Benz
667 326 01 81



Achse / Axle

63 451 256 RUBBER MOUNTING

Mercedes Benz
667 326 14 40



63 451 257 RUBBER MOUNTING

Mercedes Benz
667 326 14 81



63 451 258 RUBBER MOUNTING

Mercedes Benz
670 320 03 44



63 451 259 RUBBER MOUNTING

Mercedes Benz
670 320 04 44



Achse / Axle

63 451 264 RUBBER MOUNTING

Mercedes Benz
673 323 03 85



63 451 266 RUBBER MOUNTING

Mercedes Benz
673 324 04 08



63 451 267 RUBBER MOUNTING

Mercedes Benz
673 325 01 44



63 451 268 RUBBER MOUNTING

Mercedes Benz
673 325 02 84



Achse / Axle

63 451 269 RUBBER MOUNTING

Mercedes Benz
673 326 06 81



63 451 271 RUBBER MOUNTING

Mercedes Benz
674 317 08 12



63 451 272 RUBBER MOUNTING

Mercedes Benz
674 325 02 44



63 451 273 RUBBER MOUNTING

Mercedes Benz
674 325 03 44



Achse / Axle

63 451 277 RUBBER MOUNTING

Mercedes Benz
675 323 04 85



63 451 278 RUBBER MOUNTING

Mercedes Benz
675 323 14 85



63 451 279 RUBBER MOUNTING

Mercedes Benz
675 323 18 85



63 451 280 RUBBER MOUNTING

Mercedes Benz
675 323 19 85



Achse / Axle

63 451 281 RUBBER MOUNTING

Mercedes Benz
675 323 23 85



63 451 282 RUBBER MOUNTING

Mercedes Benz
675 324 00 08



63 451 283 RUBBER MOUNTING

Mercedes Benz
675 325 01 44



63 451 284 RUBBER MOUNTING

Mercedes Benz
675 325 05 85



Achse / Axle

63 451 285 RUBBER MOUNTING

Mercedes Benz
675 326 05 81



63 451 286 RUBBER MOUNTING

Mercedes Benz
675 326 09 81



63 451 287 RUBBER MOUNTING

Mercedes Benz
675 326 12 81



63 451 289 RUBBER MOUNTING

Mercedes Benz
676 323 00 85



Achse / Axle

63 451 290 RUBBER MOUNTING

Mercedes Benz
901 241 25 13



63 451 291 RUBBER MOUNTING

Mercedes Benz
901 322 04 19



63 451 292 RUBBER MOUNTING

Mercedes Benz
901 322 21 19



63 451 293 RUBBER MOUNTING

Mercedes Benz
901 322 22 19



Achse / Axle

63 451 294 RUBBER MOUNTING

Mercedes Benz
901 322 26 19



63 451 295 RUBBER MOUNTING

Mercedes Benz
901 323 01 85



63 451 296 RUBBER MOUNTING

Mercedes Benz
901 323 02 85



63 451 297 RUBBER MOUNTING

Mercedes Benz
901 323 02 88



Achse / Axle

63 451 298 RUBBER MOUNTING

Mercedes Benz
901 325 01 44



63 451 299 RUBBER MOUNTING

Mercedes Benz
901 326 00 81



63 451 300 RUBBER MOUNTING

Mercedes Benz
901 333 02 14



63 451 301 RUBBER MOUNTING

Mercedes Benz
904 323 00 85



Achse / Axle

63 451 302 RUBBER MOUNTING

Mercedes Benz
904 326 08 81



63 451 303 RUBBER MOUNTING

Mercedes Benz
904 326 10 81



63 451 304 RUBBER MOUNTING

Mercedes Benz
906 323 16 85



63 451 307 RUBBER MOUNTING

Mercedes Benz
942 317 22 12



Achse / Axle

63 451 321 RUBBER MOUNTING

Mercedes Benz
970 317 01 12



63 451 322 RUBBER MOUNTING

Mercedes Benz
970 320 01 44



63 451 323 RUBBER MOUNTING

Mercedes Benz
970 320 03 44



63 451 324 RUBBER MOUNTING

Mercedes Benz
970 323 12 85



Achse / Axle

63 451 325 RUBBER MOUNTING

Mercedes Benz
970 323 14 85



63 451 326 RUBBER MOUNTING

Mercedes Benz
970 323 15 85



63 451 327 RUBBER MOUNTING

Mercedes Benz
970 323 20 85



63 451 328 RUBBER MOUNTING

Mercedes Benz
974 320 00 44



Achse / Axle

63 451 329 RUBBER MOUNTING

Mercedes Benz
974 323 03 85



63 451 330 RUBBER MOUNTING

Mercedes Benz
974 328 01 81



21 990 001 SCREW

Mercedes Benz
659 990 00 01



23 332 011 SEAL HOLDER

TGA TGS TGX

Mercedes Benz
346 423 00 58

MAN
81.50308.0011



Achse / Axle

63 451 152 SEAL HOLDER

Mercedes Benz
355 353 01 58

MAN
81.35412.0009

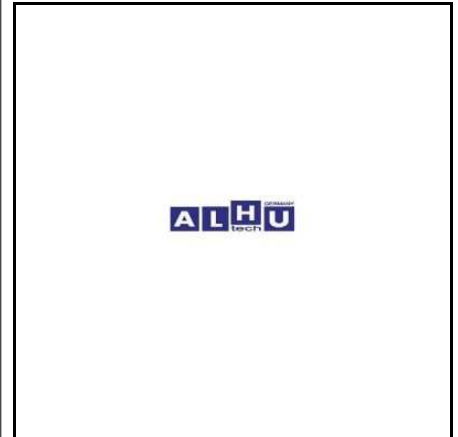

63 450 104 SELECTOR FORK

Mercedes Benz
355 353 02 34

MAN
81.35614.0001

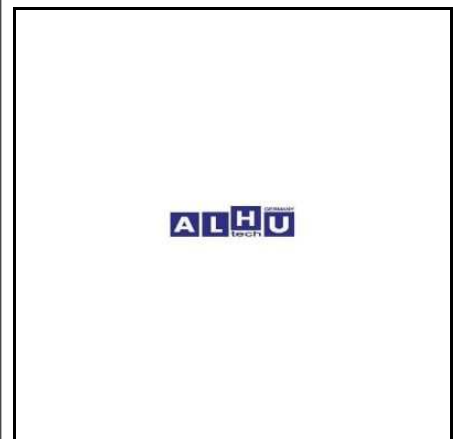

63 450 105 SHIFT CYLINDER

Mercedes Benz
346 353 06 55

MAN
81.35631.0006

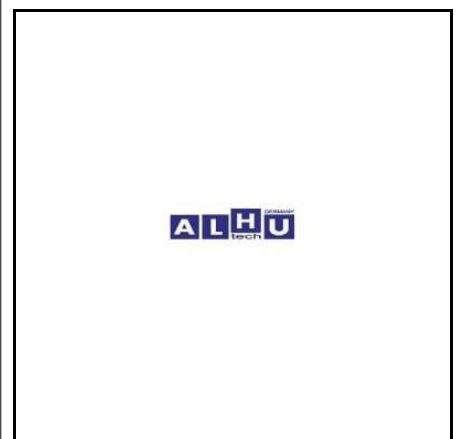

63 450 271 SHIM

Mercedes Benz
005 990 50 40

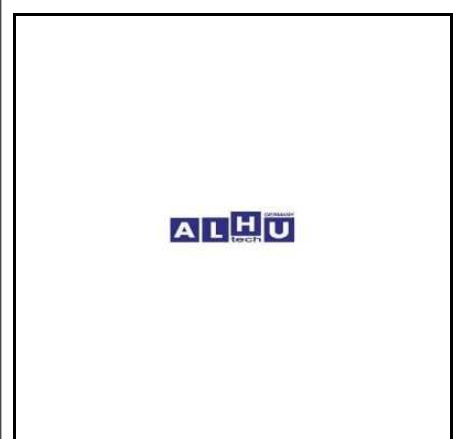

Achse / Axle

21 323 001 SHOCK ABSORBER

Mercedes Benz
002 323 15 00



21 323 002 SHOCK ABSORBER

Mercedes Benz
002 323 16 00



21 323 003 SHOCK ABSORBER

Mercedes Benz
387 326 00 00



21 323 004 SHOCK ABSORBER

Mercedes Benz
005 323 95 00



Achse / Axle

21 323 006 SHOCK ABSORBER

Mercedes Benz
006 323 09 00



21 323 007 SHOCK ABSORBER

Mercedes Benz
006 323 07 00



21 323 008 SHOCK ABSORBER

Mercedes Benz
356 326 07 00



63 450 024 SHOCK ABSORBER

Mercedes Benz
942 890 05 19



Achse / Axle

63 450 026 SHOCK ABSORBER

Mercedes Benz
942 890 53 19



63 450 027 SHOCK ABSORBER

Mercedes Benz
005 323 60 00



63 450 029 SHOCK ABSORBER

Mercedes Benz
005 326 11 00



63 450 031 SHOCK ABSORBER

Mercedes Benz
617 326 00 00



Achse / Axle

63 450 032 SHOCK ABSORBER

Mercedes Benz
006 326 01 00



63 450 041 SHOCK ABSORBER

Mercedes Benz
005 326 33 00



63 450 042 SHOCK ABSORBER

Mercedes Benz
942 890 47 19



63 450 065 SHOCK ABSORBER

Mercedes Benz
357 323 04 00

MAN
81.43701.6713



Achse / Axle

63 450 173 SHOCK ABSORBER

Mercedes Benz
003 326 44 00

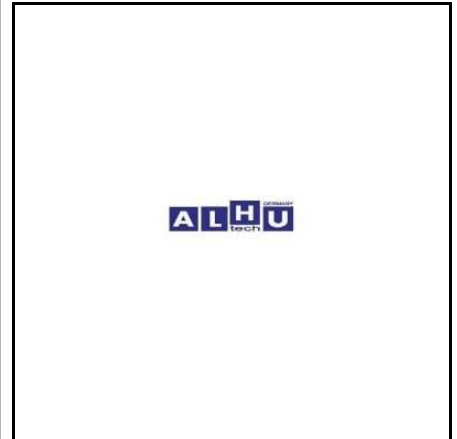

24 420 243 SPACER

Mercedes Benz
346 423 07 52

MAN
81.90713.0243



63 451 190 SPACER RING

Mercedes Benz
360 323 01 51

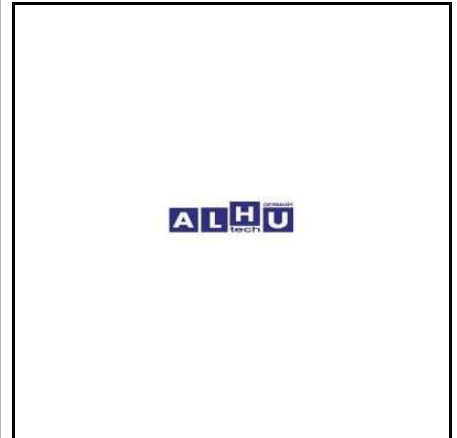

21 325 152 SPACER WASHER

Mercedes Benz
389 325 21 52

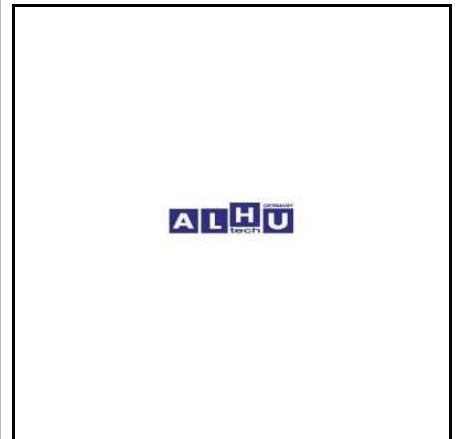

Achse / Axle

63 451 681 SPRING BRACKET



Mercedes Benz
387 325 00 01



63 451 261 SPRING BUSHING

Mercedes Benz
673 320 00 50



63 451 262 SPRING BUSHING

Mercedes Benz
673 320 01 50



63 451 263 SPRING BUSHING

Mercedes Benz
673 320 02 50



Achse / Axle

63 451 275 SPRING BUSHING

Mercedes Benz
675 320 00 50

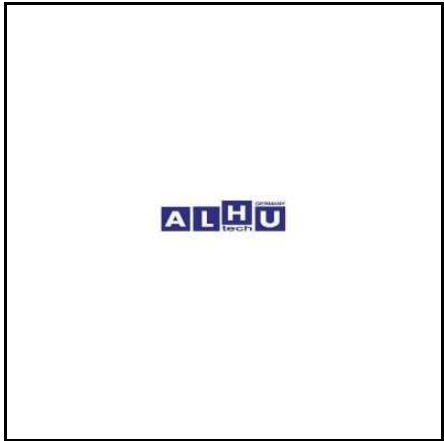

63 451 276 SPRING BUSHING

Mercedes Benz
675 320 01 50



23 325 596 SPRING CUSHION

Mercedes Benz
000 325 05 96



23 325 896 SPRING CUSHION

Mercedes Benz
000 325 08 96

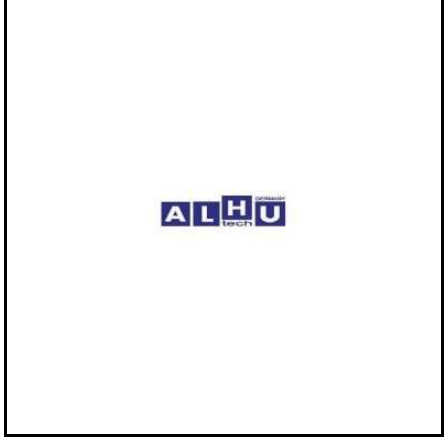

Achse / Axle

63 451 683 SPRING MOUNTING



Mercedes Benz
395 312 01 24

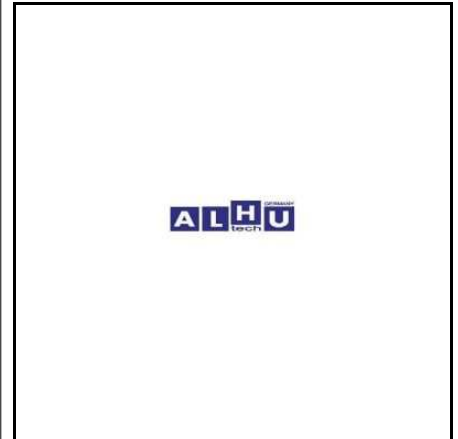

63 450 471 SPRING PIN KIT

Mercedes Benz
389 320 00 65

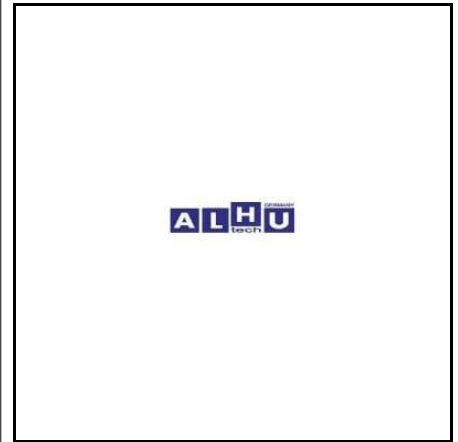

63 450 844 SPRING PIN KIT



Mercedes Benz
395 320 02 65

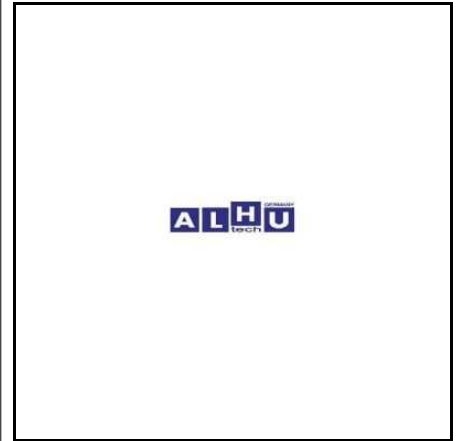

63 451 197 SPRING PIN KIT

Mercedes Benz
385 320 00 65

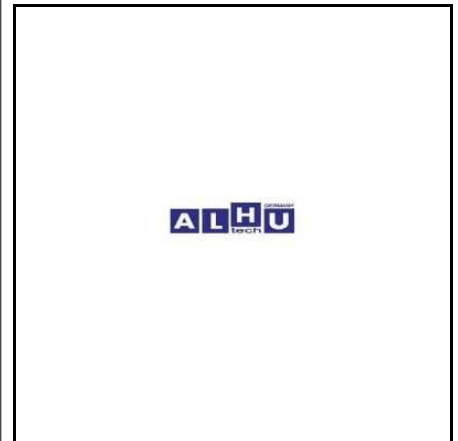

Achse / Axle

63 451 205 SPRING PIN KIT

Mercedes Benz
389 320 01 65



63 451 208 SPRING PIN KIT

Mercedes Benz
395 320 01 65



63 451 247 SPRING PIN KIT

Mercedes Benz
658 320 00 65



63 451 669 SPRING SADDLE



Mercedes Benz
624 325 01 12



Achse / Axle

23 325 219 SPRING SEAT

91 MM black

Mercedes Benz

624 325 02 19



23 325 319 SPRING SEAT

91 MM black

Mercedes Benz

624 325 03 19



23 325 419 SPRING SEAT

77 MM

Mercedes Benz

625 325 00 19



23 325 519 SPRING SEAT

77 MM

Mercedes Benz

625 325 01 19



Achse / Axle

23 325 619	SPRING SEAT
107 MM black	
Mercedes Benz	
625 325 02 19	



23 325 719	SPRING SEAT
107 MM black	
Mercedes Benz	
625 325 03 19	



21 320 063	SPRING SHACKLE
Mercedes Benz	
346 320 50 63	

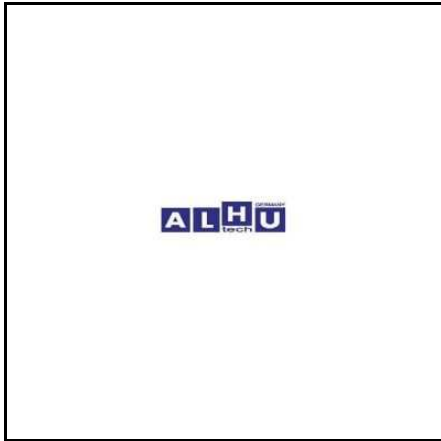

63 451 319	SPRING SHACKLE BUSHING
Mercedes Benz	
949 320 00 73	

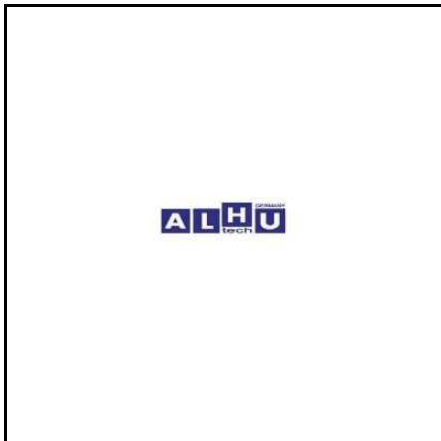

Achse / Axle

21 000 003 STABILIZER BUSHING

Mercedes Benz
000 326 06 50

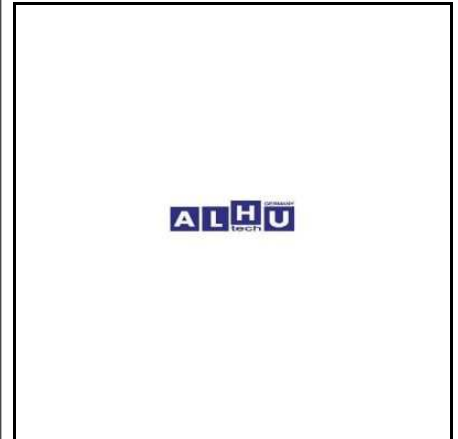

21 000 006 STABILIZER BUSHING

Mercedes Benz
387 323 02 85

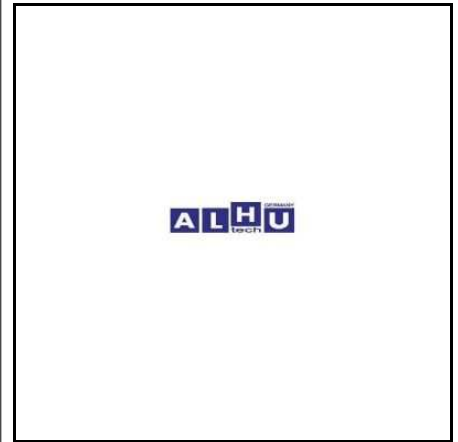

21 326 000 STABILIZER BUSHING

Mercedes Benz
000 326 17 81

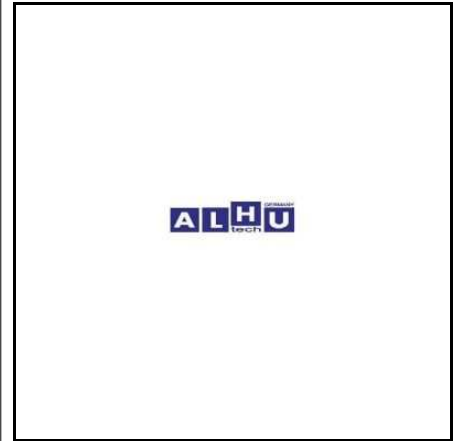

21 326 001 STABILIZER BUSHING

Mercedes Benz
000 326 08 81

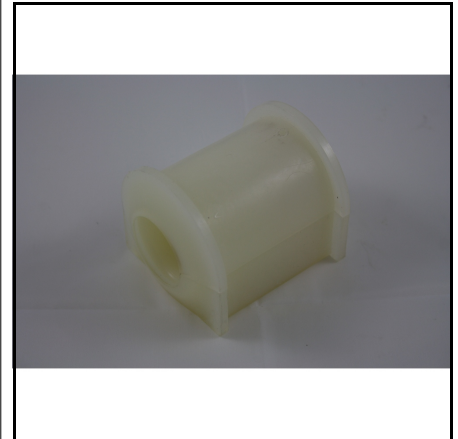

Achse / Axle

23 323 350 STABILIZER BUSHING

Mercedes Benz
941 323 03 50



23 323 353 STABILIZER BUSHING

Mercedes Benz
941 323 00 50



23 324 085 STABILIZER BUSHING

Mercedes Benz
675 323 13 85



23 324 185 STABILIZER BUSHING

Mercedes Benz
970 323 17 85



Achse / Axle

23 325 285 STABILIZER BUSHING

Mercedes Benz
000 325 02 85
000 325 13 85

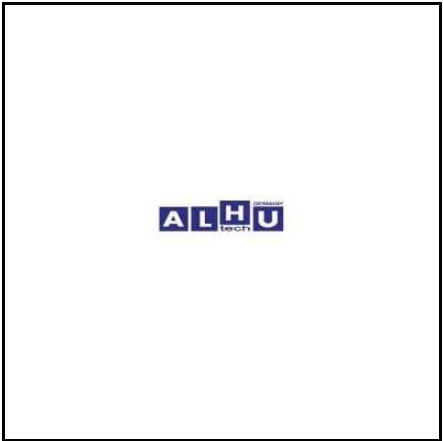

23 326 090 STABILIZER BUSHING

Mercedes Benz
387 326 02 81

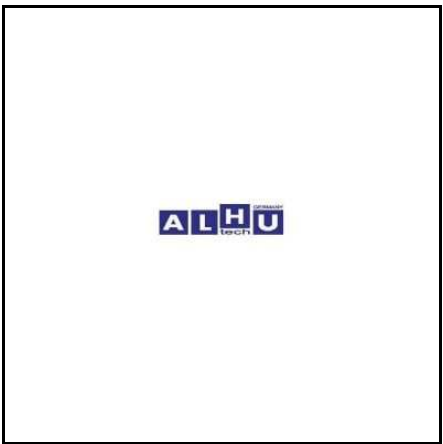

23 327 081 STABILIZER BUSHING

Mercedes Benz
000 326 23 81

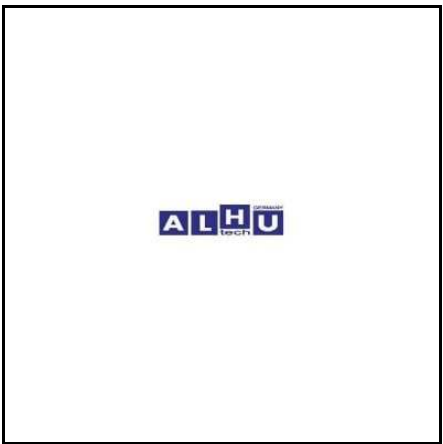

28 500 050 STABILIZER BUSHING

Mercedes Benz
942 500 00 50



Achse / Axle

63 450 421 STABILIZER BUSHING

Mercedes Benz
620 323 03 50

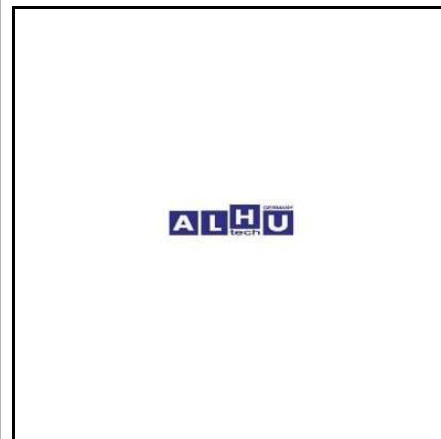

63 450 473 STABILIZER BUSHING

Mercedes Benz
000 326 02 50

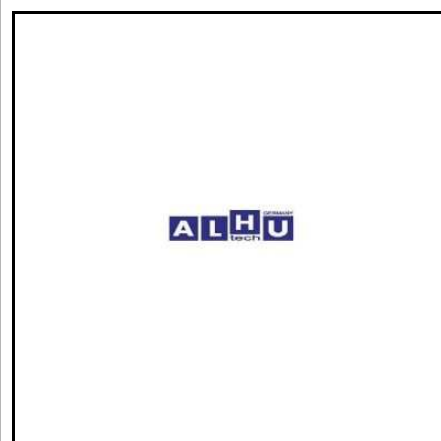

63 450 581 STABILIZER BUSHING

Mercedes Benz
000 323 37 85

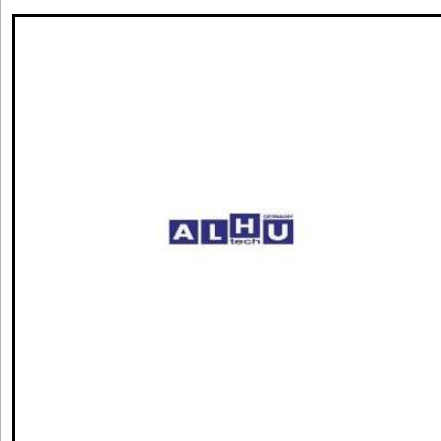

63 451 240 STABILIZER BUSHING

Mercedes Benz
653 326 04 81

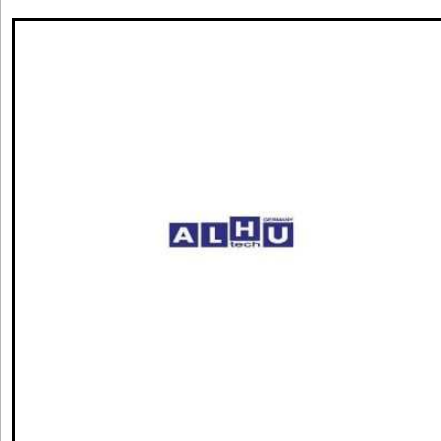

Achse / Axle

63 451 242 STABILIZER BUSHING

Mercedes Benz
655 326 04 81



21 000 007 STABILIZER KIT

Mercedes Benz
620 320 01 28



21 320 001 STABILIZER KIT

Mercedes Benz
393 320 02 28



23 320 428 STABILIZER KIT

Mercedes Benz
620 320 04 28



Achse / Axle

63 450 475 STABILIZER KIT

Mercedes Benz
621 320 04 28



63 450 476 STABILIZER KIT

Mercedes Benz
620 320 06 28



63 450 477 STABILIZER KIT

Mercedes Benz
624 320 00 28



63 450 478 STABILIZER KIT

Mercedes Benz
360 320 00 41



Achse / Axle

63 450 480 STABILIZER KIT

Mercedes Benz
387 320 01 28



63 450 566 STABILIZER KIT

Mercedes Benz
387 320 00 28



63 450 567 STABILIZER KIT

Mercedes Benz
620 320 00 28



63 450 582 STABILIZER KIT

Mercedes Benz
346 320 01 28



Achse / Axle

63 451 188 STABILIZER KIT

Mercedes Benz
360 320 03 41



63 451 192 STABILIZER KIT

Mercedes Benz
363 320 02 28



63 451 198 STABILIZER KIT

Mercedes Benz
387 320 03 28



63 451 199 STABILIZER KIT

Mercedes Benz
387 320 05 28



Achse / Axle

63 451 211 STABILIZER KIT

Mercedes Benz
617 320 01 28



63 451 212 STABILIZER KIT

Mercedes Benz
617 320 02 28



63 451 216 STABILIZER KIT

Mercedes Benz
620 320 01 11



63 451 224 STABILIZER KIT

Mercedes Benz
621 320 00 11



Achse / Axle

63 451 225 STABILIZER KIT

Mercedes Benz
621 320 01 28

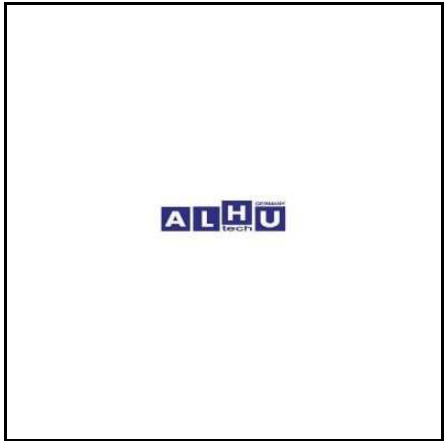

63 451 226 STABILIZER KIT

Mercedes Benz
621 320 02 28



63 451 228 STABILIZER KIT

Mercedes Benz
625 320 01 11



63 451 229 STABILIZER KIT

Mercedes Benz
625 320 04 11

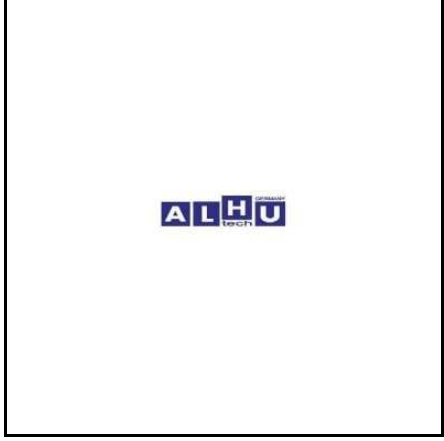

Achse / Axle

63 451 230 STABILIZER KIT

Mercedes Benz
625 320 06 11



63 451 231 STABILIZER KIT

Mercedes Benz
625 320 07 11



63 451 236 STABILIZER KIT

Mercedes Benz
647 320 00 28



63 451 237 STABILIZER KIT

Mercedes Benz
652 320 05 11



Achse / Axle

63 451 241 STABILIZER KIT

Mercedes Benz
655 320 01 11

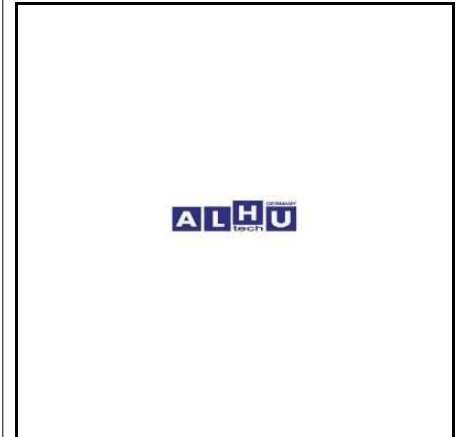

21 326 081 STABILIZER MOUNTING

Mercedes Benz
000 326 50 81

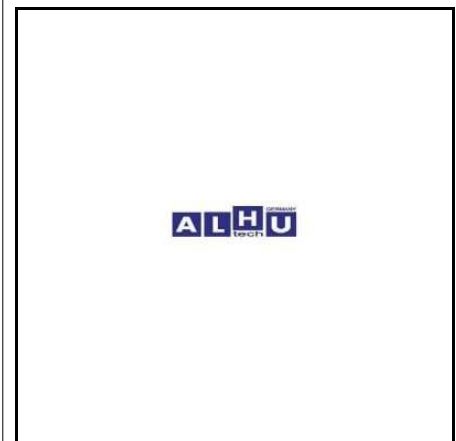

23 323 081 STABILIZER MOUNTING

Mercedes Benz
396 323 00 50

MAN
81.43271.0081

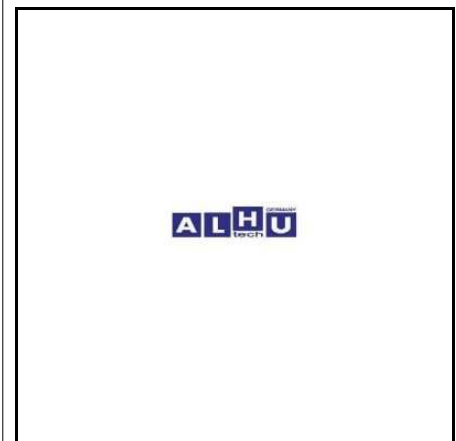

23 323 285 STABILIZER MOUNTING

Mercedes Benz
000 322 12 85
000 322 32 85

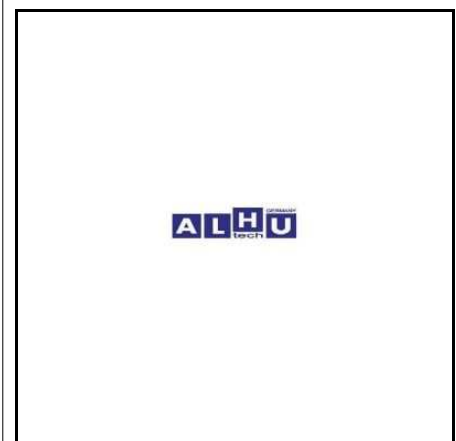

Achse / Axle

23 323 351 STABILIZER MOUNTING

Mercedes Benz
000 326 26 81



23 323 352 STABILIZER MOUNTING

Mercedes Benz
000 323 79 85



23 323 356 STABILIZER MOUNTING

Mercedes Benz
941 323 01 50



23 326 085 STABILIZER MOUNTING

Mercedes Benz
000 323 81 85



Achse / Axle

23 326 086 STABILIZER MOUNTING

Mercedes Benz
000 326 24 81

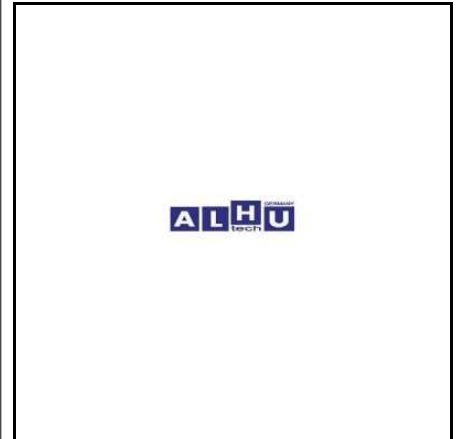

23 326 095 STABILIZER MOUNTING

Mercedes Benz
000 323 28 85

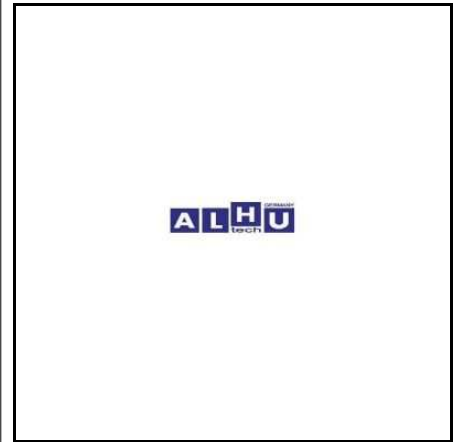

23 326 481 STABILIZER MOUNTING

Mercedes Benz
000 326 44 81

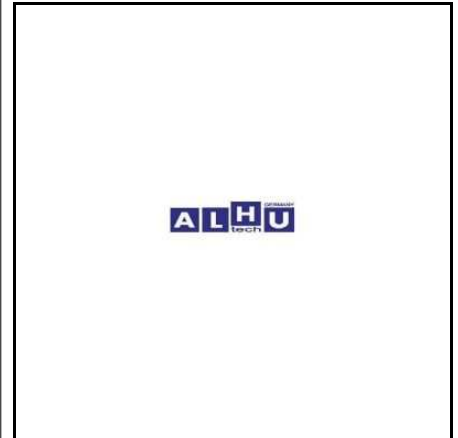

23 326 681 STABILIZER MOUNTING

Mercedes Benz
655 326 05 81



Achse / Axle

28 322 385 STABILIZER MOUNTING

Mercedes Benz
000 322 03 85



63 450 132 STABILIZER MOUNTING

Mercedes Benz
387 326 01 81



63 450 133 STABILIZER MOUNTING

Mercedes Benz
941 326 03 50



63 450 144 STABILIZER MOUNTING

Mercedes Benz
970 320 00 44

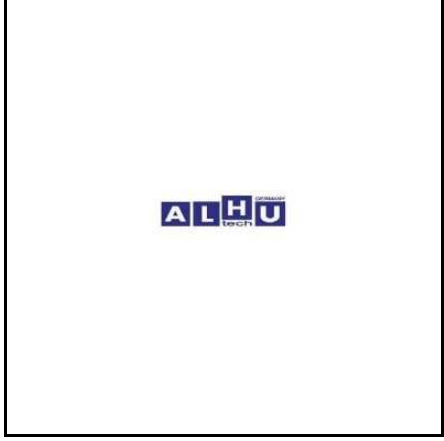

Achse / Axle

63 450 170 STABILIZER MOUNTING

Mercedes Benz
000 326 32 81



63 450 422 STABILIZER MOUNTING

Mercedes Benz
000 323 39 85



63 450 837 STABILIZER MOUNTING

Mercedes Benz
000 323 32 85



63 451 158 STABILIZER MOUNTING

Mercedes Benz
000 323 09 50



Achse / Axle

63 451 159 STABILIZER MOUNTING

Mercedes Benz
000 323 21 50



63 451 162 STABILIZER MOUNTING

Mercedes Benz
000 325 06 85



63 451 163 STABILIZER MOUNTING

Mercedes Benz
000 326 15 81



63 451 164 STABILIZER MOUNTING

Mercedes Benz
000 326 16 81



Achse / Axle

63 451 189 STABILIZER MOUNTING

Mercedes Benz
360 323 00 85



63 451 194 STABILIZER MOUNTING

Mercedes Benz
363 891 06 17



63 451 195 STABILIZER MOUNTING

Mercedes Benz
363 891 07 17



63 451 200 STABILIZER MOUNTING

Mercedes Benz
387 323 01 85



Achse / Axle

63 451 201 STABILIZER MOUNTING

Mercedes Benz
387 323 03 85



63 451 206 STABILIZER MOUNTING

Mercedes Benz
389 326 00 81



63 451 207 STABILIZER MOUNTING

Mercedes Benz
393 326 04 81



63 451 213 STABILIZER MOUNTING

Mercedes Benz
617 326 00 50



Achse / Axle

63 451 217 STABILIZER MOUNTING

Mercedes Benz
620 323 00 50



63 451 218 STABILIZER MOUNTING

Mercedes Benz
620 323 02 50



63 451 227 STABILIZER MOUNTING

Mercedes Benz
621 323 00 85



63 451 234 STABILIZER MOUNTING

Mercedes Benz
634 326 00 81



Achse / Axle

63 451 265 STABILIZER MOUNTING

Mercedes Benz
673 324 01 50



21 401 035 TAPER ROLLER BEARING

Mercedes Benz
002 981 17 05

FAG
32217



21 981 003 TAPER ROLLER BEARING

Mercedes Benz
011 981 13 05



21 353 925 THREADED RING

Mercedes Benz
346 353 09 25

MAN
81.90685.0053



Achse / Axle

63 451 678 **THREADED RING**



Mercedes Benz
346 353 08 25



616701 **THRUST WASHER**

Mercedes Benz
355 353 18 62

MAN
81.35204.0018



616705 **THRUST WASHER**

Mercedes Benz
355 353 01 76

MAN
81.90701.0722



21 215 001 **THRUST WASHER**

F 2000

Mercedes Benz
386 332 00 62

MAN
81.44215.0016



Achse / Axle

21 336 062 THRUST WASHER

Mercedes Benz
346 336 00 62

MAN
81.90711.0890

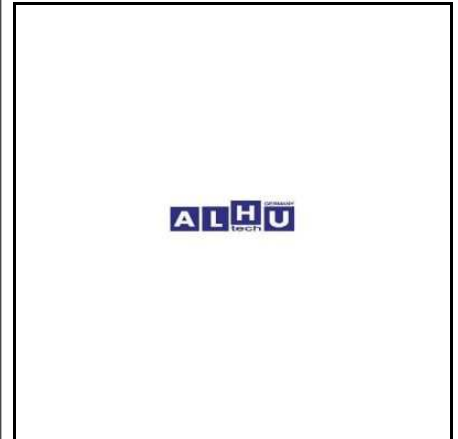

63 451 419 THRUST WASHER



Mercedes Benz
942 332 03 62

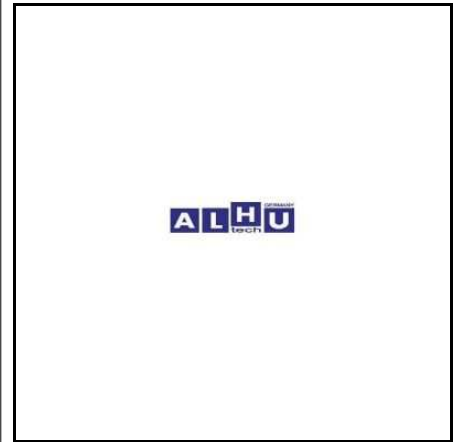

23 330 103 TIE ROD

Mercedes Benz
942 330 04 03

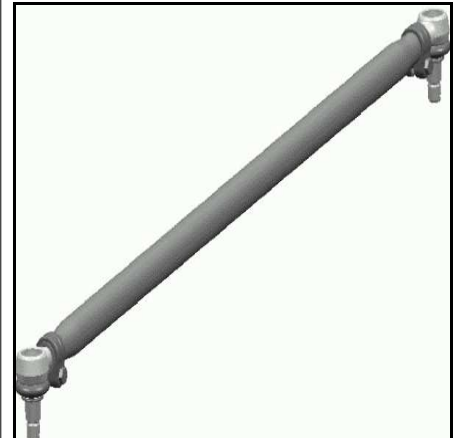

23 330 203 TIE ROD

Mercedes Benz
942 330 05 03
942 330 09 03

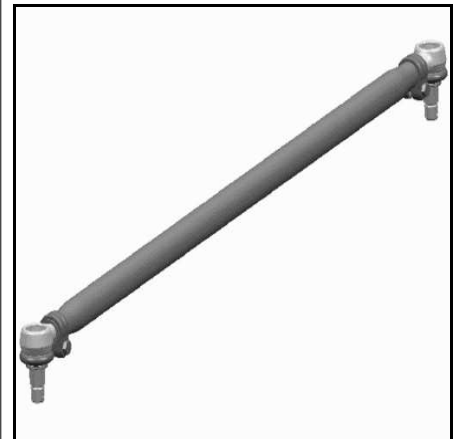

Achse / Axle

23 330 403 TIE ROD

ACTROS

Mercedes Benz
942 330 01 03
942 330 11 03



63 451 671 TIE ROD

NEW

Mercedes Benz
393 330 03 03

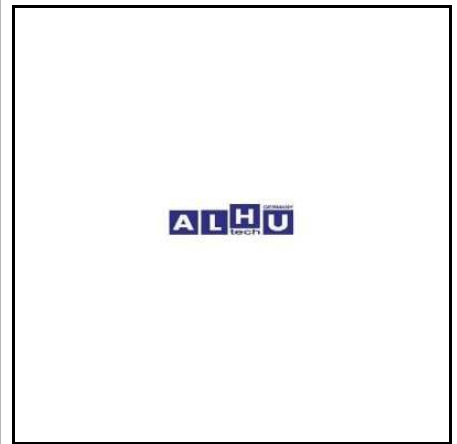

63 451 668 TRUNNION

NEW

Mercedes Benz
624 325 03 10

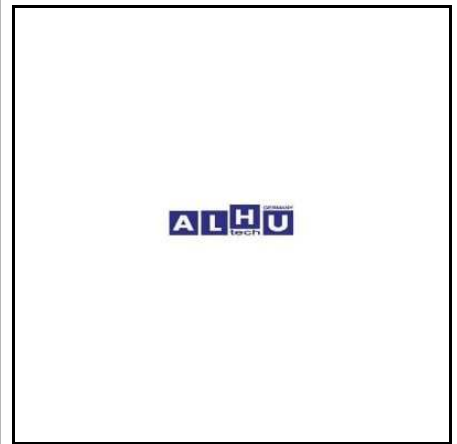

21 410 001 UNIVERSAL JOINT

Mercedes Benz
381 410 02 31

TA501
U765

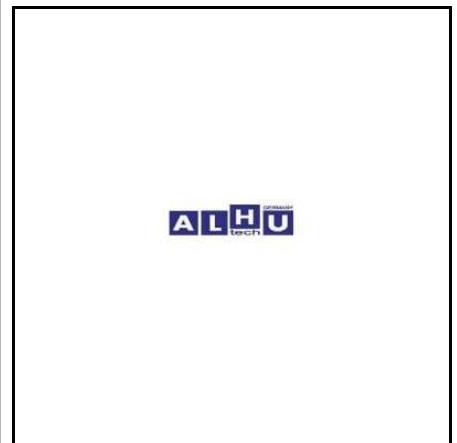

Achse / Axle

21 410 002 UNIVERSAL JOINT

Mercedes Benz
304 410 00 31



21 410 007 UNIVERSAL JOINT

Mercedes Benz
337 410 00 31
385 410 01 31



63 450 006 UNIVERSAL JOINT

Mercedes Benz
381 337 05 11



63 450 007 UNIVERSAL JOINT

Mercedes Benz
385 410 02 31



Achse / Axle

63 450 017 UNIVERSAL JOINT

Mercedes Benz
000 330 07 28

MAN
81.39108.6052



63 450 020 UNIVERSAL JOINT

ATEGO

Mercedes Benz
970 410 00 31



63 450 056 UNIVERSAL JOINT

Mercedes Benz
000 410 16 28



63 450 057 UNIVERSAL JOINT

Mercedes Benz
656 410 01 31

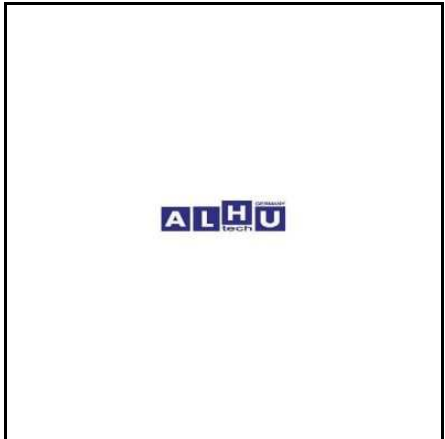

Achse / Axle

63 450 075 U-BOLT

Mercedes Benz
943 351 01 25



63 451 677 WASHER

NEW

Mercedes Benz
346 353 02 24



63 451 186 WHEEL BOLT

Mercedes Benz
352 402 00 71



63 451 274 WHEEL BOLT

Mercedes Benz
674 402 01 71



Achse / Axle

63 451 308 WHEEL BOLT

Mercedes Benz
942 401 02 71



63 451 309 WHEEL BOLT

Mercedes Benz
942 401 03 71



21 356 001 WHEEL HUB

Mercedes Benz
976 356 11 01



21 356 002 WHEEL HUB

Mercedes Benz
942 334 12 01



Achse / Axle

21 356 003 WHEEL HUB

Mercedes Benz
389 334 15 01



21 356 004 WHEEL HUB

Mercedes Benz
673 356 12 02



21 356 005 WHEEL HUB

Mercedes Benz
346 356 25 01



21 356 006 WHEEL HUB

Mercedes Benz
346 356 31 01



Achse / Axle

21 356 007 WHEEL HUB

Mercedes Benz
628 334 00 01



21 356 016 WHEEL HUB
with bearing, seals, lock ring

Mercedes Benz
943 330 11 25



21 356 017 WHEEL HUB

Mercedes Benz
975 330 04 25



21 356 028 WHEEL HUB

Mercedes Benz
346 356 29 01



Achse / Axle

21 356 029 WHEEL HUB

Mercedes Benz
624 334 10 01



21 356 030 WHEEL HUB

Mercedes Benz
668 350 00 35

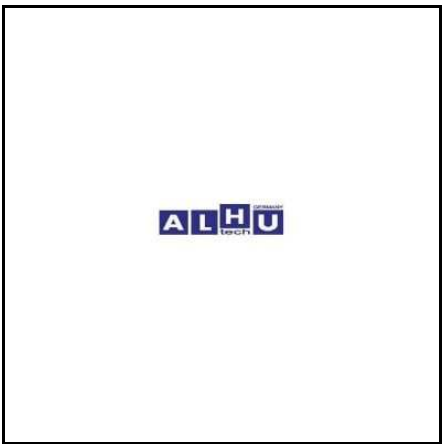

21 356 032 WHEEL HUB

Mercedes Benz
946 356 02 01

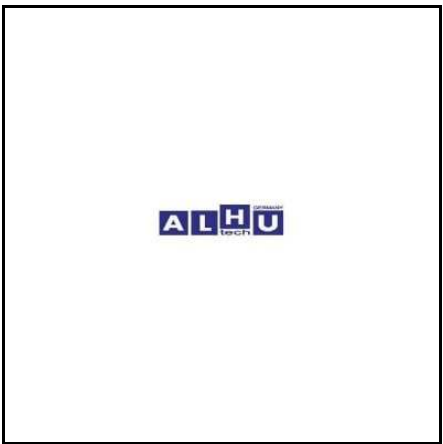

21 356 033 WHEEL HUB

Mercedes Benz
946 356 07 01

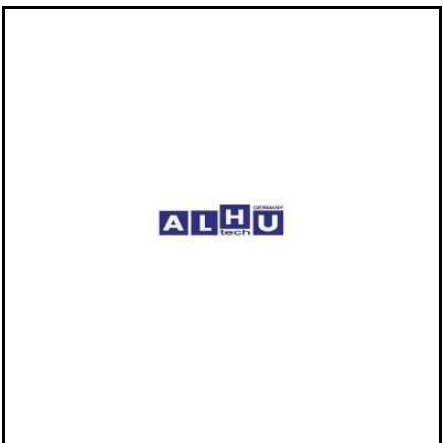

Achse / Axle

21 356 034 WHEEL HUB

Mercedes Benz
949 334 08 01



21 356 036 WHEEL HUB

Mercedes Benz
942 334 14 01



21 356 041 WHEEL HUB

Mercedes Benz
970 350 03 35



21 356 015 WHEEL HUB ASSEMBLY
with bearing, seals, lock ring

Mercedes Benz
000 350 05 35



Achse / Axle

63 451 673 12-POINT COLLAR NUT



Mercedes Benz
385 351 05 72

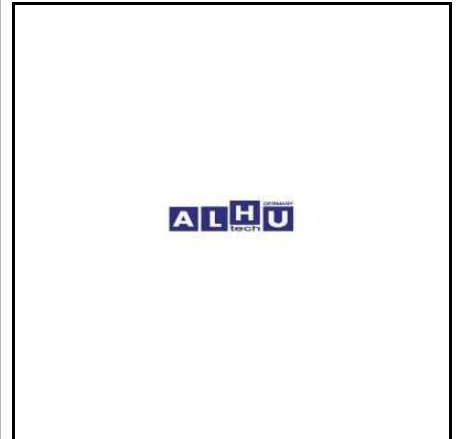

63 451 680 12-POINT COLLAR NUT



Mercedes Benz
385 351 06 72



Bremse / Brake

13 927 001 ABS SENSOR
front
SPRINTER

Mercedes Benz
901 542 08 17
901 542 17 17

VW
2D0 927 808

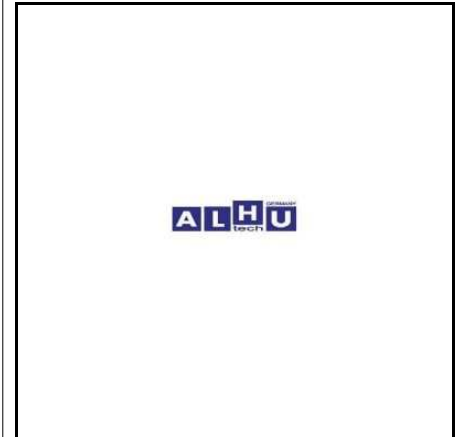

13 927 002 ABS SENSOR
rear
SPRINTER

Mercedes Benz
901 542 11 17

VW
2D0 927 807 A

Bosch
0 265 004 010

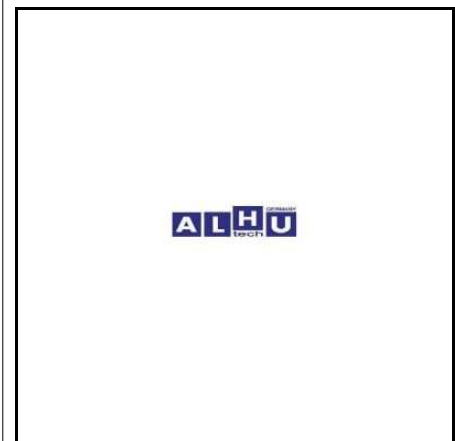

13 927 003 ABS SENSOR

Mercedes Benz
002 542 38 18

Wabco
441.032.920.0

DAF
1518009

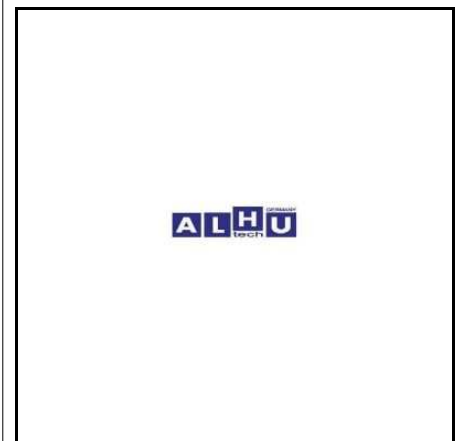

22 542 717 ABS SENSOR

Mercedes Benz
013 542 67 17

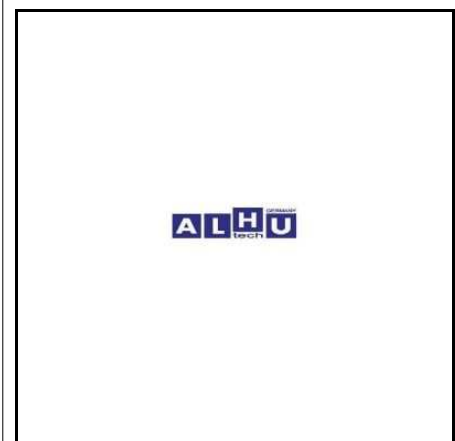

Bremse / Brake

23 752 808 ABS SENSOR

Mercedes Benz
002 542 31 18

Wabco
441.032.808.0



63 450 754 ABS SENSOR

Mercedes Benz
012 542 47 17

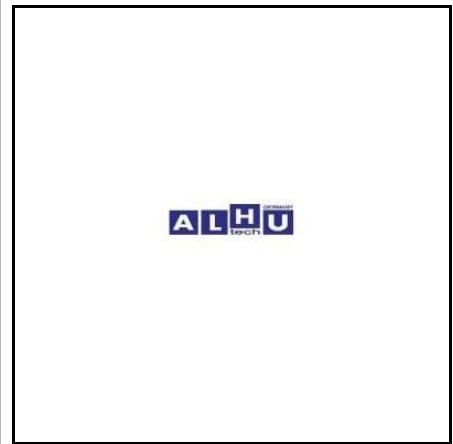

63 450 772 ABS SENSOR

Mercedes Benz
001 153 02 20

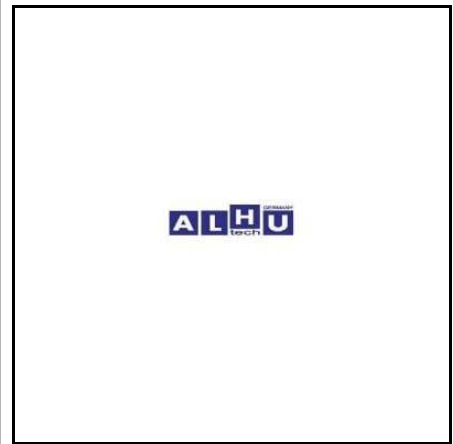

63 450 773 ABS SENSOR

Mercedes Benz
001 153 04 20

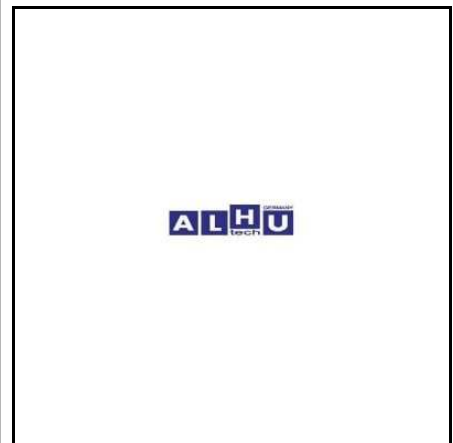

Bremse / Brake

63 450 785 ABS SENSOR

Mercedes Benz
000 542 97 18

Wabco
441.032.727.0



63 450 786 ABS SENSOR

Mercedes Benz
356 540 06 17

Wabco
441.032.765.0



63 450 787 ABS SENSOR

Mercedes Benz
000 540 34 17

Wabco
441.032.767.0



63 450 788 ABS SENSOR

Mercedes Benz
002 542 22 18

Wabco
441.032.851.0



Bremse / Brake

63 450 789 ABS SENSOR

Mercedes Benz
001 542 88 18

Wabco
441.032.921.0

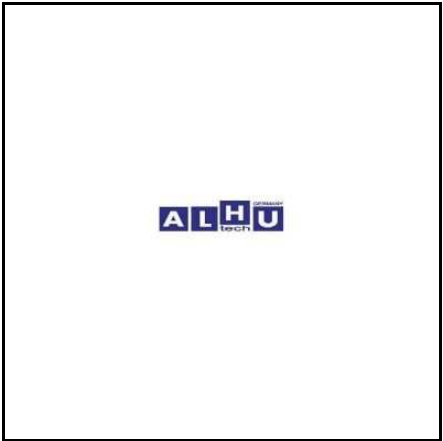

63 450 790 ABS SENSOR

Mercedes Benz
001 542 84 18

Wabco
441.032.923.0



63 450 791 ABS SENSOR

Mercedes Benz
003 542 35 18
004 542 45 18

Wabco
441.032.941.0

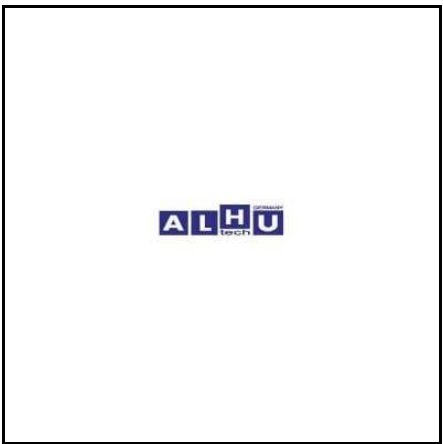

63 450 792 ABS SENSOR

Mercedes Benz
001 542 85 18
001 542 89 18

Wabco
441.032.942.0

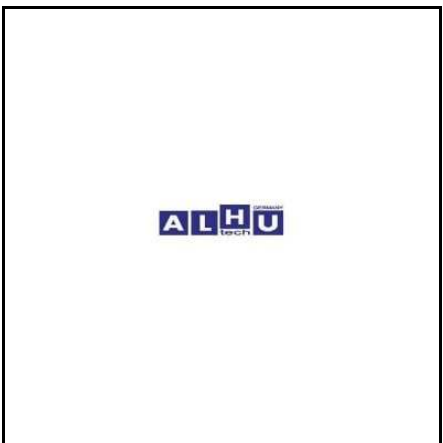

Bremse / Brake

63 450 793 ABS SENSOR

Mercedes Benz
003 542 46 18
004 542 46 18

Wabco
441.032.946.0



63 450 794 ABS SENSOR

Mercedes Benz
003 542 45 18
004 542 47 18

Wabco
441.032.947.0



24 000 001 ABS SOLENOID VALVE

Mercedes Benz 004 429 61 44	Scania 369543
---------------------------------------	-------------------------

KNORR
II16278



21 130 515 AIR COMPRESSOR

Mercedes Benz
447 130 05 15



Bremse / Brake

22 130 001 AIR COMPRESSOR

Mercedes Benz
447 130 28 15



22 130 002 AIR COMPRESSOR

Mercedes Benz
447 130 30 15



21 130 012 AIR COMPRESSOR BUSHING

Mercedes Benz
000 131 31 50



21 130 031 AIR COMPRESSOR BUSHING

Mercedes Benz
000 131 42 50

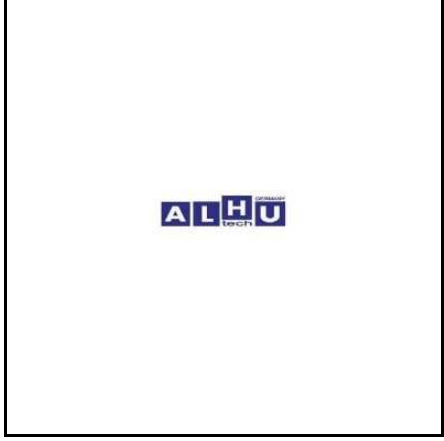

Bremse / Brake

21 131 011 AIR COMPRESSOR BUSHING

Mercedes Benz
000 131 30 50

MAN
81.54130.0011



21 130 017 AIR COMPRESSOR CONROD

Mercedes Benz
541 131 01 17



21 130 025 AIR COMPRESSOR CONROD

Mercedes Benz
000 131 18 17

MAN
81.54106.0006



21 130 067 AIR COMPRESSOR CONROD



Mercedes Benz
000 131 24 17

Wabco
911.145.737.2



Bremse / Brake

21 130 071 AIR COMPRESSOR CONROD



KNORR
1194119SP

Volvo
3090257

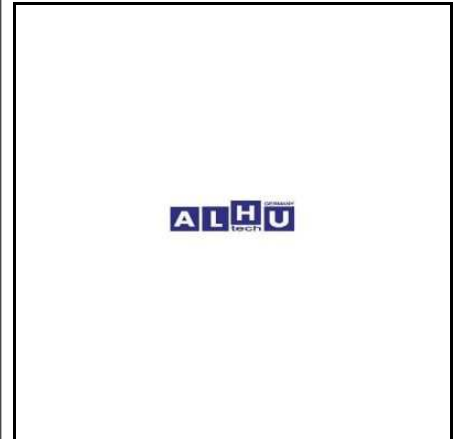

21 130 076 AIR COMPRESSOR CONROD



KNORR
SEB00967004

Volvo
3097151

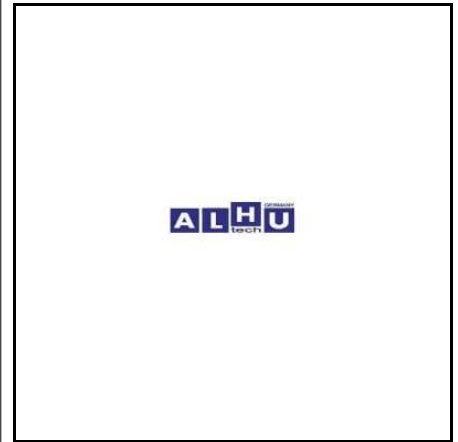

21 130 816 AIR COMPRESSOR CONROD

Mercedes Benz
403 130 28 16

MAN
51.54106.6013

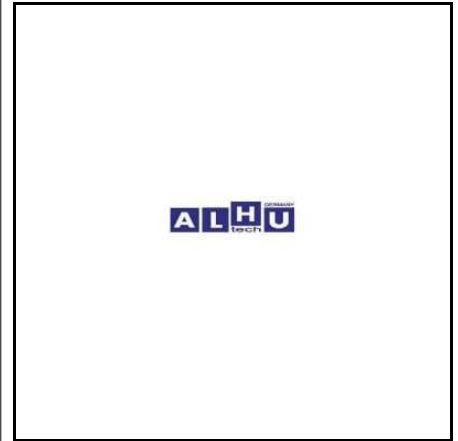

24 130 916 AIR COMPRESSOR CONROD

Mercedes Benz
442 131 00 17
442 131 02 17
541 131 00 17

MAN
51.54106.6021

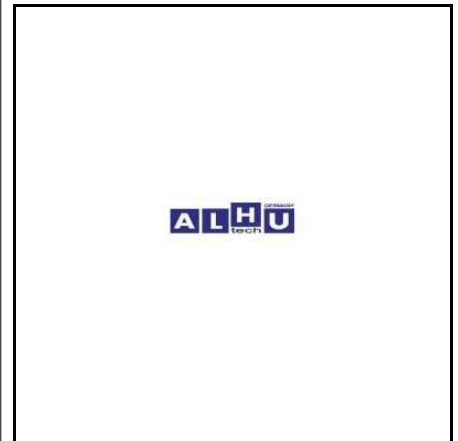

Bremse / Brake

21 130 014 AIR COMPRESSOR CRANKSHAFT

Mercedes Benz
541 130 02 14

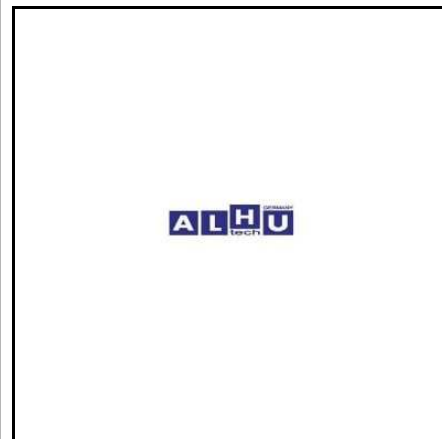

21 130 020 AIR COMPRESSOR CRANKSHAFT

Mercedes Benz
447 130 00 14

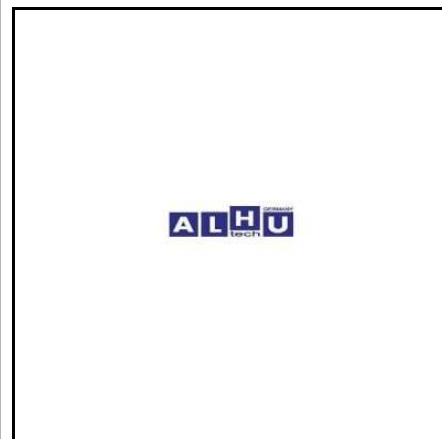

21 130 114 AIR COMPRESSOR CRANKSHAFT

Mercedes Benz
442 130 01 14

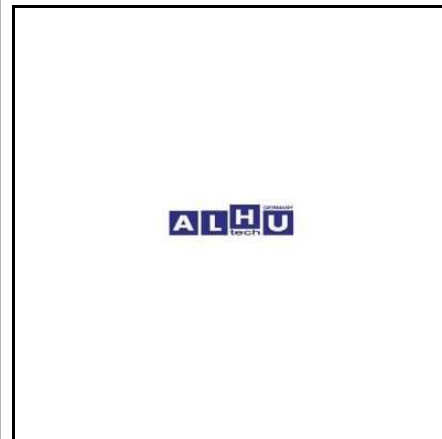

21 131 016 AIR COMPRESSOR CRANKSHAFT

Mercedes Benz
403 131 07 16

MAN
51.54113.0017



Bremse / Brake

21 131 116 AIR COMPRESSOR CRANKSHAFT

Mercedes Benz
403 131 10 16

MAN
51.54113.5027

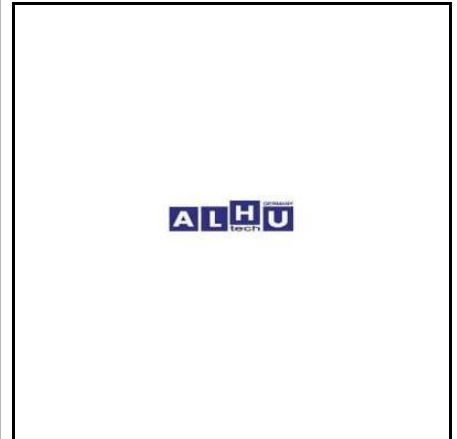

21 130 051 AIR COMPRESSOR CRANKSHAFT SCRE

Mercedes Benz
403 990 00 10

MAN
51.90020.0131



21 130 019 AIR COMPRESSOR CYLINDER HEAD

Mercedes Benz
000 130 26 19
407 130 05 19

MAN
51.54114.6054

KNORR
ZB4275

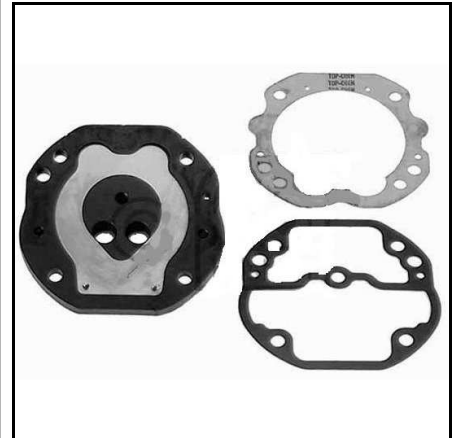

21 130 219 AIR COMPRESSOR CYLINDER HEAD

Mercedes Benz
442 130 32 19

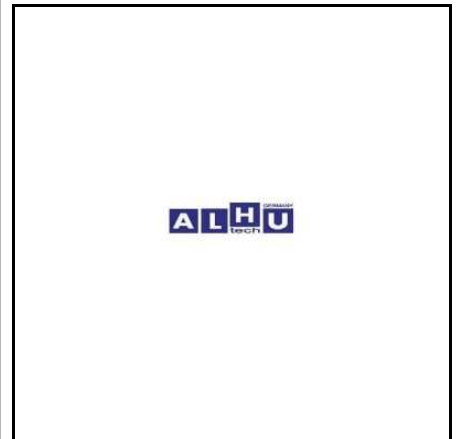

Bremse / Brake

21 130 037 AIR COMPRESSOR CYLINDER HEAD

Mercedes Benz
442 131 05 19

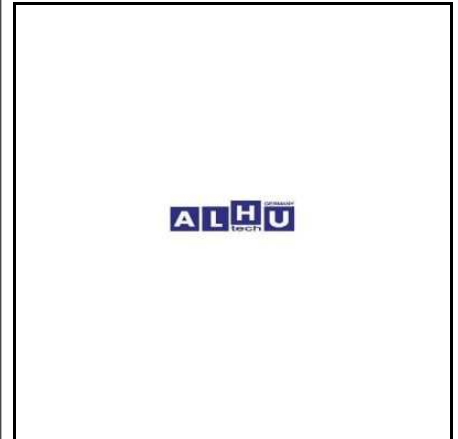

21 130 069 AIR COMPRESSOR CYLINDER HEAD



Mercedes Benz
001 130 30 15

Wabco
411.553.921.2

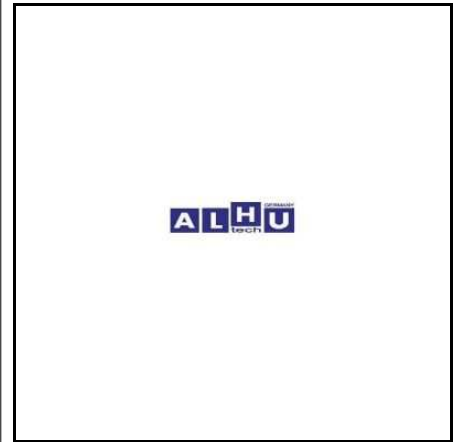

21 130 119 AIR COMPRESSOR CYLINDER HEAD

Mercedes Benz
541 131 06 19
541 131 11 19

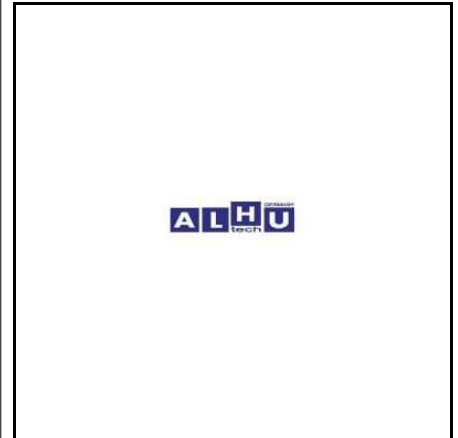

21 130 140 AIR COMPRESSOR CYLINDER HEAD

Wabco
412.636.920.2

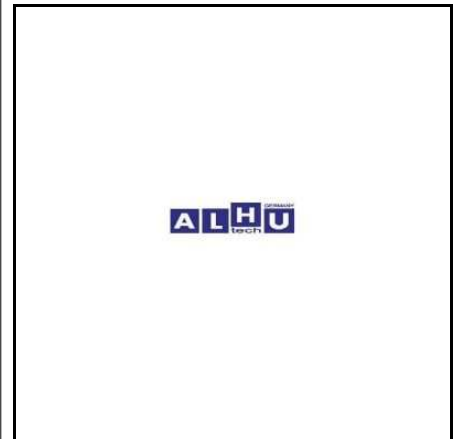

Bremse / Brake

21 130 142 AIR COMPRESSOR CYLINDER HEAD

Mercedes Benz

000 131 51 19

Wabco

411.154.800.2

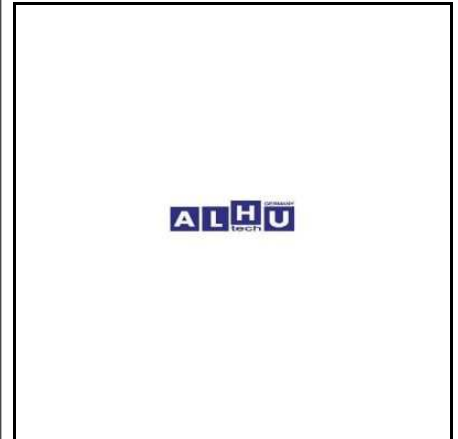

21 130 319 AIR COMPRESSOR CYLINDER HEAD

Mercedes Benz

352 130 03 19

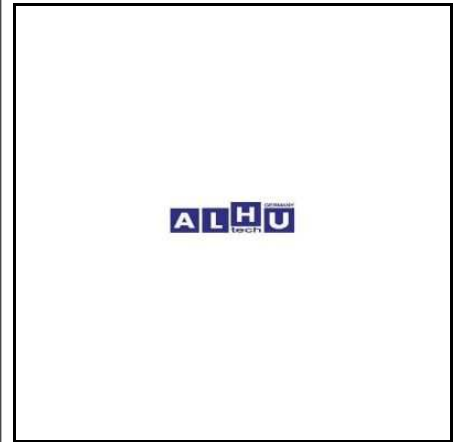

21 130 719 AIR COMPRESSOR CYLINDER HEAD

vertical

Mercedes Benz

541 130 27 19



21 130 919 AIR COMPRESSOR CYLINDER HEAD

horizontal

Mercedes Benz

541 130 29 19



Bremse / Brake

21 130 053 AIR COMPRESSOR CYLINDER LINER

Mercedes Benz
000 131 28 02

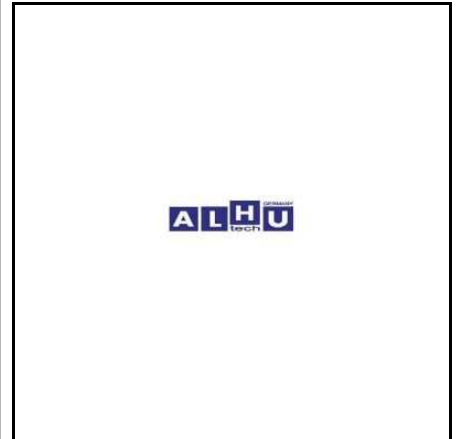

21 130 045 AIR COMPRESSOR FLANGE

Mercedes Benz
403 130 16 45

MAN
51.54130.6011



21 130 445 AIR COMPRESSOR FLANGE

Mercedes Benz
442 130 01 45



21 131 142 AIR COMPRESSOR FLANGE

Mercedes Benz
541 131 01 42



Bremse / Brake

21 130 032 AIR COMPRESSOR FOLLOWER

Mercedes Benz
000 132 14 10



21 130 026 AIR COMPRESSOR GASKET

Mercedes Benz
541 131 06 80



21 130 036 AIR COMPRESSOR GASKET

Mercedes Benz
447 131 02 80



21 130 056 AIR COMPRESSOR GASKET

Mercedes Benz
407 131 05 80

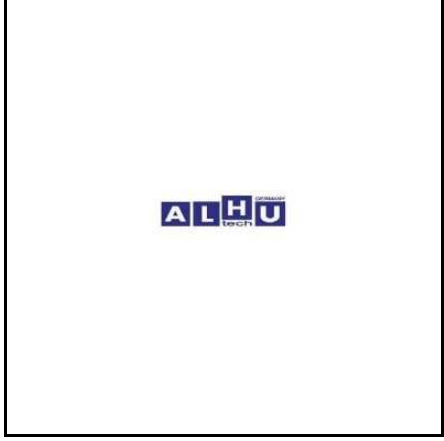

Bremse / Brake

21 131 131 AIR COMPRESSOR GASKET

Mercedes Benz
541 131 01 31



21 130 061 AIR COMPRESSOR GASKET KIT

Mercedes Benz
442 130 00 20



21 130 029 AIR COMPRESSOR GASKET SET

Mercedes Benz
000 130 68 15

Wabco
411.154.000.2



21 130 615 AIR COMPRESSOR GASKET SET

Mercedes Benz
000 130 76 15



Bremse / Brake

21 130 022 AIR COMPRESSOR GEAR

Mercedes Benz
447 132 02 05



24 130 010 AIR COMPRESSOR HOUSING

Mercedes Benz
407 130 06 10

MAN
51.54112.6008



21 130 052 AIR COMPRESSOR PISTON

Mercedes Benz
000 130 19 17



21 130 062 AIR COMPRESSOR PISTON

Mercedes Benz
000 130 34 17

Wabco
911.501.624.2

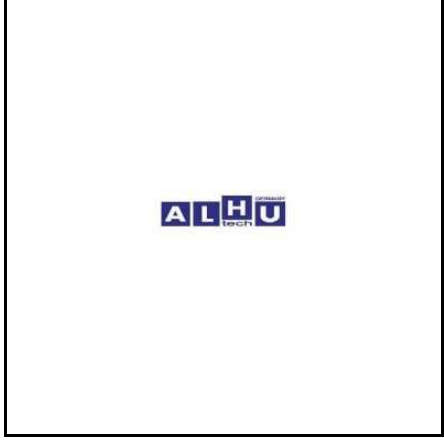

Bremse / Brake

21 130 008 AIR COMPRESSOR PISTON ASSEMBLY

Mercedes Benz
442 130 00 08

MAN
51.54105.6006

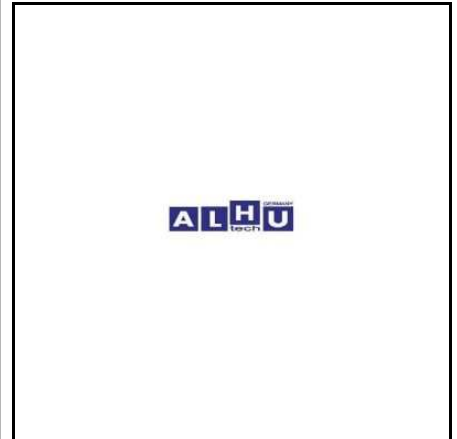

21 130 041 AIR COMPRESSOR PISTON ASSEMBLY

Mercedes Benz
447 130 00 08



21 130 608 AIR COMPRESSOR PISTON ASSEMBLY

Mercedes Benz
402 130 06 08

MAN
51.54105.6008

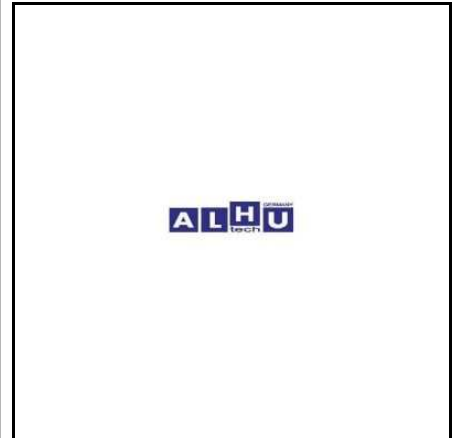

21 130 108 AIR COMPRESSOR PISTON ASSY

Mercedes Benz
441 130 00 08

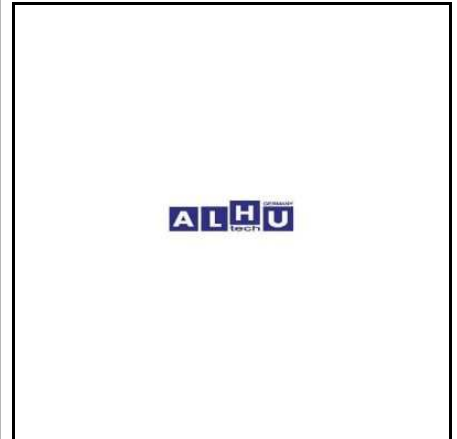

Bremse / Brake

21 130 208 AIR COMPRESSOR PISTON ASSY

Mercedes Benz
541 130 00 08



21 130 308 AIR COMPRESSOR PISTON ASSY

Mercedes Benz
541 130 01 08



21 130 408 AIR COMPRESSOR PISTON ASSY

Mercedes Benz
352 130 01 08



21 130 068 AIR COMPRESSOR PISTON RING SET



Mercedes Benz
001 131 11 11



Bremse / Brake

21 130 028 AIR COMPRESSOR REPAIR KIT

Mercedes Benz
000 130 49 20

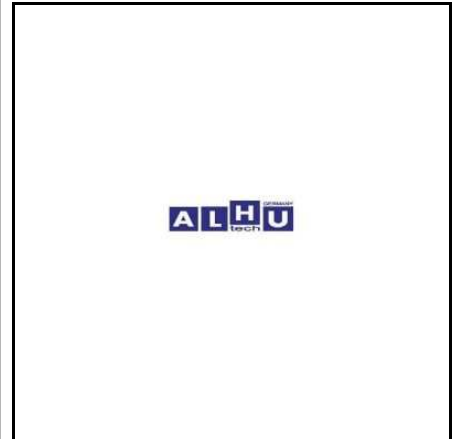

21 130 070 AIR COMPRESSOR REPAIR KIT



Wabco
411.553.923.2



21 130 120 AIR COMPRESSOR REPAIR KIT

Mercedes Benz
441 130 02 20



21 130 132 AIR COMPRESSOR REPAIR KIT

Mercedes Benz
000 130 13 20

MAN
81.54124.0005

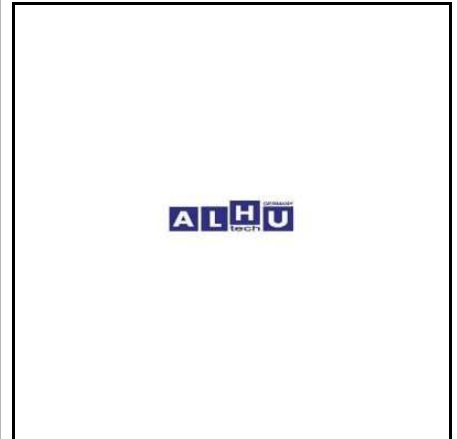

Bremse / Brake

21 130 220 AIR COMPRESSOR REPAIR KIT

Mercedes Benz
402 130 02 20



21 130 261 AIR COMPRESSOR REPAIR KIT

Mercedes Benz
001 130 26 15



21 130 018 AIR COMPRESSOR VALVE

Mercedes Benz
442 130 11 20



21 130 057 AIR COMPRESSOR VALVE PLATE

Mercedes Benz
447 130 00 20

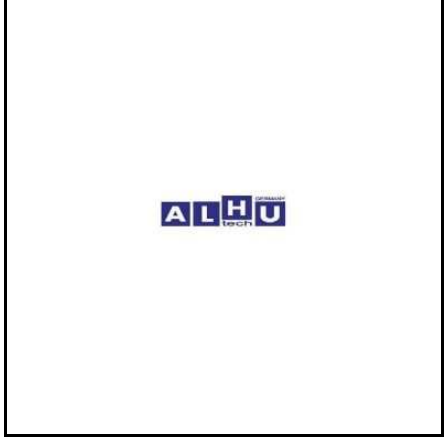

Bremse / Brake

21 130 320 AIR COMPRESSOR VALVE PLATE KIT

Mercedes Benz
402 130 03 20



21 130 620 AIR COMPRESSOR VALVE PLATE KIT

with gasket

Mercedes Benz
541 130 06 20



21 130 720 AIR COMPRESSOR VALVE PLATE KIT

Mercedes Benz
442 130 07 20

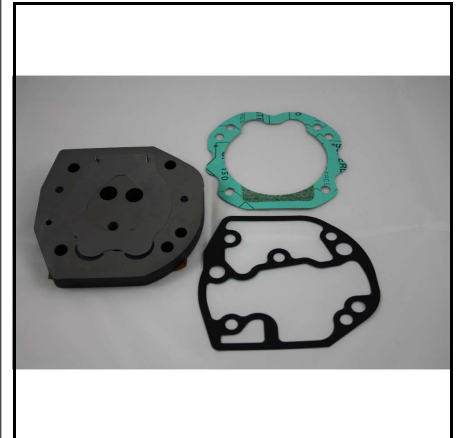

24 500 006 AIR DRYER

Mercedes Benz
001 431 78 15
001 431 81 15

Wabco
932.500.006.0

KNORR
II38310FN00

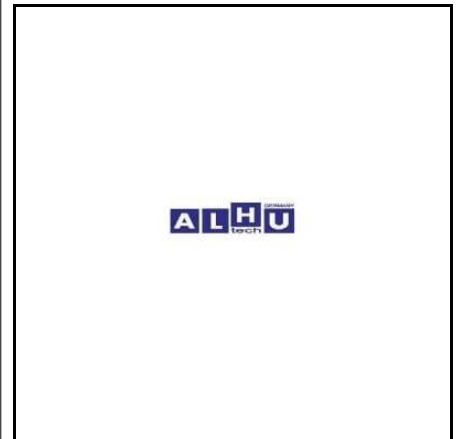

Bremse / Brake

21 350 001 AIR DRYER CARTRIDGE

Mercedes Benz
000 429 37 95
000 430 09 69

MAN
82.52102.0013

KNORR
II40100F

Mann + Hummel
TB 1374X

weitere/another

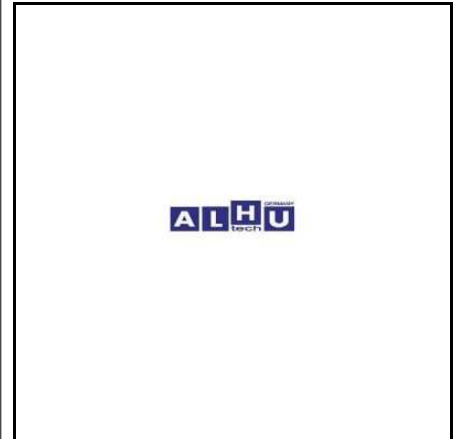

21 350 003 AIR DRYER CARTRIDGE

Mercedes Benz
000 429 56 95

Mann + Hummel
TB 1394/1 X

MAN
81.52108.6025

Volvo
20557234
20972915
21508133

weitere/another

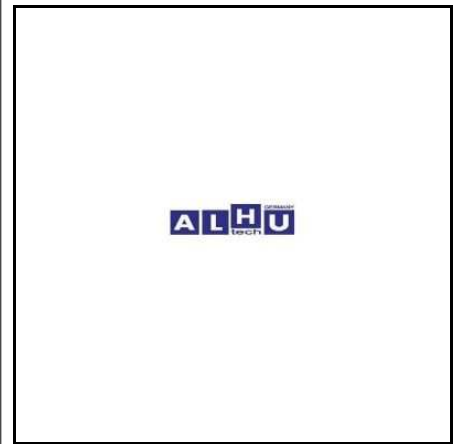

21 350 008 AIR DRYER CARTRIDGE

Mercedes Benz
000 429 46 95

Iveco
42535061

TA501
78964

MAN
81.52102.6146

weitere/another



23 500 001 AIR SPRING VALVE

left

Mercedes Benz
000 328 20 30

Scania
279771
677279

KNORR
0500005001000



Bremse / Brake

23 500 002 AIR SPRING VALVE

right

Mercedes Benz

000 328 21 30
000 328 37 30

Scania

279772
677280

KNORR

0500005002000



23 500 004 AIR SPRING VALVE

Mercedes Benz

000 328 32 30

Wabco

464.006.100.0

KNORR

180093

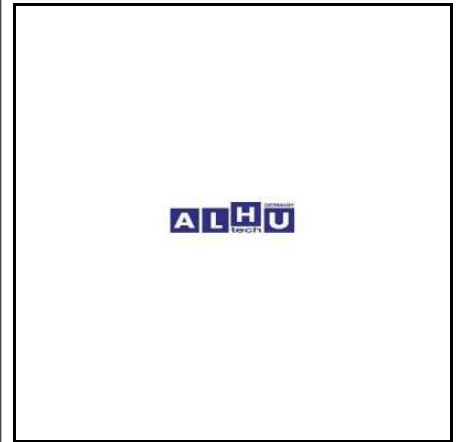

23 500 008 AIR SPRING VALVE

Mercedes Benz

000 328 23 30

Volvo

1576736

MAN

84.43610.6006

Wabco

464.002.330.0

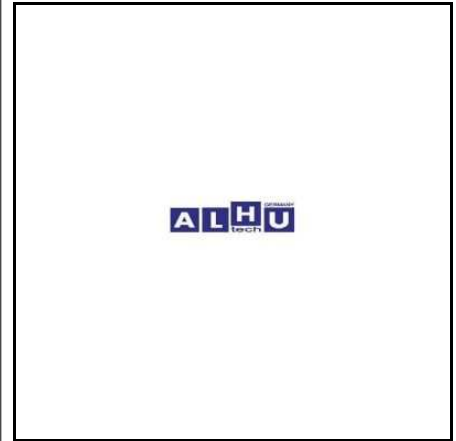

23 500 011 AIR SPRING VALVE

Mercedes Benz

000 328 45 30

Wabco

464.007.011.0



Bremse / Brake

23 500 014 AIR SPRING VALVE

KNORR
SV1313

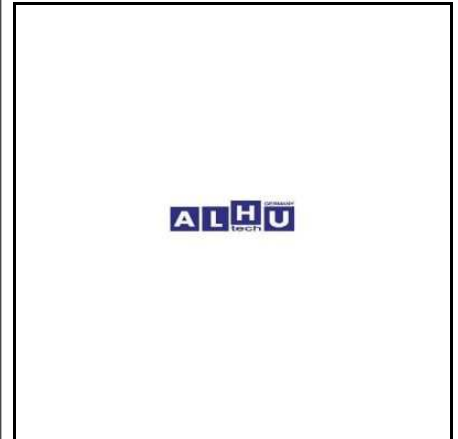

23 500 018 AIR SPRING VALVE

KÄSSBOHRER
8285086000

KNORR
I136108

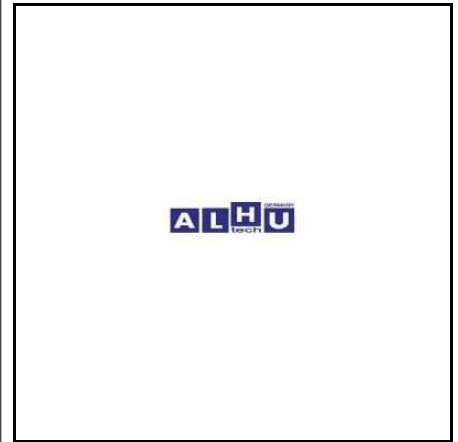

23 500 104 AIR SPRING VALVE

Mercedes Benz
000 328 42 30



23 500 105 AIR SPRING VALVE

Mercedes Benz
000 328 39 30

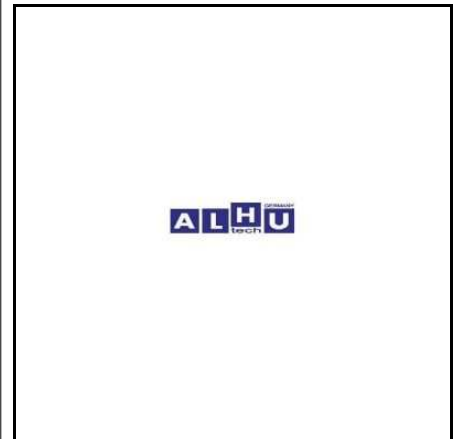

Bremse / Brake

63 451 317 BOLT

Mercedes Benz
945 421 00 74



63 451 679 BRAKE ANCHOR PLATE

 **Mercedes Benz**
346 421 31 06

MAN
81.50202.0108



06 501 568 BRAKE ANCHOR PLATE

Mercedes Benz
346 423 09 06

MAN
81.50202.0127



22 010 004 BRAKE CAMSHAFT

Mercedes Benz
623 421 01 36

MAN
81.50301.0223



Bremse / Brake

22 010 005 BRAKE CAMSHAFT

Mercedes Benz
623 421 02 36

MAN
81.50301.0224

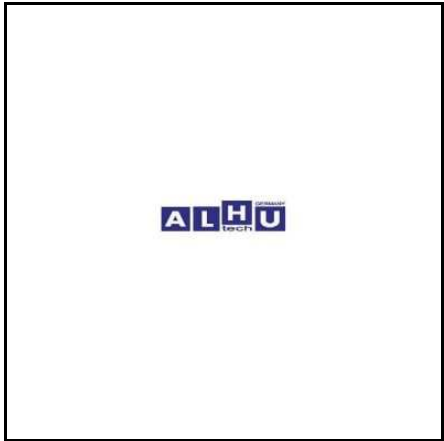

22 010 006 BRAKE CAMSHAFT

Mercedes Benz
623 423 01 36

MAN
81.50301.0113



22 010 007 BRAKE CAMSHAFT

Mercedes Benz
623 423 02 36

MAN
81.50301.0112



22 010 008 BRAKE CAMSHAFT

Mercedes Benz
305 421 18 36

MAN
81.50301.0225

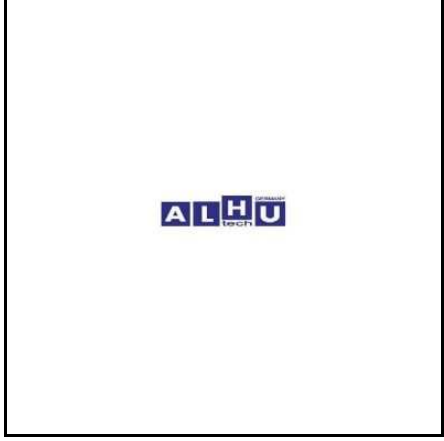

Bremse / Brake

22 010 009 BRAKE CAMSHAFT

Mercedes Benz
305 421 19 36

MAN
81.50301.0226

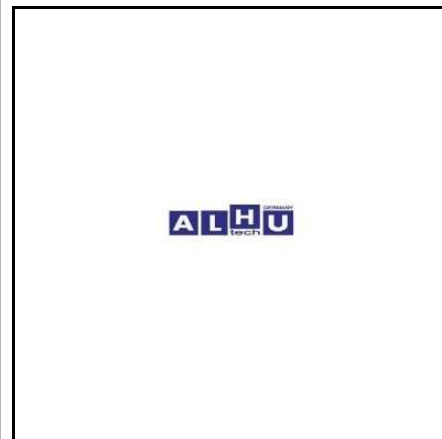

63 450 272 BRAKE CAMSHAFT
left

Mercedes Benz
000 423 15 36

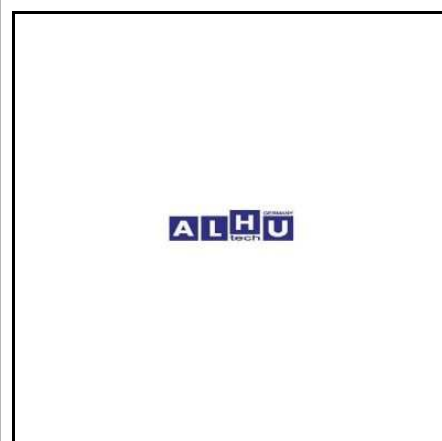

63 450 273 BRAKE CAMSHAFT
right

Mercedes Benz
000 423 16 36

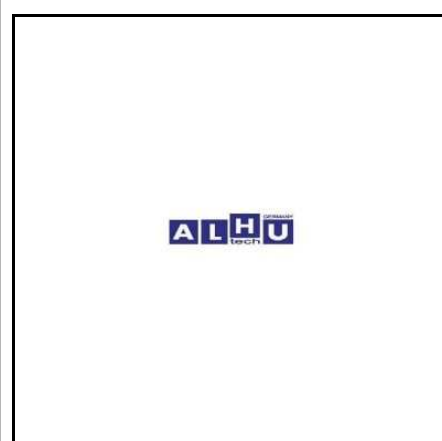

22 421 001 BRAKE DISC

Mercedes Benz
942 421 21 12

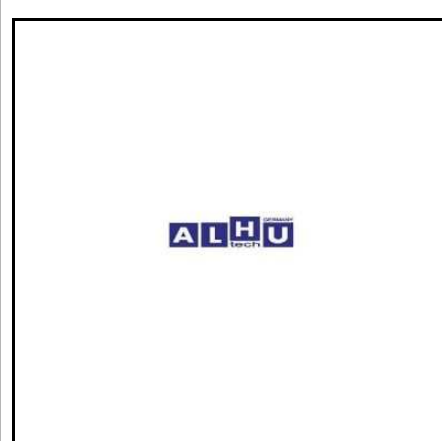

Bremse / Brake

63 450 990 BRAKE HOSE

Mercedes Benz
000 429 73 35



69 030 000 BRAKE PAD SET

 complete with accessoires **MERITOR** brake

Textar
29030 07



69 202 000 BRAKE PAD SET

 complete with accessoires **KNORR** brake

KNORR
K046771K50

Textar
29202 02



22 001 001 BRAKE PIN KIT

Mercedes Benz
307 420 40 02



Bremse / Brake

22 010 011 BRAKE PIN REPAIR KIT

Mercedes Benz 000 420 22 82	KNORR 11328090062
DAF 1448915	MAN 81.50822.6009



24 420 019 BRAKE SHOE
STEEL, 410 X 160 MM
F 2000

Mercedes Benz 393 420 25 19
MAN 81.50201.6190



24 420 319 BRAKE SHOE
STEEL, 180 MM

Mercedes Benz 659 420 03 19



24 420 519 BRAKE SHOE
CAST IRON, 410 x 220 mm
TGA TGS TGX

Mercedes Benz 659 420 05 19
MAN 81.50201.6218



Bremse / Brake

22 001 002 BRAKE SHOE PIN

Mercedes Benz
497 421 00 74

MAN
81.50212.0036



24 420 039 BRAKE SHOE PIN KIT

Mercedes Benz
335 420 00 39



24 420 049 BRAKE SHOE SLEEVE REPAIR KIT

Mercedes Benz
307 420 03 39



22 000 032 BRAKE SHOE SPRING

Mercedes Benz
617 993 06 10

MAN
81.97610.0208

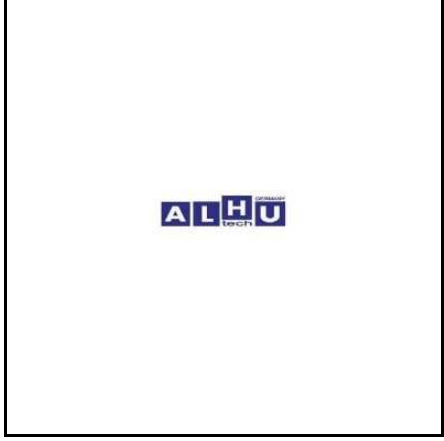

Bremse / Brake

22 000 044 BRAKE SHOE SPRING

Mercedes Benz
346 993 08 10



63 451 270 BRAKE SHOE SPRING

Mercedes Benz
673 993 04 10



63 451 318 BRAKE SHOE SPRING

Mercedes Benz
945 993 00 10



13 540 001 BRAKE WEAR INDICATOR

Mercedes Benz
670 540 00 17



Bremse / Brake

13 540 021 BRAKE WEAR INDICATOR

Mercedes Benz

901 540 02 17
901 540 03 17

VW

2D0 919 351 A



13 540 041 BRAKE WEAR INDICATOR

Mercedes Benz

669 540 04 17



13 540 061 BRAKE WEAR INDICATOR

Mercedes Benz

460 540 06 17

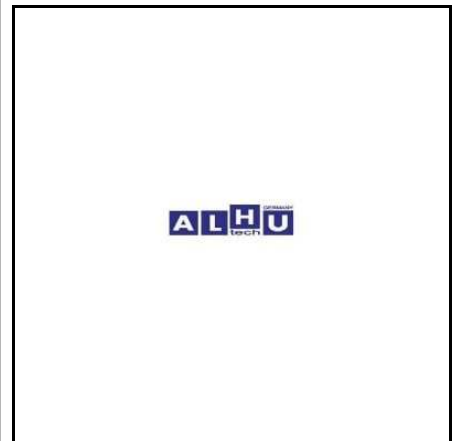

13 540 062 BRAKE WEAR INDICATOR

Mercedes Benz

601 540 06 17

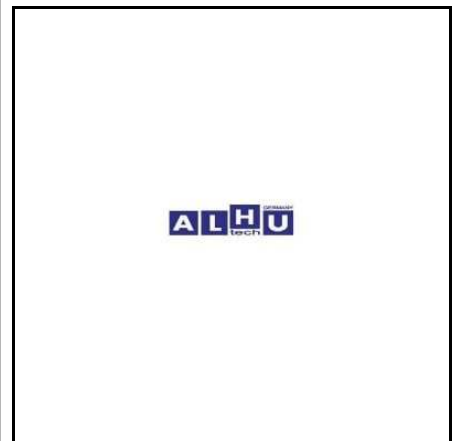

Bremse / Brake

13 540 072 BRAKE WEAR INDICATOR

Mercedes Benz
677 540 07 17



13 540 073 BRAKE WEAR INDICATOR

Mercedes Benz
669 540 07 17



13 540 081 BRAKE WEAR INDICATOR

Mercedes Benz
669 540 08 17



13 540 117 BRAKE WEAR INDICATOR

Mercedes Benz
901 540 00 17
901 540 01 17

VW
2D0 919 351



Bremse / Brake

13 540 131 BRAKE WEAR INDICATOR

Mercedes Benz
601 540 13 17

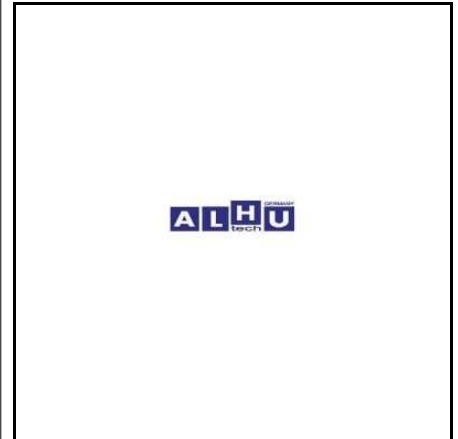

13 540 320 BRAKE WEAR INDICATOR

Mercedes Benz
906 540 13 17



13 540 356 BRAKE WEAR INDICATOR

Mercedes Benz
356 540 00 17

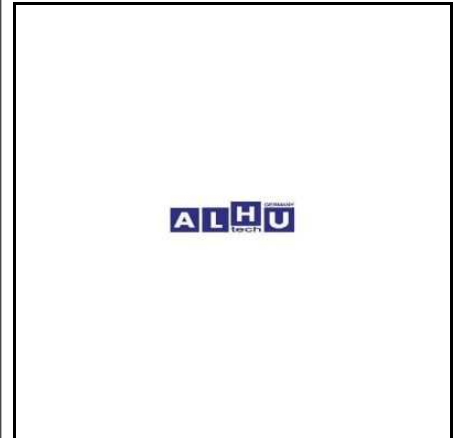

13 540 517 BRAKE WEAR INDICATOR

W220

Mercedes Benz
164 540 10 17
220 540 15 17
639 540 15 17



Bremse / Brake

13 540 817 BRAKE WEAR INDICATOR

Mercedes Benz
677 540 08 17

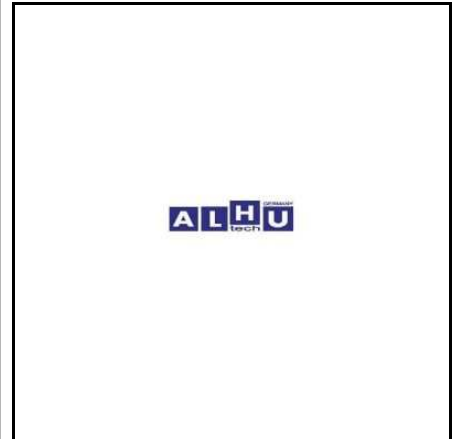

13 540 835 BRAKE WEAR INDICATOR

Mercedes Benz
639 540 14 17



13 540 838 BRAKE WEAR INDICATOR

Mercedes Benz
906 540 14 17
906 540 15 17

VW
2E0 906 206 C

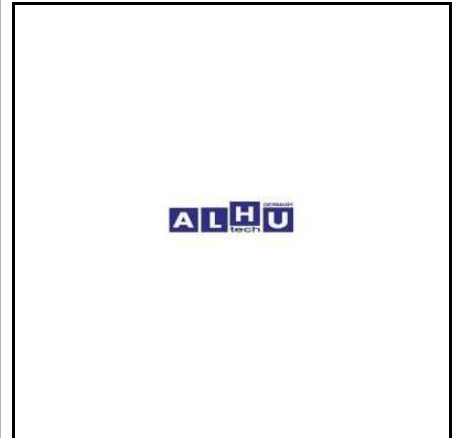

13 540 917 BRAKE WEAR INDICATOR

Mercedes Benz
669 540 09 17



Bremse / Brake

13 542 017 BRAKE WEAR INDICATOR

Mercedes Benz
435 542 00 17

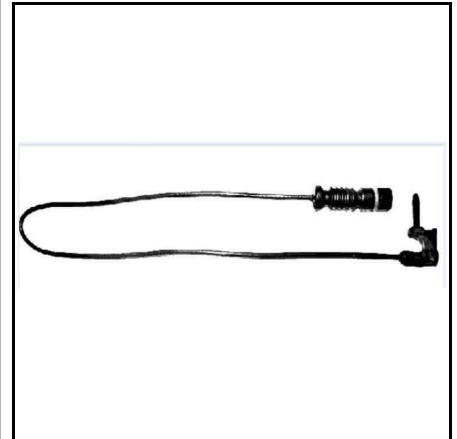

22 420 007 CALIPER BOLT REPAIR KIT

F 2000

Mercedes Benz
000 420 02 76

MAN
81.50802.6009

TA501
SJ 4011



22 420 008 CALIPER COVER SET

Mercedes Benz
000 423 00 82

MAN
81.50802.6007

TA501
SJ 1212

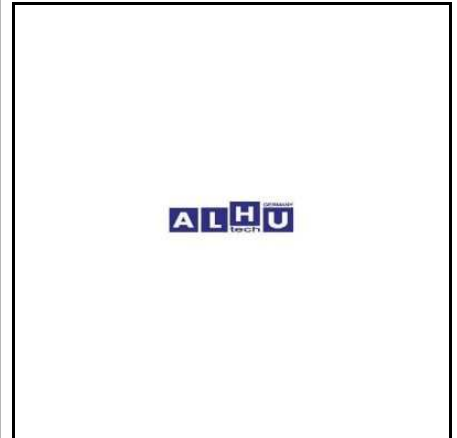

63 450 548 CHARGING VALVE

Mercedes Benz
005 429 18 44

Wabco
434.100.249.0

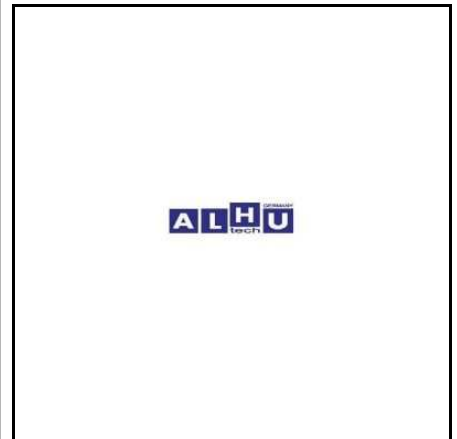

Bremse / Brake

24 051 126 CLUTCH BOOSTER

Mercedes Benz
001 295 67 06

KNORR
193582

KHD
42061949

Wabco
970.051.126.0



24 051 137 CLUTCH BOOSTER

Mercedes Benz
000 295 00 18

Wabco
970.051.137.0



24 051 158 CLUTCH BOOSTER

Mercedes Benz
000 295 15 18

Wabco
970.051.158.0

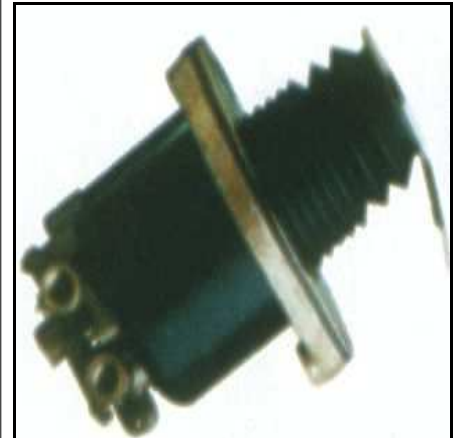

24 051 159 CLUTCH BOOSTER

Mercedes Benz
000 295 09 18

Wabco
970.051.159.0

KNORR
1114195

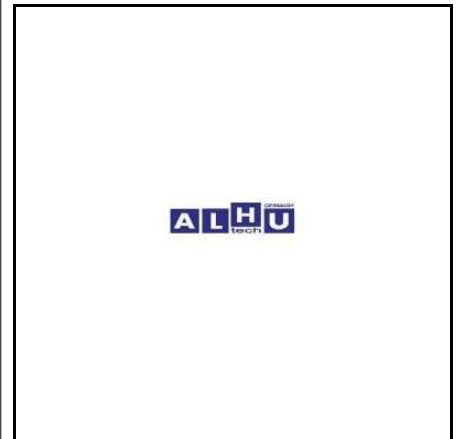

Bremse / Brake

24 051 164 CLUTCH BOOSTER

Mercedes Benz
000 295 13 18

Wabco
970.051.164.0

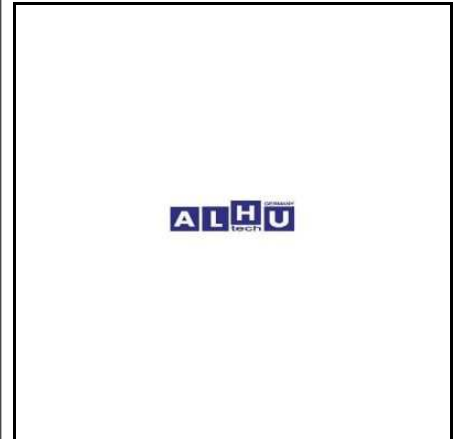

24 051 310 CLUTCH BOOSTER

Mercedes Benz
001 295 67 07

Wabco
970.051.131.0



24 051 431 CLUTCH BOOSTER

Mercedes Benz
000 254 00 47

KNORR
9700514317

TA501
625375AM
970 051 431 0



24 051 510 CLUTCH BOOSTER

Mercedes Benz
000 295 08 18

Wabco
970.051.151.0

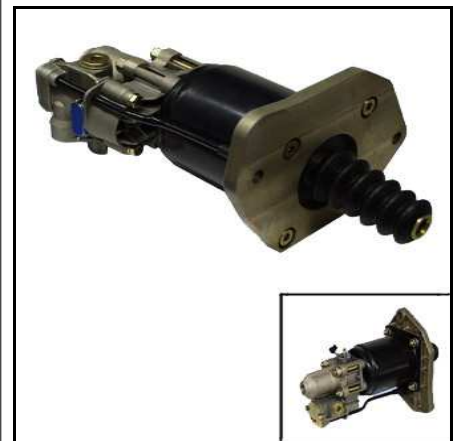

Bremse / Brake

24 051 903 CLUTCH BOOSTER KIT

Mercedes Benz
000 290 32 67



24 051 906 CLUTCH BOOSTER KIT

Mercedes Benz
000 295 06 60

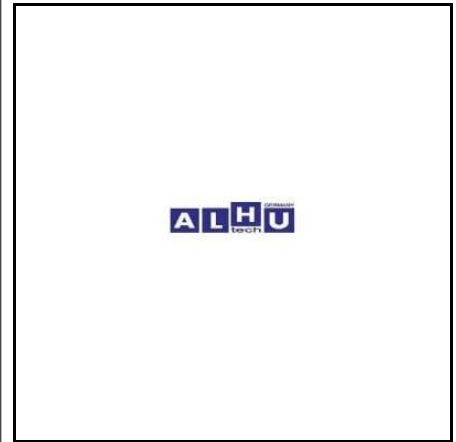

24 051 916 CLUTCH BOOSTER KIT

Mercedes Benz
000 290 03 47

Wabco
970.051.916.2



24 051 917 CLUTCH BOOSTER KIT

Mercedes Benz
000 250 03 62

Wabco
970.051.917.2

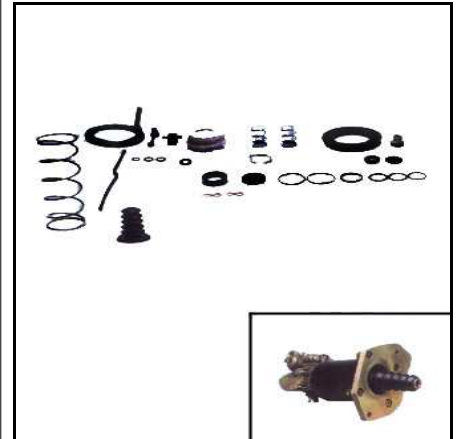

Bremse / Brake

63 450 774 CONNECTING CABLE

Mercedes Benz
380 540 21 81

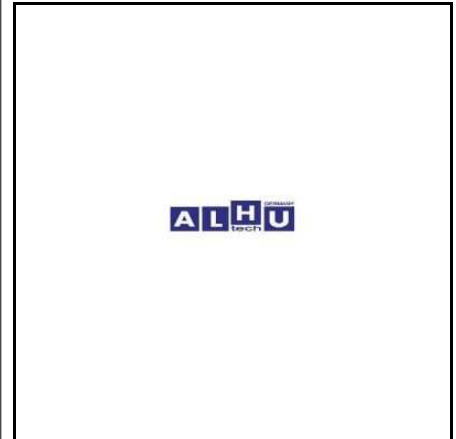

63 450 775 CONNECTING CABLE

Mercedes Benz
380 540 22 81

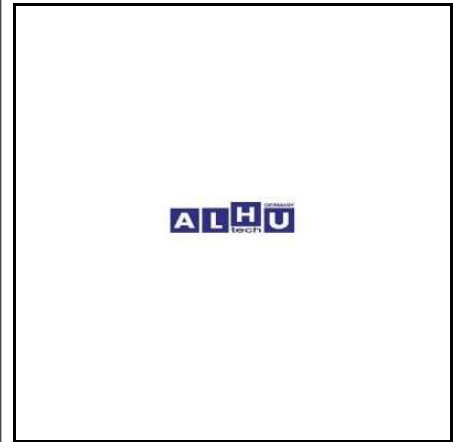

63 450 816 CONTAINER VALVE

Mercedes Benz
000 329 08 25

KNORR
183153

HALDEX
338021001

MAN
81.43610.6134

weitere/another

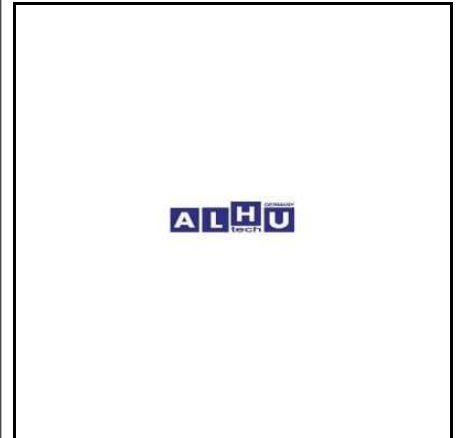

24 013 200 DIRECTIONAL CONTROL VALVE

Mercedes Benz
000 434 38 01

Wabco
463.013.200.0



Bremse / Brake

24 300 001 DRAIN VALVE WITH RING	
Mercedes Benz 000 432 08 07 000 432 21 07	KNORR I94095
DAF 505294	MAN 81.51260.6040 81.51260.6057 81.51260.6059
weitere/another	



23 201 444 DUST COVER	
Mercedes Benz 659 420 14 44 659 420 15 44	



24 420 644 DUST COVER	
Mercedes Benz 659 420 16 44 659 420 17 44	

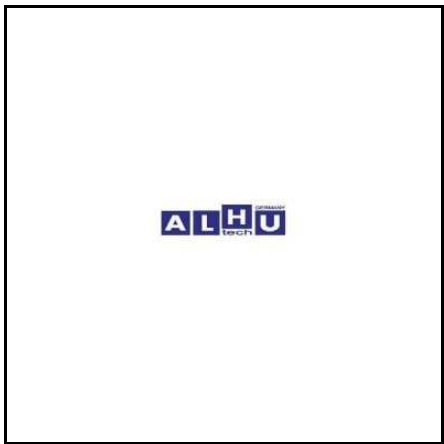

23 752 121 ECAS HEIGHT SENSOR	
Mercedes Benz 003 542 26 18	
Wabco 441.032.809.0	

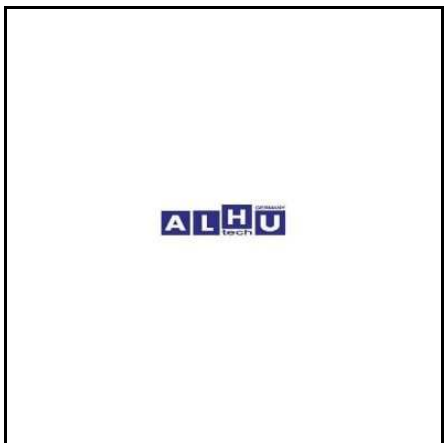

Bremse / Brake

63 450 796 ECAS HEIGHT SENSOR

Mercedes Benz
002 542 67 18

Wabco
441.050.120.0

MAN
81.25937.0040

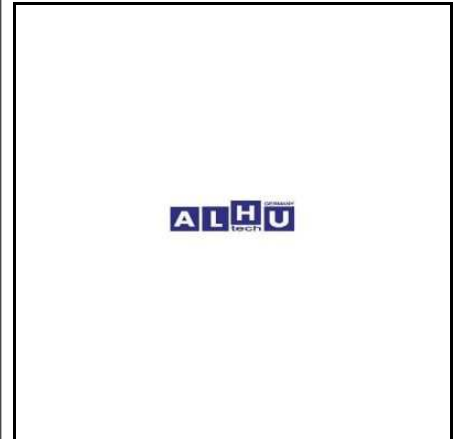

22 000 066 ECAS SOLENOID VALVE

Mercedes Benz
000 327 63 25

Wabco
472.900.021.0

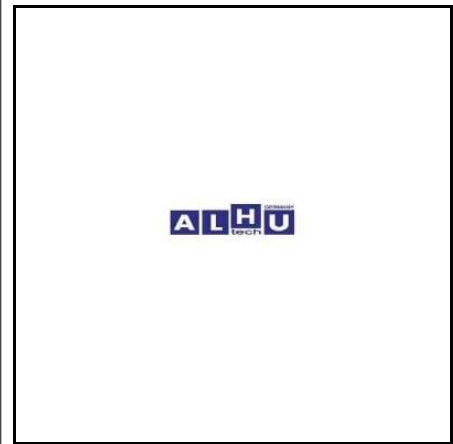

21 140 459 ENGINE BRAKE CYLINDER

Mercedes Benz
000 140 03 59
000 140 08 59

KNORR
1132920



24 013 114 ENGINE STOP VALVE

Mercedes Benz
000 434 24 01

Wabco
463.013.114.0



Bremse / Brake

24 013 116 ENGINE STOP VALVE

Mercedes Benz
000 434 21 01

MAN
81.52185.6018

KNORR
175794

Neoplan
110208

weitere/another



24 315 080 FOOT BRAKE VALVE

Mercedes Benz
001 431 83 05
001 431 89 05
002 431 81 05

Wabco
461.315.008.0

Scania
354611



24 319 080 FOOT BRAKE VALVE

Mercedes Benz
002 431 06 05

Wabco
461.319.008.0

KNORR
0481064201000



63 450 569 HAND BRAKE VALVE



Mercedes Benz
003 430 73 81
003 430 74 81

Wabco
961.723.125.0

KNORR
DPM 22 A

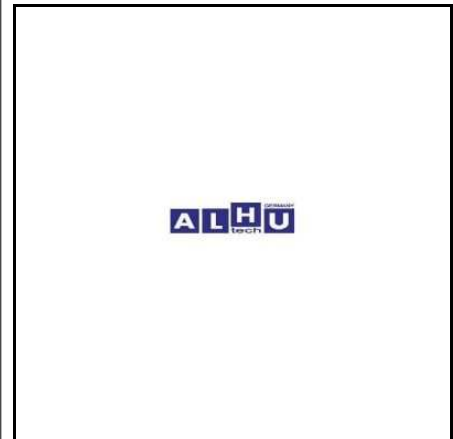

Bremse / Brake

63 451 094 HAND BRAKE VALVE

Mercedes Benz
001 430 32 81

Wabco
961.722.264.0

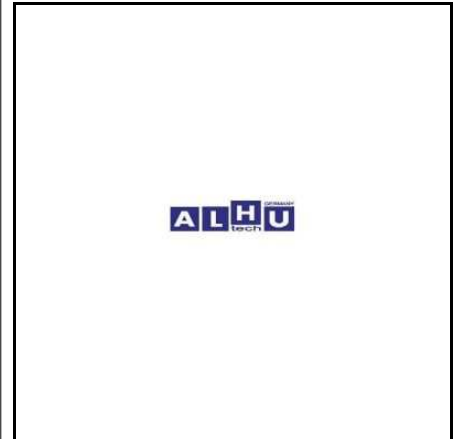

22 722 004 HAND BRAKE VALVE REPAIR KIT

Mercedes Benz
003 430 33 81

Wabco
961.722.004.2

MAN
81.52315.6106

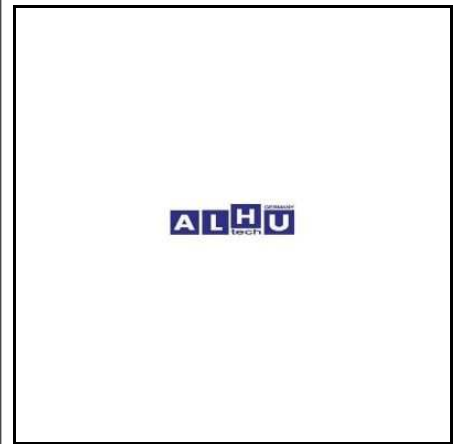

21 153 928 KNOCK SENSOR

W124 W140 W168

Mercedes Benz
003 153 89 28

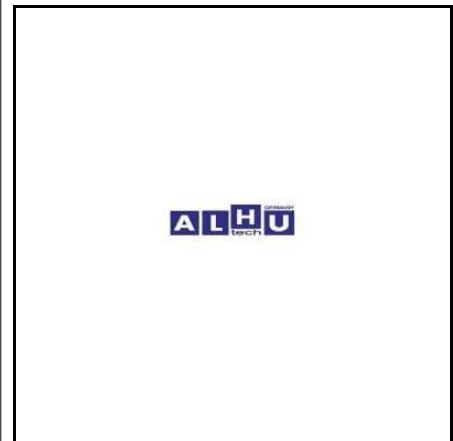

24 500 020 LINE FILTER, COMPRESSOR SYSTEM

Mercedes Benz
000 429 29 95

MAN
81.51270.6026

HALDEX
310005011

Wabco
432.500.020.0



Bremse / Brake

23 994 001 LOCK

Mercedes Benz
000 994 25 45



23 500 600 NON-RETURN VALVE

Mercedes Benz
000 327 21 25

KNORR
0500100006000



22 015 004 PRESSURE LIMITER VALVE

Mercedes Benz 001 431 63 06	Wabco 475.015.004.0
MAN 81.52101.6153	



24 303 473 PRESSURE REGULATOR

Mercedes Benz 001 431 00 06 002 431 43 06	KHD 2516923
Iveco 4842611	KNORR 0481039201000

weitere/another



Bremse / Brake

24 303 474 PRESSURE REGULATOR

Mercedes Benz
003 431 36 06

MAN
84.52101.6017

Bosch
0 481 039 209

Wabco
975.303.474.0



22 116 075 RELAY VALVE

Mercedes Benz
004 429 63 44

Wabco
973.006.003.0

MAN
81.52116.6075

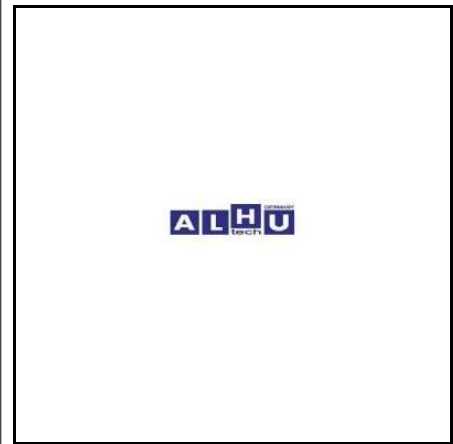

24 001 100 RELAY VALVE

Mercedes Benz
000 429 65 44

KNORR
I76792

KHD
42030573

MAN
81.43609.6008

weitere/another



24 001 200 RELAY VALVE

Mercedes Benz
001 429 68 44
002 429 92 44

MAN
81.52116.6022

Bosch
0 481 026 005

Neoplan
110205

weitere/another



Bremse / Brake

63 450 152 RELAY VALVE	
Mercedes Benz 004 429 38 44	MAN 81.52116.6070
KNORR K008490	Wabco 973.011.001.0



63 450 267 REPAIR KIT SPRING	
Mercedes Benz 007 993 56 01	



22 420 944 REPAIR KIT, BRAKE CALIPER	
	TGA TGS TGX
Mercedes Benz 000 420 06 82 000 420 39 82	MAN 81.50822.6032
KNORR K000944	



24 300 000 REPAIR KIT, UNLOADER VALVE	
Mercedes Benz 000 430 11 07	Wabco 975.300.000.2
MAN 81.52101.6118	



Bremse / Brake

63 451 675 REP. KIT BRAKE SHOE PIN



Mercedes Benz
307 420 41 02

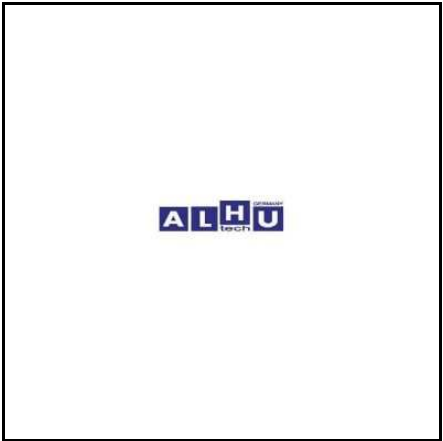

22 010 002 REP. KIT BRAKE CAMSHAFT

Mercedes Benz
360 420 03 41

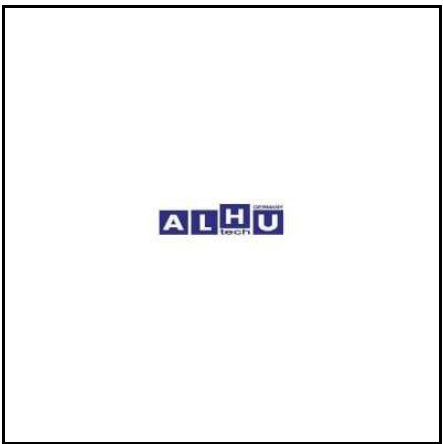

22 010 003 REP. KIT BRAKE CAMSHAFT

Mercedes Benz
360 420 04 41

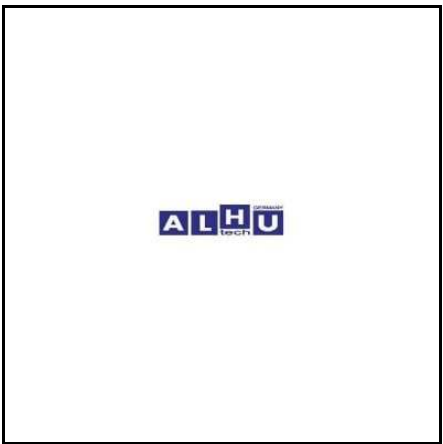

63 450 755 SENSOR

Mercedes Benz
000 542 91 18

Wabco
441.100.072.0

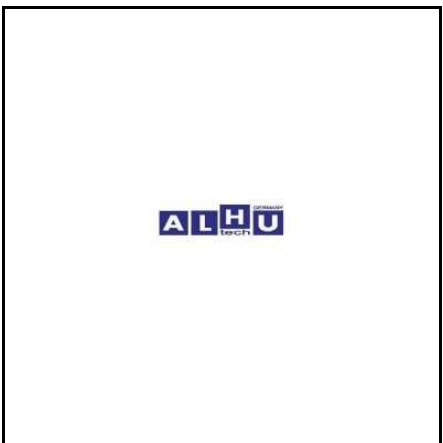

Bremse / Brake

24 002 107 SHUT-OFF VALVE

Mercedes Benz
000 429 16 31

MAN
81.51230.6009

KNORR
I28323

Wabco
452.002.107.0



24 407 060 SILENCER

Mercedes Benz
000 430 23 70

Wabco
432.407.060.0

MAN
81.52101.6274

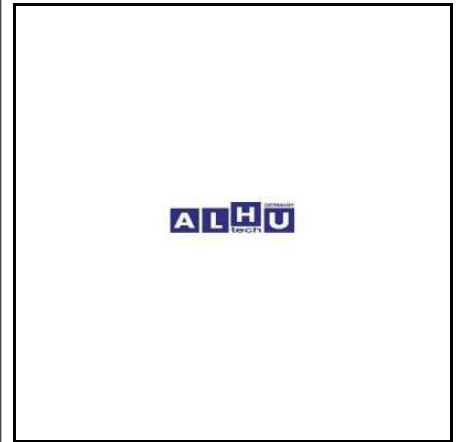

24 407 071 SILENCER

Mercedes Benz
000 430 20 70

Wabco
432.407.012.0

MAN
81.52101.6264



24 420 238 SLACK ADJUSTER

Mercedes Benz
945 420 03 38

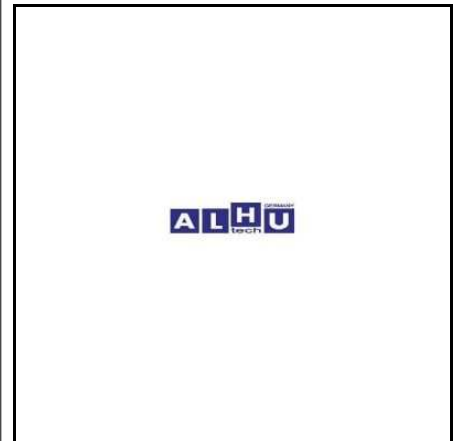

Bremse / Brake

24 420 338 SLACK ADJUSTER

Mercedes Benz
945 420 02 38



24 420 438 SLACK ADJUSTER

Mercedes Benz
945 420 04 38



24 420 938 SLACK ADJUSTER

Mercedes Benz
945 420 09 38



63 450 549 SLACK ADJUSTER

MERCEDES

Mercedes Benz
357 420 05 38



Bremse / Brake

63 450 550 SLACK ADJUSTER

MERCEDES

Mercedes Benz
357 420 06 38



63 450 551 SLACK ADJUSTER

MERCEDES

Mercedes Benz
357 420 07 38



24 420 092 SLACK ADJUSTER KIT

Mercedes Benz 000 420 00 92	RENAULT-TRUCKS 5001825536
MAN 81.50610.6132	Scania 324728 324729 1350817

weitere/another



63 450 580 SOLENOID VALVE

Mercedes Benz
004 429 60 44

KNORR
1115687

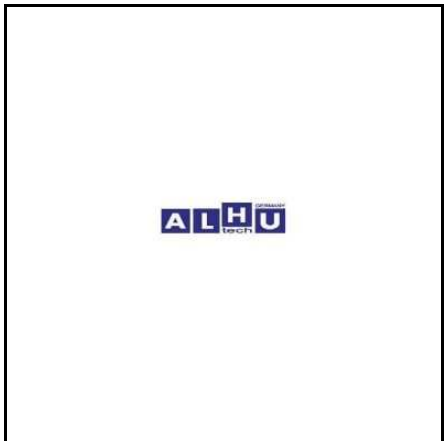

Bremse / Brake

63 450 824 SPRING RETAINING PIN

Mercedes Benz

387 421 00 74
658 421 00 74

MAN

81.50211.0027

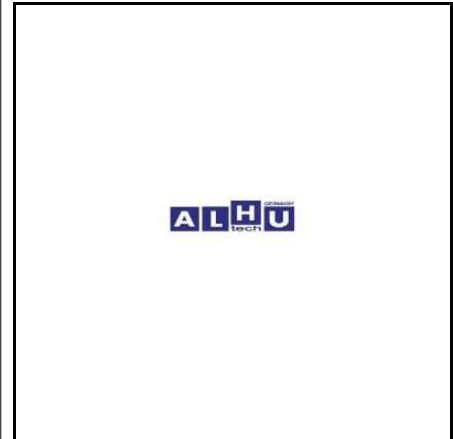

24 002 200 TRAILER CONTROL VALVE

Mercedes Benz

002 431 48 05

Wabco

973.002.520.0



24 002 210 TRAILER CONTROL VALVE

Mercedes Benz

002 431 01 05

KNORR

0481061219000

MAN

81.52301.6165

Wabco

973.002.521.0



63 450 930 TRAILER CONTROL VALVE



Mercedes Benz

002 431 28 05

Bosch

0481061005000

DAF

1506636

Iveco

2516806
4682684

weitere/another

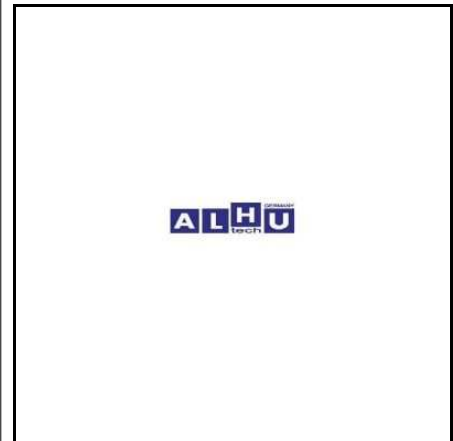

Bremse / Brake

22 400 001 4-CIRCUIT PROTECTION VALVE

Mercedes Benz

001 431 47 06
002 431 04 06

Wabco

934.702.210.0

KNORR

173329



22 400 007 4-CIRCUIT PROTECTION VALVE

Mercedes Benz

002 431 13 06

KNORR

170615

KHD

42051732



61 451 655 4-CIRCUIT PROTECTION VALVE



Mercedes Benz

001 431 59 06

KNORR

175300



Diverse / Diverse

8.8M12X1.5X30 CHEESE HEAD SCREW DIN 912

Mercedes Benz
000 912 01 20 47

MAN
06.02099.0204

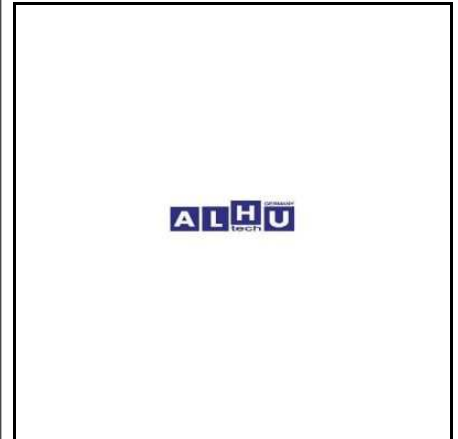

AM 16X1.5 HEX LOCK NUT

Mercedes Benz
913 004 01 60 05

MAN
06.11241.0317

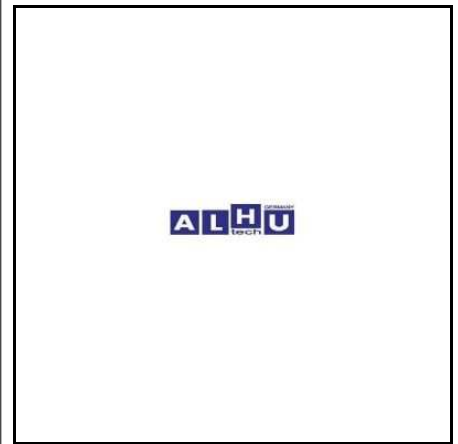

10.9M16X1.5X5 HEX. HEAD SCREW DIN 961



Mercedes Benz
000 960 01 62 49

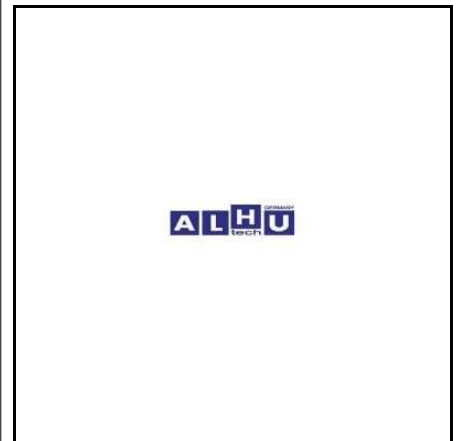

8.8M16X1.5X50 HEX. HEAD SCREW DIN 961



Mercedes Benz
000 961 01 60 39

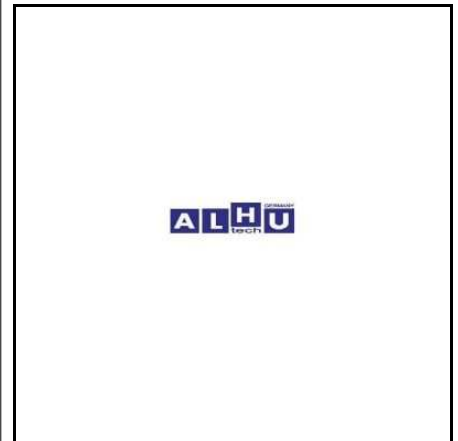

Diverse / Diverse

8.8 M10 X 45 SCREW DIN 931 8.8
ZINCPLATED

Mercedes Benz
000 931 01 02 64



8.8 M10 X 80 SCREW ZINCPLATED DIN 931

Mercedes Benz
000 931 01 02 39



63 451 146 STUD 8.8

Mercedes Benz
000 939 01 00 09



M12 X 35 STUD 8.8 DIN 939



Mercedes Benz
000 939 01 20 41



Elektrik / Electric

21 033 019 ALTERNATOR
 28 Volt - 80 Ampere
 ACTROS

Mercedes Benz
 010 154 91 02

Bosch
 6 033 GB3 019

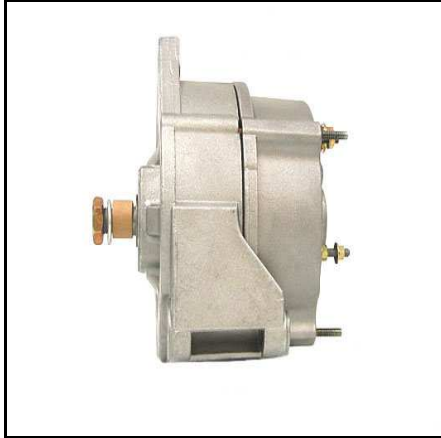

21 033 023 ALTERNATOR
 28 Volt - 100 Ampere

Mercedes Benz
 010 154 92 02

Bosch
 0 986 041 030
 6 033 GB3 023



21 219 007 ALTERNATOR

Mercedes Benz
 004 151 02 01
 004 151 32 01

Bosch
 0 001 219 007

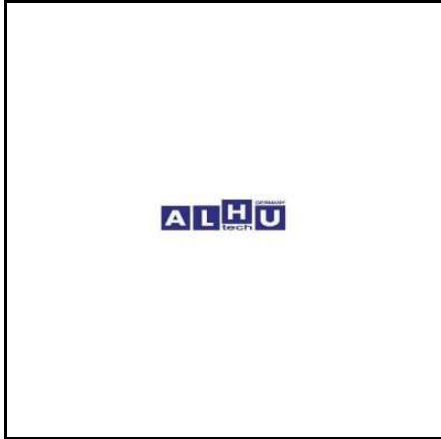

21 335 002 ALTERNATOR

Mercedes Benz
 009 154 02 02

Bosch
 0 123 335 002

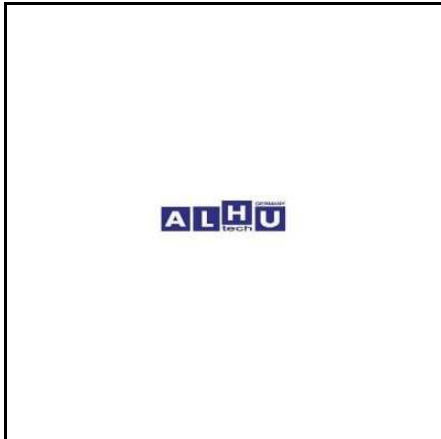

Elektrik / Electric

21 468 053 ALTERNATOR
28 V

Mercedes Benz
007 154 92 02

MAN
51.26101.7192

Bosch
0 120 468 053
0 120 468 107



21 469 115 ALTERNATOR

Mercedes Benz
009 154 98 02

Bosch
0 120 469 115

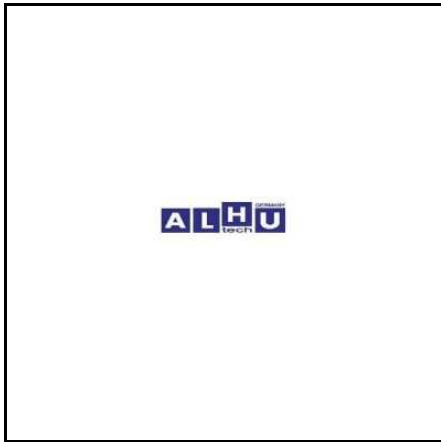

21 469 744 ALTERNATOR

Mercedes Benz
007 154 68 02

Bosch
0 120 469 744

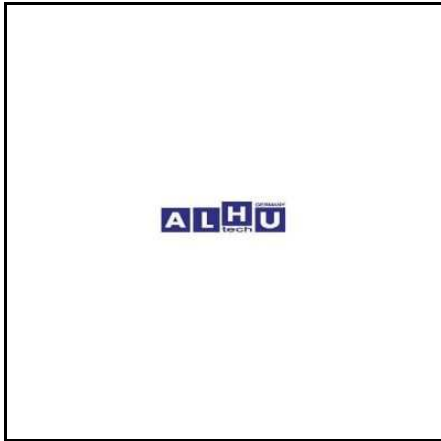

21 469 796 ALTERNATOR

Mercedes Benz
007 154 81 02

Bosch
0 120 469 796

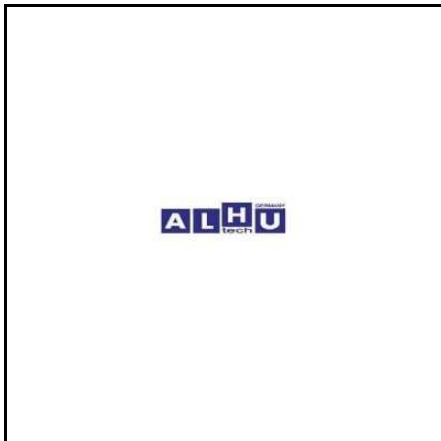

Elektrik / Electric

21 469 982 ALTERNATOR
10/55 A

Mercedes Benz
009 154 07 02

MAN
51.26101.7201

Bosch
0 120 469 982



21 489 325 ALTERNATOR

Mercedes Benz
007 154 54 02

Bosch
0 120 489 325

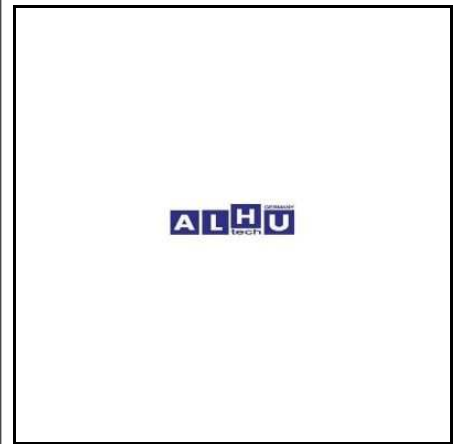

21 489 728 ALTERNATOR
27 A

Mercedes Benz
007 154 90 02

MAN
51.26101.7148

Bosch
0 120 489 728

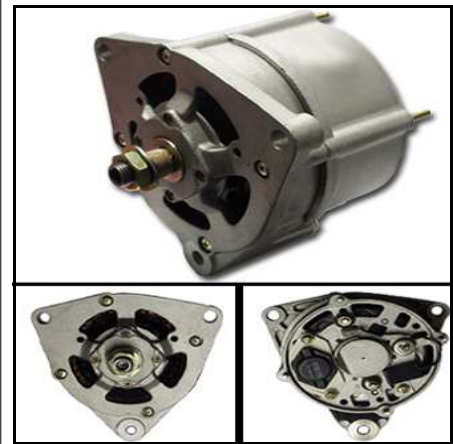

21 555 001 ALTERNATOR
8-groove pulley, 28V 35/80A

ACTROS

Mercedes Benz
011 154 86 02
013 154 28 02

Bosch
0 124 555 001

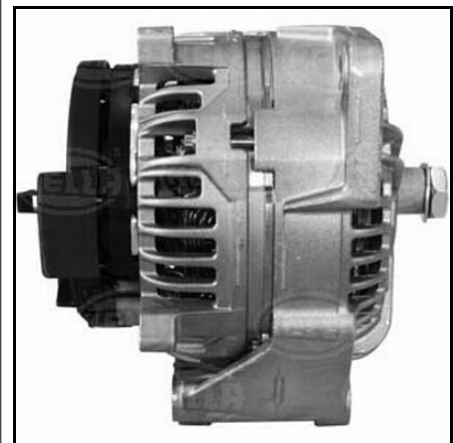

Elektrik / Electric

21 555 002 ALTERNATOR

9-groove pulley

Mercedes Benz

012 154 10 02

Bosch

0 124 555 002

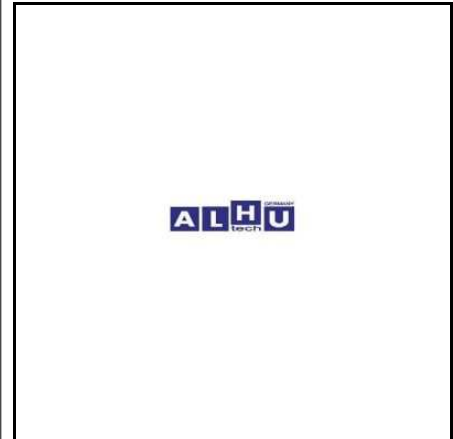

21 555 004 ALTERNATOR

11-groove pulley

Mercedes Benz

013 154 29 02

Bosch

0 124 555 004

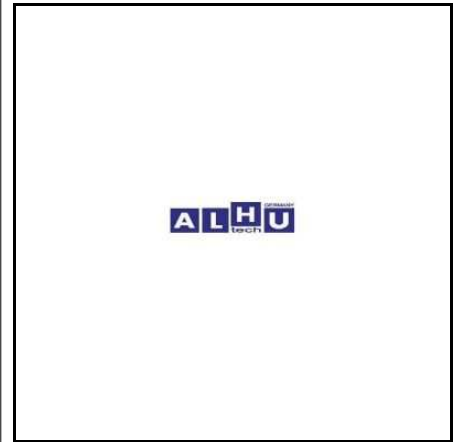

21 555 032 ALTERNATOR

without pulley

Mercedes Benz

013 154 78 02

Bosch

0 124 555 022

0 124 555 032

0 986 048 100

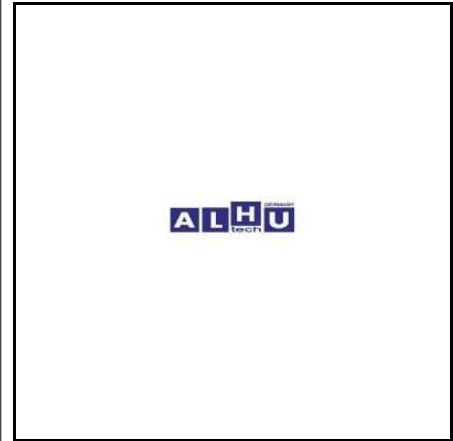

21 689 535 ALTERNATOR

28V 70/140A

Mercedes Benz

008 154 78 02

Bosch

0 120 689 535

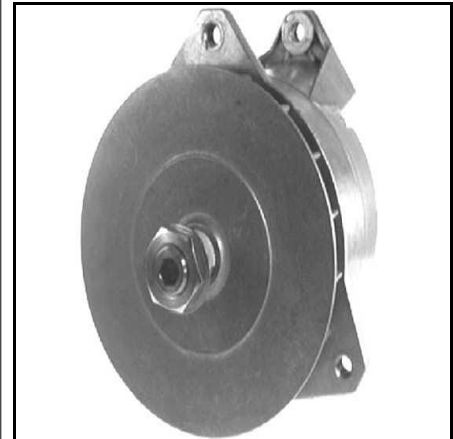

Elektrik / Electric

21 689 541 ALTERNATOR

70/140 AMPERE

Mercedes Benz

011 154 96 02

MAN

81.26101.6084

Bosch

0 120 689 569

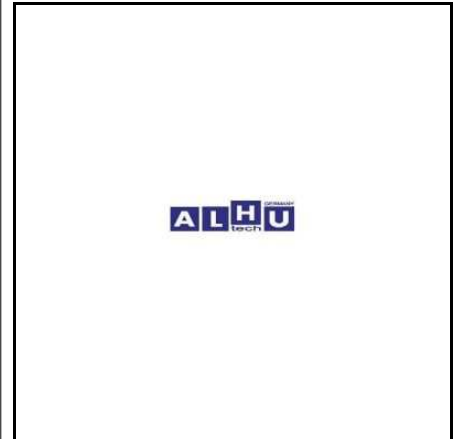

21 004 003 ARMATURE

Mercedes Benz

000 151 51 15

Bosch

2 004 004 003

2 004 014 960



21 004 033 ARMATURE

Mercedes Benz

000 151 48 15

Monark

084 059 033

Bosch

2 004 004 033



21 005 022 ARMATURE

KB24 Volt-5,4 KW

Mercedes Benz

000 151 40 15

DAF

697876

Bosch

2 004 005 037

2 004 005 153

MAN

81.26203.6018



Elektrik / Electric

21 005 025 ARMATURE

Mercedes Benz
000 151 39 15

MAN
81.26203.6007

Bosch
2 004 005 025



21 014 052 CARBON BRUSH SET

Mercedes Benz
000 151 54 14

MAN
A5.00024.0938

Bosch
2 007 014 052

Scania
292896

weitere/another



21 014 062 CARBON BRUSH SET

Mercedes Benz
000 151 80 14

KHD
1308816

Bosch
2 007 014 062

Scania
280899

weitere/another



21 014 063 CARBON BRUSH SET

Mercedes Benz
000 151 79 14

Volvo
6210778

Bosch
2 007 014 063



Elektrik / Electric

21 014 070 CARBON BRUSH SET

Mercedes Benz
000 151 89 14

MAN
81.25921.6051

Bosch
2 007 014 061
2 007 014 070

Scania
313201

weitere/another

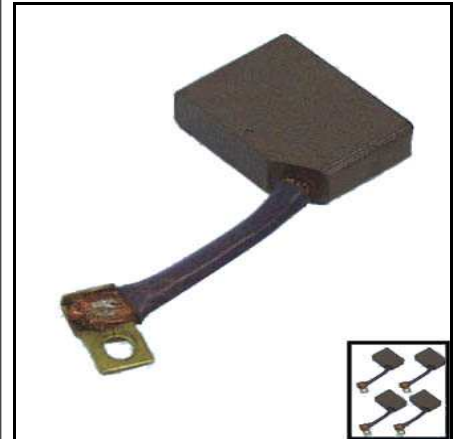

21 014 079 CARBON BRUSH SET

Mercedes Benz
001 151 32 14

MAN
81.25921.6058

Bosch
2 007 014 079

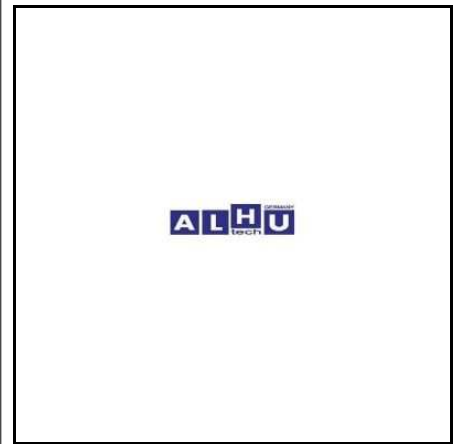

21 004 036 FIELD COIL

Bosch
2 004 125 036

RENAULT-TRUCKS
7701008182

MAN
81.26204.0013

Scania
220365

weitere/another

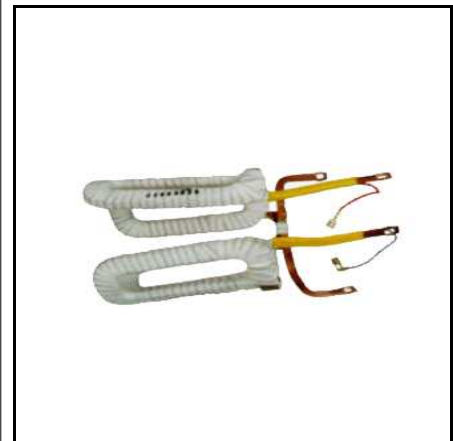

21 004 078 FIELD COIL

Mercedes Benz
000 151 70 55

MAN
81.26204.0032

Bosch
2 004 125 078

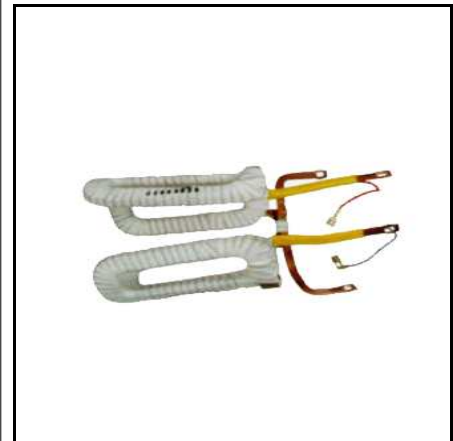

Elektrik / Electric

21 004 083 FIELD COIL

Mercedes Benz 000 151 80 55	Iveco 8198726
Bosch 2 004 125 083	MAN 81.26204.0033

weitere/another

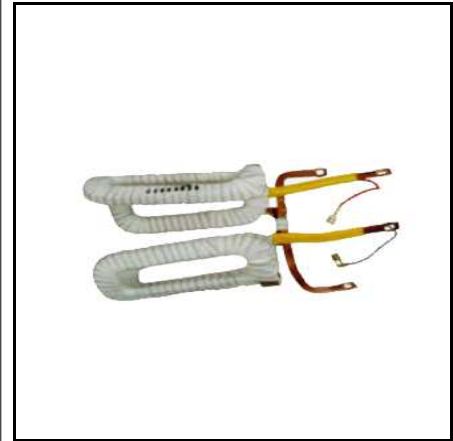

21 114 060 FIELD COIL

Mercedes Benz 000 151 56 55	Monark 084 169 060
Bosch 2 004 114 060	



21 114 065 FIELD COIL

Mercedes Benz 000 151 55 55	Monark 084 169 065
Bosch 2 004 114 065	



25 545 401 FUSE BOX

Mercedes Benz
000 545 84 01

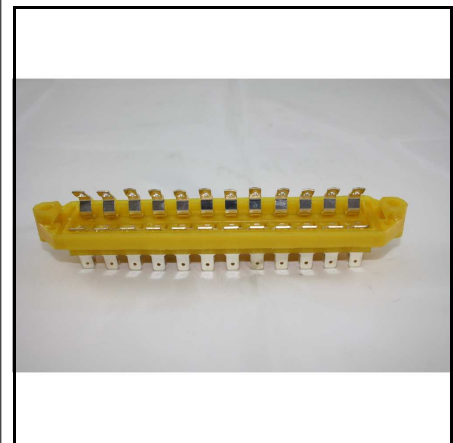

Elektrik / Electric

25 545 501 FUSE BOX

Mercedes Benz
000 545 85 01



25 542 120 HORN 24V, 335 HZ

Mercedes Benz 002 542 67 20	KHD 42047451
Bosch 0 986 320 301	MAN 81.25301.6066



25 215 002 INDICATOR RELAY

Mercedes Benz 002 544 79 32	MAN 88.25310.6002
Bosch 0 335 215 154	Volvo 1582410



25 215 150 INDICATOR RELAY

Mercedes Benz
003 544 50 32



Elektrik / Electric

25 215 250 INDICATOR RELAY

Mercedes Benz 003 544 06 32	HELLA 4DZ002834-161
Bosch 0 335 215 241 0 335 215 250	



25 215 550 INDICATOR RELAY

Mercedes Benz 002 544 80 32	MAN 81.25310.0034
Bosch 0 335 215 143	Volvo 1501686 1587993



25 543 015 MODUL

Mercedes Benz
000 543 10 15

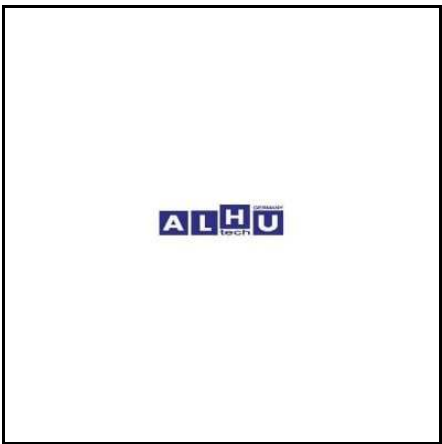

25 543 115 MODUL

Mercedes Benz
000 543 89 15

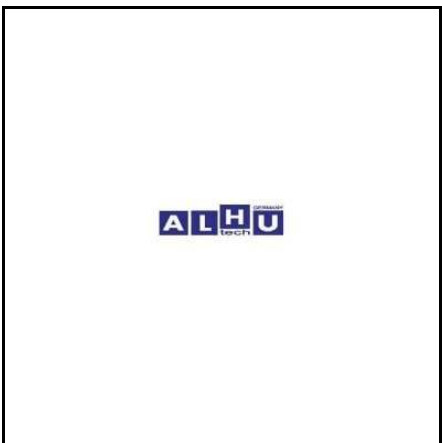

Elektrik / Electric

25 543 215 MODUL

Mercedes Benz
000 543 90 15



21 910 005 NEEDLE BEARING

Mercedes Benz
006 981 89 10

Volvo
240453

Bosch
2 000 910 005



63 451 653 RECTIFIER

Mercedes Benz
001 154 12 16

MAN
81.26109.0014

Bosch
1 127 320 961



21 127 095 RECTIFIER ASSY

Mercedes Benz
000 154 57 16

MAN
81.26109.0004

Bosch
1 127 011 095

Volvo
244343



Elektrik / Electric

21 127 097 RECTIFIER ASSY

Mercedes Benz
000 154 58 16

DAF
694065

Bosch
1 127 011 098

KHD
1309115



63 453 042 RECTIFIER ASSY



Mercedes Benz
001 154 21 16

MAN
81.26109.0018

Bosch
1 127 320 989

Volvo
3090260
3090262



25 542 016 RPM METER

Mercedes Benz
001 542 40 16



25 542 716 RPM METER

Mercedes Benz
001 542 87 16

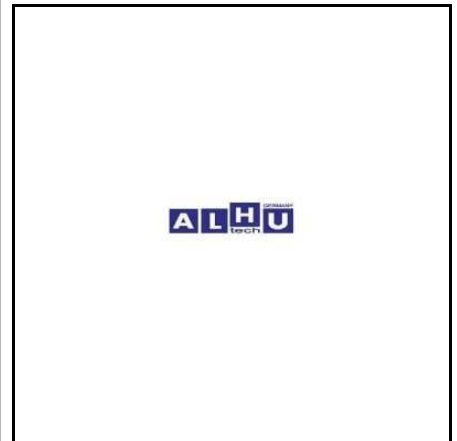

Elektrik / Electric

21 101 003 SOLENOID SWITCH

Bosch
0 331 101 003

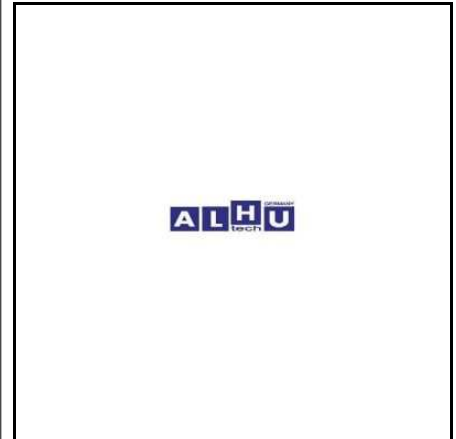

21 101 006 SOLENOID SWITCH

Mercedes Benz
000 152 40 10

DAF
252120

Bosch
0 331 101 006

Iveco
79052269

weitere/another



21 101 011 SOLENOID SWITCH
STARTER, 12 V

Bosch
0 331 101 011

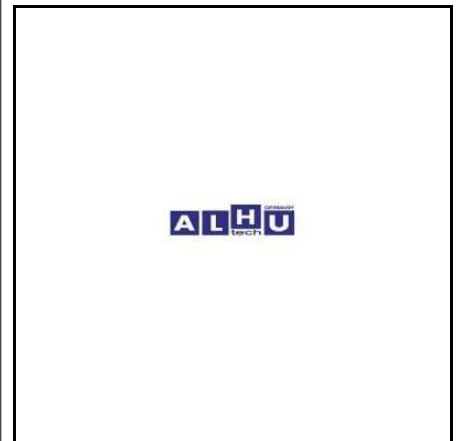

21 337 726 SOLENOID SWITCH

ACTROS

Mercedes Benz
001 152 24 10

Bosch
1 337 210 726

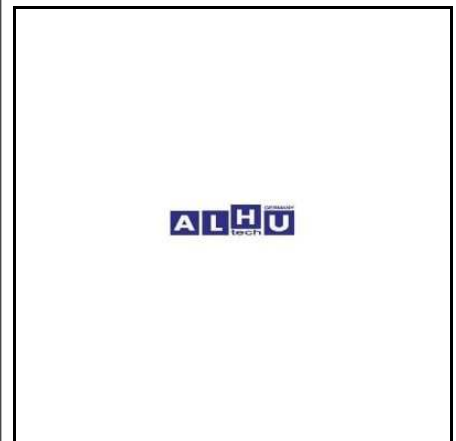

Elektrik / Electric

21 339 010 SOLENOID SWITCH

ACTROS

Mercedes Benz
001 152 32 10

Bosch
2 339 403 010



21 402 001 SOLENOID SWITCH

Mercedes Benz
000 152 30 10

Bosch
0 331 402 001



21 402 010 SOLENOID SWITCH

Mercedes Benz
000 152 34 10

Bosch
0 331 402 010



21 450 001 SOLENOID SWITCH

Mercedes Benz 000 152 42 10 000 152 89 10	DAF 252121
Bosch 0 331 450 001	Iveco 79052266

weitere/another

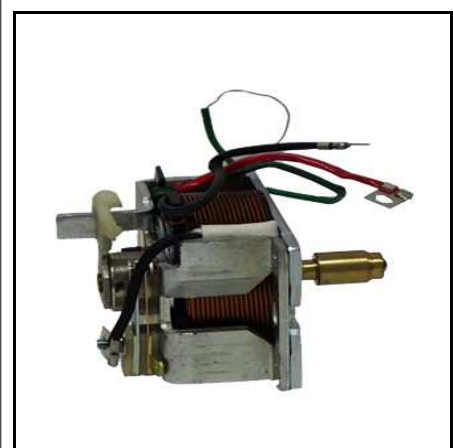

Elektrik / Electric

63 453 026 SOLENOID SWITCH



Mercedes Benz
001 152 36 10

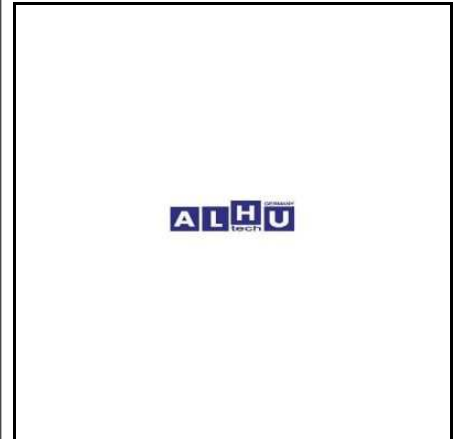

25 542 206 SPEEDOMETER

125 KM/H, black

Mercedes Benz
008 542 22 06

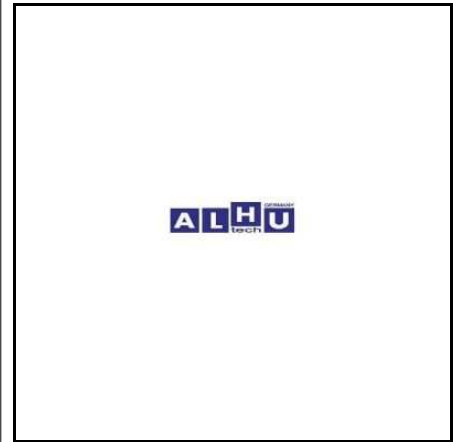

21 005 498 STARTER ARMATURE

Mercedes Benz
343 151 70 15

Volvo
11991953

Bosch
9 001 083 498

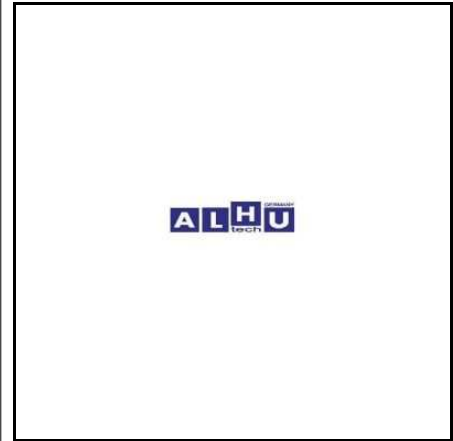

21 301 043 STARTER BUSHING

18x14x13,8 mm

Mercedes Benz
000 151 35 50

KHD
1308147

Bosch
2 000 301 043

Scania
313263



Elektrik / Electric

21 401 527 STARTER CLUTCH

Mercedes Benz
000 151 06 33

DAF
244606

Bosch
2 006 401 527

MAN
81.26225.6003

weitere/another



29 542 819 STARTER INTERLOCK

Mercedes Benz
001 542 48 19

MAN
81.25902.0203

Bosch
0 331 801 300

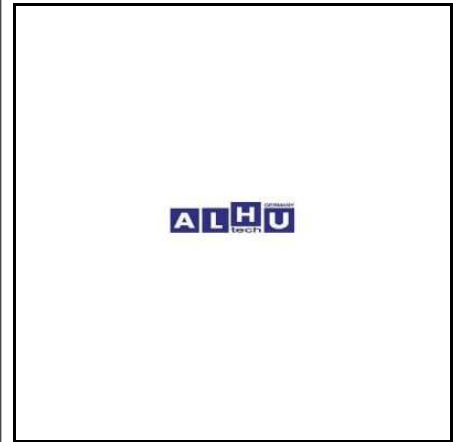

21 231 002 STARTER MOTOR

EV 24V - 4,0KW

Mercedes Benz
005 151 20 01

Bosch
0 001 231 002
0 001 231 033
0 986 017 240



21 231 003 STARTER MOTOR

EV 24 V-4,0 KW

Mercedes Benz
004 151 86 01

Bosch
0 001 231 003



Elektrik / Electric

21 367 034 STARTER MOTOR
 12 V - 3,0 KW

Mercedes Benz
 004 151 58 01

Bosch
 0 001 367 034



21 368 024 STARTER MOTOR
 24 V - 4,0 KW

Mercedes Benz
 004 151 59 01

Bosch
 0 001 368 309



21 372 001 STARTER MOTOR

Mercedes Benz
 004 151 94 01

Bosch
 0 001 372 001



21 372 005 STARTER MOTOR
 IE 24V-6,2KW

Mercedes Benz
 457 151 03 01

Bosch
 0 001 372 005



Elektrik / Electric

21 372 006 STARTER MOTOR	
IE 24V - 6,2 KW	
ACTROS	
Mercedes Benz	
005 151 50 01	
005 151 64 01	
005 151 70 01	
Bosch	
0 001 372 006	



21 416 022 STARTER MOTOR	
Mercedes Benz	
003 151 95 01	
MAN	
51.26201.7112	
Bosch	
0 001 416 022	



21 416 024 STARTER MOTOR	
Mercedes Benz	
003 151 60 01	
MAN	
51.26201.7074	
Bosch	
0 001 416 024	



21 416 040 STARTER MOTOR	
24 V - 5,4 KW	
Mercedes Benz	
003 151 67 01	
Bosch	
0 001 416 040	



Elektrik / Electric

21 416 047 STARTER MOTOR

Mercedes Benz

002 151 81 01
003 151 57 01

Bosch

0 001 416 047



21 417 001 STARTER MOTOR

24 V - 6,6 KW

Mercedes Benz

004 151 61 01
005 151 28 01

MAN

51.26201.7123

Bosch

0 001 411 009
0 001 417 001



21 417 036 STARTER MOTOR

24 V- 6,6 KW

Mercedes Benz

003 151 66 01

Bosch

0 001 417 036



21 418 012 STARTER MOTOR

12 V 3,6 KW

Mercedes Benz

003 151 56 01

Bosch

0 001 418 012

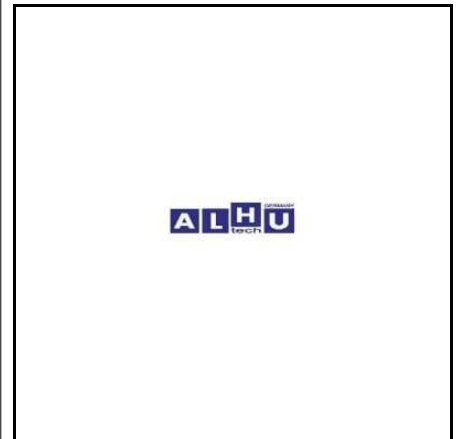

Elektrik / Electric

21 431 002 STARTER MOTOR

24V - 5,4 KW

Mercedes Benz
004 151 60 01

MAN
51.26201.7159

Bosch
0 001 416 002
0 001 416 078
0 986 011 570



21 006 020 STARTER PINION

Mercedes Benz
001 151 05 13

MAN
81.26209.0015

Bosch
2 006 382 176



21 209 422 STARTER PINION

Mercedes Benz
000 151 66 13

MAN
81.26209.0016

Bosch
2 006 209 422



21 209 492 STARTER PINION

Mercedes Benz
000 151 88 13

KHD
1308752

Bosch
2 006 209 492



Elektrik / Electric

21 010 000 STARTER REP KIT

Bosch
1 987 010 000

Monark
087 065 805



21 301 015 STARTER SHAFT BUSHING
48x40x10,3 mm

Mercedes Benz 000 151 40 50	DAF 573329
Bosch 2 000 301 015	MAN 81.93020.0427



21 301 016 STARTER SHAFT BUSHING
28x22x11,3 mm

Mercedes Benz 000 151 41 50	MAN 81.93020.0428
Bosch 2 000 301 016	



21 045 056 STATOR

Mercedes Benz
000 154 46 25

Bosch
1 125 045 056

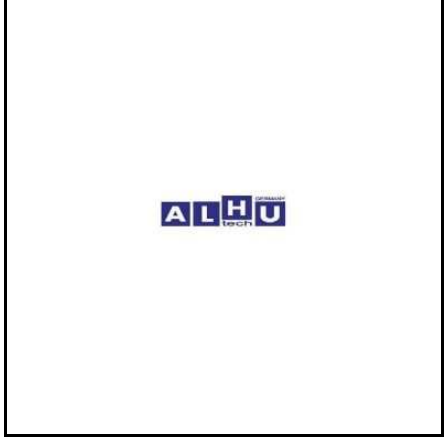

Elektrik / Electric

25 542 717 TACHOMETER

Mercedes Benz
000 542 97 16

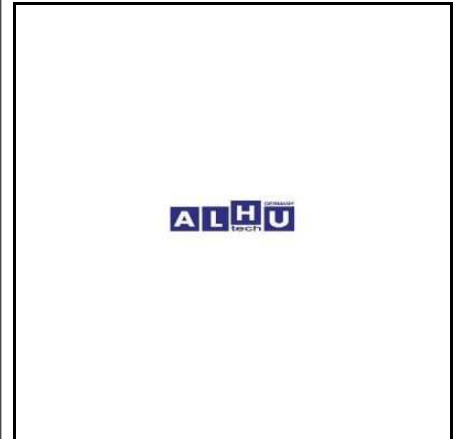

21 145 298 VOLTAGE REGULATOR

ACTROS

Mercedes Benz
000 154 26 05

Bosch
F 00M 144 107
F 00M 144 123
F 00M 145 298



21 192 004 VOLTAGE REGULATOR

28 V

Mercedes Benz
002 154 05 06

Bosch
0 192 033 004



21 192 005 VOLTAGE REGULATOR

28 V

Mercedes Benz
001 154 88 06

KHD
1162829

Bosch
0 192 033 005

MAN
81.25601.0011



Elektrik / Electric

21 192 006 VOLTAGE REGULATOR

28 VOLT

Mercedes Benz

002 154 39 06

Bosch

0 192 053 006



21 192 014 VOLTAGE REGULATOR

28 VOLT

Mercedes Benz

002 154 96 06

MAN

81.25601.6030

Bosch

0 192 053 014

1 197 311 315



21 311 301 VOLTAGE REGULATOR

28 VOLT

Mercedes Benz

000 154 17 05

002 154 17 05

002 154 84 06

MAN

81.25601.6035

Iveco

93158421

Scania

1117253

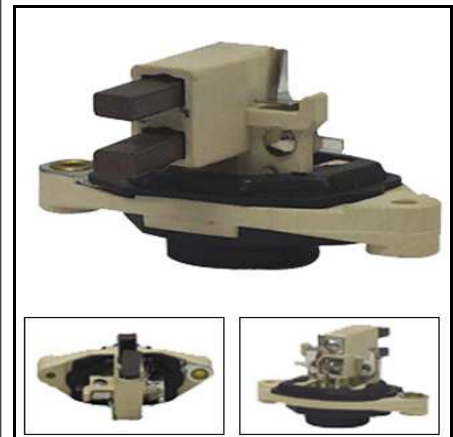

Getriebe / Gear

21 000 005 BALL JOINT

Mercedes Benz
000 996 56 45



22 268 189 BALL JOINT LEFT

Mercedes Benz 000 268 61 89	Scania 371451
MAN 81.95301.6171	ZF 0732 107 019



22 268 289 BALL JOINT RIGHT

Mercedes Benz 000 268 62 89	Scania 371452
MAN 81.95301.6170	ZF 0732 107 018



22 268 589 BALL JOINT TOP, W. NUT

Mercedes Benz 000 268 48 89 000 268 52 89	ZF 0501 203 819 0501 204 714
MAN 81.95301.6169	



Getriebe / Gear

22 996 245 BALL JOINT

Mercedes Benz
000 996 52 45



22 996 440 BALL JOINT

Mercedes Benz
000 996 64 40



22 996 545 BALL JOINT

Mercedes Benz
000 996 55 45



22 996 645 BALL JOINT

Mercedes Benz
000 996 66 45



Getriebe / Gear

22 996 845 BALL JOINT

Mercedes Benz
000 996 68 45

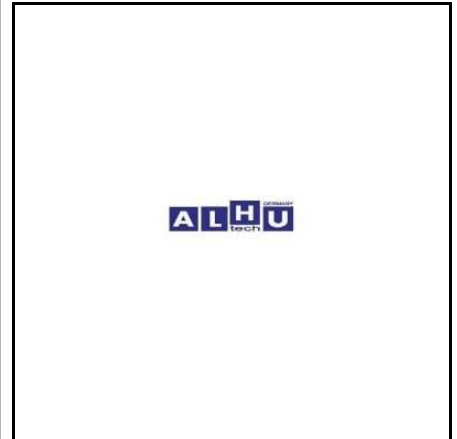

22 258 089 BALL SOCKET, GEARSHIFT LINKAGE

Mercedes Benz
356 268 00 89



22 268 889 BALL SOCKET, GEARSHIFT LINKAGE

Mercedes Benz
000 268 59 89



22 268 989 BALL SOCKET, GEARSHIFT LINKAGE

Mercedes Benz
000 268 69 89



Getriebe / Gear

63 450 112 BUSH	
Mercedes Benz 000 268 21 50	ZF 0730 260 330
MAN 81.93020.0525	



22 268 035 BUSHING	
Mercedes Benz 310 268 00 35	



22 268 050 BUSHING	
Mercedes Benz 352 268 00 50	



22 268 243 BUSHING	
Mercedes Benz 314 268 02 43	



Getriebe / Gear

22 268 250 BUSHING

Mercedes Benz
314 268 02 50



22 268 335 BUSHING

Mercedes Benz
352 268 03 35

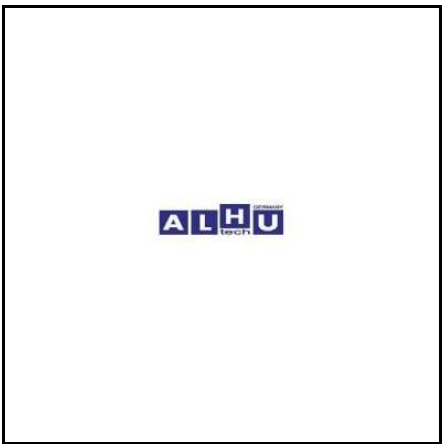

22 268 450 BUSHING

Mercedes Benz
352 268 04 50

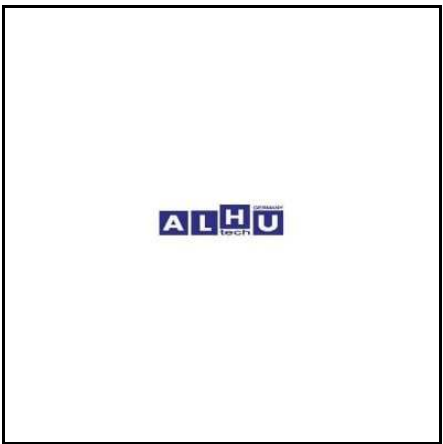

24 051 441 CLUTCH BOOSTER

Mercedes Benz 000 254 04 47	Wabco 970.051.441.0
MAN 81.30725.6104	

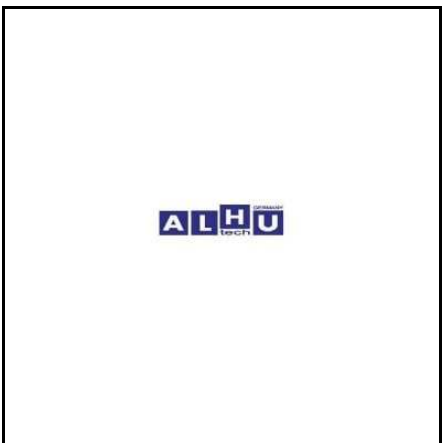

Getriebe / Gear

63 450 810 CLUTCH BOOSTER



Mercedes Benz
001 295 47 06

Wabco
470.051.114.0

MAN
81.32735.6047



25 000 004 CLUTCH HOSE

Mercedes Benz
655 290 30 13

MAN
81.32655.6250



25 000 005 CLUTCH HOSE

Mercedes Benz
655 290 44 13



63 450 822 CLUTCH HOSE

Mercedes Benz
335 573 00 36



Getriebe / Gear

63 450 988 CLUTCH HOSE

Mercedes Benz
000 295 17 35



63 450 989 CLUTCH HOSE

Mercedes Benz
000 295 39 35



63 451 156 CLUTCH HOSE

Mercedes Benz
000 295 14 35



21 290 000 CLUTCH MASTER CYLINDER

Mercedes Benz
001 295 30 06

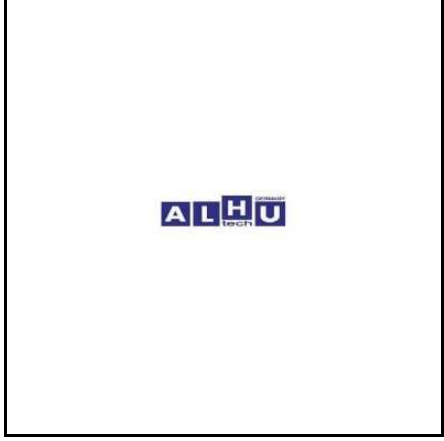

Getriebe / Gear

21 290 001 CLUTCH MASTER CYLINDER

Mercedes Benz
002 295 07 06



21 290 002 CLUTCH MASTER CYLINDER

Mercedes Benz
002 295 04 06



21 290 003 CLUTCH MASTER CYLINDER

Mercedes Benz
001 295 53 06



21 290 506 CLUTCH MASTER CYLINDER

Mercedes Benz
001 295 95 06



Getriebe / Gear

28 000 005 CLUTCH MASTER CYLINDER

Mercedes Benz
001 295 60 06



25 000 000 CLUTCH PIPE

Mercedes Benz
381 290 16 14



25 000 001 CLUTCH PIPE

Mercedes Benz
381 290 18 14



25 000 002 CLUTCH PIPE

Mercedes Benz
381 290 19 14



Getriebe / Gear

25 000 003 CLUTCH PIPE

Mercedes Benz
381 290 20 14

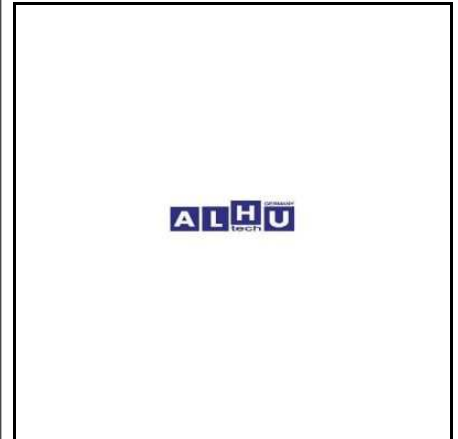

21 254 006 CLUTCH RELEASE AXLE

Mercedes Benz
650 254 00 06



21 254 206 CLUTCH RELEASE AXLE

Mercedes Benz
655 254 02 06



25 250 007 CLUTCH RELEASE AXLE

Mercedes Benz
620 254 02 07

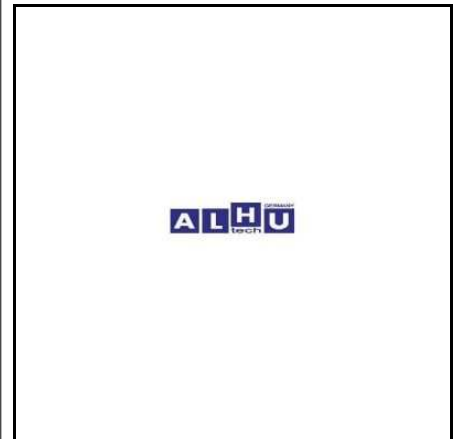

Getriebe / Gear

21 586 206 CLUTCH RELEASE AXLE KIT

Mercedes Benz
655 254 02 06 S



11 250 115 CLUTCH RELEASE BEARING

W 168

Mercedes Benz
002 250 18 15



21 250 002 CLUTCH RELEASE BEARING

Mercedes Benz
002 250 49 15
003 250 14 15

MAN
81.30550.0117



21 250 105 CLUTCH RELEASE BEARING

Mercedes Benz
002 250 51 15

MAN
81.30550.0105

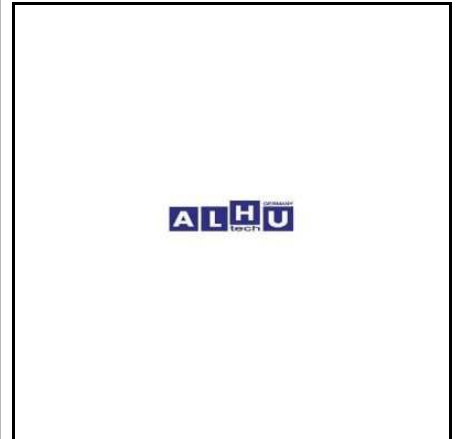

Getriebe / Gear

21 250 315 CLUTCH RELEASE BEARING

Mercedes Benz
002 250 73 15



21 250 415 CLUTCH RELEASE BEARING

Mercedes Benz
002 250 74 15



21 250 615 CLUTCH RELEASE BEARING

Mercedes Benz
002 250 72 15
002 250 76 15



21 250 815 CLUTCH RELEASE BEARING

Mercedes Benz
002 250 78 15
002 250 81 15
002 250 98 15



Getriebe / Gear

21 250 813 CLUTCH RELEASE LEVER

Mercedes Benz
650 250 38 13

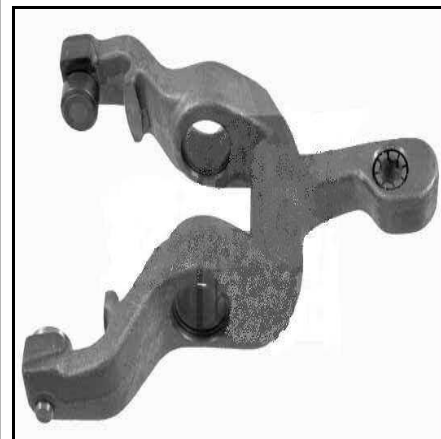

21 251 513 CLUTCH RELEASE LEVER

Mercedes Benz
655 250 15 13



21 254 708 CLUTCH RELEASE LEVER

Mercedes Benz
620 254 07 08



21 254 214 CLUTCH RELEASE SHAFT KIT

Mercedes Benz
620 250 02 14

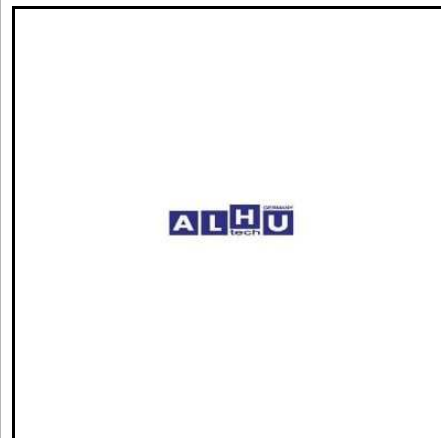

Getriebe / Gear

21 254 314 CLUTCH RELEASE SHAFT KIT

Mercedes Benz
650 254 00 06 S

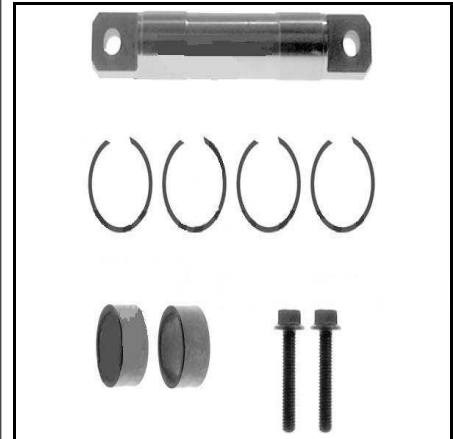

21 250 014 CLUTCH RELEASE SHAFT REP. KIT

Mercedes Benz
385 250 00 14

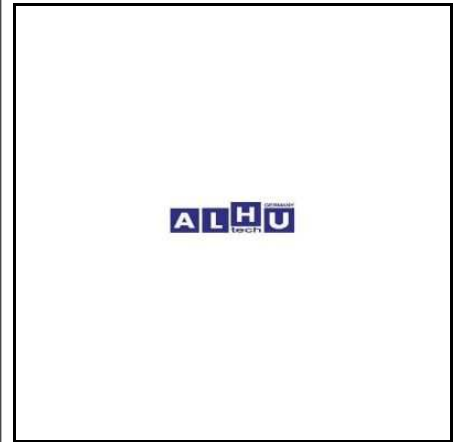

21 250 114 CLUTCH RELEASE SHAFT REP. KIT

Mercedes Benz
363 250 01 14

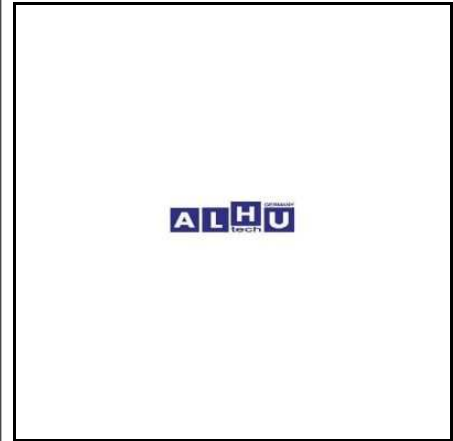

21 252 646 CLUTCH REPAIR KIT

Mercedes Benz
000 252 06 46

Iveco
93161755

DAF
1328793

MAN
81.30300.6002
81.30300.6003

weitere/another

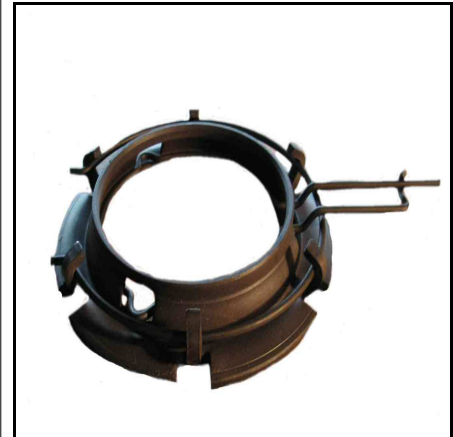

Getriebe / Gear

25 250 010 CLUTCH REPAIR KIT

Mercedes Benz
000 252 03 46

MAN
81.30300.6004

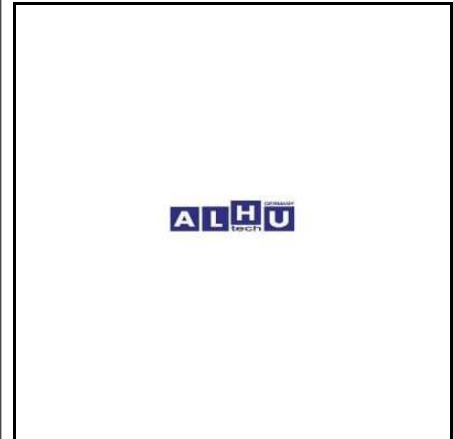

21 290 004 CLUTCH SLAVE CYLINDER

Mercedes Benz
000 295 83 07

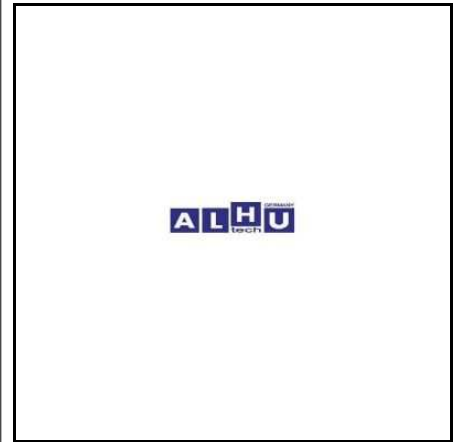

22 268 157 COVER

Mercedes Benz
620 268 01 57

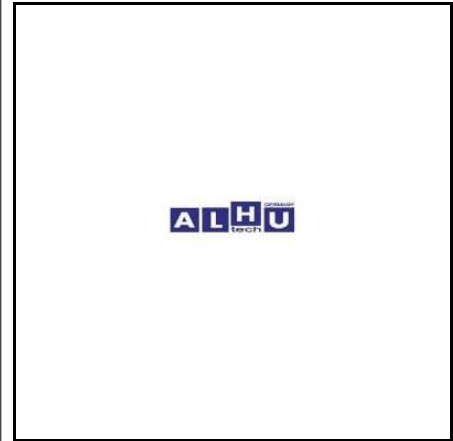

63 451 655 GEAR CHANGE SERVO



Mercedes Benz
002 260 06 63

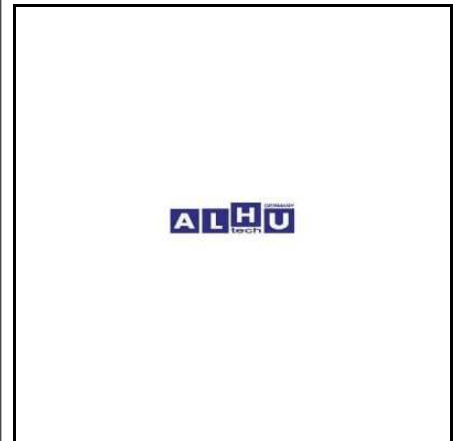

Getriebe / Gear

24 051 098 GEAR LEVER ACTUATOR

Mercedes Benz
000 260 40 98

TA501
626321AM



25 268 097 GEAR LEVER BOOT

Mercedes Benz
620 268 00 97



63 451 214 GEAR SHIFT BOOT

Mercedes Benz
620 268 01 96



63 451 656 GEARSHIFT ACTUATOR

Mercedes Benz
001 260 34 63

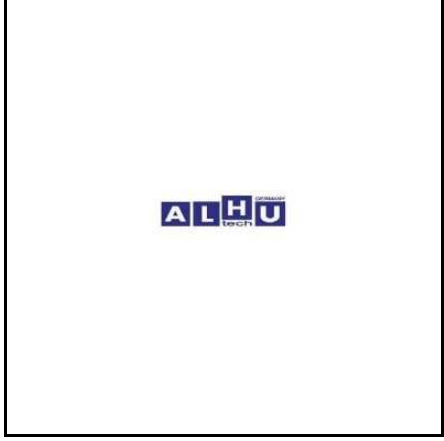

Getriebe / Gear

63 450 843 GEARSHIFT PIN

Mercedes Benz
385 268 14 74

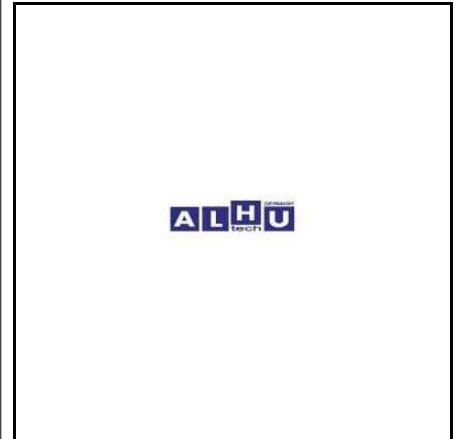

63 450 086 GUIDE RING

Mercedes Benz
000 267 10 59

MAN
81.91710.0357

Iveco
08190758

ZF
0750 112 066

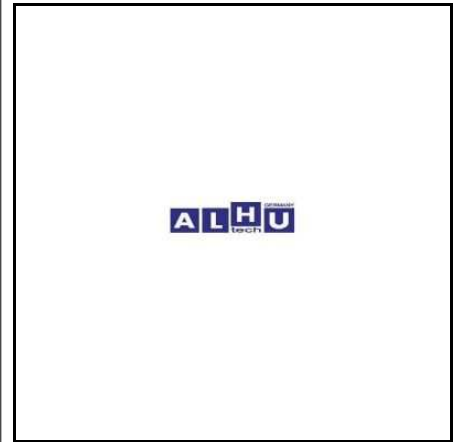

63 450 111 LATCH STOP

MAN
81.32545.0033

ZF
1315 207 014

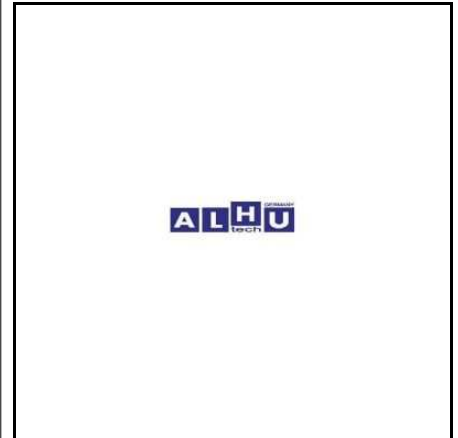

22 260 457 MULTIWAY VALVE

Mercedes Benz
000 260 14 57

Wabco
571.003.104.0

MAN
81.32734.6001



Getriebe / Gear

63 450 584 REPAIR KIT
for clutch slave cylinder

Mercedes Benz
000 290 09 11

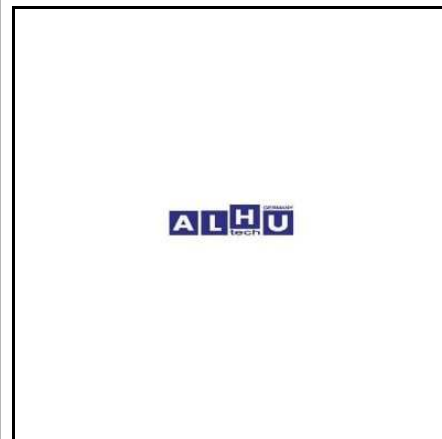

63 450 585 REPAIR KIT
for gear mechanism

Mercedes Benz
000 260 49 98

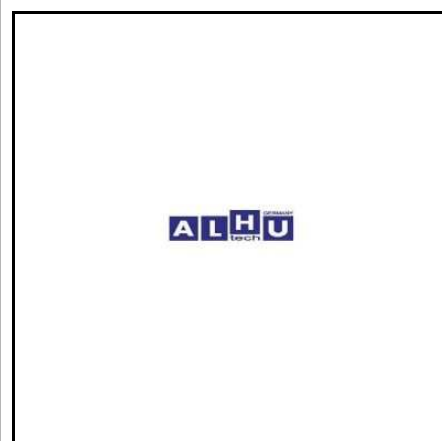

63 451 320 REPAIR KIT GEARBOX SHIFT

Mercedes Benz
970 260 02 98

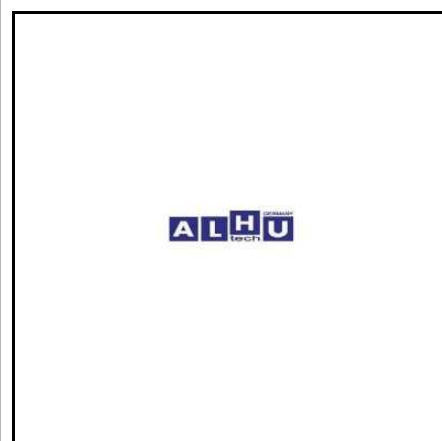

28 000 004 RESERVOIR

Mercedes Benz
000 295 17 15

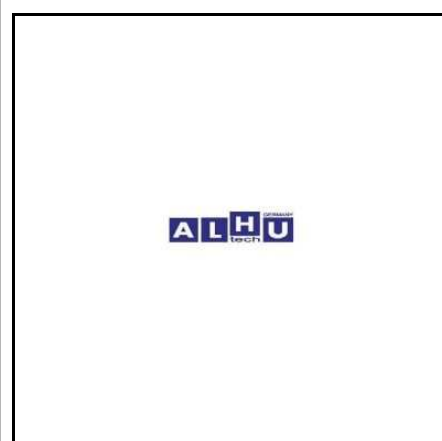

Getriebe / Gear

25 290 439 ROD, MASTER CYLINDER

Mercedes Benz
673 290 04 39

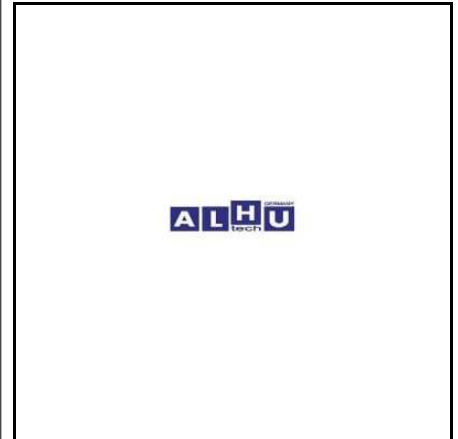

25 250 006 ROLLER, CLUTCH FORK

Mercedes Benz
000 254 00 17

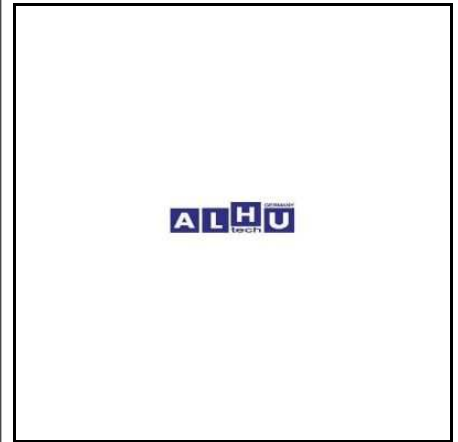

22 260 040 SHIFT KNOB

Mercedes Benz
620 260 00 40

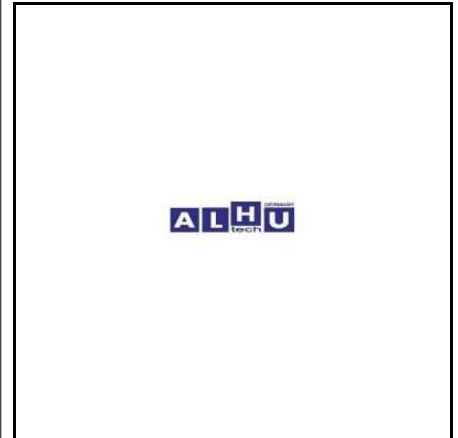

22 268 042 SHIFT KNOB

Mercedes Benz
620 268 00 42



Getriebe / Gear

63 450 838 SHIFT KNOB	
Mercedes Benz 000 268 05 42	ZF 6038 323 060
MAN 81.97010.6001	



22 422 010 SHIFTING CYLINDER	
Mercedes Benz 000 260 47 63	Wabco 422.010.010.0
MAN 81.32735.6040	ZF 0750 132 009



22 422 012 SHIFTING CYLINDER	
Mercedes Benz 000 260 46 63	Wabco 422.010.012.0
MAN 81.32735.6041	ZF 0750 132 019



22 422 014 SHIFTING CYLINDER	
Mercedes Benz 000 260 54 63	
Wabco 422.010.014.0	



Getriebe / Gear

25 260 002 SHIFTING ROD

Mercedes Benz
385 260 94 33



22 260 357 SHIFTING VALVE

Mercedes Benz
001 260 63 57

MAN
81.32550.0003



22 260 557 SHIFTING VALVE

Mercedes Benz
001 260 84 57

KNORR
I90498



22 260 857 SHIFTING VALVE

Mercedes Benz 001 260 27 57	MAN 81.32734.6027
KNORR SV 3302	



Getriebe / Gear

25 260 001 SHIFTING VALVE

Mercedes Benz
385 260 05 63



25 260 003 SHIFTING VALVE

Mercedes Benz 001 260 02 57	MAN 81.32734.6015
KNORR SV 3360	ZF 0750 132 008



616710 SLIDING BLOCK

Mercedes Benz 000 268 11 49	ZF 1297 306 120
MAN 81.32526.0031	



22 260 757 SPLITTER VALVE

Mercedes Benz 001 260 67 57	MAN 81.52170.6128
KNORR I76936 SV 3368	ZF 6038 202 003



Getriebe / Gear

616709 THRUST PIECE	
<p>Mercedes Benz 000 264 08 39</p> <p>MAN 81.32510.0013</p>	<p>ZF 1297 304 436</p>



22 036 000 3/2 DIRECTIONAL CONTROL VALVE	
<p>Mercedes Benz 001 997 61 36</p> <p>KNORR I66920</p>	<p>MAN 81.52185.6023</p>



Kabine / Cabin

21 541 303 BATTERY COVER

Mercedes Benz
620 541 03 03



26 541 103 BATTERY COVER

ACTROS

Mercedes Benz
941 541 00 03
941 541 01 03



28 820 221 BLINKER LAMP

Mercedes Benz
940 820 02 21



28 820 321 BLINKER LAMP

Mercedes Benz
940 820 03 21



Kabine / Cabin

28 820 421 BLINKER LAMP

Mercedes Benz
940 820 04 21



28 826 321 BLINKER LAMP
left

Mercedes Benz
973 820 03 21



28 826 421 BLINKER LAMP
right

Mercedes Benz
973 820 04 21



26 820 021 BLINKER LAMP

ATEGO AXOR

Mercedes Benz
941 820 10 21



Kabine / Cabin

63 450 108 BLINKER LAMP
complete/ with E mark / left
ACTROS

Mercedes Benz
941 820 05 21

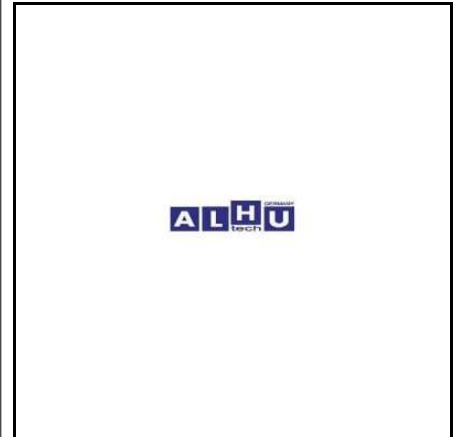

63 450 109 BLINKER LAMP
complete/ with E mark / right
ACTROS

Mercedes Benz
941 820 09 21

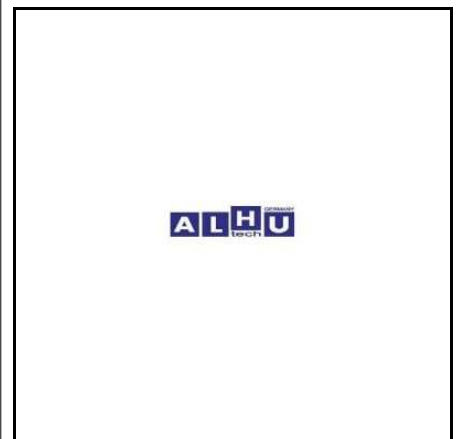

63 451 399 BLINKER LAMP
left
ATEGO

Mercedes Benz
973 820 01 21

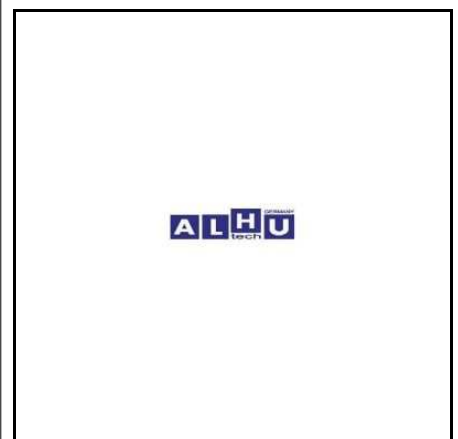

18 835 285 BLOWER MOTOR

Mercedes Benz
000 835 22 85



Kabine / Cabin

18 835 385 BLOWER MOTOR

Mercedes Benz
000 835 23 85

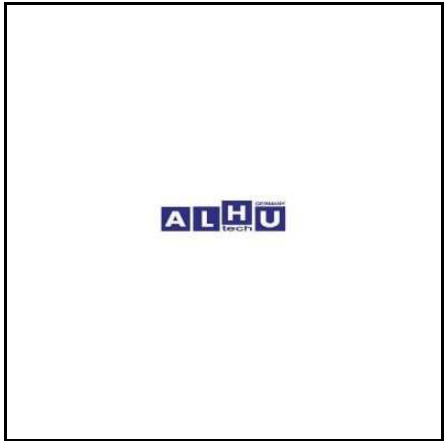

28 830 001 BLOWER MOTOR

Mercedes Benz
003 830 05 08

Behr/Hella
8EW 351 029-041



28 830 002 BLOWER MOTOR

Mercedes Benz
002 830 84 08



28 830 008 BLOWER MOTOR

Mercedes Benz
000 830 98 08

Bosch
0 130 111 015



Kabine / Cabin

28 830 051 BLOWER MOTOR

Bosch
0 130 007 051



28 830 108 BLOWER MOTOR

F 2000

Mercedes Benz
001 830 03 08

MAN
81.61930.0055

Bosch
0 130 111 130



28 830 208 BLOWER MOTOR

L 2000 M 2000

Mercedes Benz
001 830 02 08

MAN
81.61930.0042

Bosch
0 130 111 116

Volvo
8157216



28 830 308 BLOWER MOTOR

Mercedes Benz
000 830 93 08

MAN
81.61930.0036

Bosch
0 130 063 029



Kabine / Cabin

28 830 508 BLOWER MOTOR

Mercedes Benz
000 830 95 08
001 830 04 08



28 830 708 BLOWER MOTOR

Mercedes Benz
001 830 87 08

Bosch
0 130 063 514



28 830 908 BLOWER MOTOR

Mercedes Benz
000 820 62 42



63 450 206 BLOWER MOTOR

Mercedes Benz
001 830 27 08

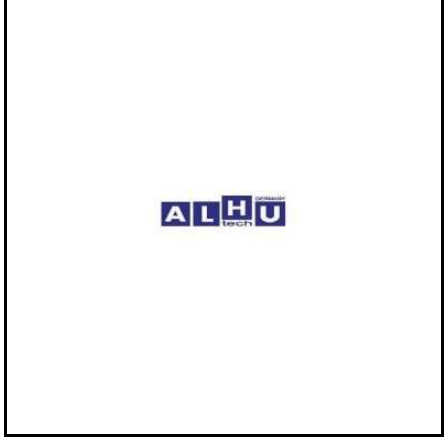

Kabine / Cabin

28 991 912 BOLT

Mercedes Benz
000 991 09 12

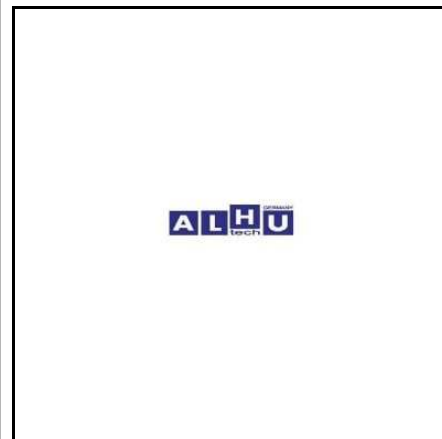

63 450 987 BOOT, FAN SHROUD

Mercedes Benz
620 505 00 86

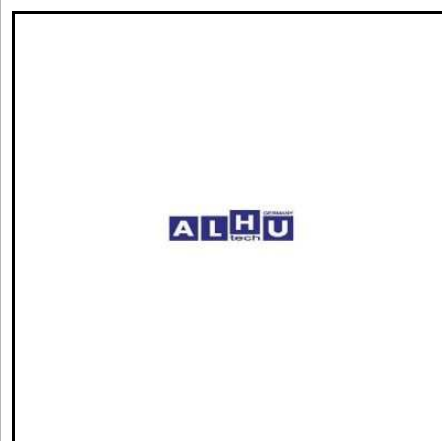

28 827 012 BUMPER COVER

Mercedes Benz
641 988 05 35

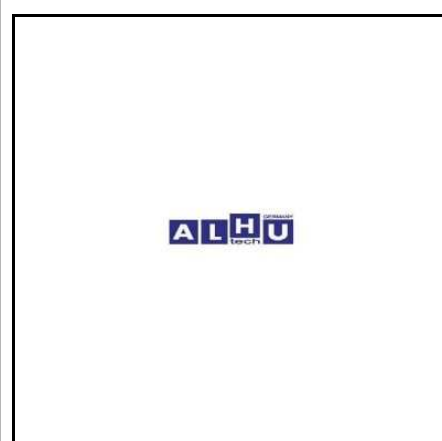

28 891 417 CABIN BUSHING

Mercedes Benz
620 891 04 17

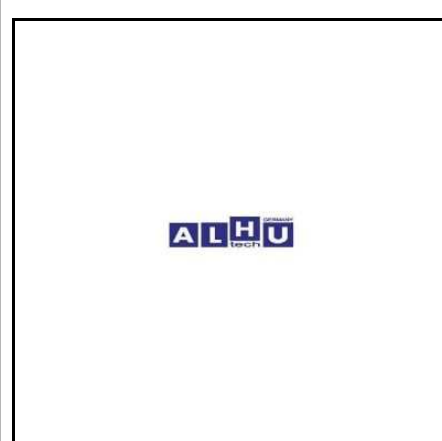

Kabine / Cabin

63 450 470 CABIN BUSHING

Mercedes Benz
620 891 00 17



63 450 472 CABIN BUSHING

Mercedes Benz
942 317 23 12



63 450 181 CABIN BUSHING

Mercedes Benz
942 317 18 12



28 553 405 CABIN CYLINDER

ACTROS

Mercedes Benz
002 553 10 05



Kabine / Cabin

28 553 505 CABIN CYLINDER

Mercedes Benz
001 553 42 05



28 553 605 CABIN CYLINDER

Mercedes Benz
001 553 43 05



28 553 705 CABIN CYLINDER

Mercedes Benz
002 553 92 05



28 553 805 CABIN CYLINDER

Mercedes Benz
001 553 35 05



Kabine / Cabin

28 553 905 CABIN CYLINDER

Mercedes Benz
001 553 25 05



28 553 906 CABIN CYLINDER

Mercedes Benz
002 553 91 05



28 553 907 CABIN CYLINDER

Mercedes Benz
002 553 68 05



28 554 005 CABIN CYLINDER

Mercedes Benz
001 553 36 05



Kabine / Cabin

28 554 105 CABIN CYLINDER

Mercedes Benz
002 553 88 05



28 554 705 CABIN CYLINDER

Mercedes Benz
001 553 87 05



28 619 005 CABIN FILTER

Mercedes Benz
000 830 11 18

Mann + Hummel
CU 3869



28 619 006 CABIN FILTER

ACTROS

Mercedes Benz
000 830 13 18
000 830 34 18

Mann + Hummel
CUK3823



Kabine / Cabin

28 619 007 CABIN FILTER

Mercedes Benz
000 830 12 18

Mann + Hummel
CU 3855

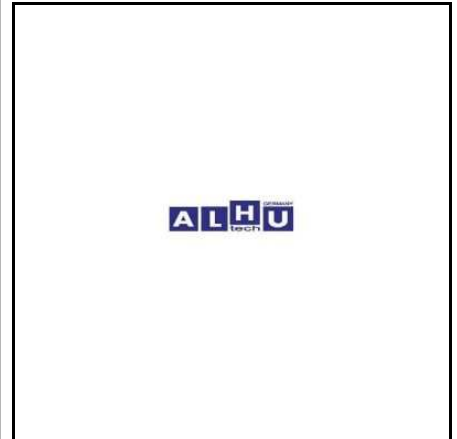

28 619 008 CABIN FILTER

Mercedes Benz
000 830 15 18

Mann + Hummel
CUK 4245



28 835 247 CABIN FILTER

Mercedes Benz
940 835 02 47

Mann + Hummel
CU 4408



28 835 747 CABIN FILTER

Mercedes Benz
001 835 07 47



Kabine / Cabin

21 203 011 CABIN HOSE

Mercedes Benz
387 553 03 82



26 000 000 CABIN HOSE

Mercedes Benz
655 553 05 82



63 450 738 CABIN HOSE

Mercedes Benz
380 553 00 82



63 450 739 CABIN HOSE

Mercedes Benz
387 553 01 82



Kabine / Cabin

63 450 740 CABIN HOSE

Mercedes Benz
942 553 01 82

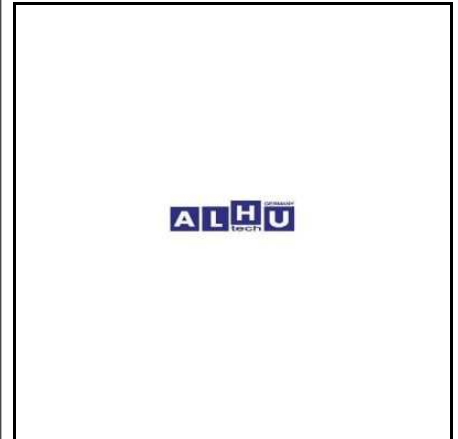

63 450 741 CABIN HOSE

Mercedes Benz
620 553 03 82

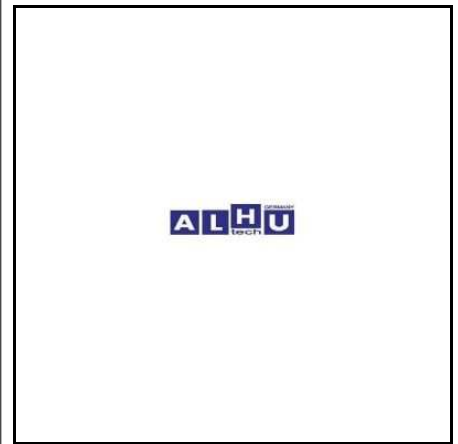

63 450 743 CABIN HOSE

Mercedes Benz
942 553 28 82

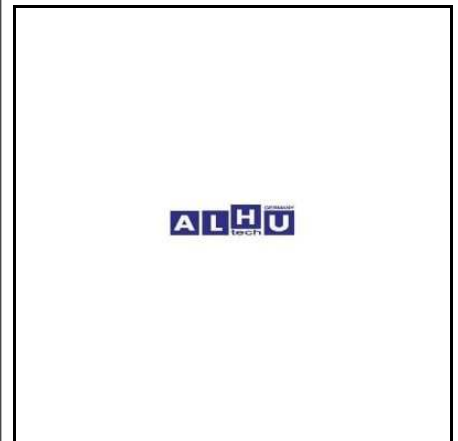

28 618 283 CABIN LOCK

ACTROS

Mercedes Benz
942 310 02 83



Kabine / Cabin

28 618 383 CABIN LOCK

ACTROS

Mercedes Benz
942 310 03 83



28 618 483 CABIN LOCK

AXOR

Mercedes Benz
942 310 04 83



28 890 389 CABIN LOCK

Mercedes Benz
000 890 23 89



28 553 111 CABIN PUMP

ACTROS AXOR

Mercedes Benz
000 553 99 01



Kabine / Cabin

28 553 112 CABIN PUMP

ACTROS

Mercedes Benz
001 553 37 01



28 553 113 CABIN PUMP

ACTROS

Mercedes Benz
001 553 36 01



28 553 114 CABIN PUMP

Mercedes Benz
001 553 34 01



28 553 115 CABIN PUMP

Mercedes Benz
001 553 38 01

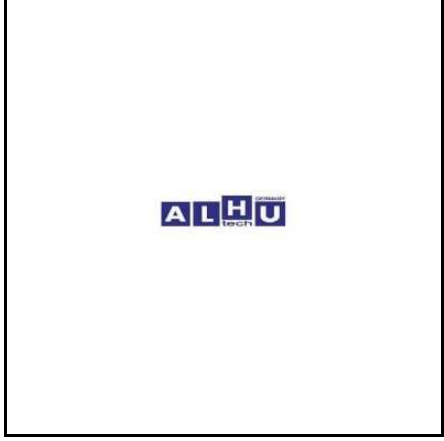

Kabine / Cabin

28 553 116 CABIN PUMP

Mercedes Benz
001 553 41 01



28 553 301 CABIN PUMP

Mercedes Benz
001 553 00 01



28 553 401 CABIN PUMP

Mercedes Benz
001 553 40 01

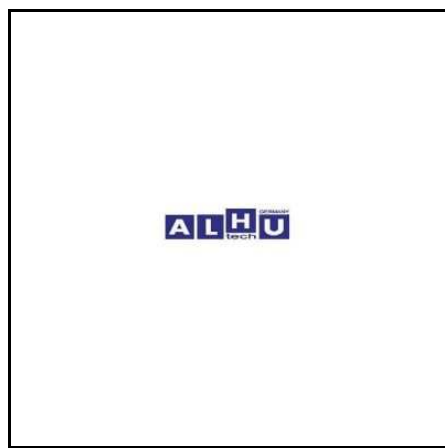

28 553 801 CABIN PUMP

ACTROS

Mercedes Benz
001 553 59 01



Kabine / Cabin

28 553 901 CABIN PUMP

SK

Mercedes Benz
000 553 39 01
000 553 40 01
000 553 69 01



63 450 836 CABIN PUMP GASKET SET

Mercedes Benz
000 550 15 07



21 891 005 CABIN SHOCK ABSORBER

Mercedes Benz
000 891 10 05



21 891 205 CABIN SHOCK ABSORBER

Mercedes Benz
000 891 22 05



Kabine / Cabin

28 890 001 CABIN SHOCK ABSORBER

Mercedes Benz
942 890 29 19



28 890 053 CABIN SHOCK ABSORBER

Mercedes Benz
942 890 28 19



28 890 054 CABIN SHOCK ABSORBER

Mercedes Benz
942 890 31 19
943 890 09 19



63 450 025 CABIN SHOCK ABSORBER

Mercedes Benz
942 890 02 19
942 890 56 19
942 890 60 19

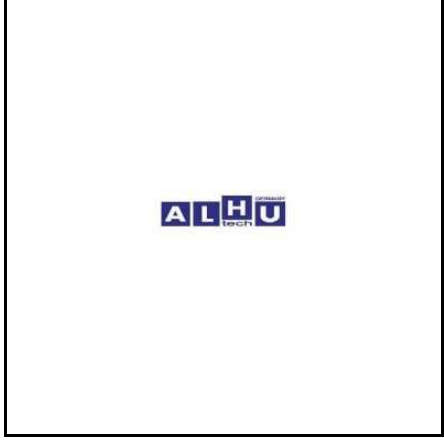

Kabine / Cabin

63 450 182 CABIN SHOCK ABSORBER

Mercedes Benz
943 890 03 19

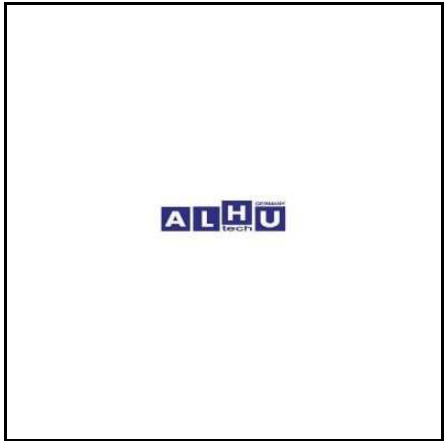

28 891 051 CABIN SPRING

Mercedes Benz
387 891 05 51



28 891 151 CABIN SPRING

Mercedes Benz
387 891 10 51



28 891 251 CABIN SPRING

Mercedes Benz
620 891 00 51



Kabine / Cabin

28 891 351 CABIN SPRING

Mercedes Benz
620 891 01 51



28 750 359 CABLE ENGINE HOOD

Mercedes Benz
901 750 03 59

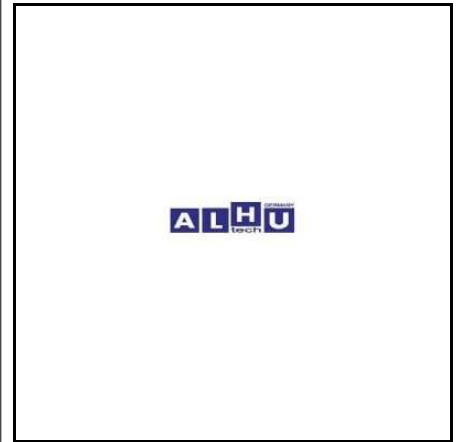

26 760 004 CABLE, DOOR CONTROL

ACTROS

Mercedes Benz
641 760 00 04

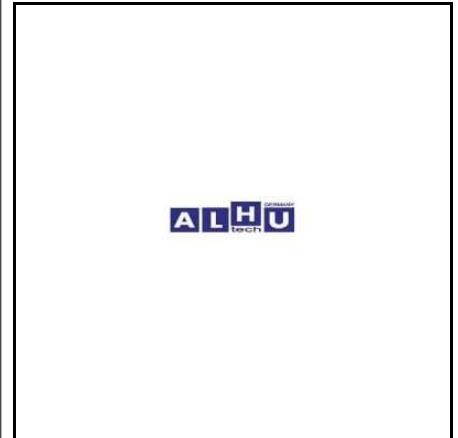

28 760 104 CABLE, DOOR CONTROL

Mercedes Benz
901 760 01 04

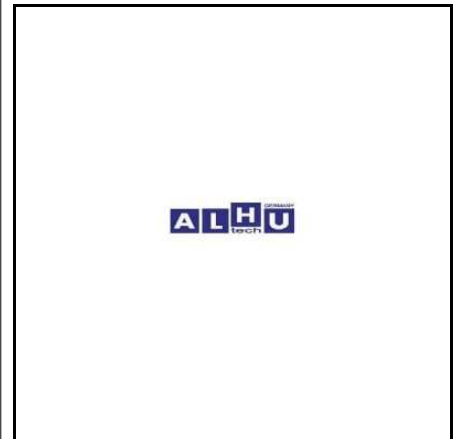

Kabine / Cabin

26 890 170 CABLE, STORAGE BOX

Mercedes Benz
941 890 01 70



58 290 001 CLIP

Mercedes Benz
005 988 82 78



25 540 347 COMBINATION INSTRUMENT

Mercedes Benz
002 540 23 47



26 723 120 DOOR CHECK

Mercedes Benz
941 723 01 20



Kabine / Cabin

28 720 066 DOOR CONTROL

Mercedes Benz
941 720 00 66



28 720 166 DOOR CONTROL

Mercedes Benz
941 720 01 66



18 760 361 DOOR HANDLE

SPRINTER

Mercedes Benz
901 760 13 61



28 725 279 DOOR HANDLE
left

Mercedes Benz
381 725 02 79



Kabine / Cabin

28 725 379 DOOR HANDLE
right

Mercedes Benz
381 725 03 79

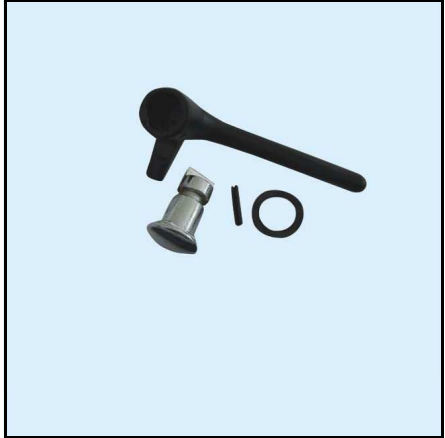

28 760 059 DOOR HANDLE

Mercedes Benz
381 760 00 59



28 760 061 DOOR HANDLE
inner, left

Mercedes Benz
322 760 00 61



28 760 161 DOOR HANDLE
inner, left

Mercedes Benz
322 760 01 61



Kabine / Cabin

28 760 259 DOOR HANDLE

left

Mercedes Benz
641 760 02 59



28 760 359 DOOR HANDLE

ATEGO

Mercedes Benz
000 760 13 59



28 760 559 DOOR HANDLE

right

Mercedes Benz
641 760 03 59



28 760 659 DOOR HANDLE

front, right - without lock -

Mercedes Benz
941 760 05 59

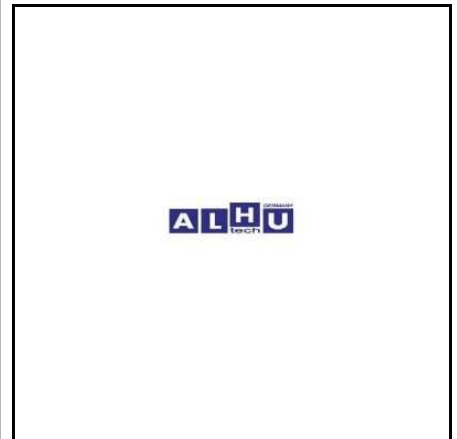

Kabine / Cabin

28 760 659S DOOR HANDLE
front, right - with lock -

Mercedes Benz
670 760 02 05
941 760 05 59



28 760 759 DOOR HANDLE
front, left - without lock -

Mercedes Benz
941 760 04 59



28 760 759S DOOR HANDLE
front, left - with lock -

Mercedes Benz
670 760 02 05
941 760 04 59



28 761 159 DOOR HANDLE

Mercedes Benz
943 760 01 59



Kabine / Cabin

28 761 259 DOOR HANDLE

Mercedes Benz
943 760 02 59



28 761 459 DOOR HANDLE

Mercedes Benz
641 760 04 59



28 761 559 DOOR HANDLE

Mercedes Benz
641 760 05 59



28 766 043 DOOR HANDLE
inner

Mercedes Benz
381 766 00 43



Kabine / Cabin

28 766 701 DOOR HANDLE
with keys

Mercedes Benz
322 766 07 01



28 766 901 DOOR HANDLE
with keys

Mercedes Benz
670 760 01 59



28 720 637 DOOR HINGE

Mercedes Benz
641 720 06 37

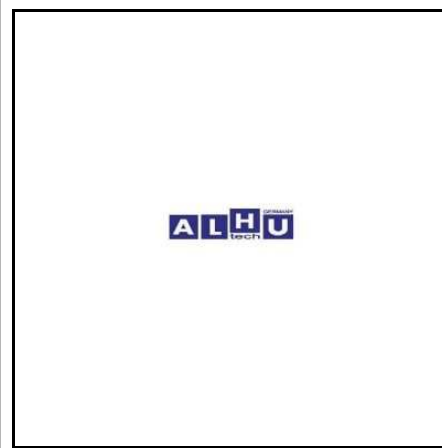

28 720 737 DOOR HINGE

Mercedes Benz
641 720 07 37

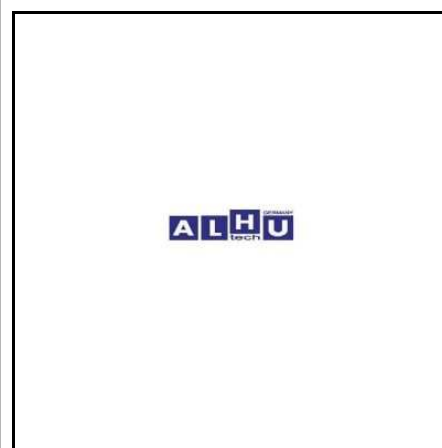

Kabine / Cabin

28 723 088 DOOR LEVER

Mercedes Benz
641 723 00 88
641 723 00 88 35



28 720 535 DOOR LOCK

Mercedes Benz
000 720 65 35



28 720 635 DOOR LOCK

Mercedes Benz
000 720 66 35



28 720 735 DOOR LOCK

Mercedes Benz
973 720 07 35



Kabine / Cabin

28 720 835 DOOR LOCK

Mercedes Benz
973 720 08 35



28 721 135 DOOR LOCK

Mercedes Benz
973 720 01 35



28 721 235 DOOR LOCK

Mercedes Benz
973 720 02 35



28 723 201 DOOR LOCK
left

Mercedes Benz
381 723 02 01

ALHU tech
28 723 201



Kabine / Cabin

28 723 301 DOOR LOCK
right

Mercedes Benz
381 723 03 01

ALHU tech
28 723 301



28 720 216 DOOR STOP

Mercedes Benz
322 720 02 16



28 720 616 DOOR TENSIONER

Mercedes Benz
000 720 06 16



28 827 013 FAN SHROUD

Mercedes Benz
942 505 09 55

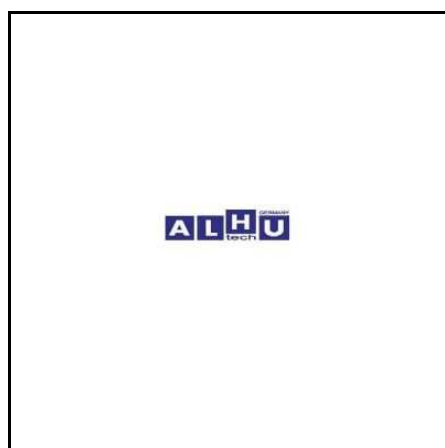

Kabine / Cabin

63 450 207 FLASHER LAMP

left, with E mark

Mercedes Benz

001 820 39 21

MAN

81.25225.6459

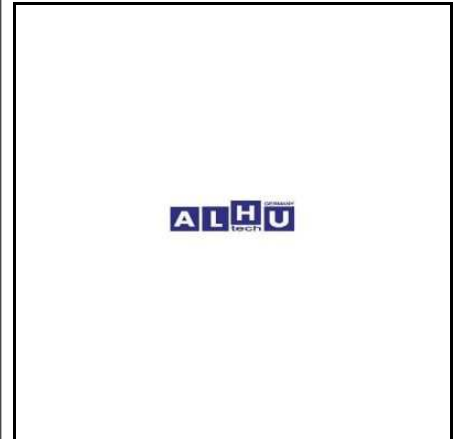

63 450 208 FLASHER LAMP

right, with E mark

Mercedes Benz

001 820 40 21

MAN

81.25225.6460

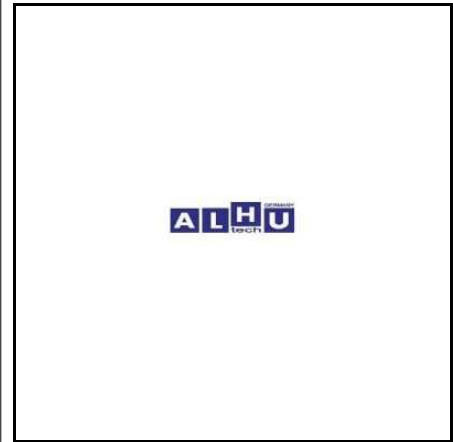

28 826 056 FOG LAMP

left with E-mark

ACTROS

Mercedes Benz

943 820 00 56

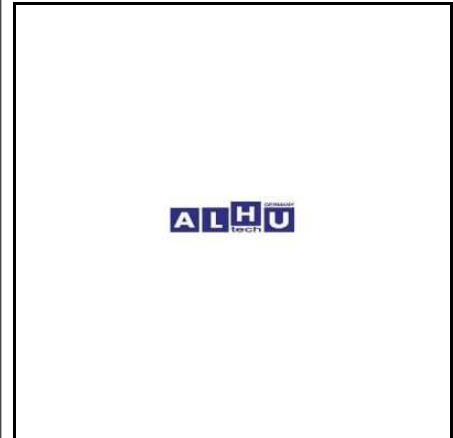

28 826 156 FOG LAMP

right with E mark

ACTROS

Mercedes Benz

943 820 01 56

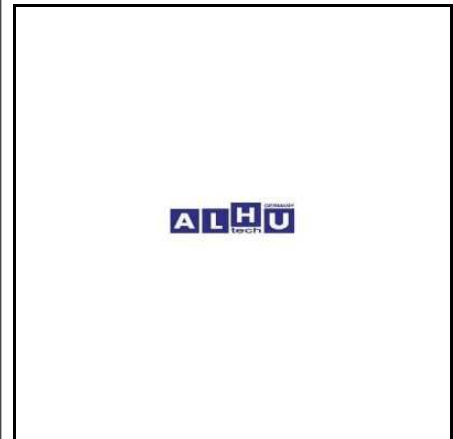

Kabine / Cabin

28 980 264 GAS SPRING

AXOR

Mercedes Benz
000 980 90 64

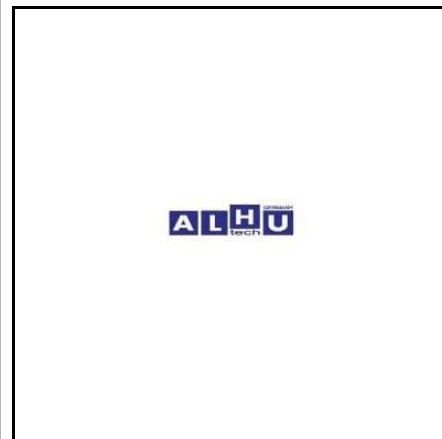

28 980 464 GAS SPRING

AXOR

Mercedes Benz
001 980 84 64



28 988 260 GLOVE BOX LOCK

Mercedes Benz
000 988 32 60

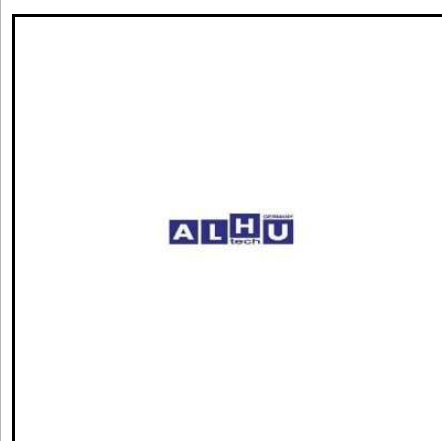

28 988 760 GLOVE BOX LOCK

Mercedes Benz
000 988 17 60

MAN
81.61444.0003



Kabine / Cabin

28 827 014 HANDLE

Mercedes Benz
941 880 00 20



28 891 472 HANDLE

Mercedes Benz
941 890 04 72



28 891 572 HANDLE

Mercedes Benz
941 890 05 72



28 760 459 HANDLE, DOOR AND SLIDING DOOR

VITO

Mercedes Benz
901 760 04 59



Kabine / Cabin

28 720 075 HANDLE, INSIDE, SLIDING DOOR

Mercedes Benz
673 720 00 75



28 820 161 HEAD LAMP
left

ACTROS

Mercedes Benz
941 820 61 61

Bosch
0 301 081 317



28 820 162 HEAD LAMP
left

AXOR II

Mercedes Benz
940 820 01 61



28 820 261 HEAD LAMP
right

ACTROS

Mercedes Benz
941 820 62 61

Bosch
0 301 081 318



Kabine / Cabin

28 820 262	HEAD LAMP
right	AXOR II
Mercedes Benz 940 820 02 61	

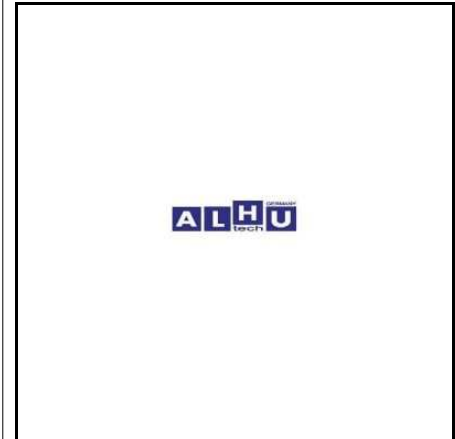

28 820 361	HEAD LAMP
left	ACTROS
Mercedes Benz 941 820 43 61	
Bosch 0 301 081 319	

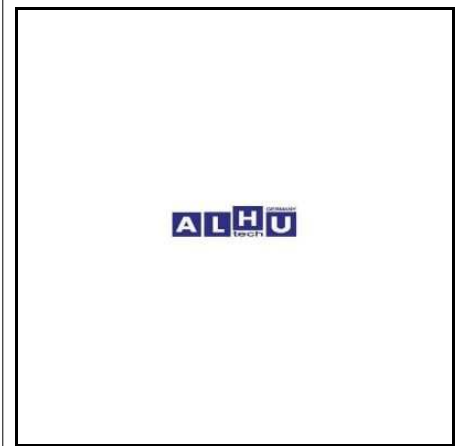

28 820 461	HEAD LAMP
right	ACTROS
Mercedes Benz 941 820 44 61	
Bosch 0 301 081 320	

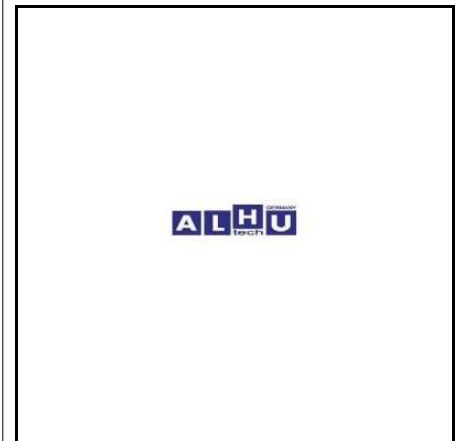

28 820 561	HEAD LAMP
left	ATEGO
Mercedes Benz 973 820 05 61	
Bosch 0 301 076 323	

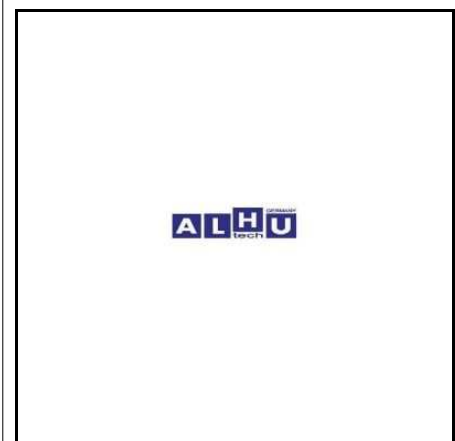

Kabine / Cabin

28 820 661 HEAD LAMP
 right
 ATEGO

Mercedes Benz
 973 820 06 61

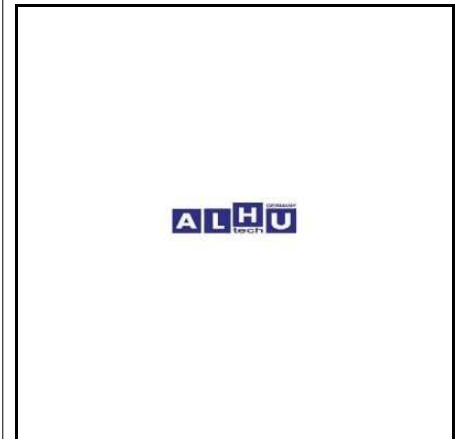

28 820 961 HEAD LAMP
 left
 ACTROS

Mercedes Benz
 941 820 55 61

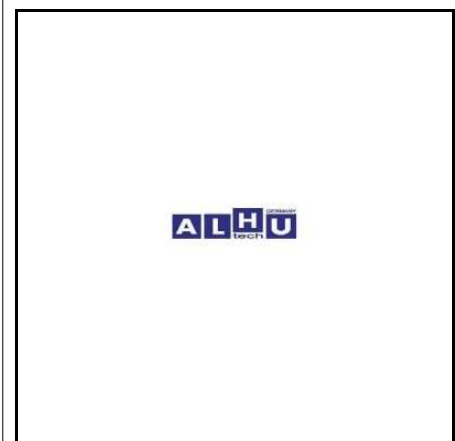

28 821 061 HEAD LAMP
 right
 ACTROS

Mercedes Benz
 941 820 56 61

Bosch
 0 301 081 322

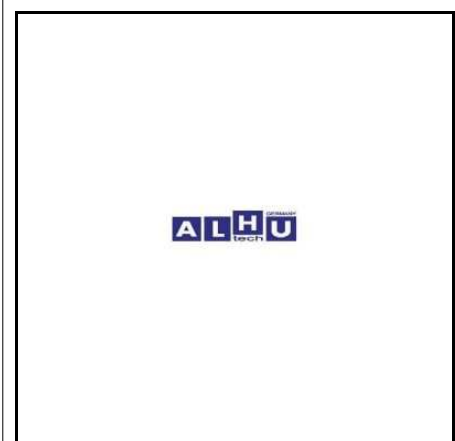

28 821 161 HEAD LAMP
 left
 ACTROS

Mercedes Benz
 941 820 51 61

Bosch
 0 301 081 121

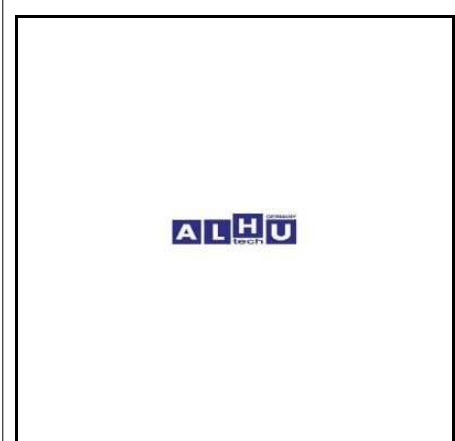

Kabine / Cabin

28 821 261	HEAD LAMP
right	ACTROS
Mercedes Benz	
941 820 52 61	

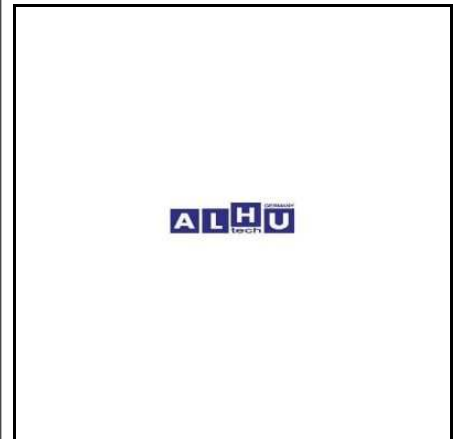

28 821 361	HEAD LAMP
left	ACTROS
Mercedes Benz	
943 820 03 61	

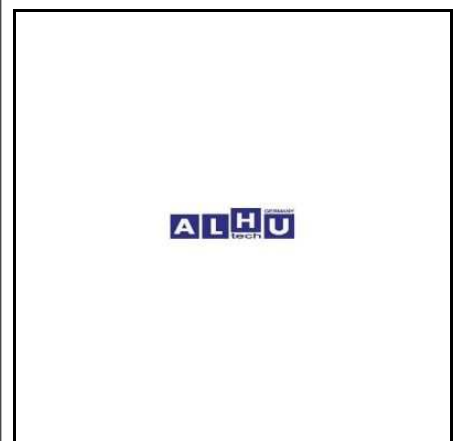

28 821 461	HEAD LAMP
right	ACTROS
Mercedes Benz	
943 820 04 61	

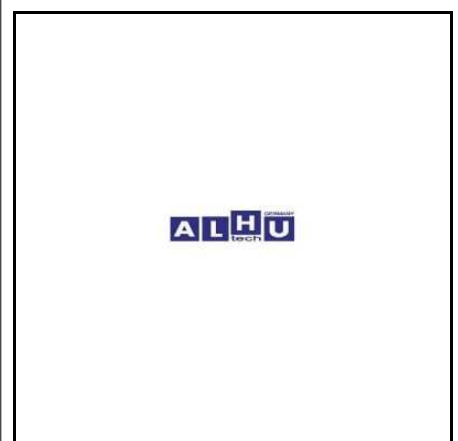

28 822 161	HEAD LAMP
left	ATEGO
Mercedes Benz	
973 820 01 61	

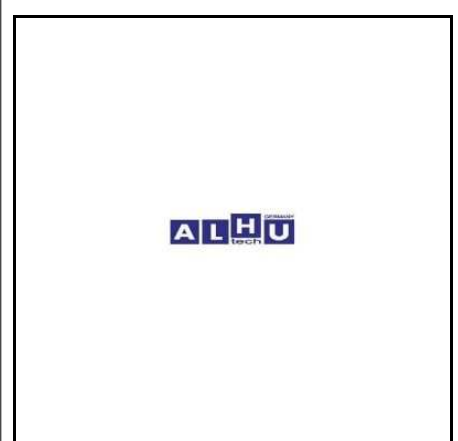

Kabine / Cabin

28 822 261	HEAD LAMP
right	ATEGO
<p>Mercedes Benz 973 820 02 61</p>	

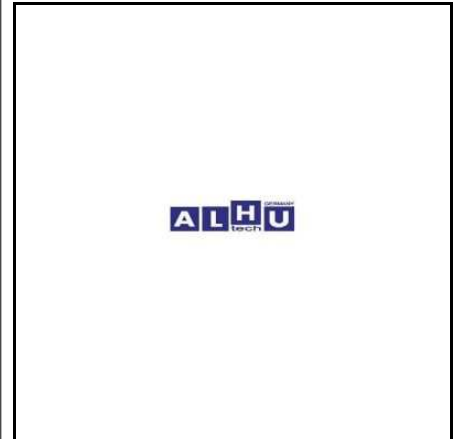

28 826 161	HEAD LAMP
<p>Mercedes Benz 943 820 01 61</p>	

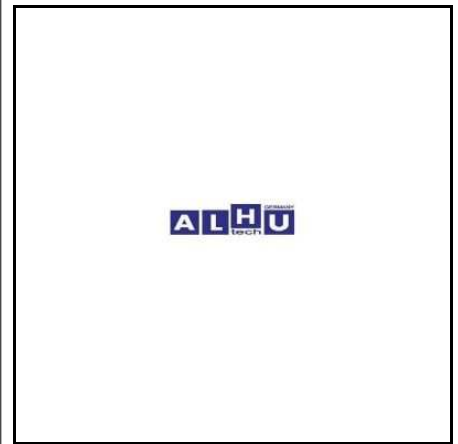

28 826 261	HEAD LAMP
<p>Mercedes Benz 943 820 02 61</p>	

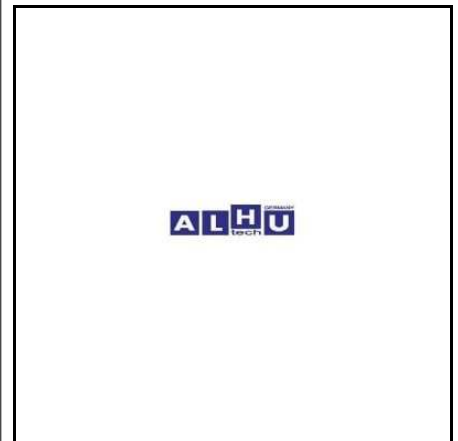

28 826 361	HEAD LAMP
<p>Mercedes Benz 941 820 53 61</p>	

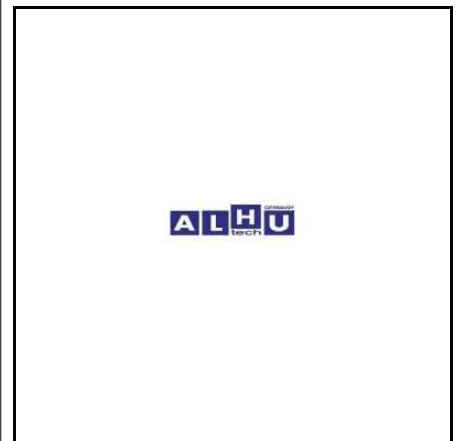

Kabine / Cabin

28 826 461 HEAD LAMP

Mercedes Benz
941 820 54 61

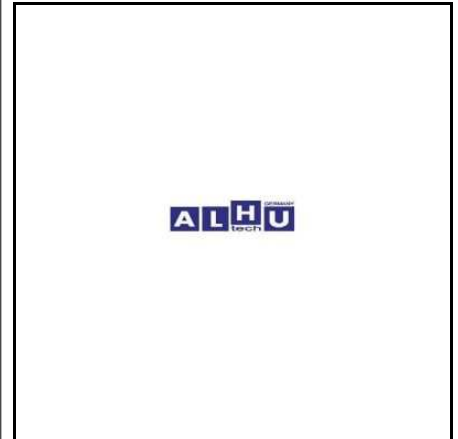

28 826 761 HEAD LAMP

Mercedes Benz
941 820 57 61

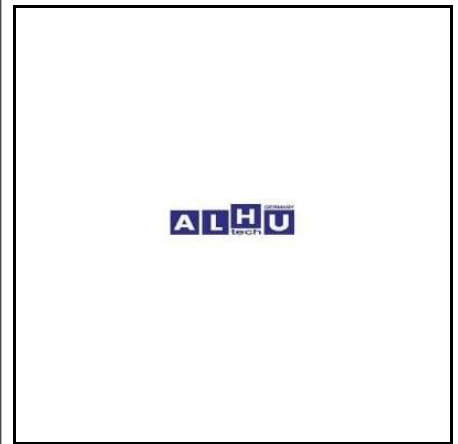

28 826 861 HEAD LAMP

Mercedes Benz
941 820 58 61

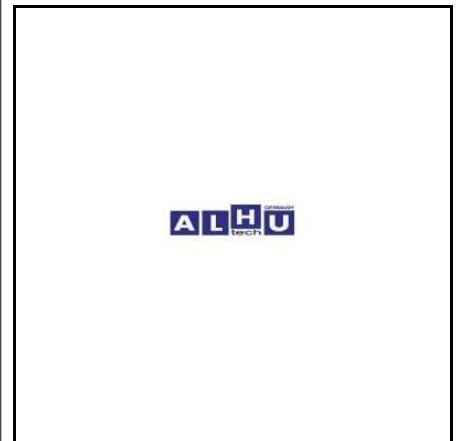

63 450 147 HEAD LAMP
right

ACTROS II

Mercedes Benz
943 820 06 61

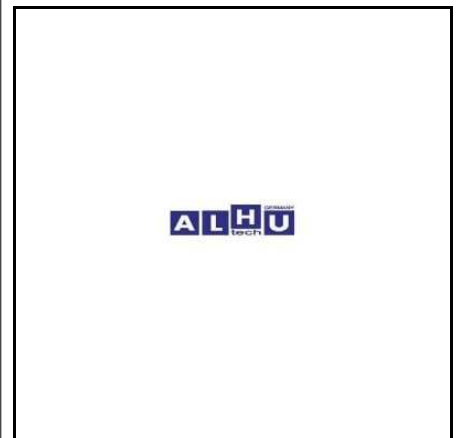

Kabine / Cabin

63 450 148 HEAD LAMP

Mercedes Benz
943 820 08 61

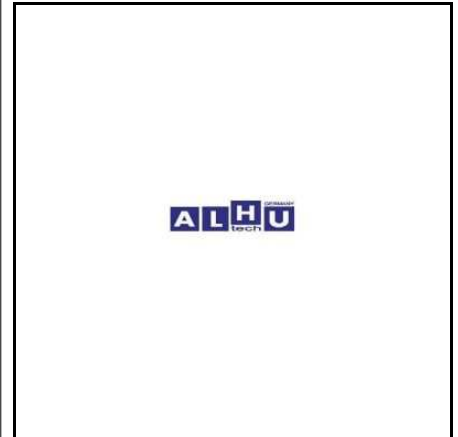

63 450 180 HEAD LAMP

Mercedes Benz
943 820 05 61

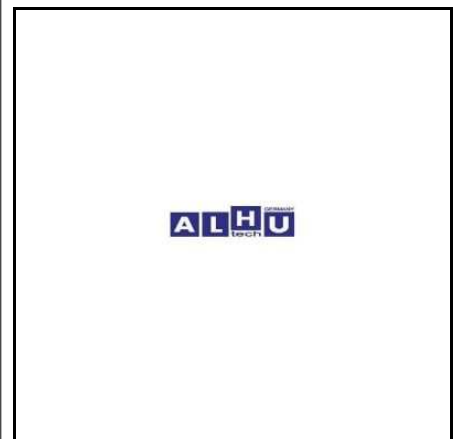

63 450 189 HEAD LAMP
left, for left hand drive
ACTROS

Mercedes Benz
941 820 33 61

Bosch
0 301 081 513

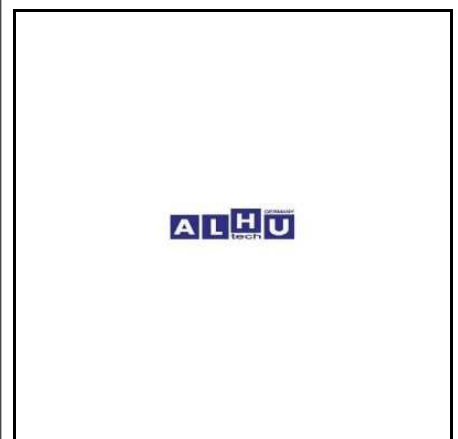

63 450 190 HEAD LAMP
right, for left hand drive
ACTROS

Mercedes Benz
941 820 34 61

Bosch
0 301 081 514

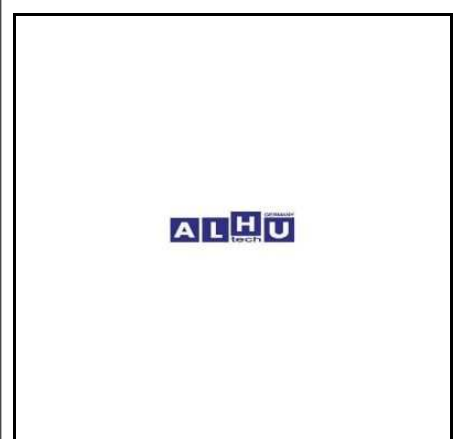

Kabine / Cabin

63 450 218	HEAD LAMP
ACTROS	
<p>Mercedes Benz 943 820 14 61</p>	

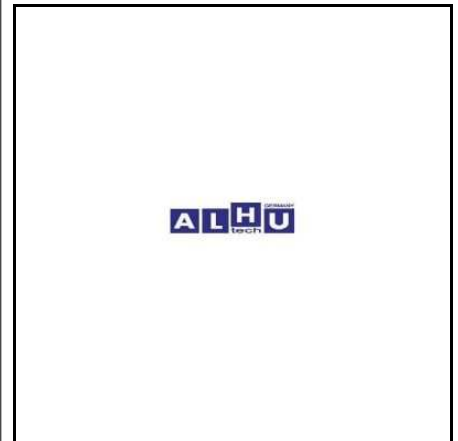

63 450 219	HEAD LAMP
ACTROS	
<p>Mercedes Benz 943 820 15 61</p>	

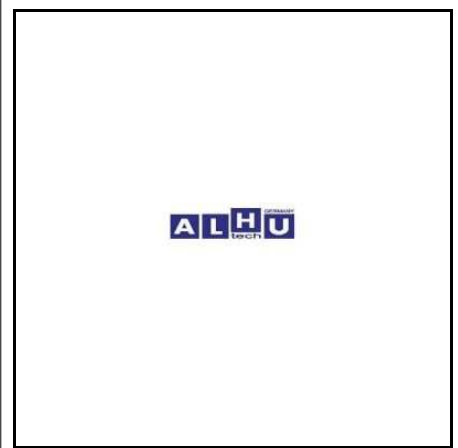

63 450 224	HEAD LAMP
ACTROS	
<p>Mercedes Benz 943 820 16 61</p>	

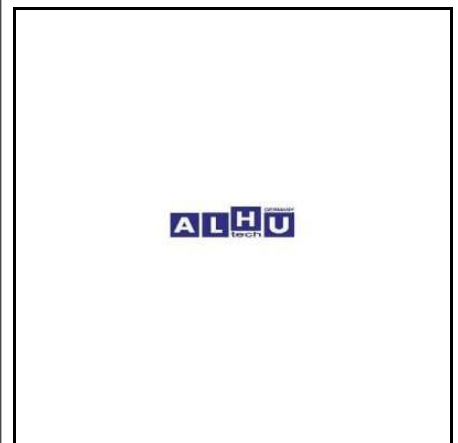

63 450 225	HEAD LAMP
ACTROS	
<p>Mercedes Benz 943 820 17 61</p>	

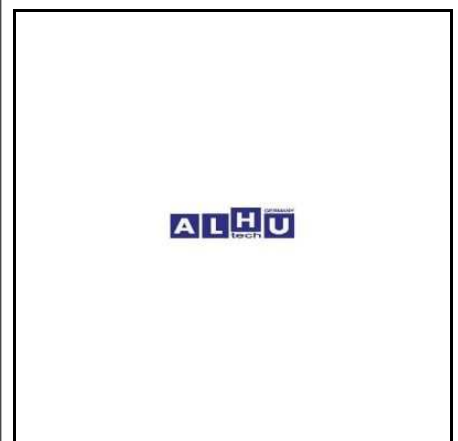

Kabine / Cabin

63 450 226 HEAD LAMP

ACTROS

Mercedes Benz
943 820 22 61

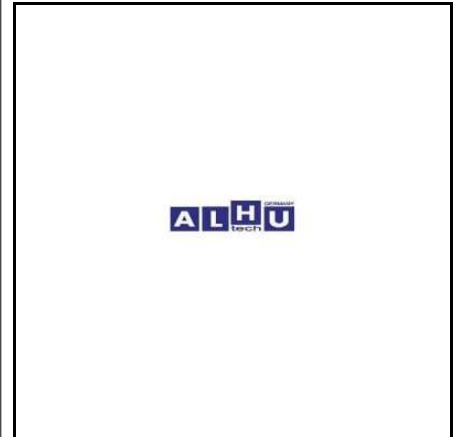

63 450 227 HEAD LAMP

ACTROS

Mercedes Benz
943 820 23 61

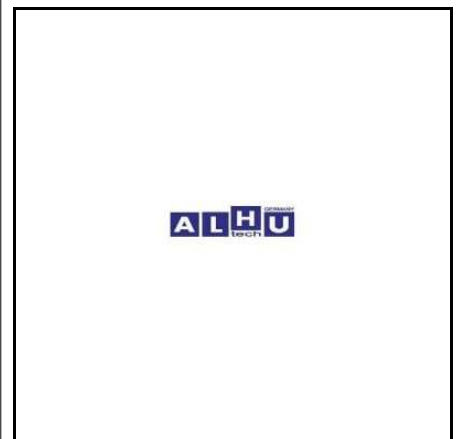

28 820 590 HEAD LAMP GLASS
left

ACTROS

Mercedes Benz
004 826 25 90

Bosch
1 305 621 834

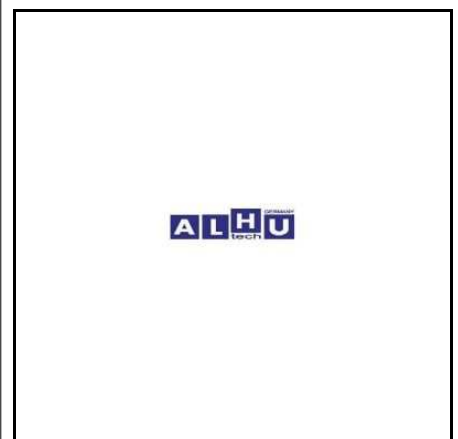

28 820 690 HEAD LAMP GLASS
right

ACTROS

Mercedes Benz
004 826 26 90

Bosch
1 305 621 835

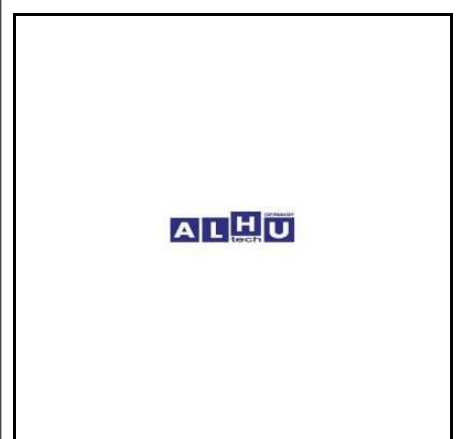

Kabine / Cabin

63 450 145	HEAD LAMP GLASS
with E mark	
ATEGO	
Mercedes Benz 000 826 44 10	

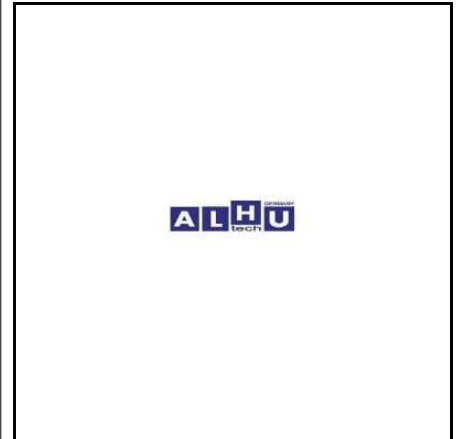

63 450 146	HEAD LAMP GLASS
with E mark	
ATEGO	
Mercedes Benz 000 826 45 10	

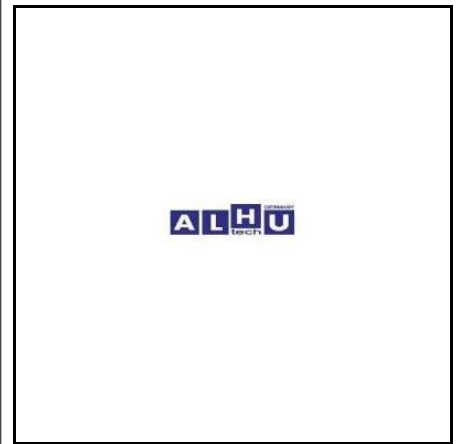

63 450 220	HEAD LAMP GLASS
ACTROS	
Mercedes Benz 000 826 47 10	

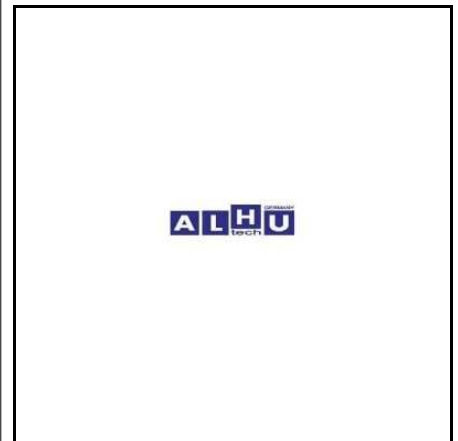

63 450 221	HEAD LAMP GLASS
ACTROS	
Mercedes Benz 000 826 46 10	

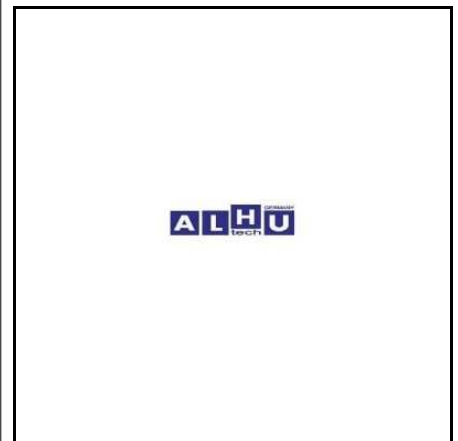

Kabine / Cabin

18 835 301 HEAT EXCHANGER

Mercedes Benz
001 835 83 01

Behr/Hella
8FH 351 312-271



18 835 401 HEAT EXCHANGER

Mercedes Benz
002 835 24 01

Behr/Hella
8FH 351 312-431



28 830 461 HEAT EXCHANGER

SK

Mercedes Benz
641 830 04 61



28 750 351 HINGE, BONNET, LEFT

AXOR

Mercedes Benz
973 750 03 51



Kabine / Cabin

28 750 451 HINGE, BONNET, RIGHT

AXOR

Mercedes Benz
973 750 04 51

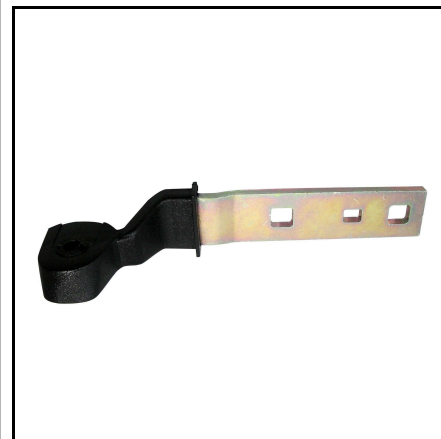

28 880 660 HOOD CATCH, LOWER

Mercedes Benz
322 880 06 60



24 545 013 IGNITION SWITCH

Mercedes Benz
667 545 00 13



24 545 508 IGNITION SWITCH

Mercedes Benz
000 545 95 08



Kabine / Cabin

25 545 108 IGNITION SWITCH

Mercedes Benz
667 545 01 08



63 450 839 JOINT BEARING

Mercedes Benz
001 981 39 31



26 310 173 LEVER, CABIN LOCKING

Mercedes Benz
970 310 01 73



14 462 327 LOCK CYLINDER

SPRINTER

Mercedes Benz
901 462 03 79



Kabine / Cabin

28 760 205 LOCKING CYLINDER WITH KEYS

Mercedes Benz
670 760 02 05



28 988 385 LOCK, BATTERY COVER

Mercedes Benz
000 988 03 85



28 750 484 LOCK, BONNET

Mercedes Benz
000 750 04 84



28 810 012 MIRROR BEARING

Mercedes Benz
641 810 00 12
641 810 01 12



Kabine / Cabin

26 810 814 MIRROR BRACKET
left

Mercedes Benz
002 810 08 14

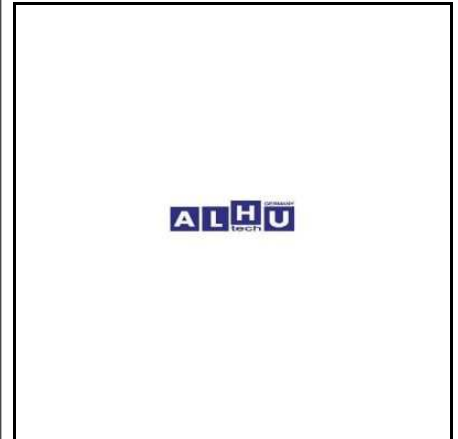

26 810 914 MIRROR BRACKET
right

Mercedes Benz
002 810 09 14

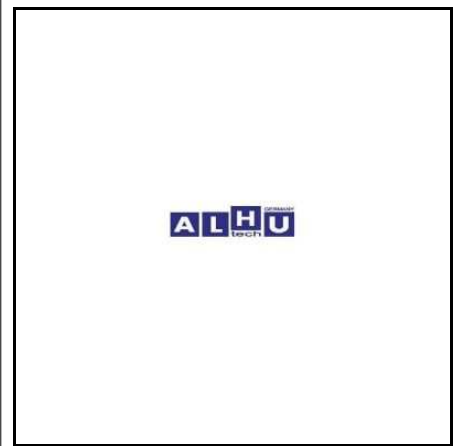

28 810 214 MIRROR BRACKET
left

Mercedes Benz
641 810 02 14

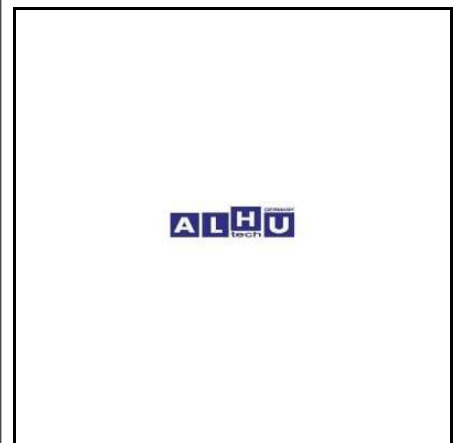

28 810 314 MIRROR BRACKET
right

Mercedes Benz
641 810 03 14

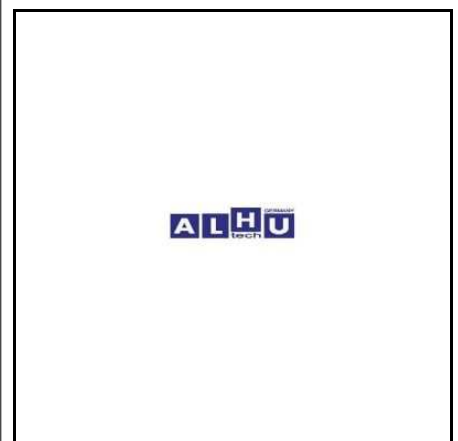

Kabine / Cabin

28 811 326 MIRROR CONSOLE

Mercedes Benz
641 811 03 26



28 811 207 MIRROR COVER

Mercedes Benz
641 811 02 07

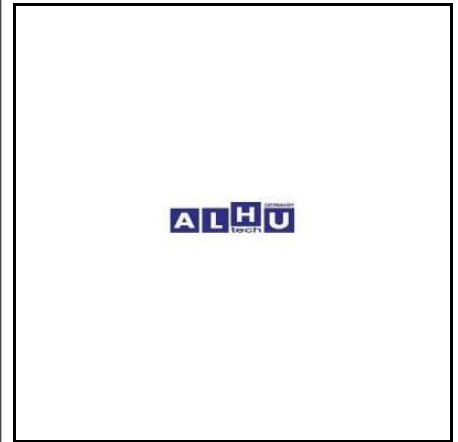

63 451 235 MIRROR COVER

Mercedes Benz
641 811 01 07



28 811 133 MIRROR GLASS

Mercedes Benz
001 811 21 33

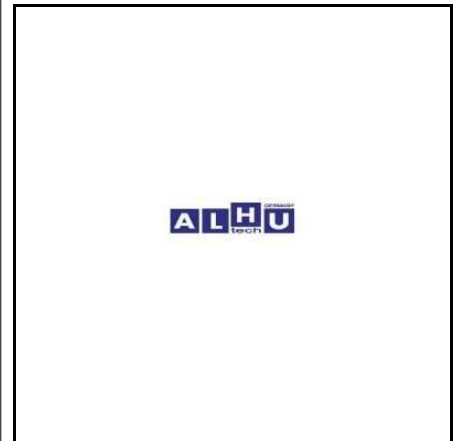

Kabine / Cabin

63 451 210 PEDAL

Mercedes Benz
615 300 01 04

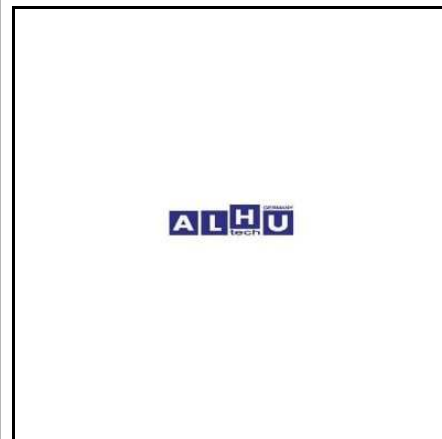

28 810 116 REARVIEW MIRROR WITH EU APPROVAL

Mercedes Benz
381 810 71 16



28 810 316 REARVIEW MIRROR WITH EU APPROVAL

Mercedes Benz
314 810 13 16

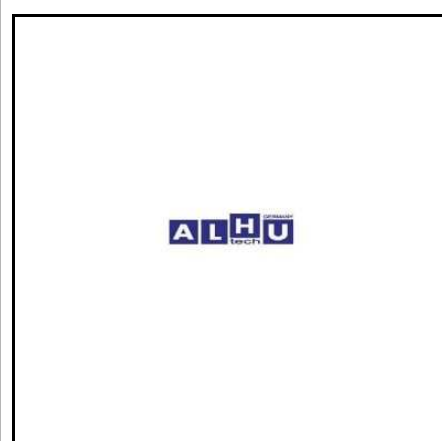

28 811 816 REARVIEW MIRROR WITH EU APPROVAL

Mercedes Benz
381 810 38 16

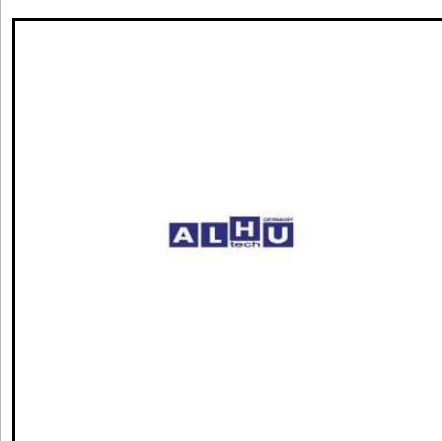

Kabine / Cabin

26 860 031 REPAIR KIT, CABIN MOUNTING

Mercedes Benz
620 586 00 31



28 310 077 REPAIR KIT, CABIN MOUNTING

Mercedes Benz
387 310 00 77



63 451 196 REPAIR KIT, CABIN MOUNTING

Mercedes Benz
381 586 00 31



63 451 215 REPAIR KIT, CABIN MOUNTING

Mercedes Benz
620 310 01 77



Kabine / Cabin

63 451 245 REPAIR KIT, CABIN MOUNTING

Mercedes Benz
655 890 29 03

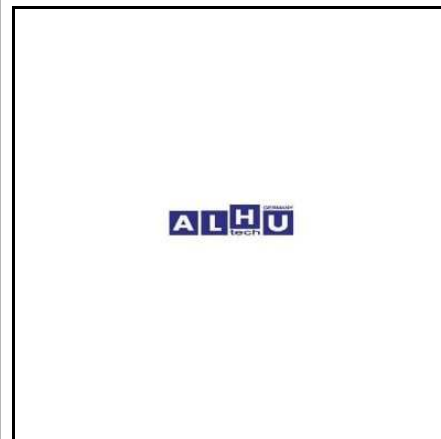

28 252 784 REVERSE LIGHT LENS

Mercedes Benz
001 544 92 90

MAN
81.25229.0784

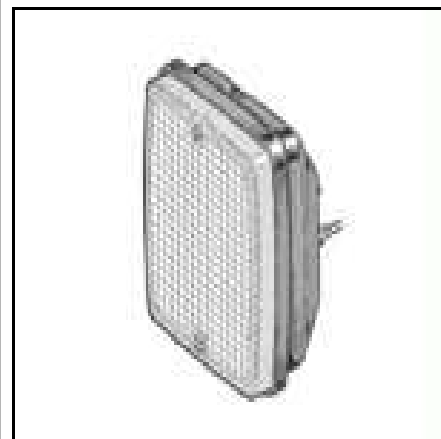

28 317 112 RUBBER BUFFER, CABIN MOUNTING FRONT

Mercedes Benz
940 317 11 12

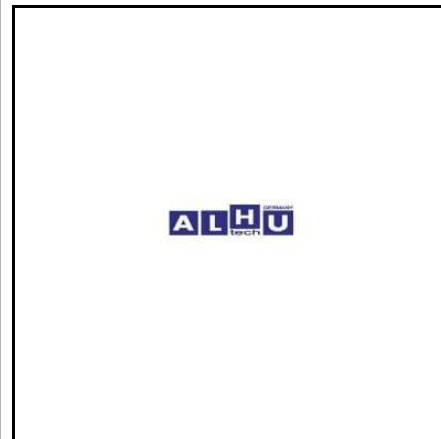

28 317 212 RUBBER BUFFER, CABIN MOUNTING FRONT

Mercedes Benz
942 317 20 12

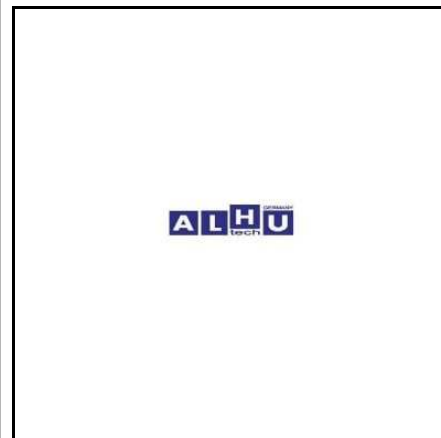

Kabine / Cabin

28 317 312 RUBBER BUFFER, CABIN MOUNTING
FRONT

Mercedes Benz
942 317 21 12

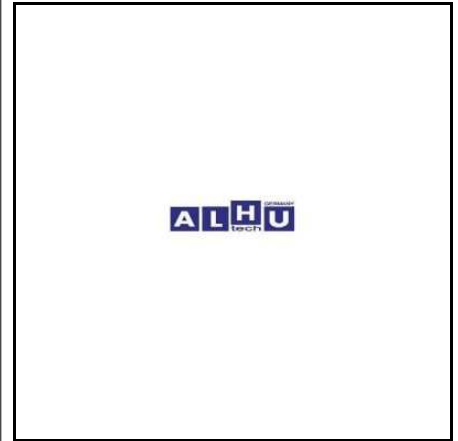

28 317 012 RUBBER BUFFER, CABIN MOUNTING,
FRONT

Mercedes Benz
940 317 10 12

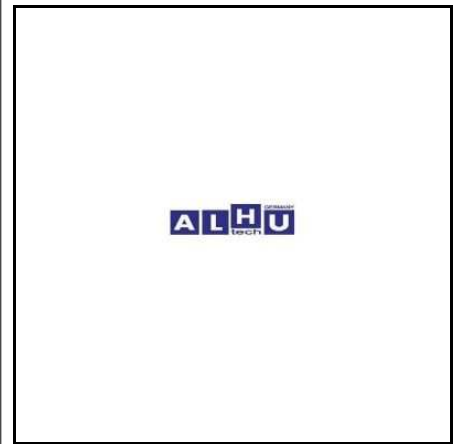

28 522 067 RUBBER FOR FENDER

ACTROS TGA TGS

Mercedes Benz
941 522 00 67

MAN
81.66410.0226

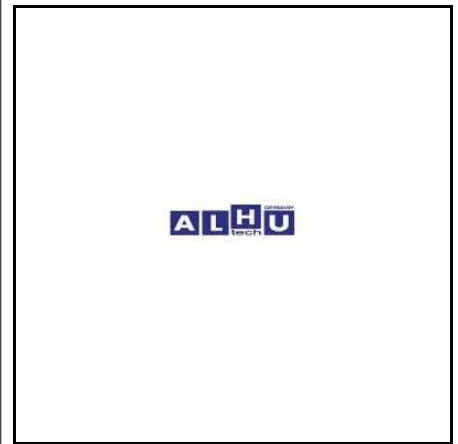

28 522 167 RUBBER FOR FENDER

Mercedes Benz
941 522 01 67

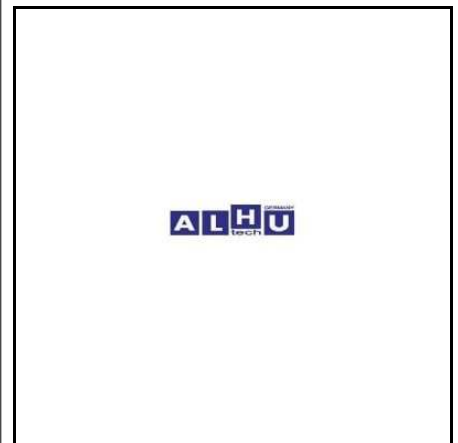

Kabine / Cabin

28 544 411 SIDE MARKER LAMP
with E mark

ACTROS

Mercedes Benz
000 544 54 11



28 760 047 SLIDING UNIT, UPPER RIGHT,

Mercedes Benz
901 760 10 47



28 760 347 SLIDING UNIT, UPPER, RIGHT

Mercedes Benz
901 760 13 47



63 450 215 SNAP LOCK

Mercedes Benz
357 750 00 50

MAN
36.97116.0000
81.97116.0099



Kabine / Cabin

24 462 130 STEERING LOCK

Mercedes Benz
001 462 11 30



26 720 079 SUPPORT

Mercedes Benz
000 720 00 79

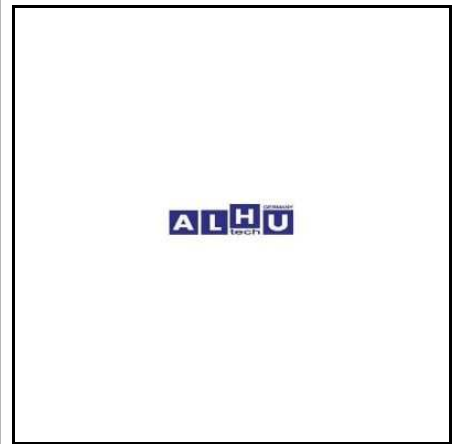

26 720 179 SUPPORT

Mercedes Benz
000 720 01 79

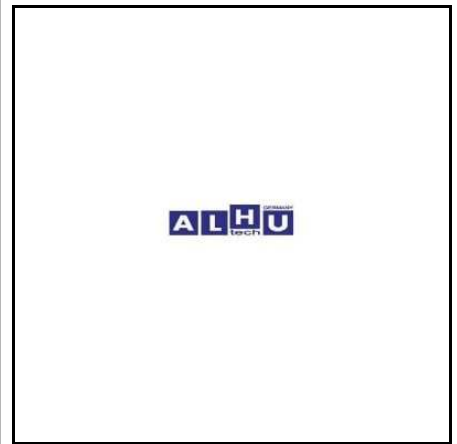

28 540 003 TAIL LAMP

Mercedes Benz
001 540 63 70

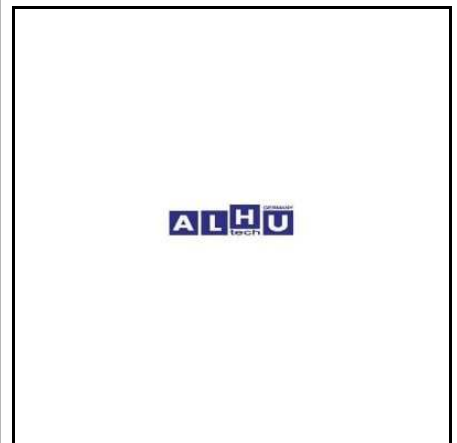

Kabine / Cabin

28 540 004 TAIL LAMP

Mercedes Benz
001 540 62 70



63 450 222 TAIL LAMP LENS

Mercedes Benz
002 544 12 90
002 544 36 90



63 450 223 TAIL LAMP LENS

Mercedes Benz
002 544 16 90



753158111 WEATHERSTRIP

ACTROS

Mercedes Benz
941 671 01 20



Kabine / Cabin

28 725 043 WINDOW HANDLE
complete

Mercedes Benz
381 725 00 60

TA501
4.90278



28 760 002 WINDOW HANDLE BLACK

Mercedes Benz
673 760 00 02



28 760 003 WINDOW HANDLE GREY

Mercedes Benz
673 760 00 02



18 720 001 WINDOW LIFTER

W 211

Mercedes Benz
211 720 03 46

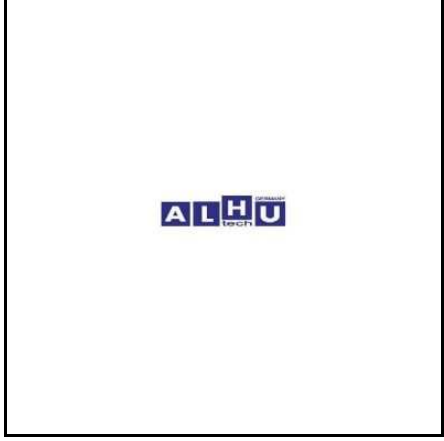

Kabine / Cabin

18 720 002 WINDOW LIFTER

W 211

Mercedes Benz
211 720 04 46

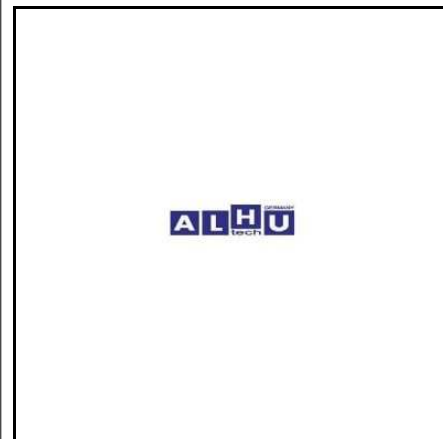

18 720 003 WINDOW LIFTER

W211

Mercedes Benz
211 730 03 46

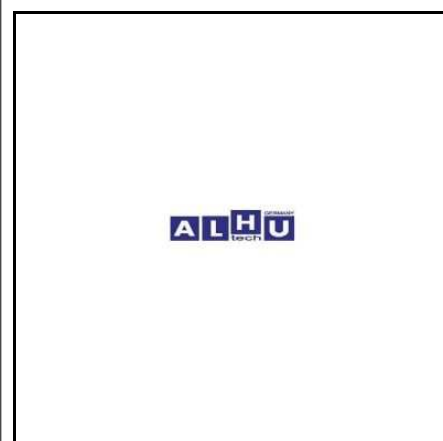

18 720 004 WINDOW LIFTER

W 211

Mercedes Benz
211 730 04 46

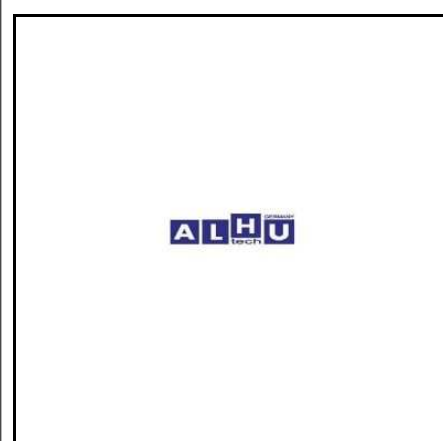

28 720 246 WINDOW LIFTER

left

Mercedes Benz
641 720 02 46

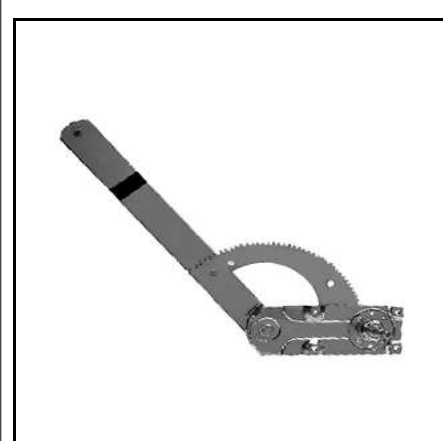

Kabine / Cabin

28 720 346 WINDOW LIFTER
right

Mercedes Benz
641 720 03 46

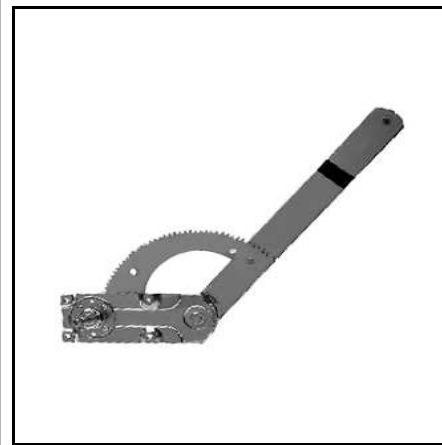

28 720 446 WINDOW LIFTER
left, manual

Mercedes Benz
901 720 14 46

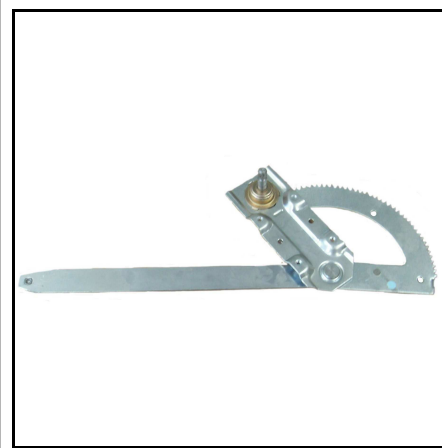

28 720 546 WINDOW LIFTER
manual, right

Mercedes Benz
901 720 15 46

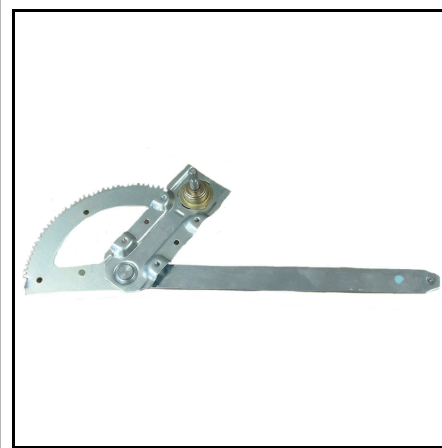

28 720 646 WINDOW LIFTER
left, manual

Mercedes Benz
941 720 04 46



Kabine / Cabin

28 720 746 WINDOW LIFTER
manual, right

Mercedes Benz
941 720 05 46



28 720 846 WINDOW LIFTER
without motor, electric , left

Mercedes Benz
000 725 00 02



28 720 946 WINDOW LIFTER
without motor,electric ,right

Mercedes Benz
000 725 01 02



28 721 246 WINDOW LIFTER
left

Mercedes Benz
000 720 02 46

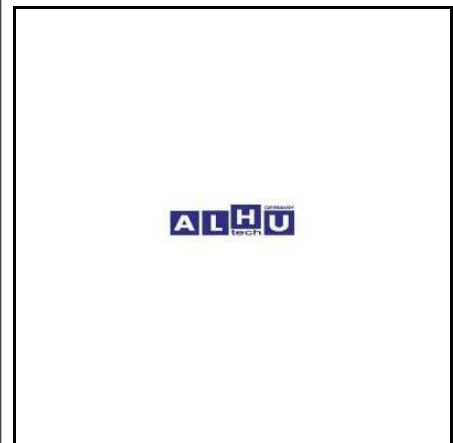

Kabine / Cabin

28 721 346 **WINDOW LIFTER**
 right

Mercedes Benz
 000 720 03 46

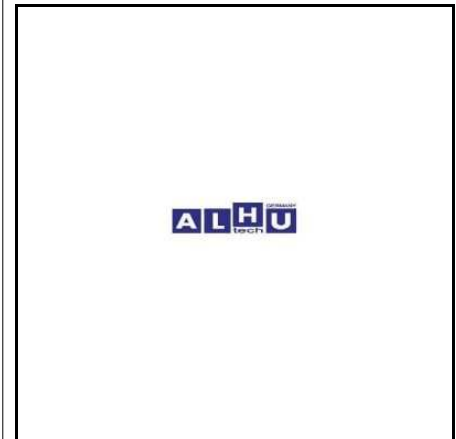

28 722 146 **WINDOW LIFTER**
 LEFT, MANUAL

ATEGO

Mercedes Benz
 973 720 01 46

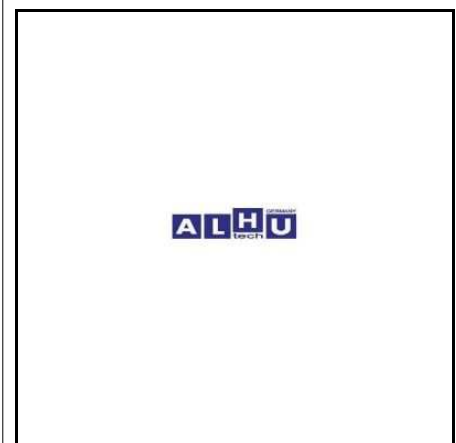

28 722 246 **WINDOW LIFTER**
 RIGHT, MANUAL

ATEGO

Mercedes Benz
 973 720 02 46

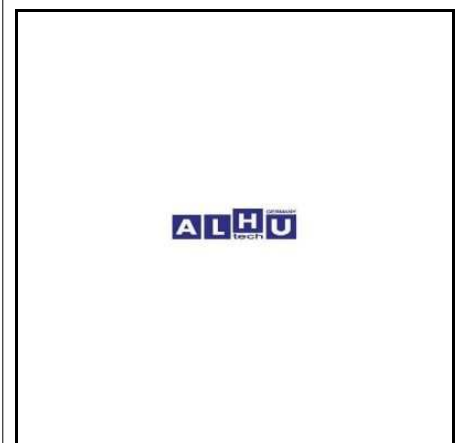

28 722 346 **WINDOW LIFTER**
 electric, left, with motor

ATEGO

Mercedes Benz
 973 720 03 46

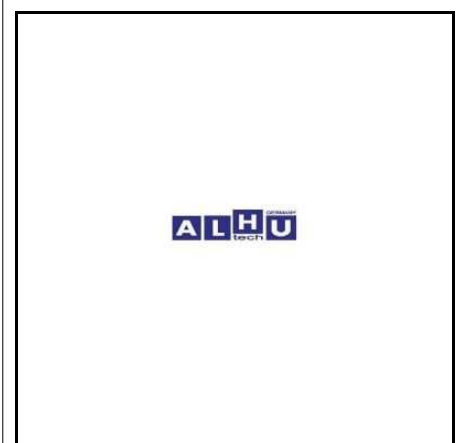

Kabine / Cabin

28 722 446 WINDOW LIFTER
electric, right
ATEGO

Mercedes Benz
973 720 04 46

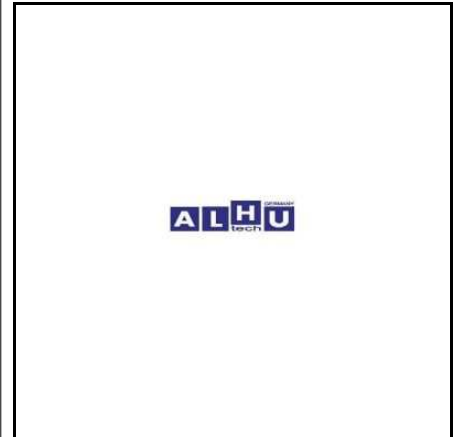

28 725 000 WINDOW LIFTER
left

Mercedes Benz
381 725 00 02

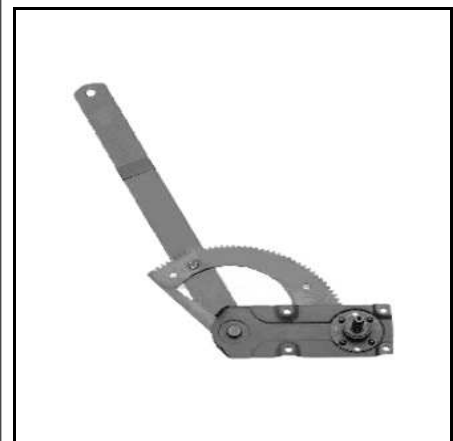

28 725 001 WINDOW LIFTER
right

Mercedes Benz
381 725 01 02



28 725 102 WINDOW LIFTER

Mercedes Benz
322 725 01 02



Kabine / Cabin

28 725 202 WINDOW LIFTER
left

Mercedes Benz
322 725 02 02

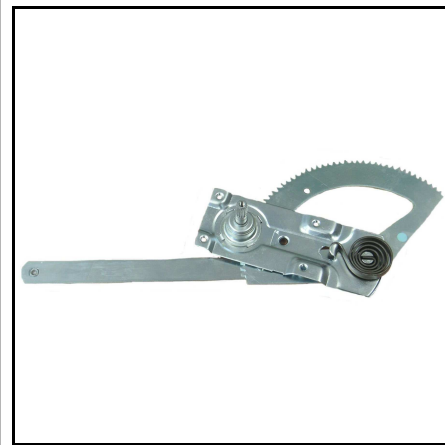

28 725 302 WINDOW LIFTER
right

Mercedes Benz
322 725 03 02

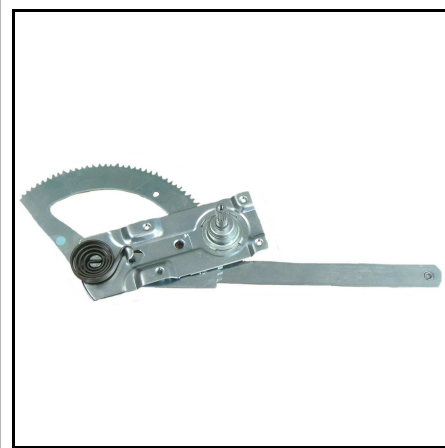

28 820 043 WINDOW LIFTER MOTOR
left

Mercedes Benz
005 820 90 42

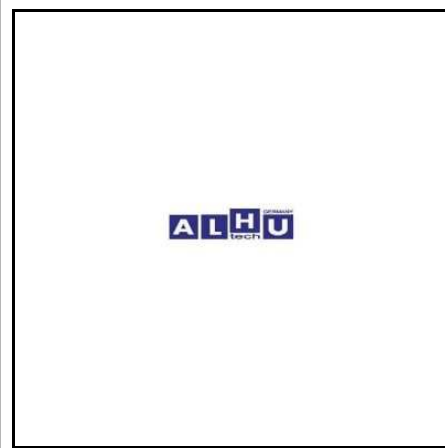

28 820 044 WINDOW LIFTER MOTOR
right

Mercedes Benz
005 820 91 42

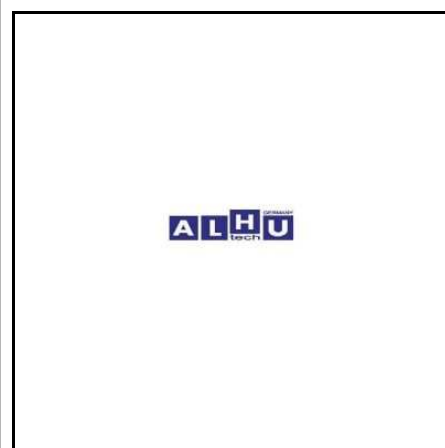

Kabine / Cabin

28 820 045 WINDOW LIFTER MOTOR

Mercedes Benz
000 820 49 08



28 820 046 WINDOW LIFTER MOTOR

Mercedes Benz
000 820 50 08



28 869 121 WINDSHIELD WASHER PUMP

Mercedes Benz
000 869 31 21



28 869 221 WINDSHIELD WASHER PUMP

Mercedes Benz 000 860 32 26	Scania 295970
MAN 81.26485.6016	VW 690 955 651



Kabine / Cabin

26 824 001 WIPER ARM

Mercedes Benz
381 824 02 28

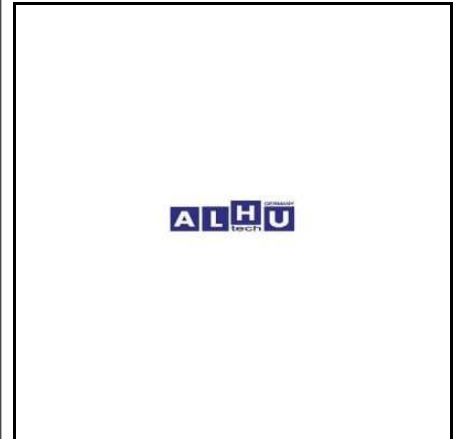

28 820 042 WIPER MOTOR

Mercedes Benz
001 824 30 01
003 820 50 42

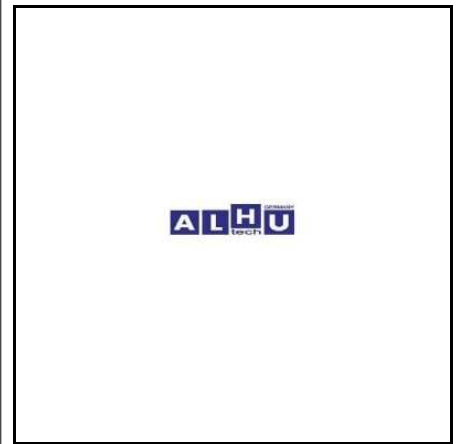

28 820 242 WIPER MOTOR

Mercedes Benz 004 820 67 42	Scania 406629
Bosch 0 390 242 404	

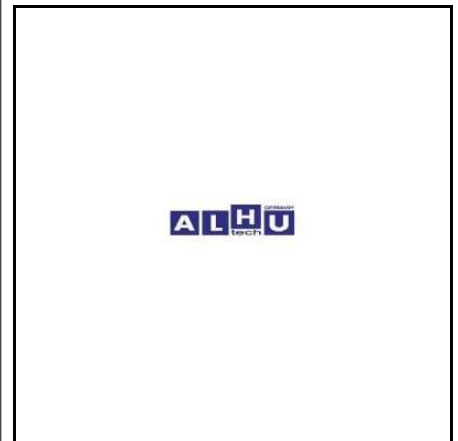

63 450 171 WIPER MOTOR

Mercedes Benz
005 820 21 42

SWF
404.233

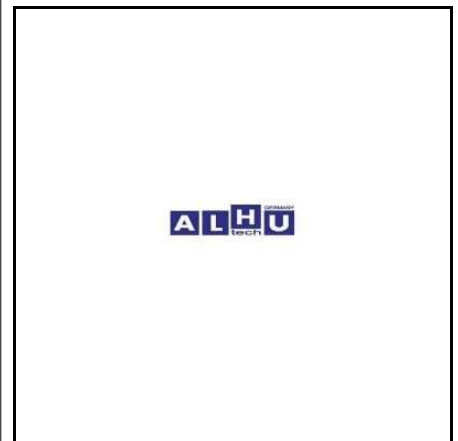

Lenkung / Steering

63 450 131 BALL JOINT

Mercedes Benz
000 460 52 48

MAN
81.95301.6288



23 333 304 CONTROL ARM

Mercedes Benz
356 333 13 04
613 333 01 04

LMI
1143001



23 350 206 CONTROL ARM

Mercedes Benz
395 350 12 06
659 350 32 06

Frimatec
114 217



23 350 908 CONTROL ARM

Mercedes Benz
948 350 24 05

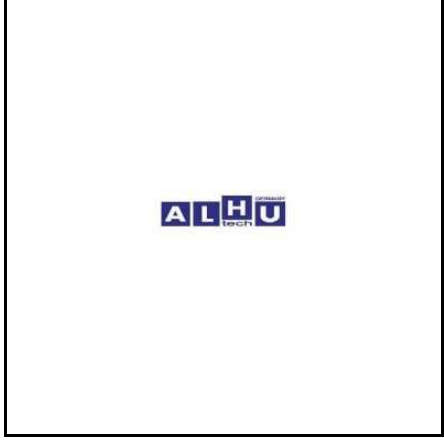

Lenkung / Steering

27 350 706 CONTROL ARM

Mercedes Benz
659 350 27 06

Frimatec
114 190

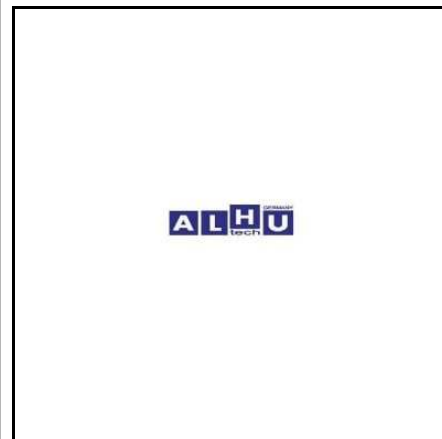

21 466 068 COVER
black

Mercedes Benz
000 466 06 68

MAN
81.47302.0011



24 460 649 DRAG LINK

Mercedes Benz
346 460 01 05

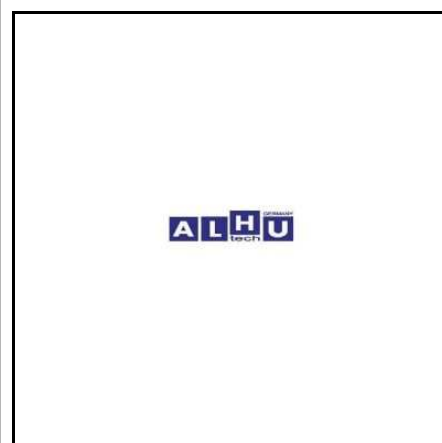

23 460 205 DRAG LINK

Mercedes Benz
002 460 61 05
002 460 62 05

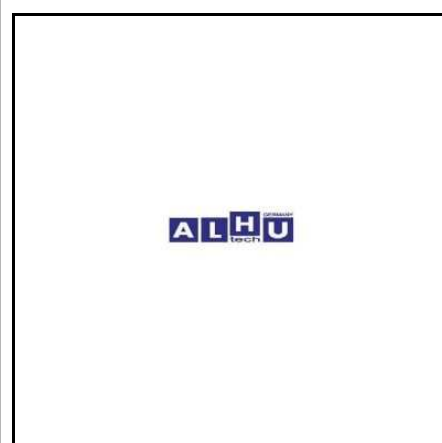

Lenkung / Steering

24 460 505 DRAG LINK

Mercedes Benz
343 460 15 05



24 460 650 DRAG LINK

Mercedes Benz
002 460 43 05
002 460 44 05



24 460 651 DRAG LINK

Mercedes Benz
000 460 71 05



63 450 556 DRAG LINK

Mercedes Benz
001 460 15 05

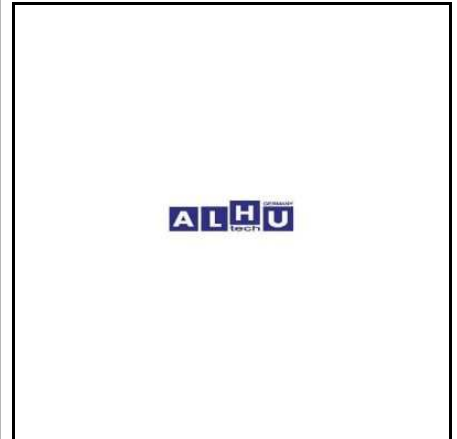

Lenkung / Steering

63 450 557 DRAG LINK



Mercedes Benz
001 460 13 05

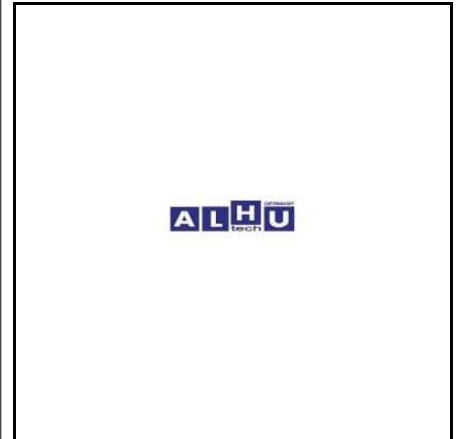

63 450 558 DRAG LINK

Mercedes Benz
001 460 71 05

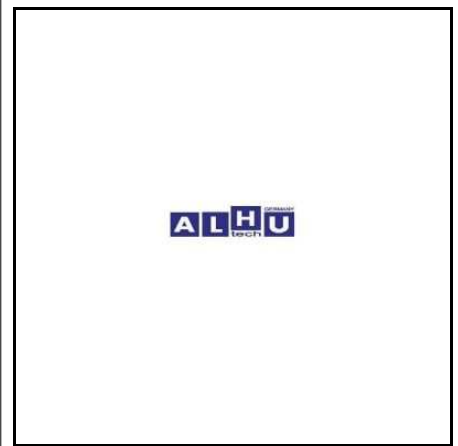

63 450 559 DRAG LINK

Mercedes Benz
001 460 11 05

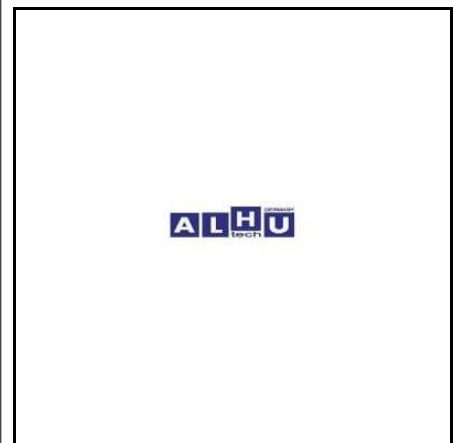

63 450 560 DRAG LINK

Mercedes Benz
949 330 04 03
949 330 23 03

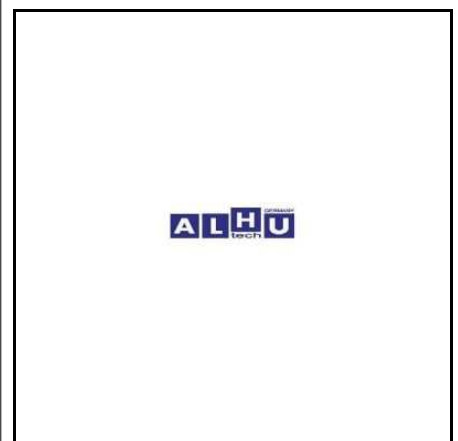

Lenkung / Steering

63 450 561 DRAG LINK

Mercedes Benz
 949 330 02 03
 949 330 09 03



63 450 562 DRAG LINK

Mercedes Benz
 944 330 02 03



63 450 834 DRAG LINK

Mercedes Benz
 387 460 14 05
 387 460 33 05
 647 460 01 05



63 450 840 DRAG LINK

Mercedes Benz
 001 460 29 05

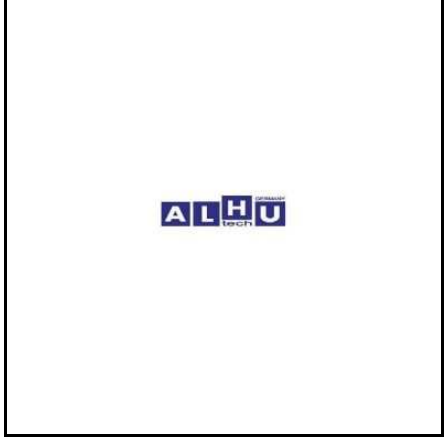

Lenkung / Steering

21 466 267 OIL DIPSTICK

Mercedes Benz
000 466 08 67

MAN
81.47303.0045



**21 460 502 OIL RESERVOIR
STEERING PUMP**

Mercedes Benz
000 466 45 02

MAN
81.47301.6030



21 463 432 STEERING DAMPER

Mercedes Benz
000 463 64 32



63 450 991 STEERING HOSE

Mercedes Benz
019 997 55 82

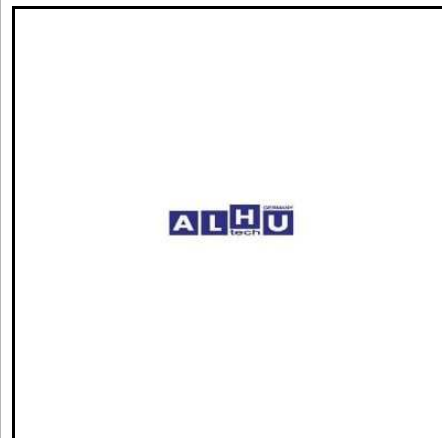

Lenkung / Steering

63 450 992 STEERING HOSE

Mercedes Benz
346 466 01 81

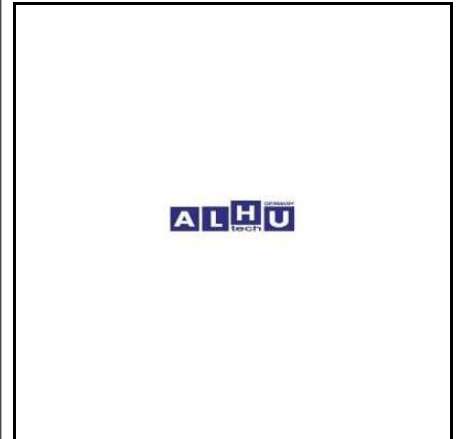

21 460 080 STEERING PUMP

Mercedes Benz
001 460 70 80

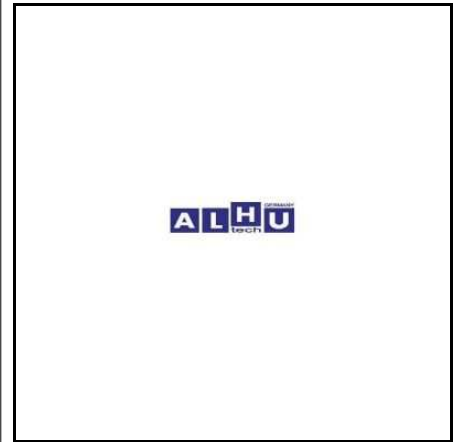

21 460 680 STEERING PUMP
ALU VERSION

Mercedes Benz
000 460 66 80

ZF
7684 955 105



21 460 701 STEERING PUMP
STEEL

Mercedes Benz
000 466 67 01

ZF
7673 955 116

MAN
81.47101.6008



Lenkung / Steering

21 460 880 STEERING PUMP

ACTROS

Mercedes Benz
003 460 50 80

ZF
7685 955 252



23 330 003 TIE ROD

Mercedes Benz
941 330 01 03
941 330 02 03

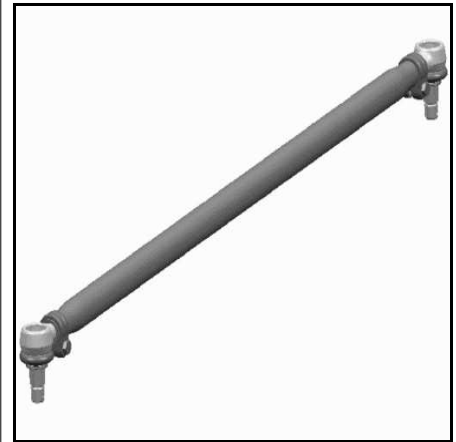

23 330 303 TIE ROD

Mercedes Benz
945 330 02 03

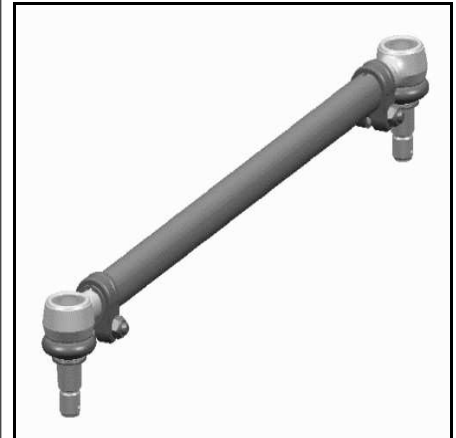

23 330 035 TIE ROD END

Mercedes Benz
001 330 01 35

LMI
1140202

DAF
1229944

MAN
81.95301.6239
81.95301.6272

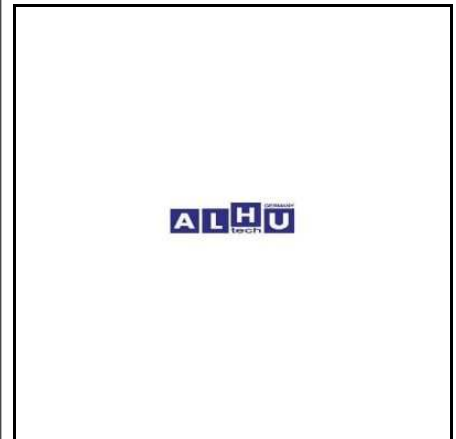

Lenkung / Steering

23 330 135 TIE ROD END

RH

Mercedes Benz

001 330 21 35



23 460 048 TIE ROD END

Mercedes Benz

001 460 05 48

001 460 79 48

LMI

1228003



23 460 148 TIE ROD END

Mercedes Benz

000 460 68 48

001 460 17 48

001 460 96 48

LMI

1139403

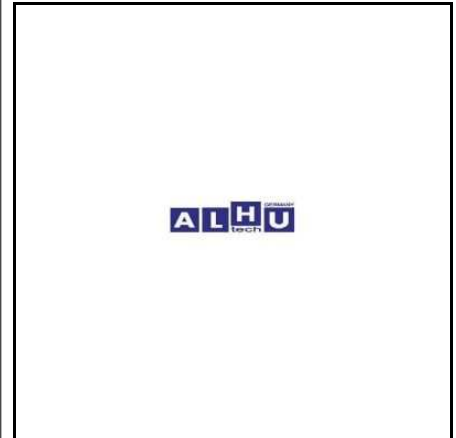

23 460 248 TIE ROD END

RH

Mercedes Benz

001 460 22 48

MAN

81.95301.6234

81.95301.6274

81.95301.6308

LMI

1150503

Scania

1358793



Lenkung / Steering

23 460 448 TIE ROD END	
LH	
Mercedes Benz 001 460 14 48	Iveco 4802444
DAF 690225	LMI 1149203
weitere/another	



Motor / Engine

21 300 030 ACCELERATION CABLE

Mercedes Benz
901 300 10 30

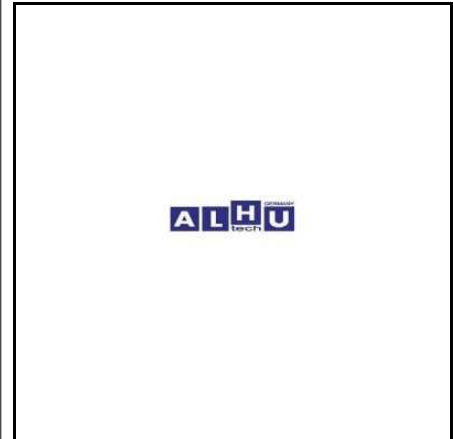

21 301 030 ACCELERATION CABLE

Mercedes Benz
901 300 16 30
901 300 17 30

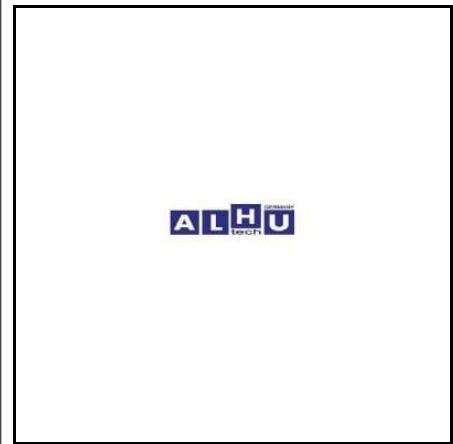

21 300 304 ACCELERATOR PEDAL KIT

Mercedes Benz
624 300 03 04



28 055 001 ADJUSTING SCREW

Mercedes Benz
442 055 00 20

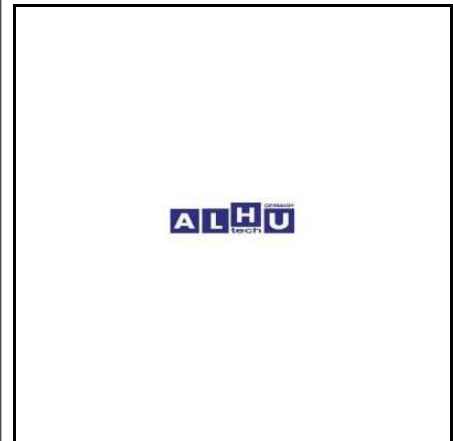

Motor / Engine

21 094 702 AIR CLEANER

Mercedes Benz
016 094 57 02



21 094 202 AIR CLEANER, oil bath

Mercedes Benz
010 094 12 02



21 130 820 AIR COMPRESSOR VALVE PLATE KIT

Mercedes Benz
541 130 08 20



21 130 920 AIR COMPRESSOR VALVE PLATE KIT
with gasket

Mercedes Benz
000 130 76 20

Wabco
411.033.922.2

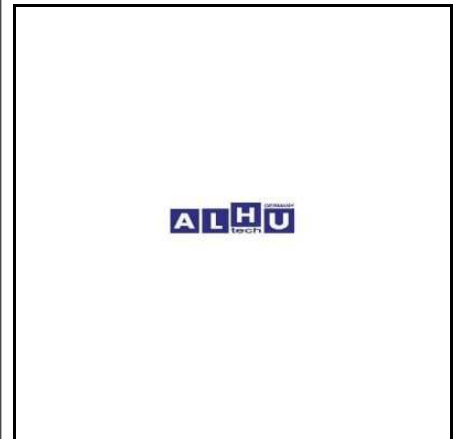

Motor / Engine

21 072 112 AIR CYLINDER

Mercedes Benz 000 072 01 12	MAN 81.11701.6046
KNORR I58893	



21 072 812 AIR CYLINDER

Mercedes Benz 000 072 18 12	
KNORR SZ1159	



21 430 826 AIR CYLINDER

Mercedes Benz 000 430 49 26	MAN 88.15701.6003
KNORR I90948	



24 430 026 AIR CYLINDER

Mercedes Benz 000 430 60 26	
KNORR I94326	



Motor / Engine

21 200 070 BELT TENSIONER
with plastic pulley
ACTROS

Mercedes Benz
541 200 18 70

LMI
2288701

TA501
T 3048



21 200 170 BELT TENSIONER
with metal pulley

Mercedes Benz
541 200 11 70

LMI
2288801

TA501
T3049



21 200 470 BELT TENSIONER
ATEGO

Mercedes Benz
906 200 20 70

TA501
APV1055

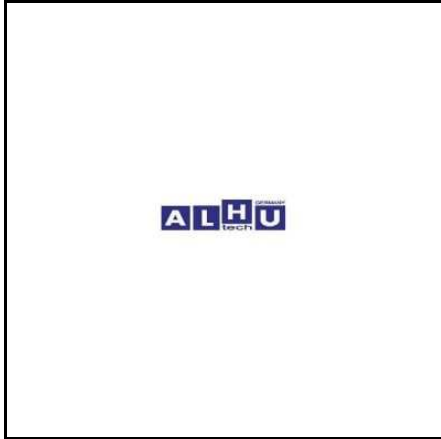

21 200 570 BELT TENSIONER
AXOR

Mercedes Benz
457 200 14 70
457 200 22 70



Motor / Engine

21 200 571 BELT TENSIONER

AXOR

Mercedes Benz
000 200 15 70



21 200 572 BELT TENSIONER

TRAVEGO

Mercedes Benz
457 200 16 70

Dayco
APV1094



21 200 573 BELT TENSIONER

Mercedes Benz
457 200 31 70



21 200 574 BELT TENSIONER

Mercedes Benz
906 200 12 70



Motor / Engine

21 200 575 BELT TENSIONER

Mercedes Benz
906 200 22 70

TA501
APV1107

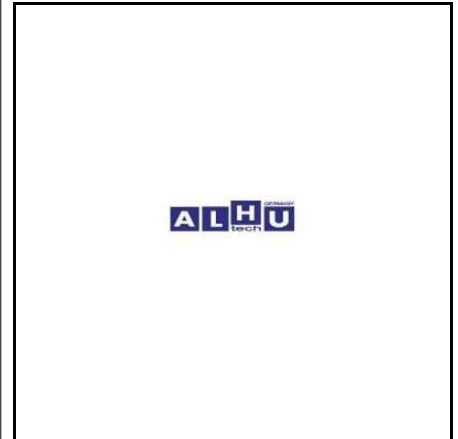

21 200 579 BELT TENSIONER

Mercedes Benz
541 200 15 70

Dayco
APV1097

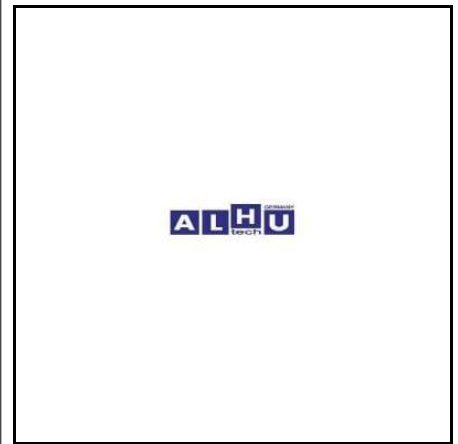

21 200 582 BELT TENSIONER

Mercedes Benz
906 200 18 70

Dayco
APV1105



21 200 590 BELT TENSIONER

Mercedes Benz
541 200 23 70

Dayco
APV1098

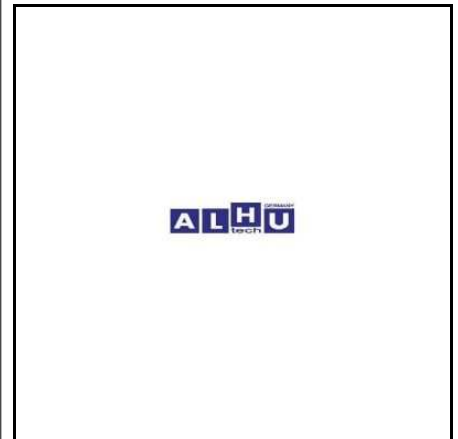

Motor / Engine

21 200 591 BELT TENSIONER

Mercedes Benz

457 200 17 70
457 200 34 70

Dayco

APV1095

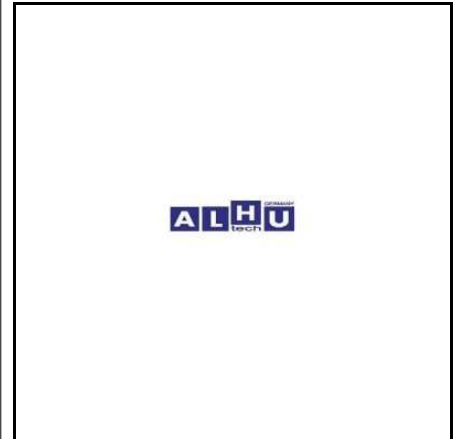

21 200 670 BELT TENSIONER

Mercedes Benz

457 200 21 70

TA501

APV2451



21 200 972 BELT TENSIONER

AXOR ATEGO

Mercedes Benz

906 200 59 70

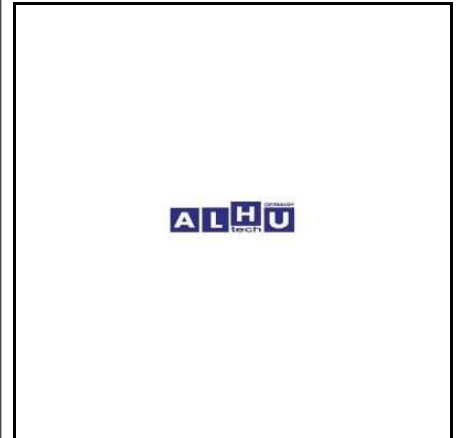

21 200 033 BELT TENSIONER PULLEY

Mercedes Benz

000 550 00 33

Dayco

APV2410

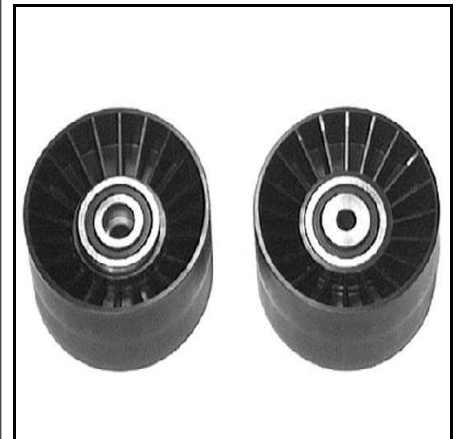

Motor / Engine

21 200 433 BELT TENSIONER PULLEY

Mercedes Benz
000 550 04 33



21 200 586 BELT TENSIONER PULLEY

Mercedes Benz
000 550 06 33

Dayco
APV2409

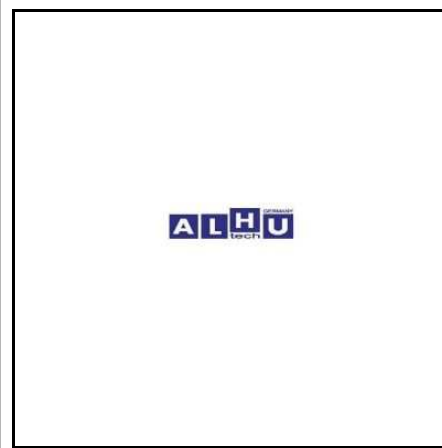

21 200 971 BELT TENSIONER PULLEY

Mercedes Benz
906 200 44 70



21 201 770 BELT TENSIONER PULLEY

Mercedes Benz
442 200 07 70

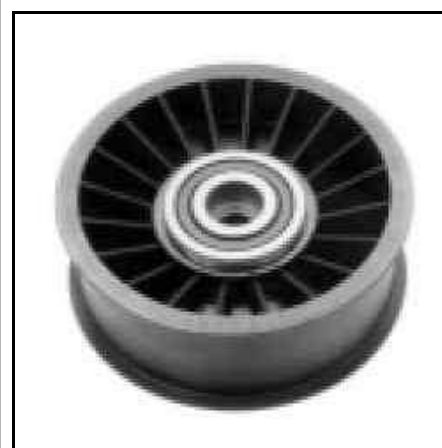

Motor / Engine

21 600 315 BELT TENSIONER PULLEY
plastic

Mercedes Benz
000 550 16 33

Dayco
APV2456



21 070 009 BOOSTER CYLINDER

Mercedes Benz
000 072 29 12

MAN
51.11160.6009

Bosch
0 482 020 003



18 010 001 BREATHER PIPE

Mercedes Benz
601 010 04 70



63 451 185 BUSHING

Mercedes Benz
352 155 06 50



Motor / Engine

63 451 410 CLAMP



Mercedes Benz
002 997 97 90

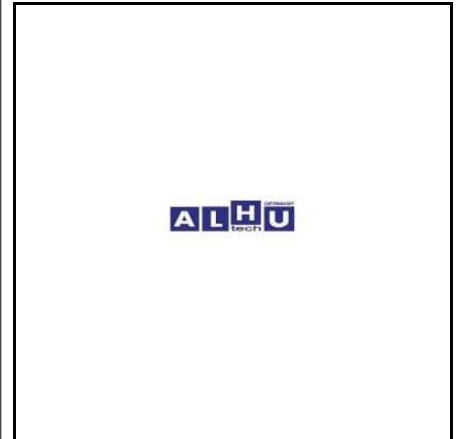

63 451 411 CLAMP



Mercedes Benz
005 997 06 90

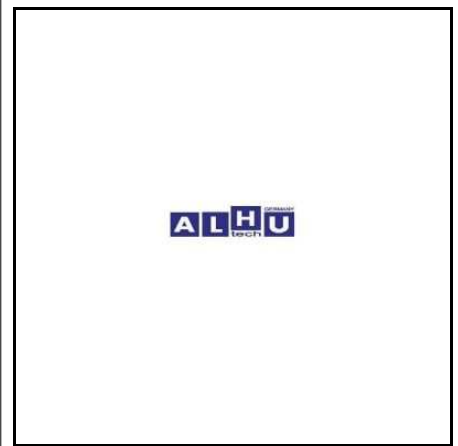

28 094 255 CLIP, AIR FILTER

Mercedes Benz
000 094 12 55

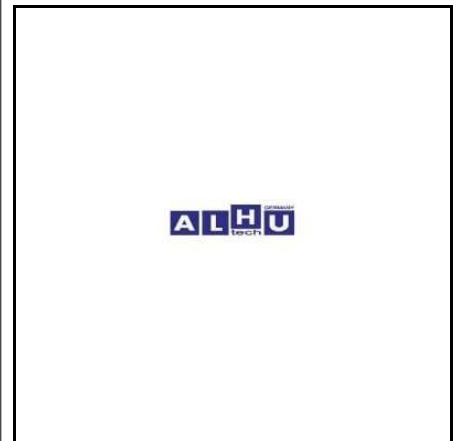

28 077 325 CLUTCH DISC

Mercedes Benz 000 077 04 25	MAN 88.11308.0202
Bosch 3 411 190 503	

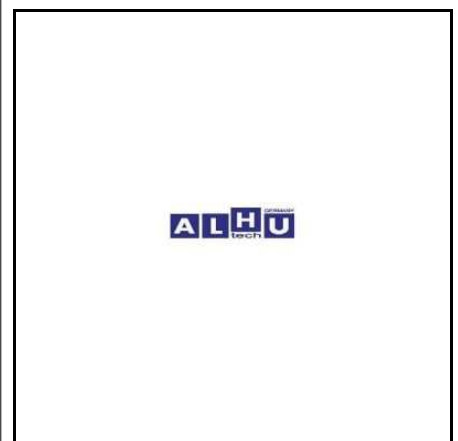

Motor / Engine

21 230 311 COMPRESSOR

air conditioning

Mercedes Benz

541 230 13 11

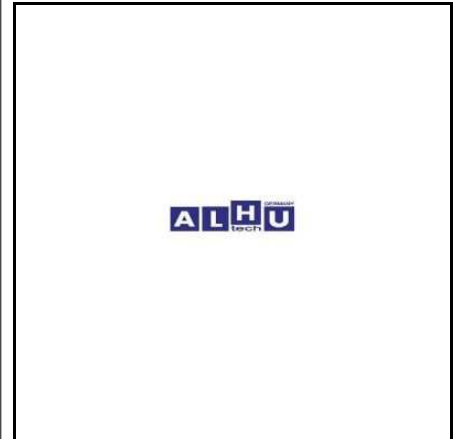

21 230 611 COMPRESSOR

air conditioning

Mercedes Benz

541 230 12 11

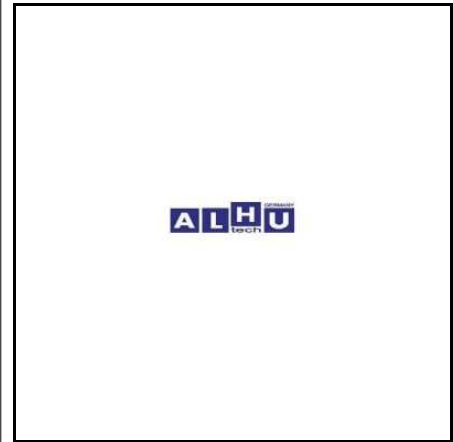

21 203 026 COMPRESSOR HOSE

Mercedes Benz

002 997 92 82

MAN

51.10302.6025

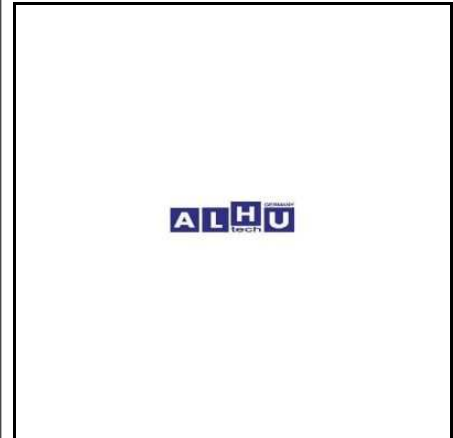

11 831 770 CONDENSOR

SPRINTER

Mercedes Benz

901 500 05 54

Behr/Hella

8FC 351 037-161



Motor / Engine

21 830 054 CONDENSOR

SPRINTER

Mercedes Benz
906 500 00 54

Behr/Hella
8FC 351 307-641

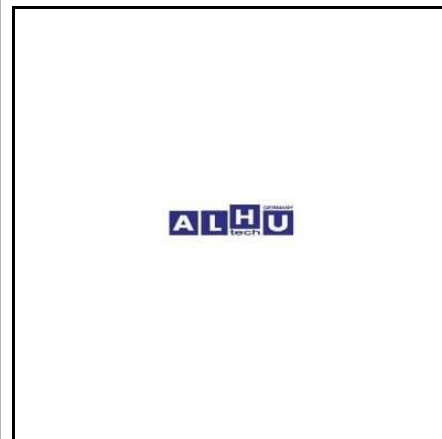

21 830 154 CONDENSOR

ACTROS

Mercedes Benz
942 500 00 54
942 500 01 54

Behr/Hella
8FC 351 300-131

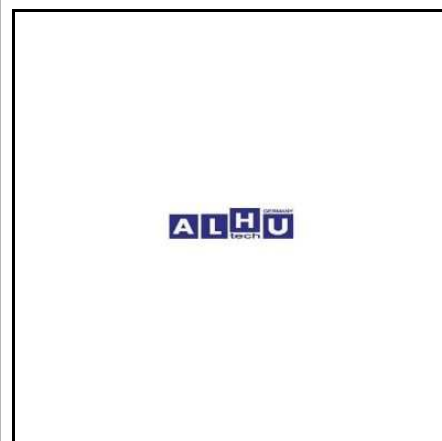

21 528 082 CONNECTION HOSE

Mercedes Benz
615 528 00 82

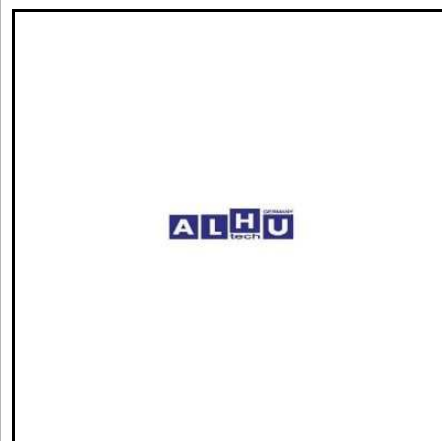

21 030 020 CONROD

Mercedes Benz
422 030 04 20



Motor / Engine

21 030 021 CONROD

Mercedes Benz
906 030 02 20



21 030 120 CONROD

D 2566/2866 and OM

Mercedes Benz
407 030 07 20

MAN
51.02401.6214



21 030 121 CONROD

Mercedes Benz
906 030 03 20



21 030 220 CONROD

Mercedes Benz
442 030 02 20

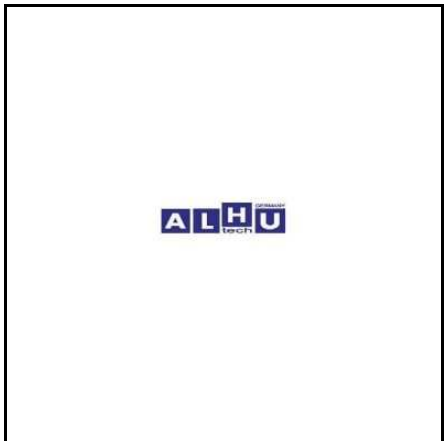

Motor / Engine

21 030 320 CONROD

Mercedes Benz
447 030 03 20



21 030 420 CONROD

Mercedes Benz
447 030 04 20



21 030 620 CONROD

OM 407/409

Mercedes Benz
407 030 06 20



21 030 720 CONROD

OM 401/441

Mercedes Benz
441 030 08 20

MAN
51.02401.6239

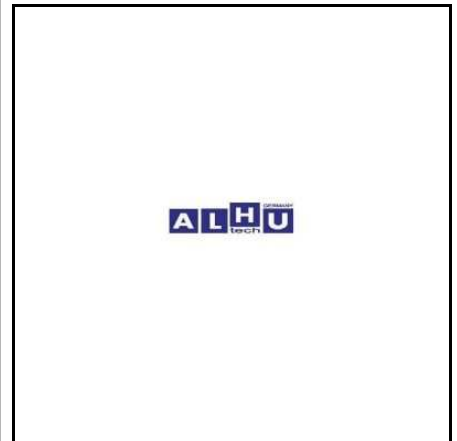

Motor / Engine

21 030 820 CONROD

Mercedes Benz
541 030 05 20



21 030 920 CONROD

Mercedes Benz
542 030 05 20



21 031 320 CONROD

Mercedes Benz
904 030 03 20



63 451 407 COVER



Mercedes Benz
000 011 00 21



Motor / Engine

21 184 028 COVER, OIL FILTER

Mercedes Benz
541 184 02 08



21 030 022 CRANKSHAFT

Mercedes Benz
402 030 30 01



21 030 023 CRANKSHAFT

Mercedes Benz
422 030 37 01



21 050 303 CRANKSHAFT GEAR

Mercedes Benz
403 050 03 03



Motor / Engine

63 450 573 CRANKSHAFT GEAR

Mercedes Benz
906 052 14 03

Volvo
1080690

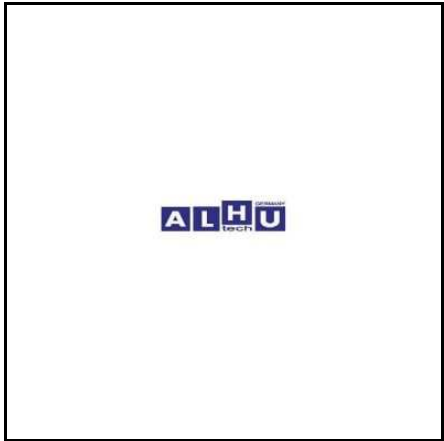

21 031 027 CRANKSHAFT RACE

Mercedes Benz
442 031 00 27



21 032 309 CRANKSHAFT RACE

Mercedes Benz
403 032 03 09

MAN
51.02130.0013



26 010 130 CYLINDER HEAD COVER

Mercedes Benz
457 010 01 30

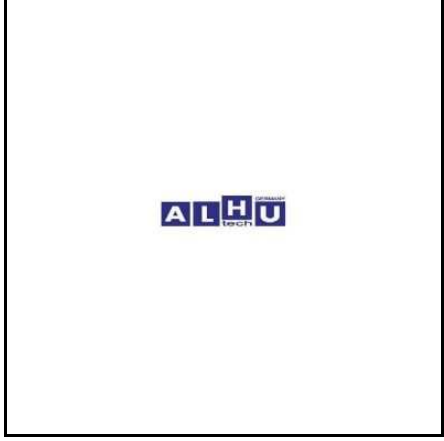

Motor / Engine

28 018 333 DIAPHRAGM KIT

Mercedes Benz
541 018 03 33

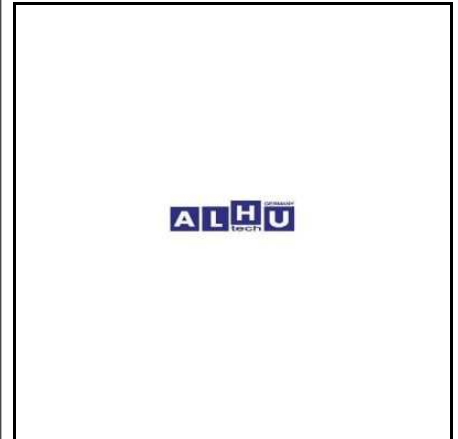

21 098 183 DISCHARGE HOSE

Mercedes Benz
366 098 01 83

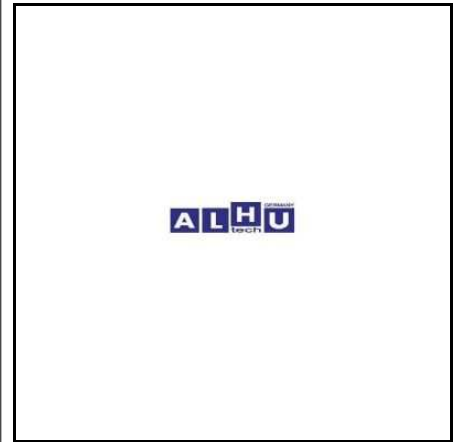

63 450 096 DRIVE GEAR

Mercedes Benz
403 077 07 12

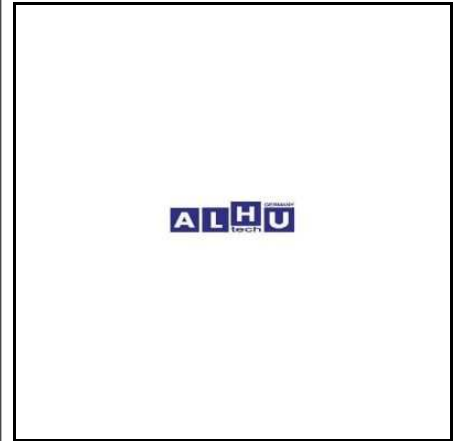

63 450 638 DRIVING DOG

Mercedes Benz
000 132 07 10

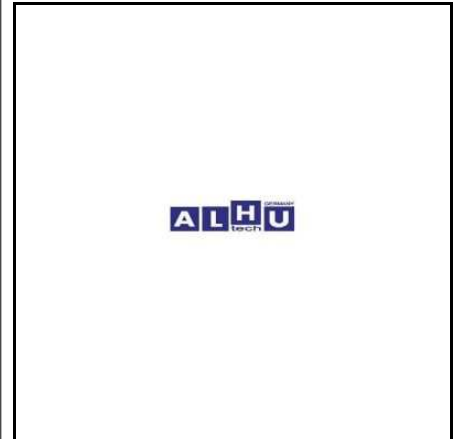

Motor / Engine

28 240 001 ENGINE MOUNTING

Mercedes Benz
307 240 00 17

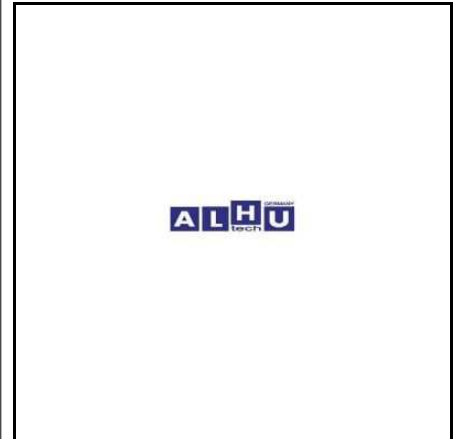

63 451 209 EXHAUST BOLT

Mercedes Benz
457 990 20 01

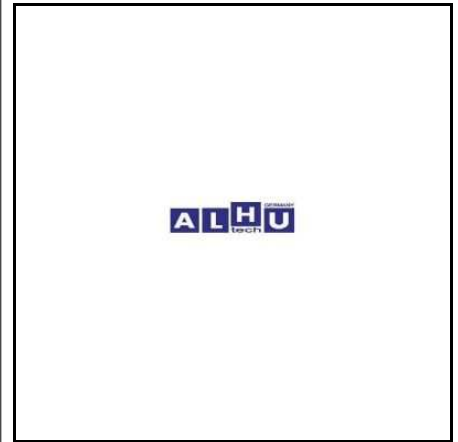

63 451 408 EXHAUST BRAKE FLAP



Mercedes Benz
442 140 49 53

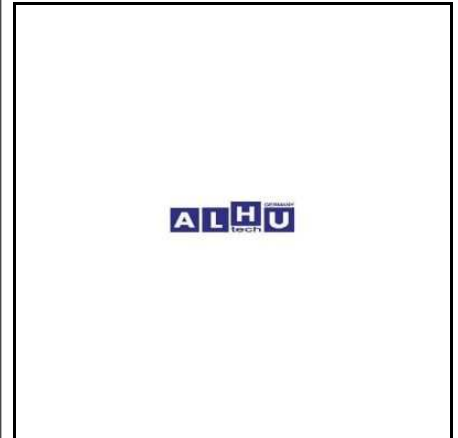

24 997 073 EXHAUST CLAMP

Mercedes Benz
071 555 11 05 01

MAN
81.97420.0073

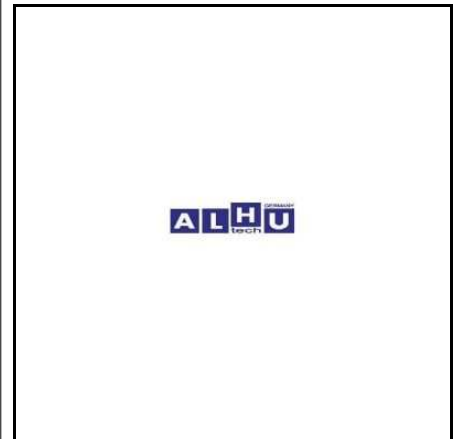

Motor / Engine

24 997 085 EXHAUST CLAMP

Mercedes Benz
071 555 11 45 00

MAN
81.97420.0085
81.97420.0139



28 490 001 EXHAUST CLAMP

Mercedes Benz
387 490 00 41



63 451 310 EXHAUST CLAMP

Mercedes Benz
942 490 00 41



63 451 311 EXHAUST CLAMP

Mercedes Benz
942 490 01 41



Motor / Engine

63 451 315 EXHAUST CLAMP

Mercedes Benz
942 997 00 90



63 451 316 EXHAUST CLAMP

Mercedes Benz
942 997 02 90



24 997 590 EXHAUST CLAMP 75 MM
for 620 490 0365

Mercedes Benz
620 997 04 90



24 997 690 EXHAUST CLAMP 90 MM
for 620 490 0465

Mercedes Benz
620 997 05 90



Motor / Engine

24 997 790 EXHAUST CLAMP 100 MM

for 621 490 0065

Mercedes Benz

621 997 00 90



24 492 008 EXHAUST CONNECTING PIECE

Mercedes Benz

621 492 00 08



24 492 018 EXHAUST CONNECTING PIECE

Mercedes Benz

617 492 00 08



24 492 208 EXHAUST CONNECTING PIECE

Mercedes Benz

620 492 02 08



Motor / Engine

28 490 002 EXHAUST CONNECTOR

Mercedes Benz
387 490 06 25



21 490 065 EXHAUST FLEX METAL TUBE

Mercedes Benz
673 490 00 65



21 490 165 EXHAUST FLEX METAL TUBE

Mercedes Benz
673 490 02 65



21 490 819 EXHAUST FLEX METAL TUBE

Mercedes Benz
942 490 28 19



Motor / Engine

21 490 565 EXHAUST FLEX METAL TUBE 113 MM

Mercedes Benz
621 490 00 65



21 491 050 EXHAUST MANIFOLD

Mercedes Benz
541 140 21 03

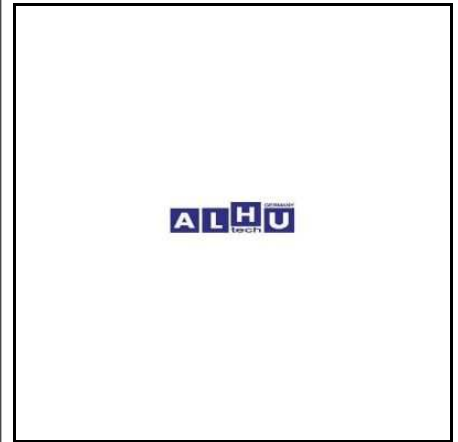

21 491 051 EXHAUST MANIFOLD

Mercedes Benz
541 140 22 03

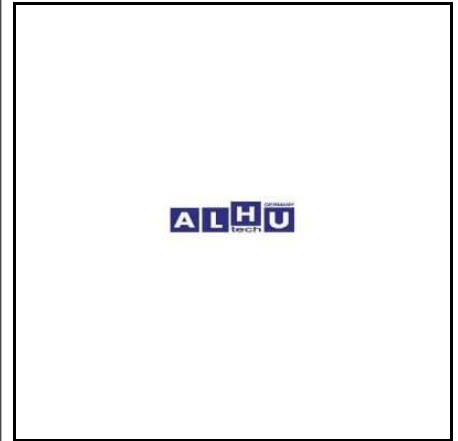

21 491 052 EXHAUST MANIFOLD

Mercedes Benz
541 140 25 03

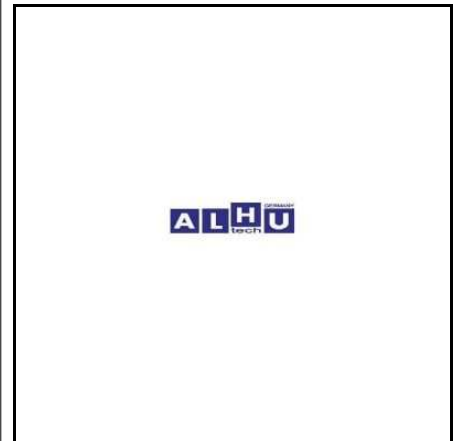

Motor / Engine

21 491 053 EXHAUST MANIFOLD

Mercedes Benz
541 140 26 03

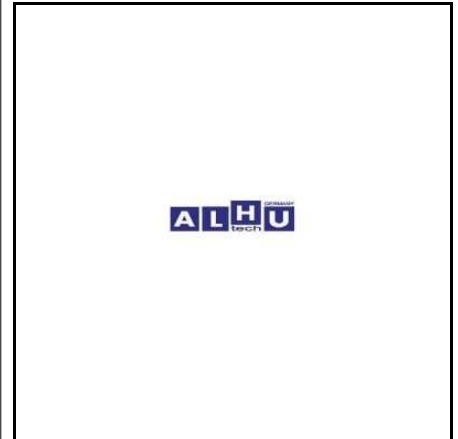

63 453 005 EXHAUST MANIFOLD GASKET

Mercedes Benz
541 142 01 80

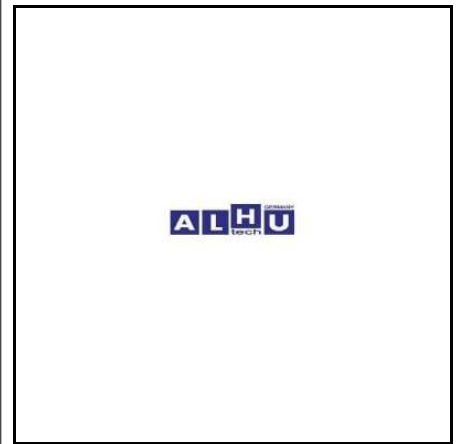

21 490 365 EXHAUST METAL HOSE

90 mm

Mercedes Benz
620 490 03 65



21 490 465 EXHAUST METAL HOSE

10 mm

Mercedes Benz
620 490 04 65



Motor / Engine

21 490 665 EXHAUST METAL HOSE

Mercedes Benz
674 490 00 65



21 490 019 EXHAUST PIPE

Mercedes Benz
942 490 30 19



21 490 119 EXHAUST PIPE

Mercedes Benz
942 490 31 19



21 490 219 EXHAUST PIPE

Mercedes Benz
942 490 20 19



Motor / Engine

21 490 319 EXHAUST PIPE

Mercedes Benz
942 490 36 19

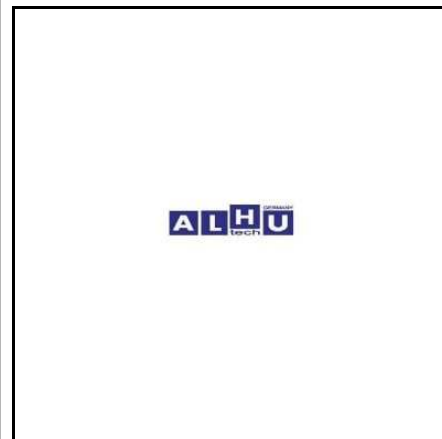

21 490 765 EXHAUST PIPE

Mercedes Benz
942 490 22 19

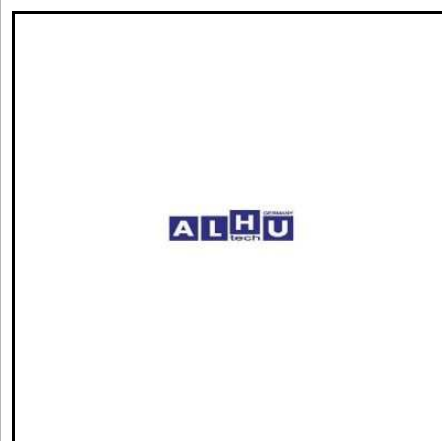

21 500 049 EXPANSION TANK

Mercedes Benz
000 500 30 49

TA501
8MA 376 705-081

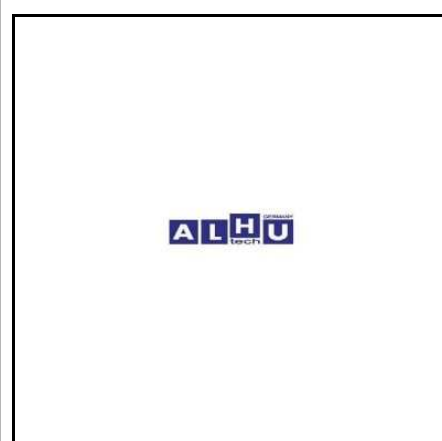

21 500 050 EXPANSION TANK

Mercedes Benz
627 500 00 49

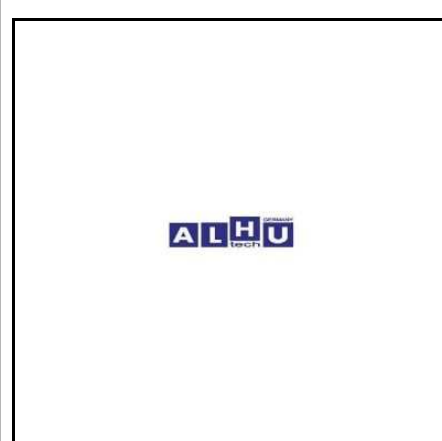

Motor / Engine

21 500 149 EXPANSION TANK

SK

Mercedes Benz
000 500 31 49



21 500 849 EXPANSION TANK

AXOR

Mercedes Benz
940 501 00 03



63 451 434 EXPANSION TANK



Mercedes Benz
674 500 00 49



63 451 436 EXPANSION TANK



Mercedes Benz
000 500 21 49



Motor / Engine

63 451 437 EXPANSION TANK



Mercedes Benz
000 500 22 49

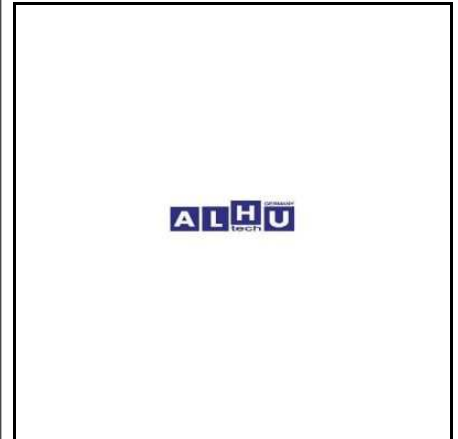

63 451 441 EXPANSION TANK



Mercedes Benz
970 500 04 49

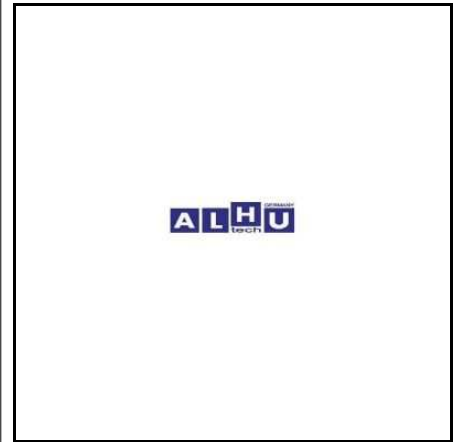

21 205 006 FAN BLADE

SK/POWERLINER

Mercedes Benz
003 205 00 06

Scania
1354070

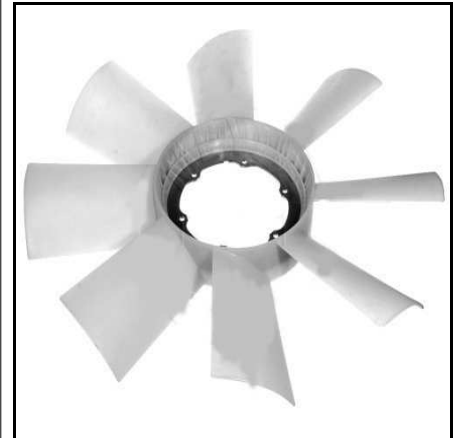

21 205 007 FAN BLADE

Mercedes Benz
003 205 06 06

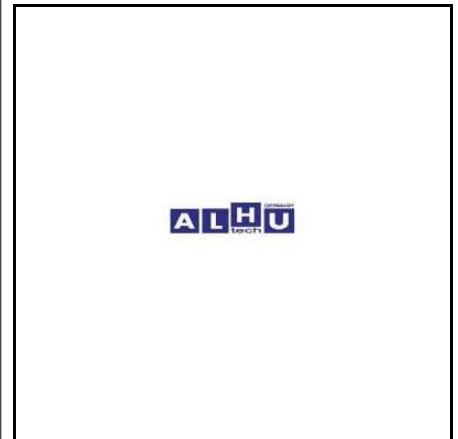

Motor / Engine

21 205 008 FAN BLADE

Mercedes Benz

906 205 04 06
906 205 09 06

Behr/Hella

8MV 376 733-181

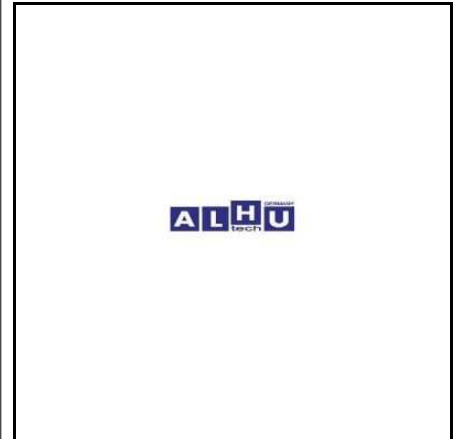

21 205 009 FAN BLADE

Mercedes Benz

003 205 36 06

Behr/Hella

8MV 376 733-261

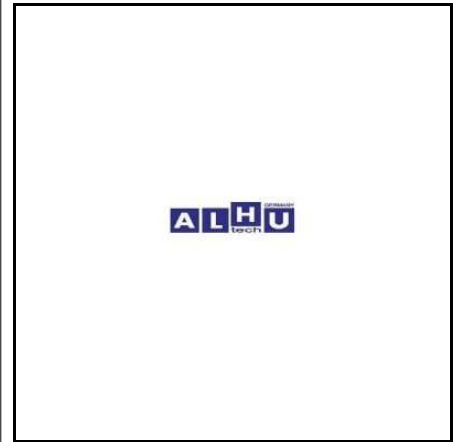

21 205 046 FAN BLADE

8 blades

Mercedes Benz

904 205 04 06



21 205 106 FAN BLADE

ACTROS

Mercedes Benz

003 205 01 06

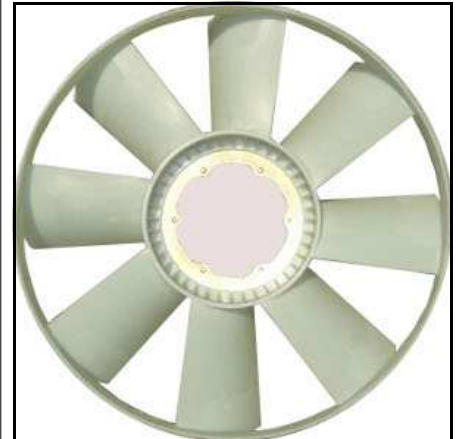

Motor / Engine

21 205 206 FAN BLADE

Mercedes Benz
003 205 42 06

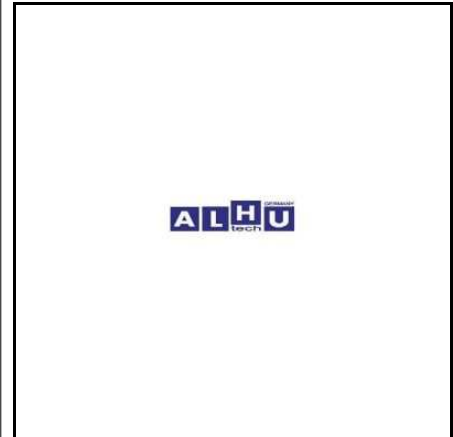

21 205 506 FAN BLADE
metal

Mercedes Benz
002 205 70 06

Behr/Hella
8MV 376 727-051

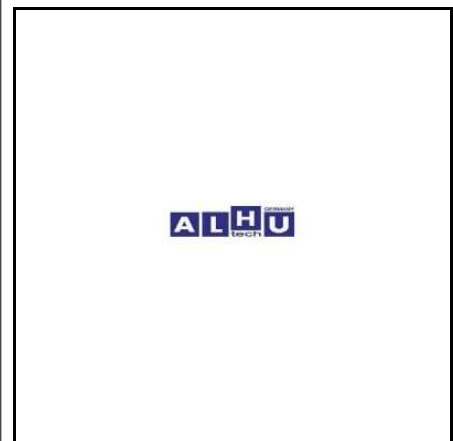

21 205 606 FAN BLADE

Mercedes Benz
002 205 93 06

Behr/Hella
8MV 376 733-121

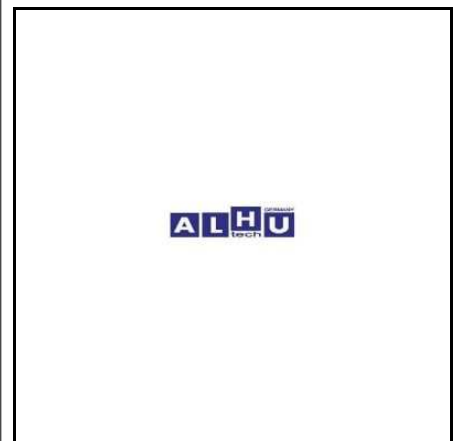

21 500 364 FAN BLADE

Mercedes Benz
000 500 03 64

Behr/Hella
8MV 376 758-231

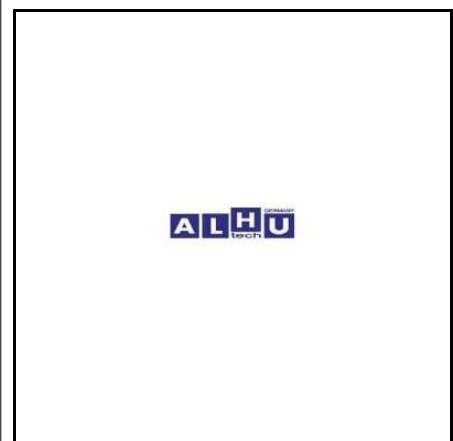

Motor / Engine

28 200 906 FAN BLADE

Mercedes Benz
003 205 29 06



63 451 133 FAN BLADE

Mercedes Benz
904 205 01 06



11 200 722 FAN CLUTCH

new

SPRINTER

Mercedes Benz
000 200 37 22

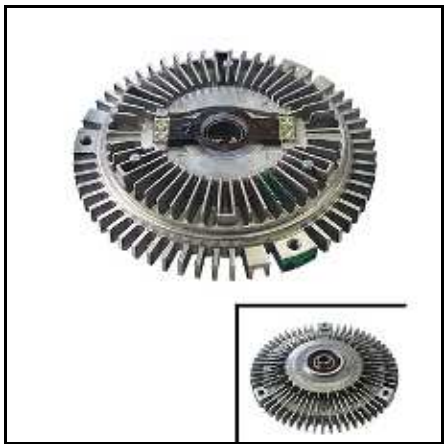

11 201 522 FAN CLUTCH

new

Mercedes Benz
603 200 05 22

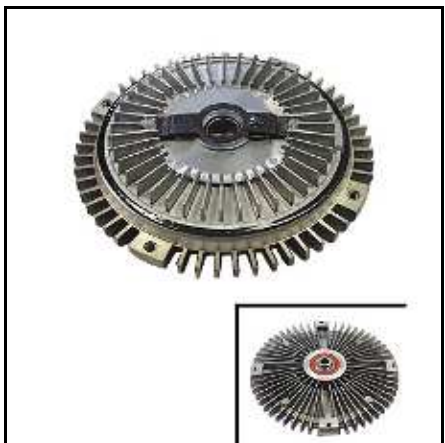

Motor / Engine

11 201 822 FAN CLUTCH



SPRINTER

Mercedes Benz
000 200 58 22

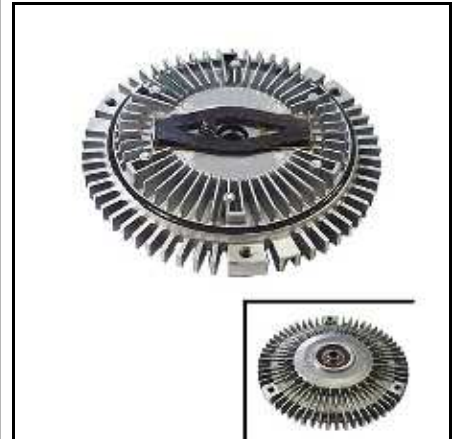

11 206 122 FAN CLUTCH



SPRINTER

Mercedes Benz
000 200 51 22



21 200 003 FAN CLUTCH

with plastic fan

Mercedes Benz
002 205 97 06

Behr/Hella
8MV 376 728-741

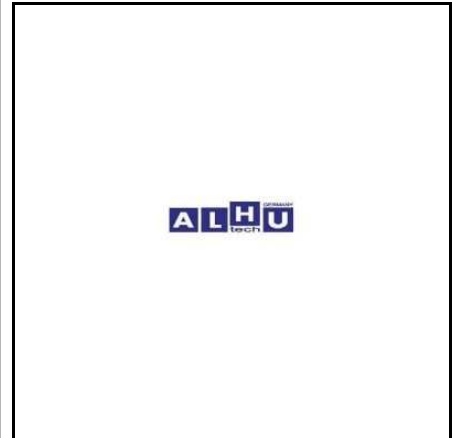

21 200 004 FAN CLUTCH

Mercedes Benz
366 200 04 22

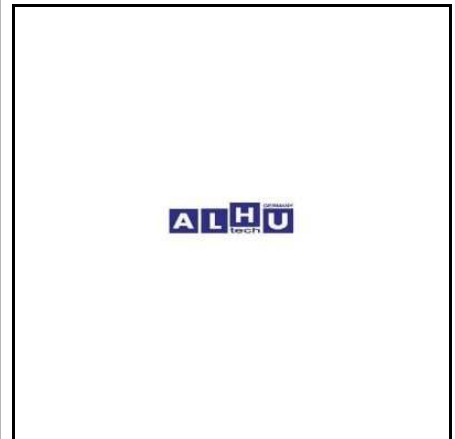

Motor / Engine

21 200 029 FAN CLUTCH

ACTROS

Mercedes Benz
541 200 13 22



21 200 030 FAN CLUTCH

ACTROS

Mercedes Benz
541 200 15 22
541 200 18 22

BERU
LK 117



21 200 222 FAN CLUTCH

ACTROS

Mercedes Benz
000 200 82 22



21 200 322 FAN CLUTCH

ACTROS

Mercedes Benz
000 200 42 22
000 200 83 22

Behr/Hella
8MV 376 728-381



Motor / Engine

21 200 422 FAN CLUTCH

Mercedes Benz
000 200 46 22

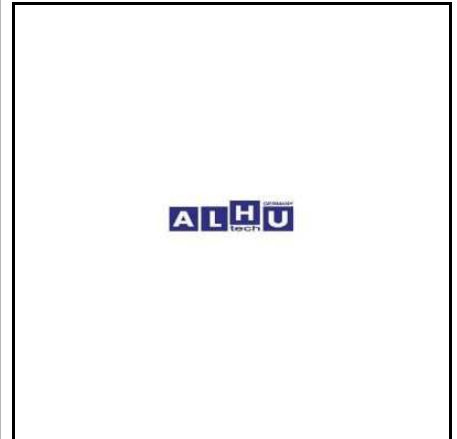

21 200 522 FAN CLUTCH

ATEGO

Mercedes Benz
904 200 08 22



21 200 622 FAN CLUTCH

AXOR

Mercedes Benz
000 200 67 22

Behr/Hella
8MV 376 730-101



21 200 722 FAN CLUTCH

ACTROS

Mercedes Benz
000 200 81 22

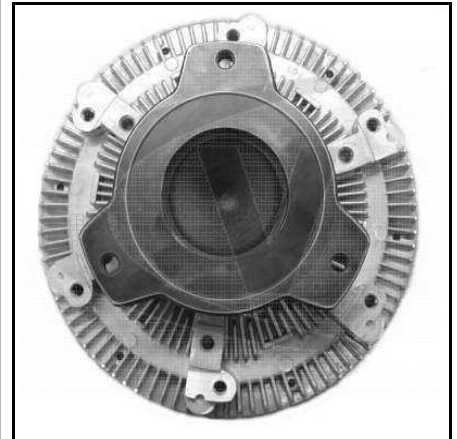

Motor / Engine

21 200 822 FAN CLUTCH

ATEGO

Mercedes Benz
906 200 08 22
906 200 18 22

Behr/Hella
8MV 376 731-351



21 201 422 FAN CLUTCH

ACTROS

Mercedes Benz
000 200 84 22

Behr/Hella
8MV 376 729-481



21 201 622 FAN CLUTCH

Mercedes Benz
541 200 06 22



63 451 404 FAN CLUTCH
with plastic fan

 **Mercedes Benz**
002 205 65 06



Motor / Engine

21 500 055 FAN SHROUD

Mercedes Benz
620 505 03 55

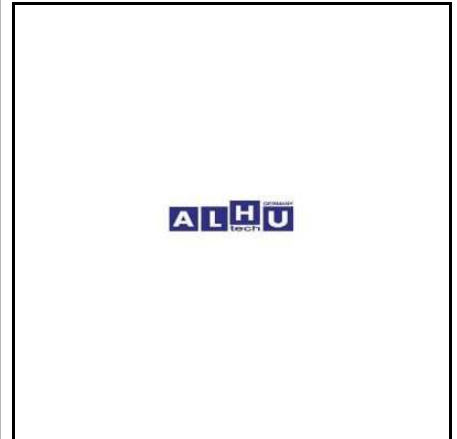

21 500 155 FAN SHROUD

Mercedes Benz
620 505 06 55



21 200 926 FAN SPACER

Mercedes Benz
403 200 09 26



28 000 003 FILTER HOUSING

Mercedes Benz
000 094 30 04
31 100 54 113

MAN
81.08304.0023

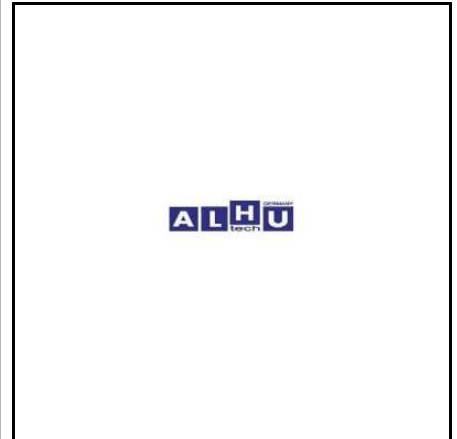

Motor / Engine

21 094 001 FILTER INSERT

Mercedes Benz
000 094 82 04

Mann + Hummel
3116054103

MAN
81.08405.0006

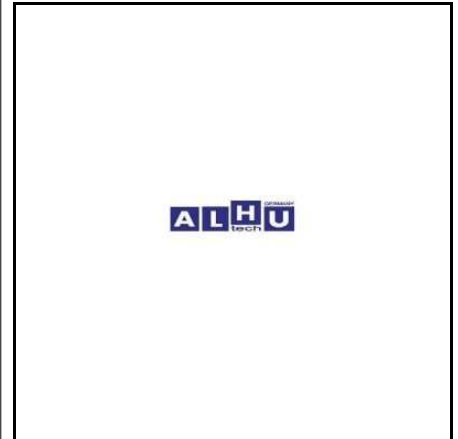

21 830 013 FLUID RESERVOIR

Mercedes Benz
000 830 17 83

MAN
81.61910.0013



21 030 305 FLYWHEEL

dual mass

Mercedes Benz
457 030 13 05
457 030 26 05

Neoplan
110688875

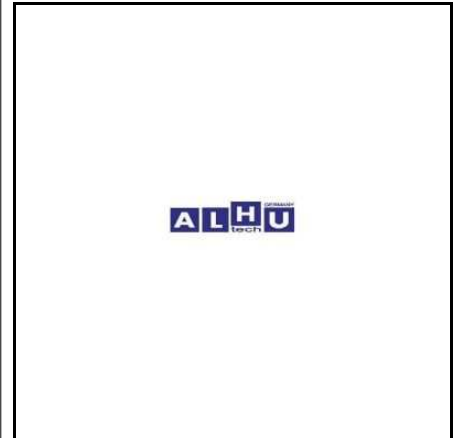

21 030 352 FLYWHEEL

OM 364

Mercedes Benz
352 030 73 05

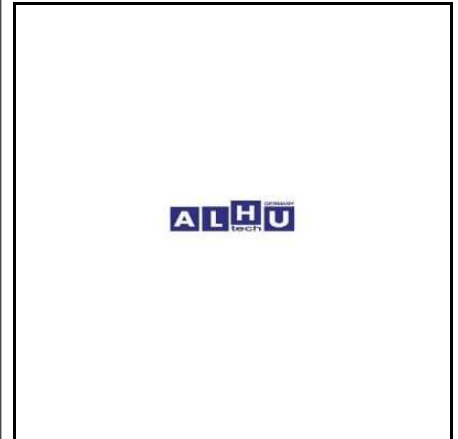

Motor / Engine

21 030 353 FLYWHEEL

OM 366

Mercedes Benz
352 030 39 05

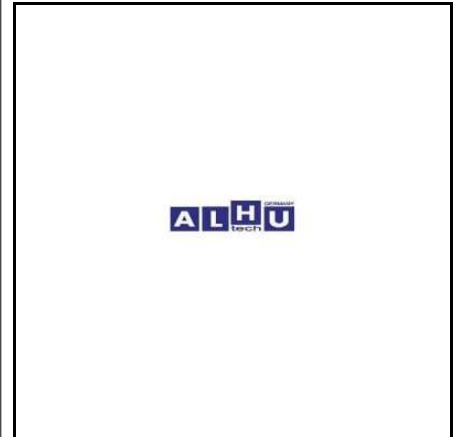

21 030 402 FLYWHEEL

380 MM

OM 401 - 402

Mercedes Benz
403 030 13 05

MAN
51.02301.7295

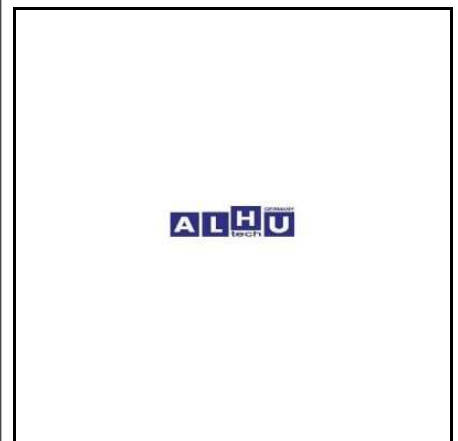

21 030 403 FLYWHEEL

420 mm

Mercedes Benz
403 030 14 05

MAN
51.02301.7300

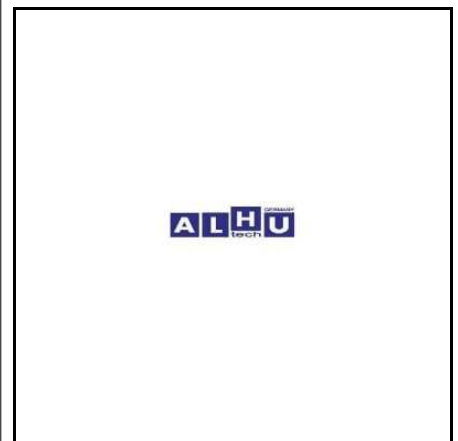

21 030 441 FLYWHEEL

400 mm

Mercedes Benz
441 030 04 05

MAN
51.02301.7410

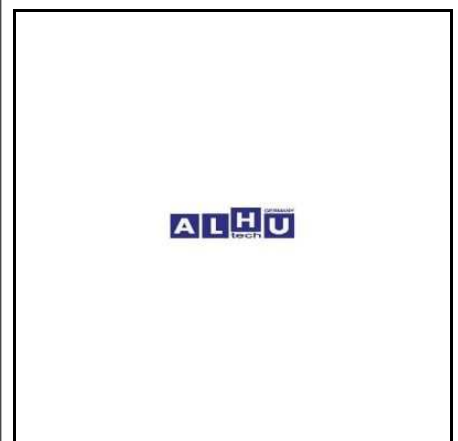

Motor / Engine

21 030 442	FLYWHEEL
	430 mm
Mercedes Benz	
442 030 02 05	

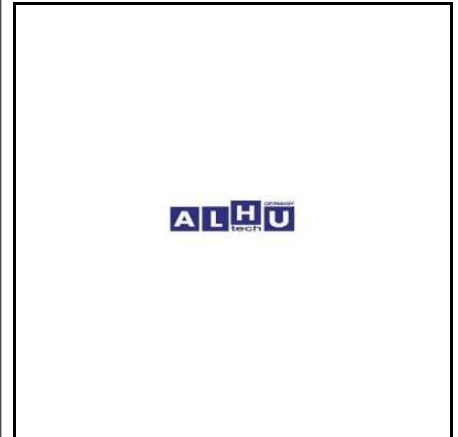

21 030 445	FLYWHEEL
Mercedes Benz	
442 030 19 05	

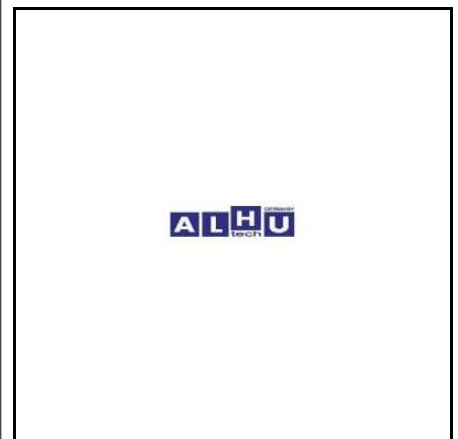

21 030 447	FLYWHEEL
Mercedes Benz	
447 030 18 05	

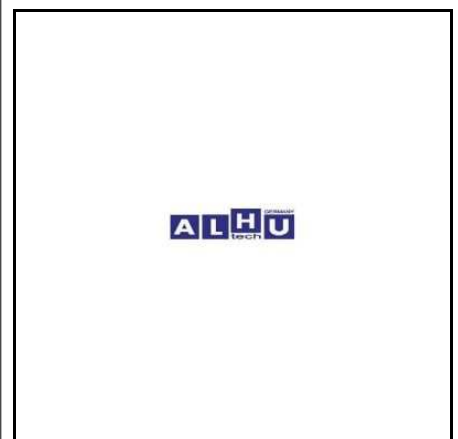

21 030 457	FLYWHEEL
	430 mm
	AXOR
Mercedes Benz	
457 030 06 05	

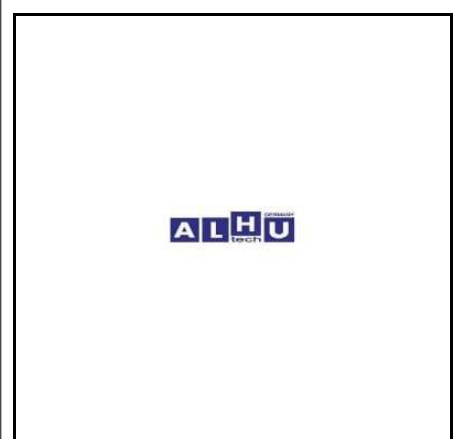

Motor / Engine

21 030 521 FLYWHEEL

Mercedes Benz
541 030 01 05

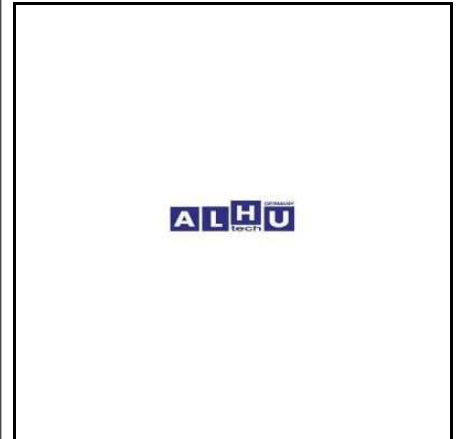

21 030 905 FLYWHEEL
395 mm

AXOR

Mercedes Benz
906 030 19 05

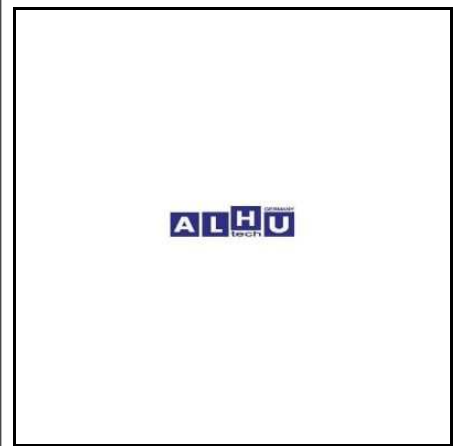

21 030 906 FLYWHEEL

ATEGO

Mercedes Benz
906 030 32 05

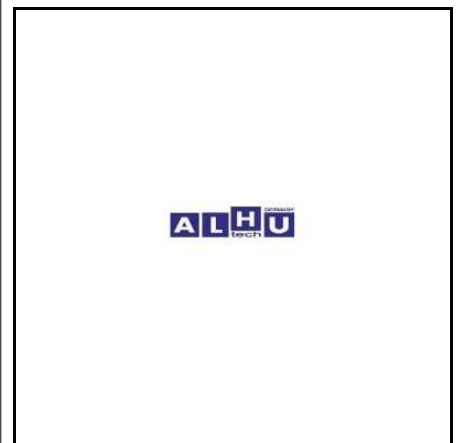

28 030 002 FLYWHEEL

OM 355 TURBO

Mercedes Benz
345 030 02 05

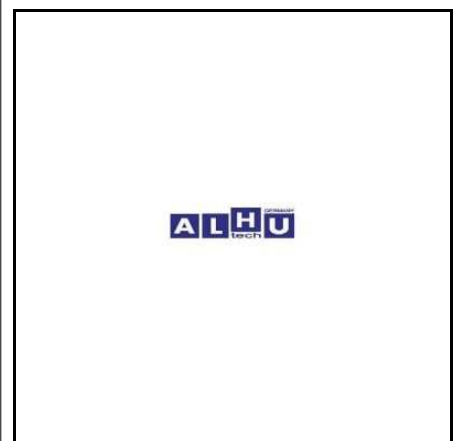

Motor / Engine

28 030 003 FLYWHEEL

Mercedes Benz
364 030 01 05

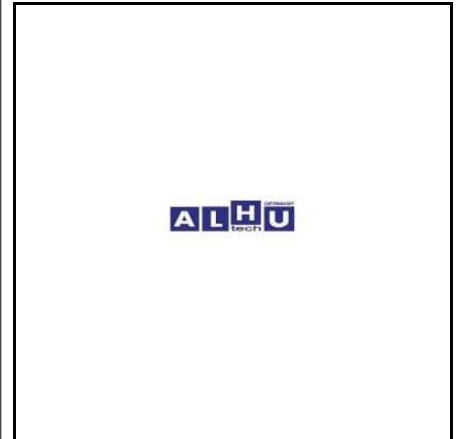

28 030 004 FLYWHEEL

Mercedes Benz
366 030 09 05

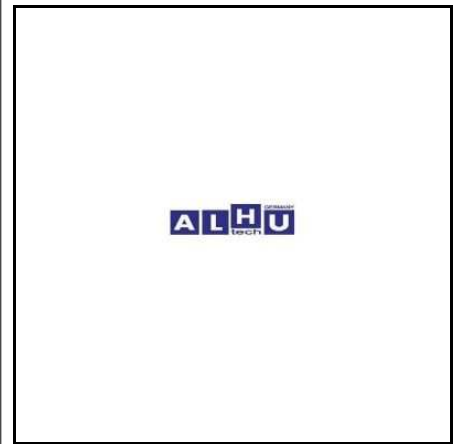

28 030 005 FLYWHEEL

OM 355

Mercedes Benz
355 030 13 05

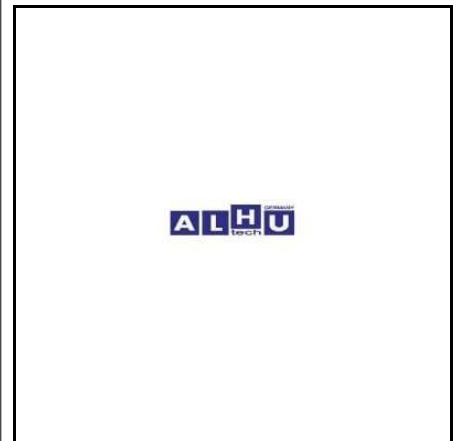

28 030 006 FLYWHEEL

OM 360

Mercedes Benz
327 030 02 11
360 030 08 11

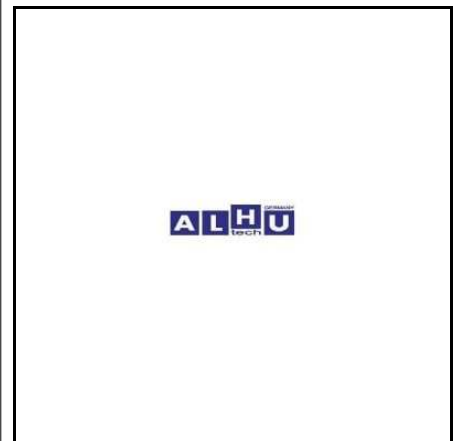

Motor / Engine

28 030 008 FLYWHEEL
dual mass

Mercedes Benz
541 030 03 05



28 030 022 FLYWHEEL

Mercedes Benz
906 030 20 05



28 032 001 FLYWHEEL RING GEAR

Mercedes Benz
403 032 03 05



21 040 003 FUEL FEED PUMP

Mercedes Benz
000 090 03 50

MAN
51.12101.7038
81.12101.6022

Bosch
0 440 008 999



Motor / Engine

21 090 050 FUEL FEED PUMP

Mercedes Benz
000 090 60 50



21 440 001 FUEL FEED PUMP

Mercedes Benz
000 090 73 50

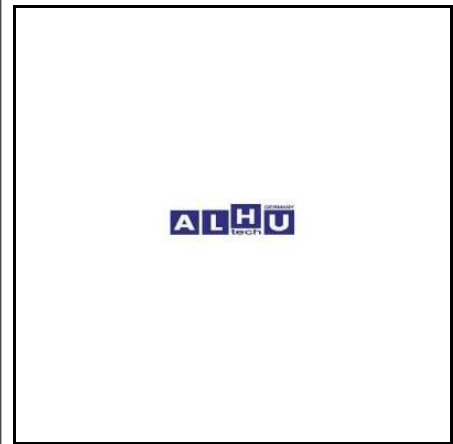

21 440 005 FUEL FEED PUMP

Mercedes Benz
000 090 14 50

Bosch
0 440 008 996



21 440 007 FUEL FEED PUMP

Mercedes Benz
000 091 21 90

KHD
1180583
2408351

Bosch
0 440 011 002
0 440 011 007

MAN
51.12150.7022



Motor / Engine

21 440 009 FUEL FEED PUMP

Bosch
0 440 008 009



21 440 011 FUEL FEED PUMP

Mercedes Benz
000 090 22 50

KHD
3363174

Bosch
0 440 017 996

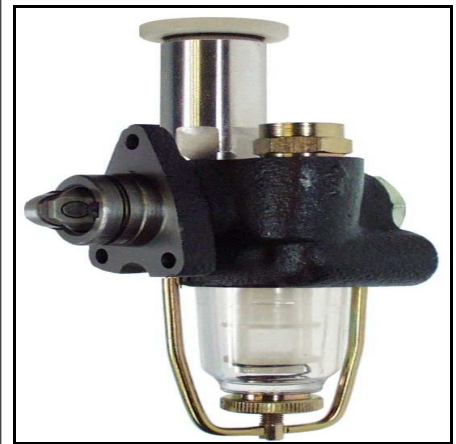

21 440 027 FUEL FEED PUMP

Mercedes Benz
000 090 06 50

Bosch
0 440 008 027
0 440 008 997



21 440 043 FUEL FEED PUMP

Mercedes Benz
000 090 21 50

Bosch
0 440 008 994

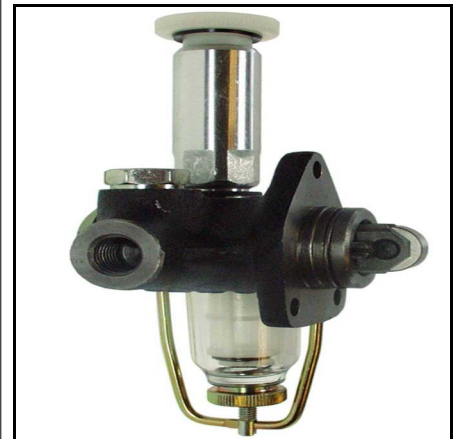

Motor / Engine

21 440 071 FUEL FEED PUMP

Mercedes Benz
003 091 27 01

Bosch
0 440 008 071

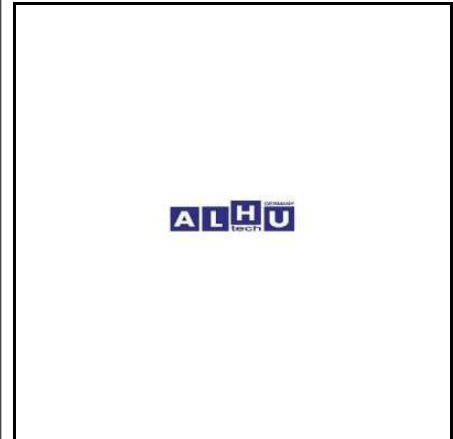

21 440 176 FUEL FEED PUMP

Mercedes Benz
000 090 02 50

Bosch
0 440 003 176



21 440 177 FUEL FEED PUMP

Mercedes Benz
000 090 27 50

MAN
51.12101.7034

Bosch
0 440 003 996



21 440 238 FUEL FEED PUMP

Mercedes Benz
001 091 73 01

KHD
1174845
93190254

Bosch
0 440 003 238



Motor / Engine

21 440 240 FUEL FEED PUMP

Mercedes Benz
000 090 10 50

Bosch
0 440 003 998



21 440 989 FUEL FEED PUMP

Mercedes Benz
000 090 31 50

Bosch
0 440 008 989



21 440 996 FUEL FEED PUMP

Mercedes Benz
000 090 11 50

Bosch
0 440 004 996



21 440 998 FUEL FEED PUMP

Mercedes Benz
000 090 05 50

MAN
51.12101.7040

Bosch
0 440 008 007
0 440 008 998

Volvo
244391
1699140



Motor / Engine

21 447 000 HAND PUMP

with spring

Mercedes Benz
000 091 11 01

MAN
51.12150.7002

Bosch
2 447 222 000



21 447 020 HAND PUMP

ALUMINIUM HOUSING

Mercedes Benz
000 090 00 50

Scania
192882

Bosch
2 447 222 020

Volvo
76703



21 447 045 HAND PUMP

Mercedes Benz
000 090 88 50

Volvo
3094547

Bosch
2 447 010 045



63 451 412 HEATER VALVE



Mercedes Benz
000 830 13 84

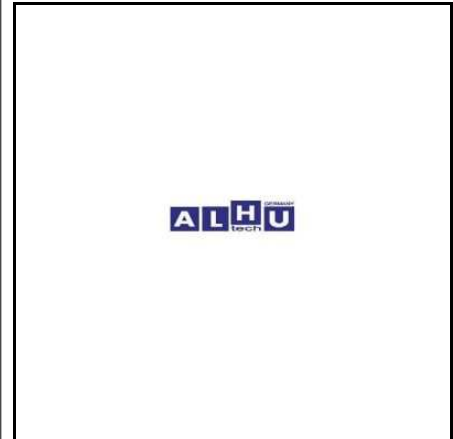

Motor / Engine

63 451 413 HEATER VALVE



Mercedes Benz
000 830 35 84

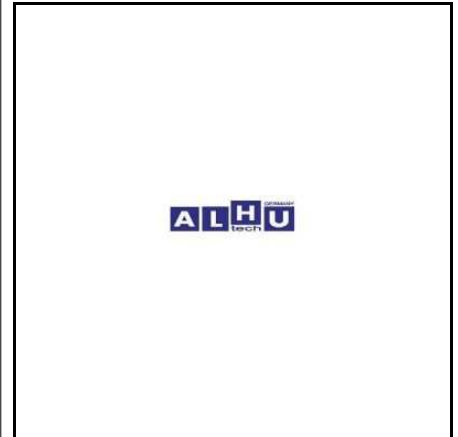

21 203 030 HOSE

Mercedes Benz
900 271 05 50 00

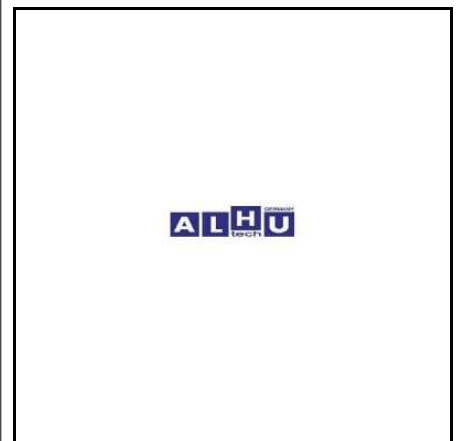

63 450 260 HUB

Mercedes Benz
301 206 01 13

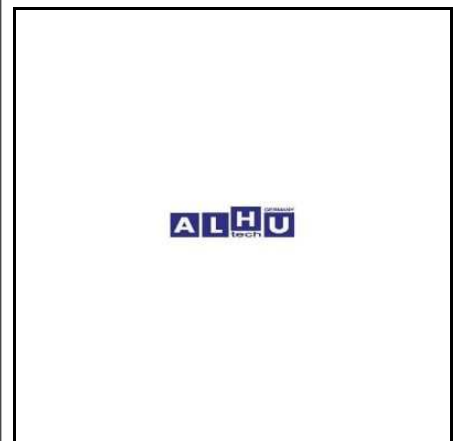

21 203 004 INJECTION LINE SET

Mercedes Benz
442 070 96 33

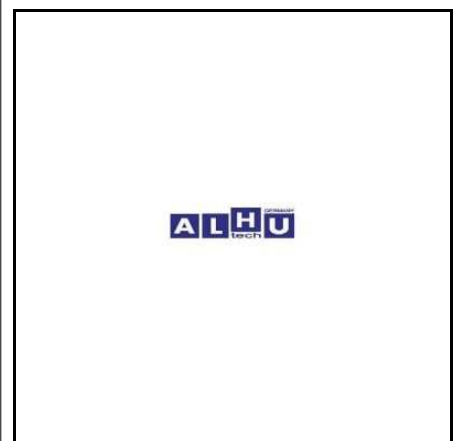

Motor / Engine

21 203 005 INJECTION LINE SET

Mercedes Benz
442 070 81 33

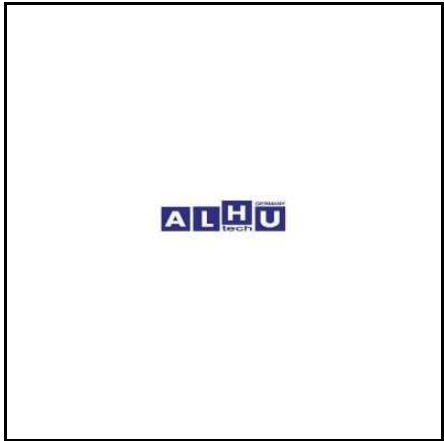

21 203 006 INJECTION LINE SET

Mercedes Benz
441 070 11 33



21 203 007 INJECTION LINE SET

Mercedes Benz
441 070 55 33



21 203 014 INJECTION LINE SET

Mercedes Benz
407 070 01 36

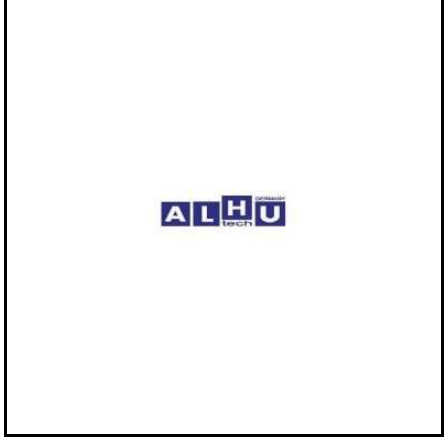

Motor / Engine

21 203 015 INJECTION LINE SET

Mercedes Benz
447 070 21 33



21 203 028 INJECTION LINE

Mercedes Benz
422 070 78 33



21 203 029 INJECTION LINE

Mercedes Benz
346 070 10 33



63 450 993 INJECTION LINE

Mercedes Benz
346 070 03 35



Motor / Engine

63 450 994 INJECTION LINE

Mercedes Benz
423 070 23 33



21 997 065 INJECTOR WASHER

Mercedes Benz
346 017 01 60

MAN
51.98701.0065



28 000 017 INTERCOOLER PIPE

Mercedes Benz
457 098 33 07



28 000 018 INTERCOOLER PIPE

Mercedes Benz
457 203 06 30



Motor / Engine

63 450 847 INTERMEDIATE PIECE



Mercedes Benz
422 035 11 14

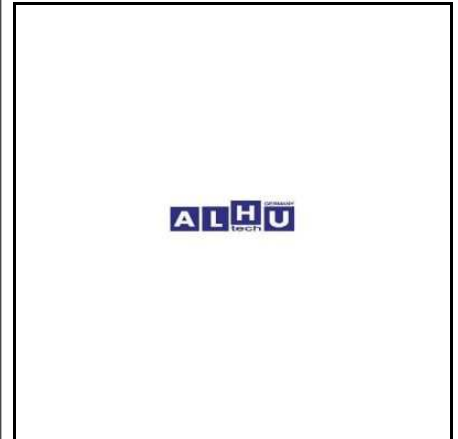

63 450 261 NUT

Mercedes Benz
301 206 00 72

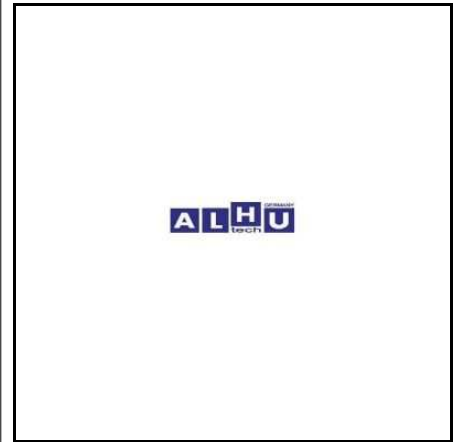

12 018 302 OIL CAP

Mercedes Benz
000 010 02 85
000 018 07 02
111 018 03 02



21 180 165 OIL COOLER

Mercedes Benz
355 180 11 65

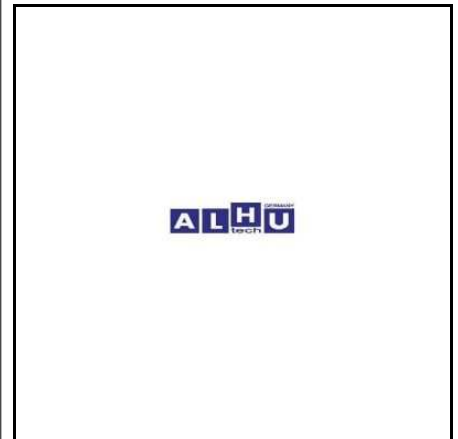

Motor / Engine

21 180 265 OIL COOLER

Mercedes Benz
355 180 12 65

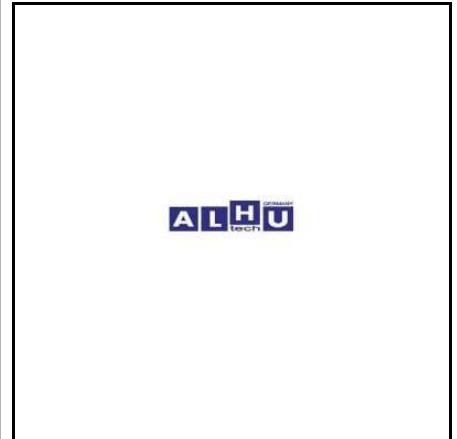

21 188 001 OIL COOLER

Mercedes Benz
001 188 31 01

MAN
51.05601.0121



21 188 201 OIL COOLER

Mercedes Benz
541 188 02 01



21 188 301 OIL COOLER

Mercedes Benz
002 188 43 01

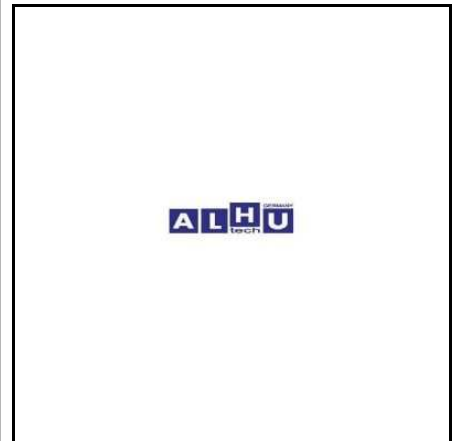

Motor / Engine

21 188 401 OIL COOLER

Mercedes Benz
422 188 01 01

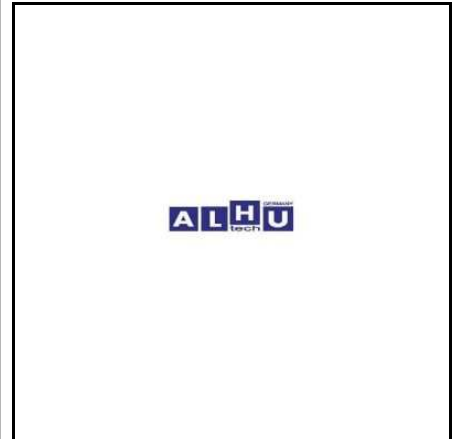

21 188 501 OIL COOLER

Mercedes Benz
422 188 00 01

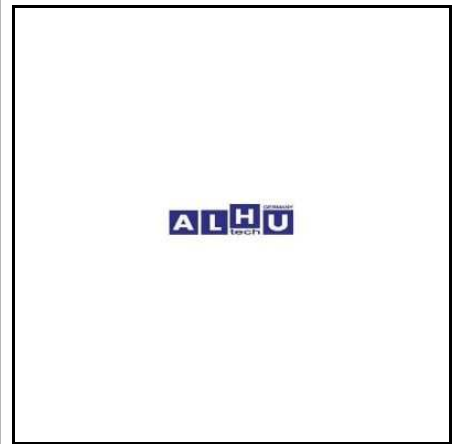

21 188 801 OIL COOLER

Mercedes Benz
001 188 88 01

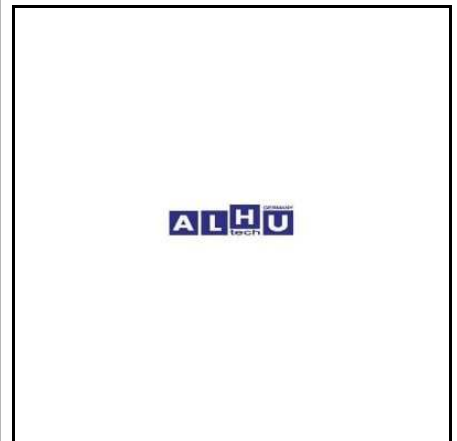

21 010 072 OIL DIPSTICK

Mercedes Benz
541 010 10 72

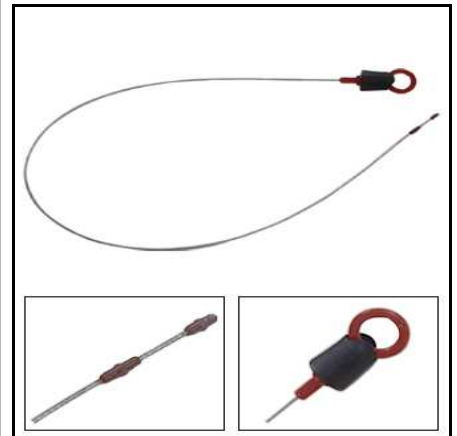

Motor / Engine

21 010 272 OIL DIPSTICK

Mercedes Benz
442 010 32 72



21 010 972 OIL DIPSTICK

Mercedes Benz
457 010 03 72



21 011 072 OIL DIPSTICK

Mercedes Benz
422 010 00 72
442 010 00 72

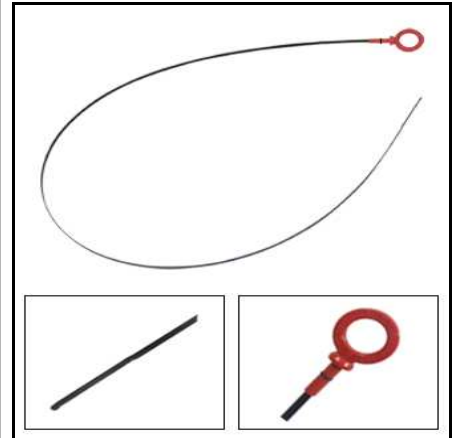

21 011 372 OIL DIPSTICK

Mercedes Benz
403 010 33 72

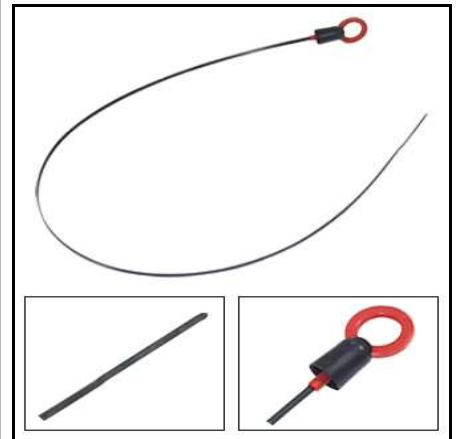

Motor / Engine

21 011 872 OIL DIPSTICK

Mercedes Benz
422 010 18 72

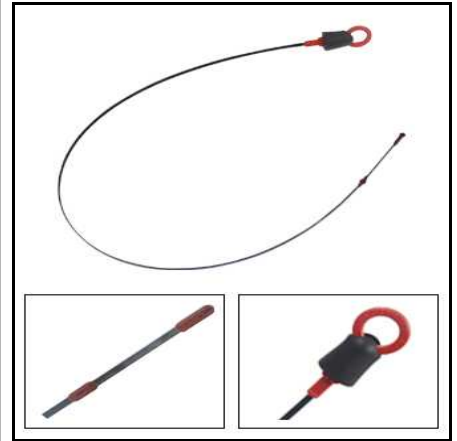

21 180 238 OIL FILTER COVER

Mercedes Benz
000 180 24 38

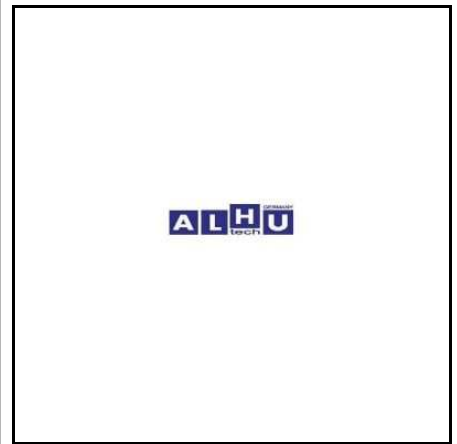

63 451 154 OIL FILTER COVER

Mercedes Benz
000 180 23 38

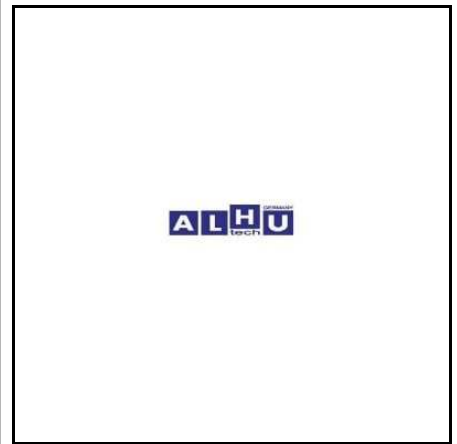

21 180 438 OIL FILTER HEAD

Mercedes Benz
403 180 14 38

MAN
51.05503.6006

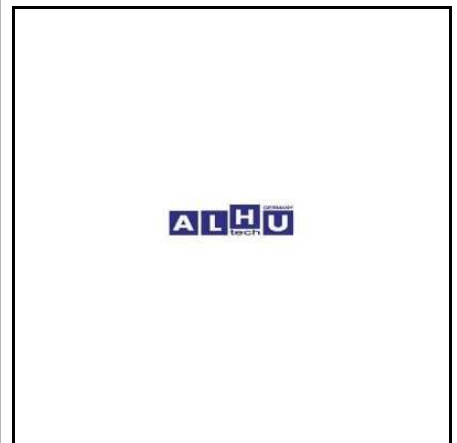

Motor / Engine

21 180 938 OIL FILTER HEAD

Mercedes Benz
403 180 39 38

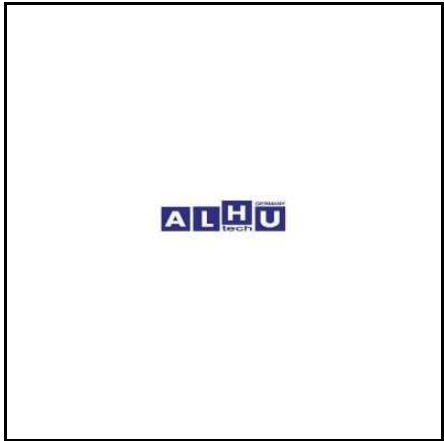

28 000 001 OIL FILTER HEAD

Mercedes Benz
407 180 11 38

MAN
51.05503.6096



63 451 417 OIL FILTER HOUSING

NEW

Mercedes Benz
906 180 17 10



21 203 027 OIL LINE

Mercedes Benz
423 180 09 20

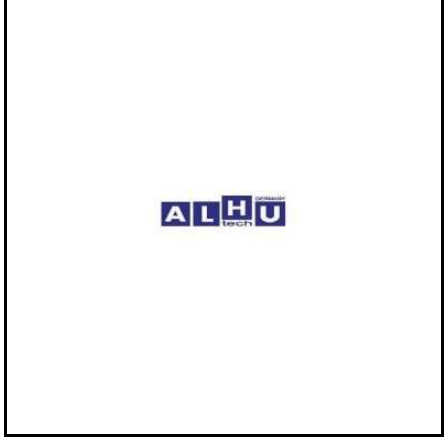

Motor / Engine

63 451 416 OIL LINE

new

Mercedes Benz
542 180 09 22



21 180 543 OIL NOZZLE

Mercedes Benz
442 180 05 43



63 450 583 OIL NOZZLE

Mercedes Benz
541 180 08 43



63 451 418 OIL NOZZLE

new

Mercedes Benz
541 180 07 43

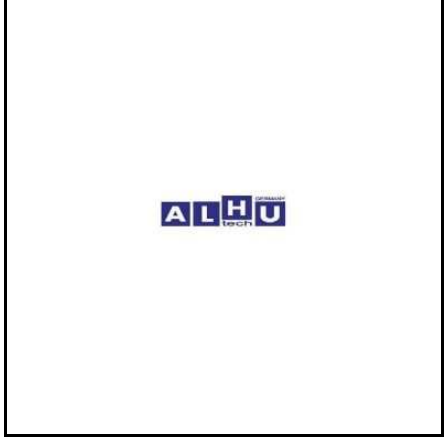

Motor / Engine

21 010 313 OIL PAN

Mercedes Benz
906 010 13 13



28 010 713 OIL PAN

ACTROS

Mercedes Benz
541 010 07 13



28 010 813 OIL PAN

ATEGO

Mercedes Benz
904 010 38 13



28 011 213 OIL PAN

ACTROS

Mercedes Benz
541 010 12 13



Motor / Engine

63 450 574 OIL PAN

Mercedes Benz
442 010 06 13



21 180 101 OIL PUMP

Mercedes Benz
355 180 01 01



21 180 201 OIL PUMP

Mercedes Benz
542 180 00 01
542 180 01 01
542 180 02 01



21 180 301 OIL PUMP

Mercedes Benz
541 180 03 01

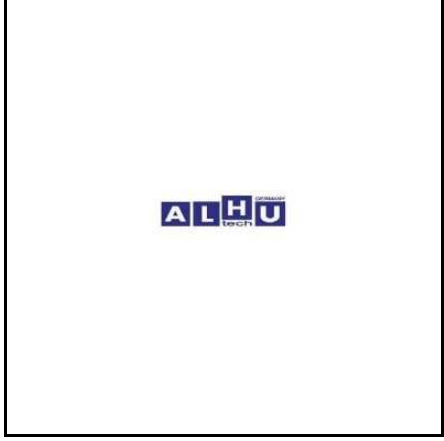

Motor / Engine

21 180 501 OIL PUMP

Mercedes Benz

423 180 05 01
423 180 25 01

MAN

51.05100.6279

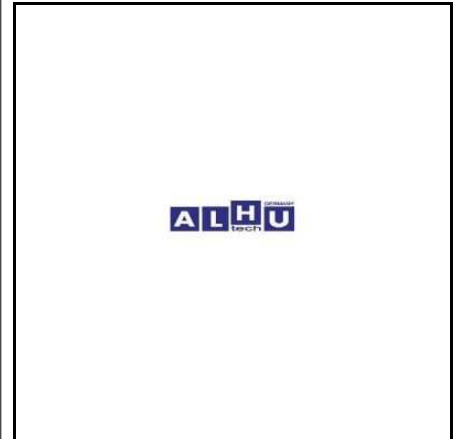

21 180 701 OIL PUMP

Mercedes Benz

403 180 17 01

MAN

51.05100.6133

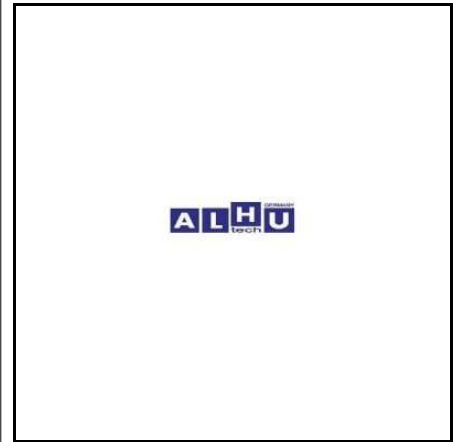

21 180 801 OIL PUMP

Mercedes Benz

403 180 28 01

MAN

51.05100.6135

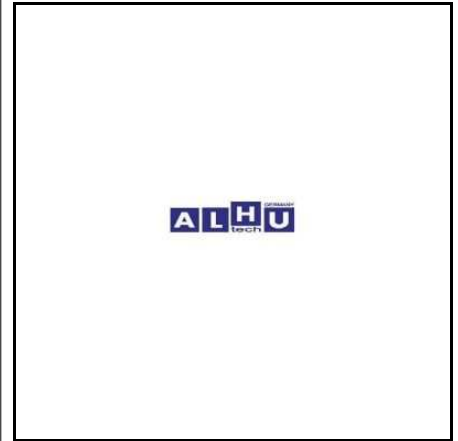

21 180 015 OIL RELIEF VALVE

Mercedes Benz

442 180 00 15

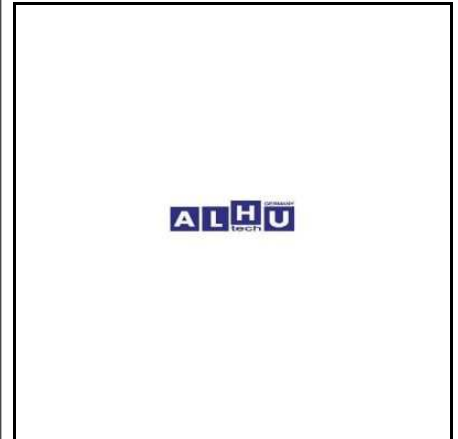

Motor / Engine

21 180 315 OIL RELIEF VALVE

Mercedes Benz
422 180 03 15

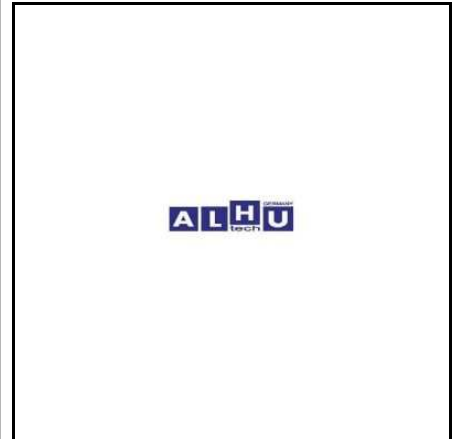

21 018 835 OIL SEPARATOR

Mercedes Benz
000 018 38 35

Mann + Hummel
3900067352



21 018 335 OIL SEPERATOR

Mercedes Benz
000 018 13 35

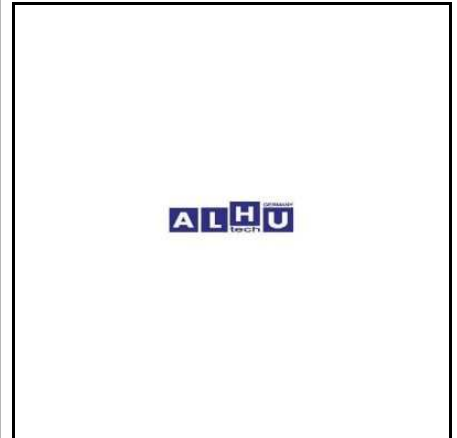

21 018 535 OIL SEPERATOR

Mercedes Benz
352 010 01 62

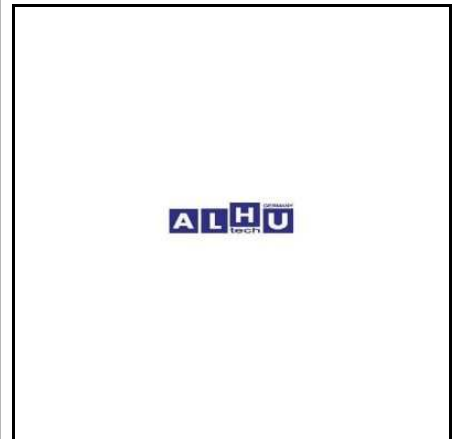

Motor / Engine

21 018 536 OIL SEPERATOR

Mercedes Benz
000 018 58 35

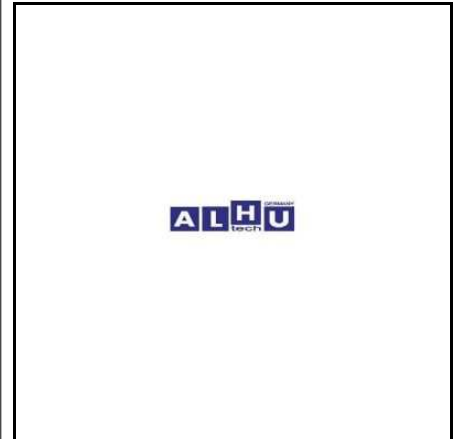

21 018 635 OIL SEPERATOR

Mercedes Benz
000 018 57 35



21 018 735 OIL SEPERATOR

Mercedes Benz
000 018 37 35

Mann + Hummel
3900067103



21 074 515 OVERFLOW VALVE

M 14 x 1,5

Mercedes Benz
000 074 05 15

DAF
245187

Bosch
1 417 413 000

MAN
51.12505.0004

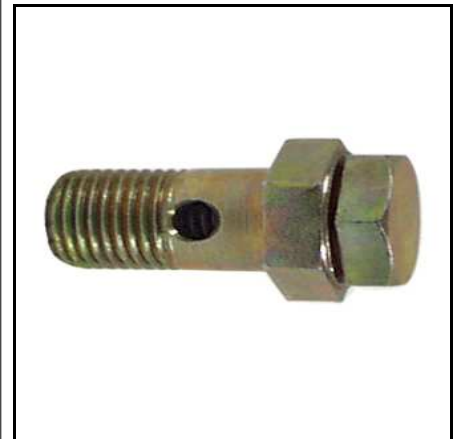

Motor / Engine

21 074 584 OVERFLOW VALVE

Mercedes Benz
000 074 06 84

Bosch
1 417 413 025



21 074 684 OVERFLOW VALVE

Mercedes Benz
000 074 76 84

Bosch
1 417 413 047

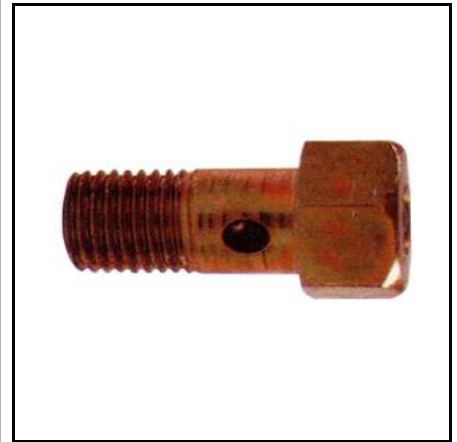

28 070 646 OVERFLOW VALVE

Mercedes Benz
541 070 06 46

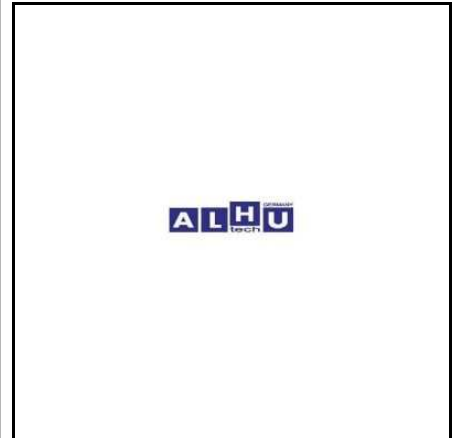

28 413 010 OVERFLOW VALVE

Mercedes Benz
000 477 03 29

MAN
90.81692.9667

Bosch
1 457 413 010

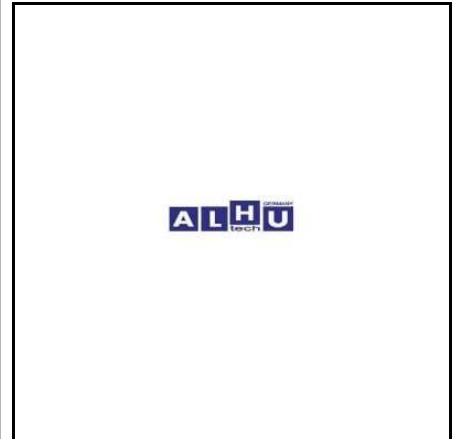

Motor / Engine

21 180 715 PRESSURE RELIEF VALVE

Mercedes Benz
541 180 07 15

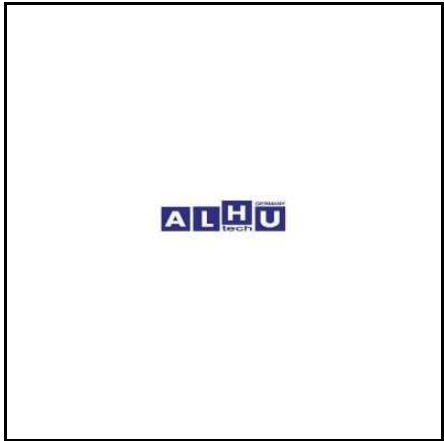

21 017 003 PRESSURE SCREW

Mercedes Benz
403 017 02 71

MAN
51.10108.0003



21 054 505 PUSH ROD

Mercedes Benz
541 054 05 05



21 146 050 RADIATOR CAP

Mercedes Benz
000 501 45 15

MAN
81.06110.0026



Motor / Engine

21 146 150 RADIATOR CAP

with chain

Mercedes Benz

000 501 46 15

000 501 72 15

MAN

51.97141.0017



21 146 250 RADIATOR CAP

Mercedes Benz

000 501 53 15

Behr/Hella

8MY 376 742-131

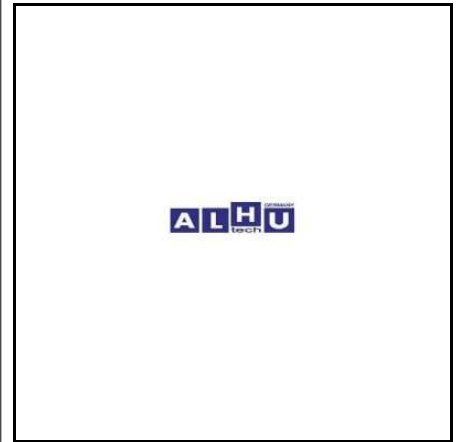

21 146 350 RADIATOR CAP

Mercedes Benz

000 501 64 15

MAN

81.06111.0018

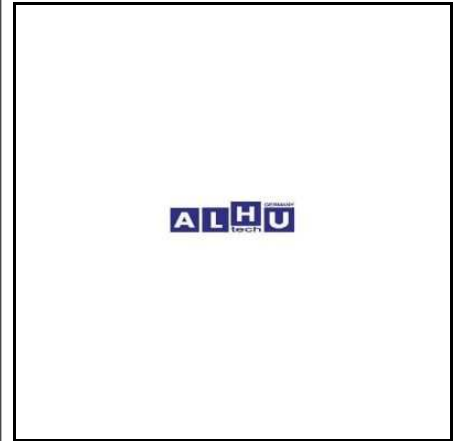

21 094 082 RADIATOR HOSE

Mercedes Benz

371 501 80 82

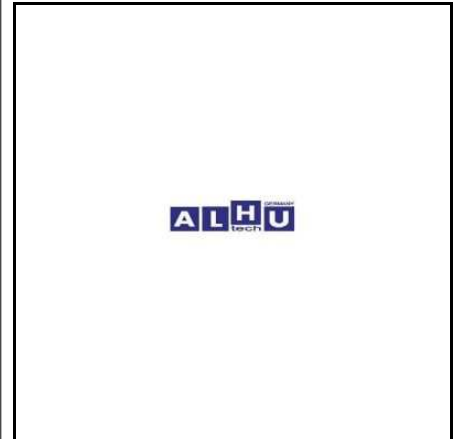

Motor / Engine

21 095 182 RADIATOR HOSE

Mercedes Benz
655 506 00 35



21 095 282 RADIATOR HOSE

Mercedes Benz
942 501 05 82



21 501 382 RADIATOR HOSE

Mercedes Benz
941 501 03 82

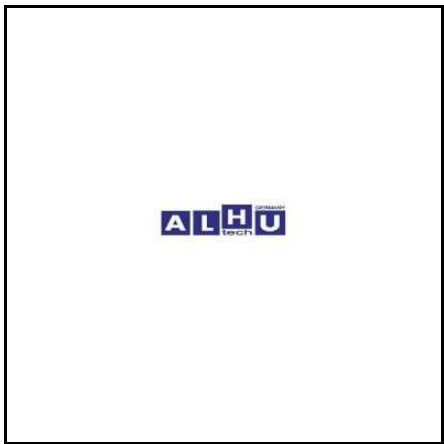

21 501 582 RADIATOR HOSE

Mercedes Benz
941 501 05 82



Motor / Engine

21 501 782 RADIATOR HOSE

Mercedes Benz
940 501 07 82



21 501 982 RADIATOR HOSE

Mercedes Benz
940 501 09 82



63 451 193 RADIATOR HOSE

Mercedes Benz
363 506 02 35



63 451 202 RADIATOR HOSE

Mercedes Benz
387 501 15 82

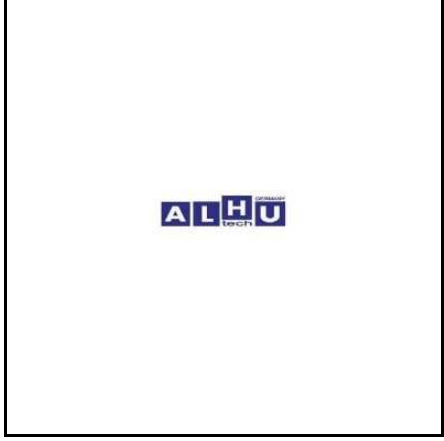

Motor / Engine

63 451 203 RADIATOR HOSE

Mercedes Benz
387 501 16 82



63 451 204 RADIATOR HOSE

Mercedes Benz
387 501 17 82



63 451 219 RADIATOR HOSE

Mercedes Benz
620 501 03 82



63 451 220 RADIATOR HOSE

Mercedes Benz
620 501 28 82



Motor / Engine

63 451 221 RADIATOR HOSE

Mercedes Benz
620 506 00 35



63 451 222 RADIATOR HOSE

Mercedes Benz
620 506 03 35



63 451 223 RADIATOR HOSE

Mercedes Benz
620 528 01 82



63 451 238 RADIATOR HOSE

Mercedes Benz
652 501 24 82

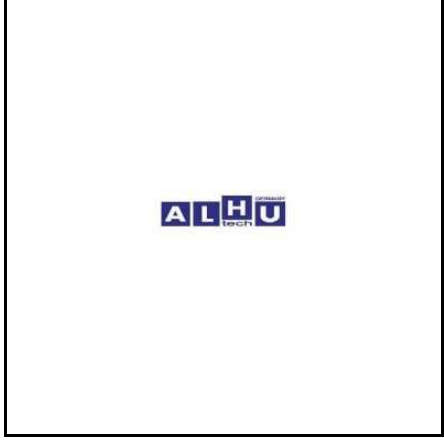

Motor / Engine

63 451 243 RADIATOR HOSE

Mercedes Benz
655 501 04 82



63 451 244 RADIATOR HOSE

Mercedes Benz
655 501 12 82



63 451 246 RADIATOR HOSE

Mercedes Benz
656 501 14 82



63 451 305 RADIATOR HOSE

Mercedes Benz
941 501 07 82



Motor / Engine

63 451 306 RADIATOR HOSE

Mercedes Benz
941 501 12 82



63 451 312 RADIATOR HOSE

Mercedes Benz
942 501 15 82



63 451 313 RADIATOR HOSE

Mercedes Benz
942 506 15 35



63 451 314 RADIATOR HOSE

Mercedes Benz
942 506 32 35



Motor / Engine

21 500 101 RADIATOR MOUNTING

Mercedes Benz
697 987 01 39

MAN
81.96210.0101

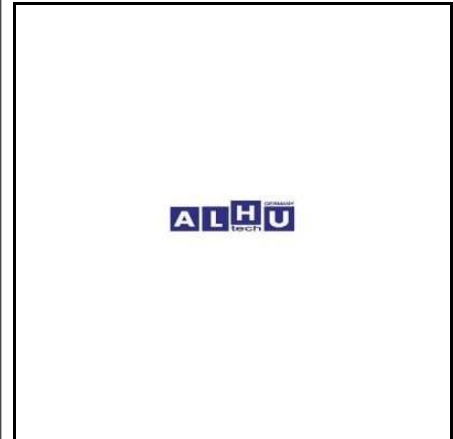

21 090 751 REPAIR KIT

pre-filter, complete

Mercedes Benz
000 090 07 51
000 092 33 03

MAN
51.12503.0050
51.12503.0062



21 447 011 REPAIR KIT

Mercedes Benz
000 090 02 10

DAF
697480

Bosch
2 447 010 011

Volvo
3094313



21 447 016 REPAIR KIT

Mercedes Benz
000 090 01 51

Bosch
2 447 010 016

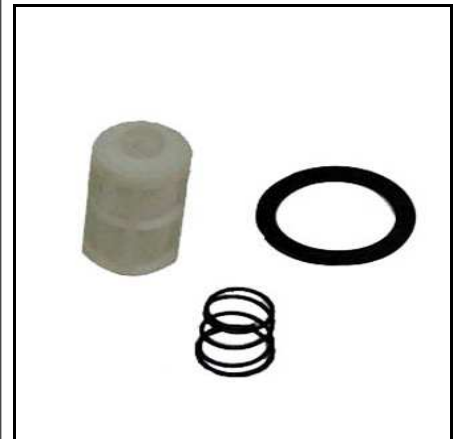

Motor / Engine

21 447 017 REPAIR KIT

Mercedes Benz 000 091 08 40	MAN 81.11101.6012
Bosch 2 447 010 017	



21 447 032 REPAIR KIT
fuel feed pump

Mercedes Benz 000 090 04 07	MAN 81.11101.6151
Bosch 2 447 010 032	RENAULT-TRUCKS 5001823651



28 290 093 REPAIR KIT

Mercedes Benz
970 290 00 93



21 092 330 REPAIR KIT for 000 090 6050

Mercedes Benz
000 092 33 03



Motor / Engine

21 050 236 ROCKER ARM BRACKET

Mercedes Benz
403 050 12 36

MAN
51.04202.5034



21 050 336 ROCKER ARM BRACKET

Mercedes Benz
541 050 12 36



21 050 834 ROCKER ARM, EXHAUST

Mercedes Benz
541 050 08 34



21 050 933 ROCKER ARM, INLET

Mercedes Benz
541 050 09 33

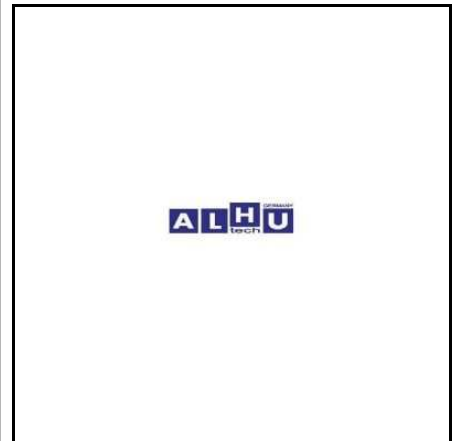

Motor / Engine

21 528 091 RUBBER BELLOW, AIR INTAKE

Mercedes Benz
942 528 00 91

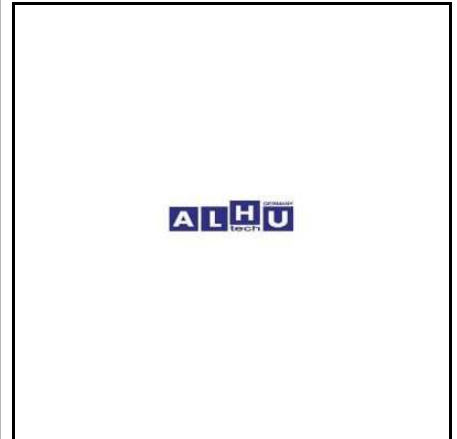

21 528 182 RUBBER BELLOW, AIR INTAKE

Mercedes Benz
655 528 01 82



21 528 191 RUBBER BELLOW, AIR INTAKE

Mercedes Benz
381 528 01 91

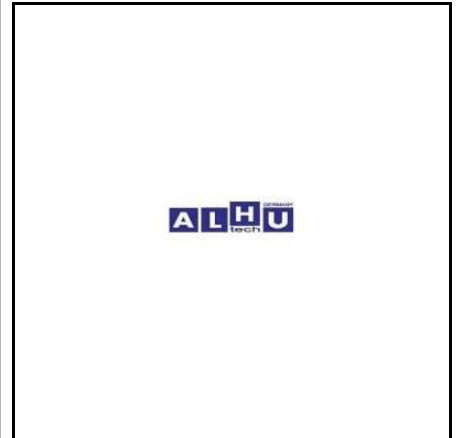

21 528 291 RUBBER BELLOW, AIR INTAKE

Mercedes Benz
650 528 00 91

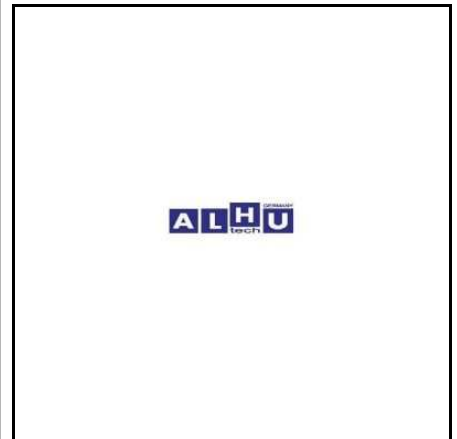

Motor / Engine

21 528 382 RUBBER BELLOW, AIR INTAKE

Mercedes Benz
942 528 03 82

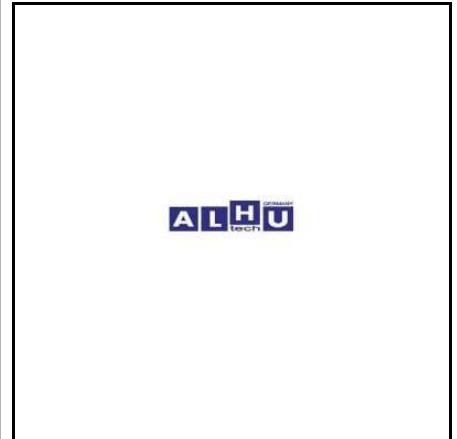

21 528 982 RUBBER BELLOW, AIR INTAKE

Mercedes Benz
940 528 09 82



63 451 409 SCREW



Mercedes Benz
904 990 04 12

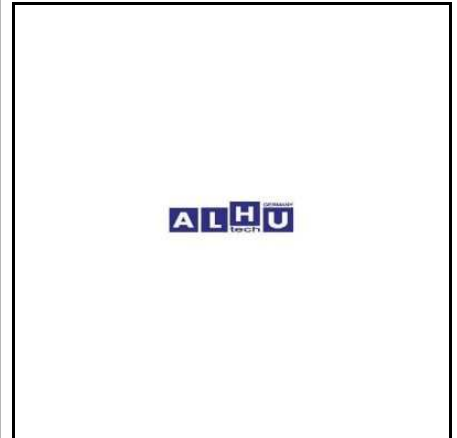

21 997 348 SEAL RING, SEPERATOR

Mercedes Benz
000 997 53 48

MAN
51.96501.0337

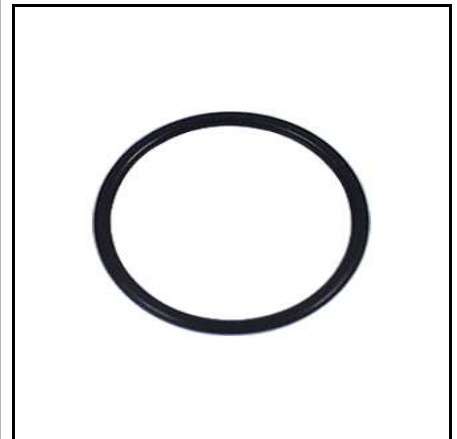

Motor / Engine

21 542 117 SENDER UNIT
FUEL TANK

Mercedes Benz
008 542 81 17



63 450 203 SENDER UNIT

Mercedes Benz
012 542 49 17



63 451 414 SENDER UNIT

 **Mercedes Benz**
011 542 63 17



63 451 415 SENDER UNIT

 **Mercedes Benz**
013 542 71 17



Motor / Engine

21 153 328 SENSOR
OIL PRESSURE

Mercedes Benz
004 153 43 28



63 450 264 SHAFT

Mercedes Benz
301 205 00 02



28 830 184 SOLENOID VALVE

Mercedes Benz
001 830 21 84



28 830 784 SOLENOID VALVE

Mercedes Benz
002 830 27 84



Motor / Engine

21 200 215 THERMOSTAT HOUSING

Mercedes Benz

611 200 02 15

611 200 07 15

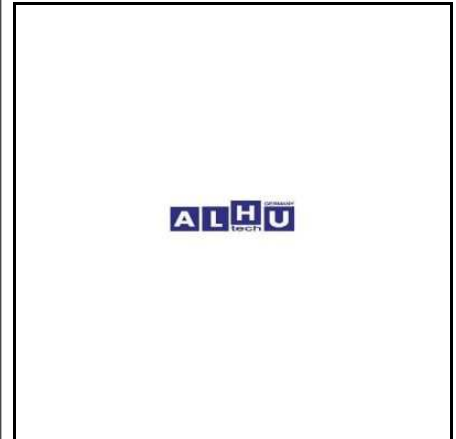

21 204 060 THERMOSTAT 60 DEGREES

with o-ring

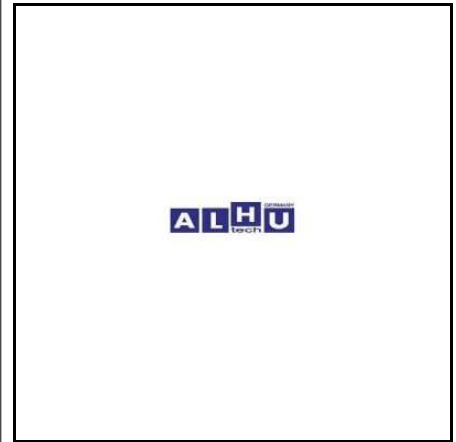

21 204 065 THERMOSTAT 65 DEGREES

with o-ring

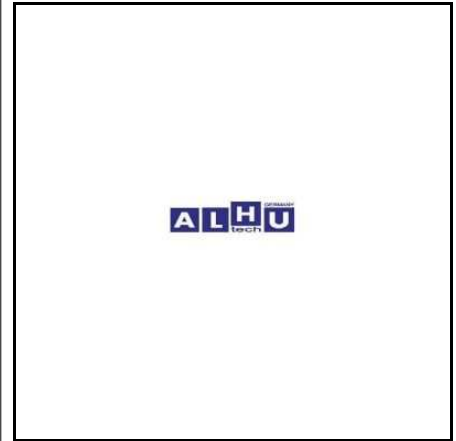

21 204 071 THERMOSTAT 71 DEGREES

with o-ring

Mercedes Benz

004 203 84 75

005 203 28 75

TA501

4150.71D50

MAN

51.06402.0065

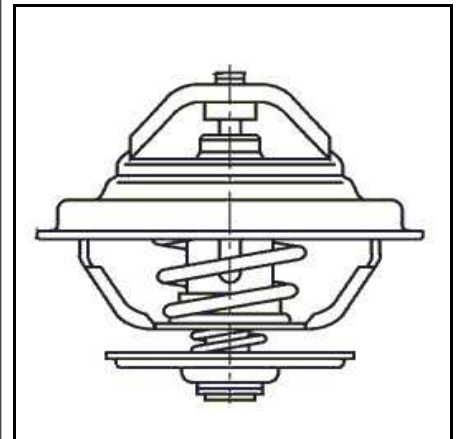

Motor / Engine

21 204 079 THERMOSTAT 79 DEGREES

with o-ring

Mercedes Benz

005 203 27 75

MAN

51.06402.0061

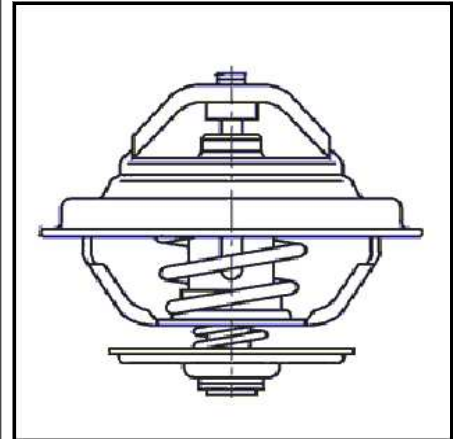

21 204 083 THERMOSTAT 83 DEGREES

with o-ring

Mercedes Benz

005 203 26 75

MAN

51.06402.0060

51.06402.0063

TA501

4150.83D50

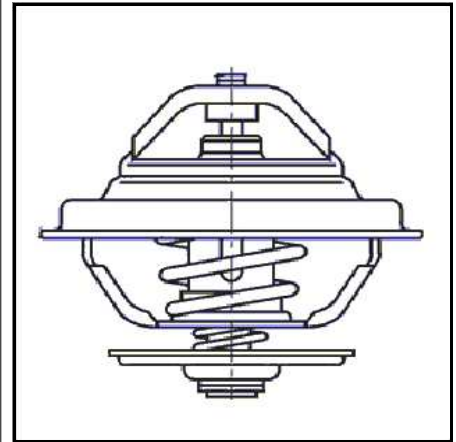

21 140 016 THROTTLE VALVE KIT

Mercedes Benz

541 140 00 63

541 140 01 63



21 140 036 THROTTLE VALVE KIT

Mercedes Benz

441 140 03 63



Motor / Engine

21 140 046 THROTTLE VALVE KIT

Mercedes Benz

441 140 04 63

904 140 00 63



21 140 066 THROTTLE VALVE KIT

Mercedes Benz

542 140 00 63



21 140 096 THROTTLE VALVE KIT

Mercedes Benz

422 140 09 63

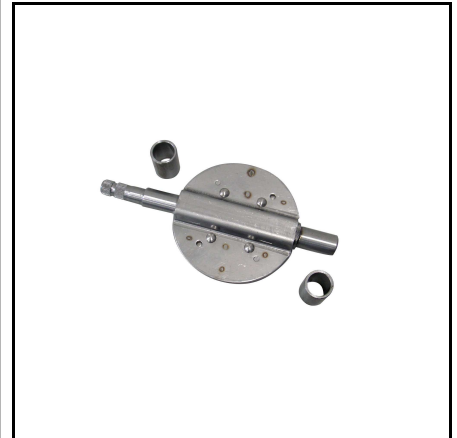

21 140 186 THROTTLE VALVE KIT

Mercedes Benz

447 140 01 63

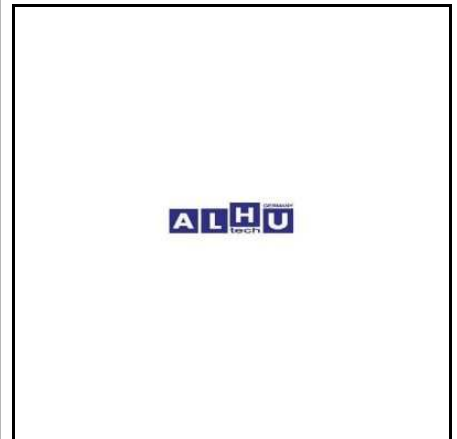

Motor / Engine

21 010 033 TIMING CASE

Mercedes Benz
423 010 50 33



21 010 133 TIMING CASE

Mercedes Benz
541 010 30 33



21 010 233 TIMING CASE

D 2566 D 2866

Mercedes Benz
407 015 07 02

MAN
51.01401.6049



28 000 019 TIMING CASE

MAN
51.01401.6192



Motor / Engine

28 000 020 TIMING CASE

Mercedes Benz
541 010 27 33



21 094 084 TURBO HOSE

Mercedes Benz
000 501 61 82



21 094 085 TURBO HOSE

AXOR

Mercedes Benz
002 094 54 82



21 094 086 TURBO HOSE

Mercedes Benz
001 094 26 82



Motor / Engine

21 094 282 TURBO HOSE

Mercedes Benz
002 094 52 82



21 094 382 TURBO HOSE

Mercedes Benz
002 094 63 82



21 094 682 TURBO HOSE

ACTROS

Mercedes Benz
002 094 55 82
002 094 66 82



21 094 983 TURBO HOSE

Mercedes Benz
002 094 69 82

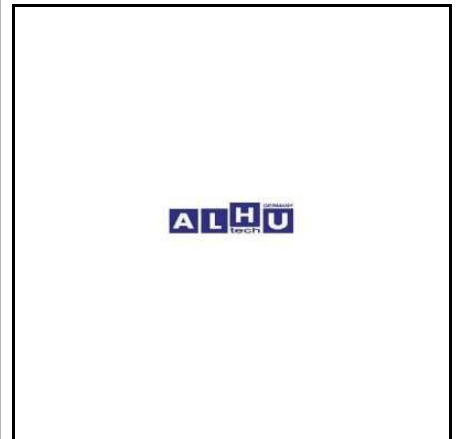

Motor / Engine

21 501 082 TURBO HOSE

ATEGO ACTROS

Mercedes Benz
000 501 00 82
000 501 60 82

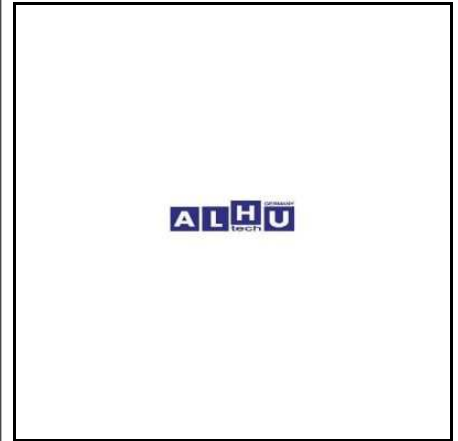

21 501 083 TURBO HOSE

Mercedes Benz
001 501 22 82

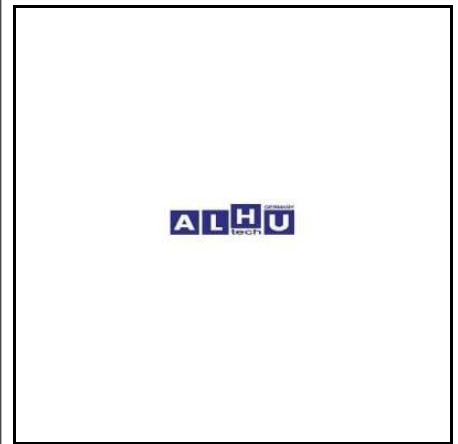

21 501 084 TURBO HOSE

Mercedes Benz
024 997 03 82

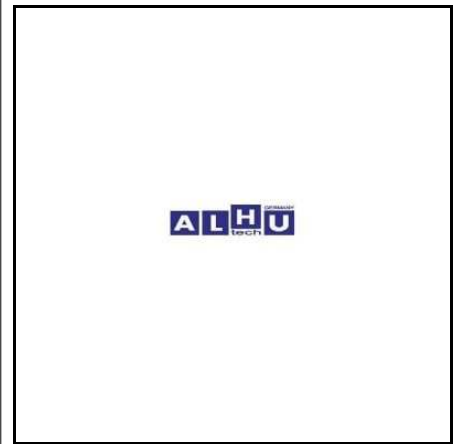

21 501 085 TURBO HOSE

Mercedes Benz
024 997 07 82

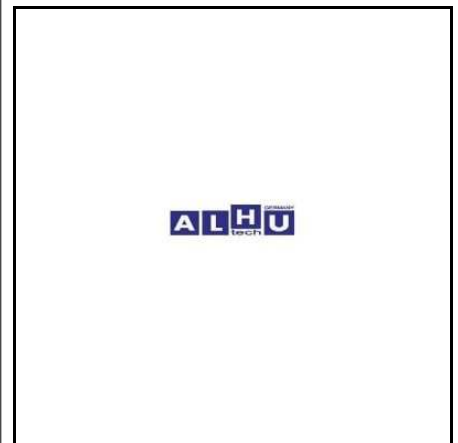

Motor / Engine

63 451 182 TURBO HOSE

Mercedes Benz
002 997 54 52



21 050 025 VALVE TAPPET

Mercedes Benz
476 050 00 25

MAN
51.04301.0109



21 054 101 VALVE TAPPET

Mercedes Benz
403 054 18 01



21 054 501 VALVE TAPPET

Mercedes Benz
352 054 05 01



Motor / Engine

21 054 701 VALVE TAPPET

Mercedes Benz
906 054 07 01



21 200 079 V-BELT PULLEY

Mercedes Benz
403 202 06 10

MAN
51.06503.0122



21 200 080 V-BELT PULLEY

Mercedes Benz
403 202 07 10

MAN
51.06503.0123



28 202 910 V-BELT PULLEY

Mercedes Benz
403 202 09 10



Motor / Engine

63 450 262 V-BELT PULLEY

Mercedes Benz
307 206 02 10



63 450 263 V-BELT PULLEY

Mercedes Benz
305 205 07 10



63 450 265 V-BELT PULLEY

Mercedes Benz
301 206 01 10



63 450 274 V-BELT PULLEY

Mercedes Benz
301 206 02 10



Motor / Engine

63 451 405 V-BELT PULLEY



Mercedes Benz
541 202 01 10

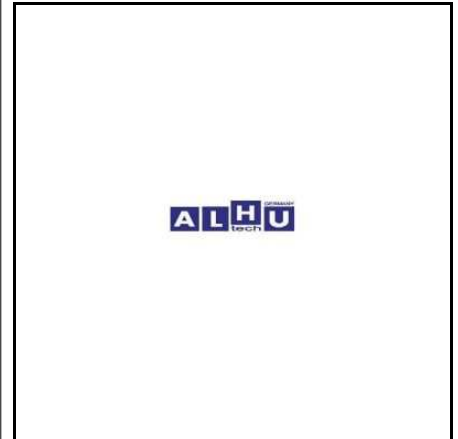

63 451 406 V-BELT PULLEY



Mercedes Benz
906 202 09 10

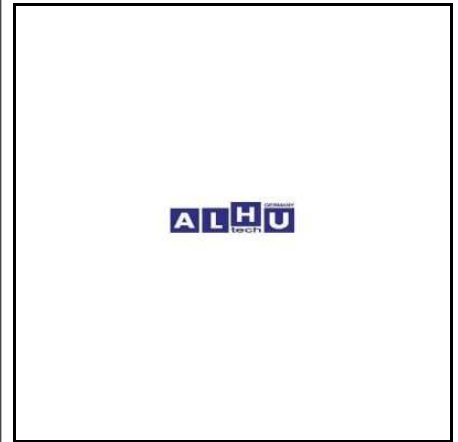

21 200 001 WATER PUMP

Mercedes Benz
541 200 10 01
542 200 20 01
542 200 24 01

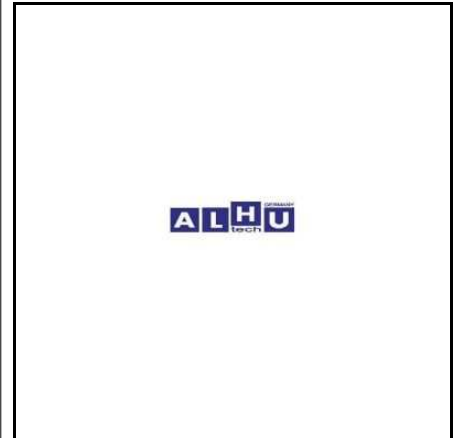

21 200 017 WATER PUMP

Mercedes Benz
353 200 36 01

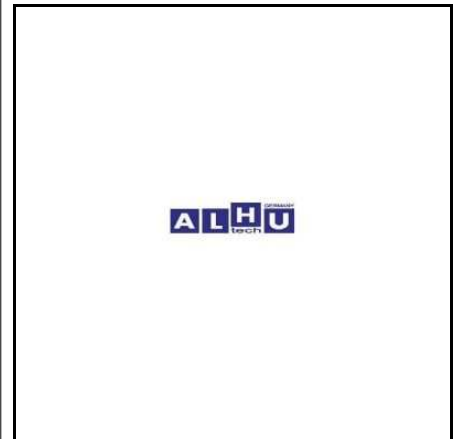

Motor / Engine

21 200 036 WATER PUMP

Mercedes Benz
403 200 70 01

MAN
51.06500.6228

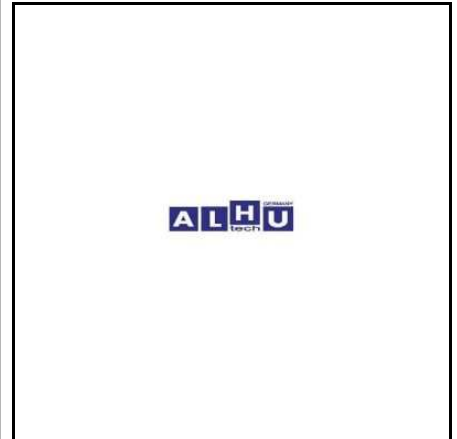

21 200 038 WATER PUMP

Mercedes Benz
403 200 77 01

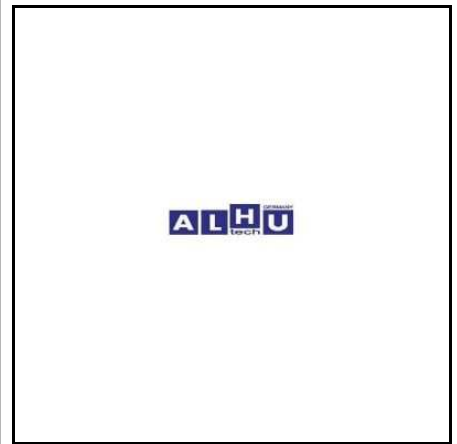

21 200 040 WATER PUMP

Mercedes Benz
441 200 02 01
441 200 03 01

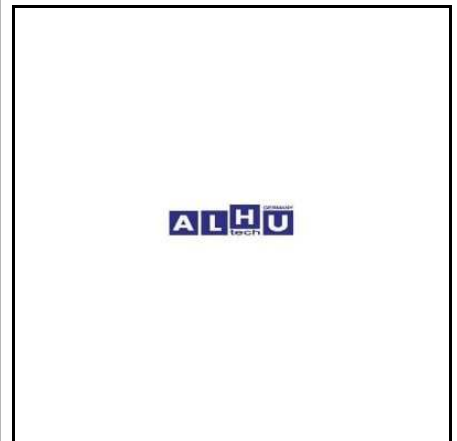

21 200 041 WATER PUMP

Mercedes Benz
457 200 05 01

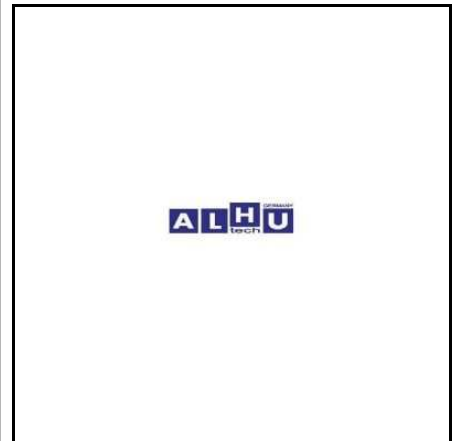

Motor / Engine

21 200 043 WATER PUMP

Mercedes Benz

906 200 57 01
906 200 61 01
906 200 65 01



21 200 044 WATER PUMP

Mercedes Benz

353 200 56 01



21 200 046 WATER PUMP

Mercedes Benz

376 200 00 01



21 200 048 WATER PUMP

Mercedes Benz

457 200 08 01



Motor / Engine

21 200 049 WATER PUMP

Mercedes Benz
457 200 10 01



21 200 050 WATER PUMP

Mercedes Benz
422 200 14 01



21 200 051 WATER PUMP

Mercedes Benz
542 200 22 01



21 200 102 WATER PUMP

Mercedes Benz
403 200 71 01

MAN
51.06500.6282



Motor / Engine

21 200 103 WATER PUMP

Mercedes Benz
542 200 21 01



21 200 201 WATER PUMP

Mercedes Benz
541 200 12 01



21 200 202 WATER PUMP

Mercedes Benz
403 200 73 01



21 200 401 WATER PUMP

Mercedes Benz
904 200 25 01
904 200 49 01



Motor / Engine

21 200 501 WATER PUMP

Mercedes Benz
403 200 75 01
422 200 12 01

MAN
51.06500.6479

TA501
220 816

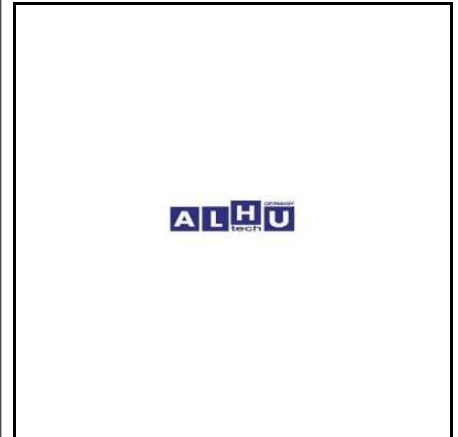

21 200 601 WATER PUMP

Mercedes Benz
422 200 11 01

MAN
51.06500.6426

Frimatec
220 836

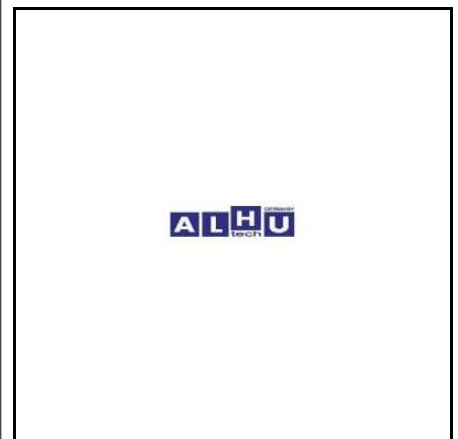

21 200 901 WATER PUMP

Mercedes Benz
366 200 59 01

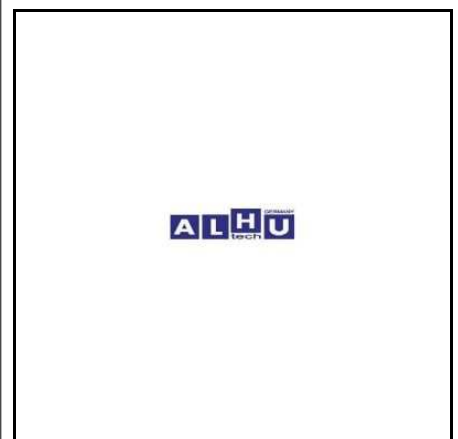

21 200 902 WATER PUMP

Mercedes Benz
422 200 10 01

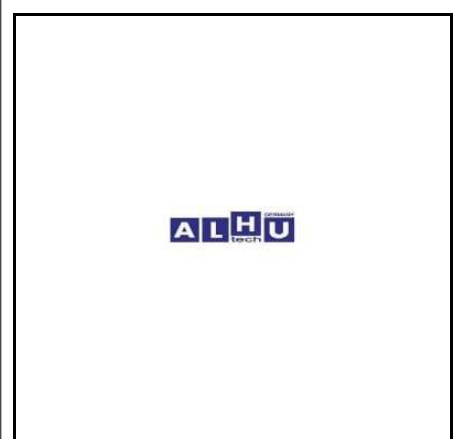

Motor / Engine

24 200 901 WATER PUMP

Mercedes Benz
 542 200 19 01
 542 200 23 01



21 200 034 WATER PUMP KIT

Mercedes Benz
 542 200 01 04



21 200 035 WATER PUMP KIT

Mercedes Benz
 422 200 06 04



21 200 042 WATER PUMP KIT

Mercedes Benz
 904 200 00 04



Motor / Engine

21 999 001 WATER PUMP KIT

Mercedes Benz
422 200 04 04



21 999 004 WATER PUMP KIT

Mercedes Benz
541 200 00 04



21 470 469 WATER SEPARATOR
complete

Mercedes Benz
000 470 04 69



21 477 516 WATER SEPARATOR BOWL

Mercedes Benz
000 477 25 16



Motor / Engine

21 470 004 WATER SEPARATOR FILTER	
Mercedes Benz 000 477 13 02	Mann + Hummel WK 1080/7X
MAN 51.12503.6000	Racor R160T



21 477 508 WATER SEPARATOR HEAD	
Mercedes Benz 000 477 45 08	



Schalter / Switch

63 453 022 AIR PRESSURE SENSOR



Mercedes Benz

004 153 31 28
006 153 14 28

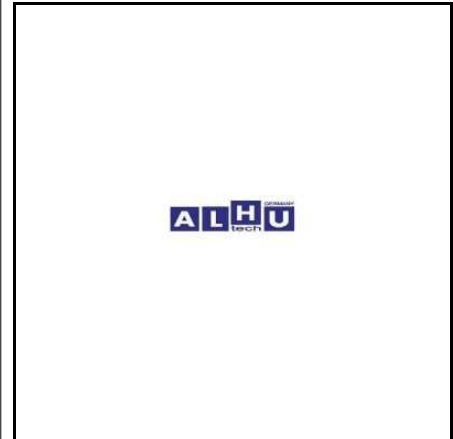

21 545 008 BRAKE LIGHT SWITCH

Mercedes Benz

000 763 14 10

MAN

81.25520.0021

Bosch

0 344 400 008
0 986 345 408

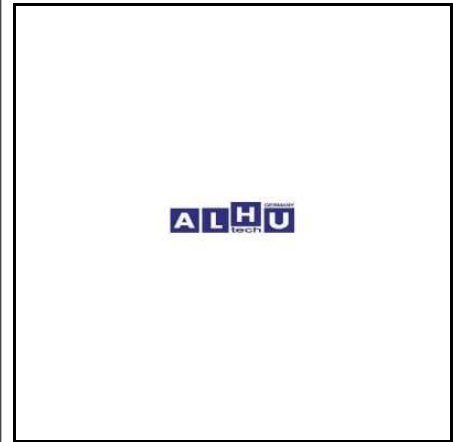

21 545 109 BRAKE LIGHT SWITCH

Mercedes Benz

000 545 77 09
001 545 01 09

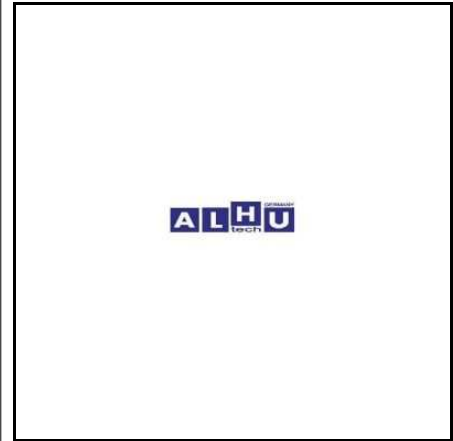

25 545 690 BRAKE LIGHT SWITCH

Mercedes Benz

000 545 69 09

ZF

0501 208 141



Schalter / Switch

25 545 809 BRAKE LIGHT SWITCH

Mercedes Benz
000 545 98 09

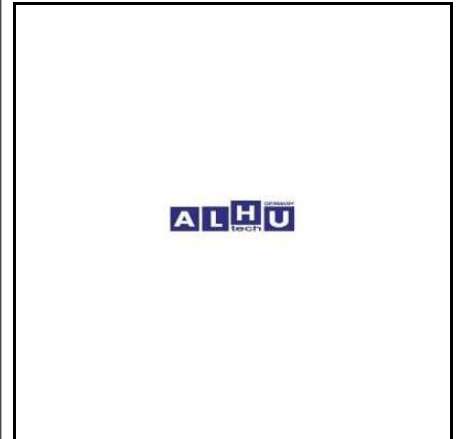

63 453 051 BRAKE LIGHT SWITCH



MAN
81.25520.6007

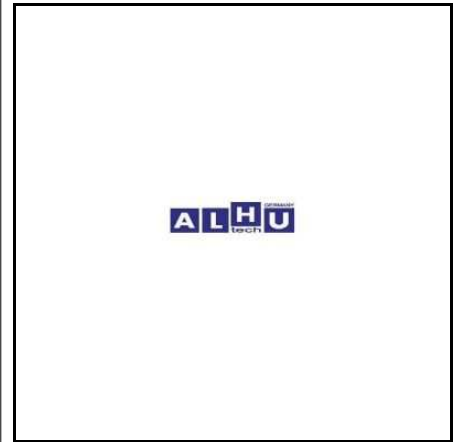

25 545 609 BRAKE-LIGHT SWITCH

Mercedes Benz
001 545 38 09

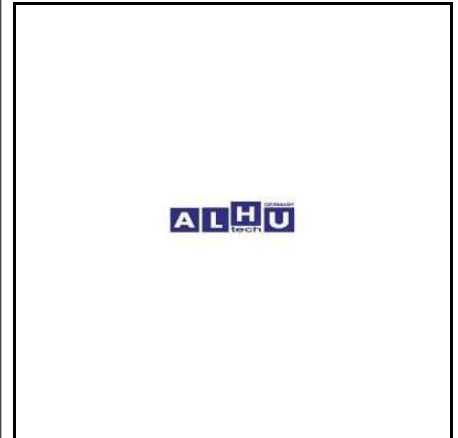

29 546 001 CABLE CONNECTOR

Mercedes Benz
001 546 54 41

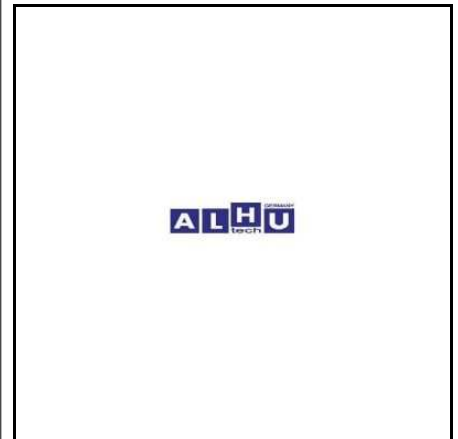

Schalter / Switch

28 820 010 DOOR CONTACT SWITCH

Mercedes Benz
000 821 05 52

MAN
81.25505.0989

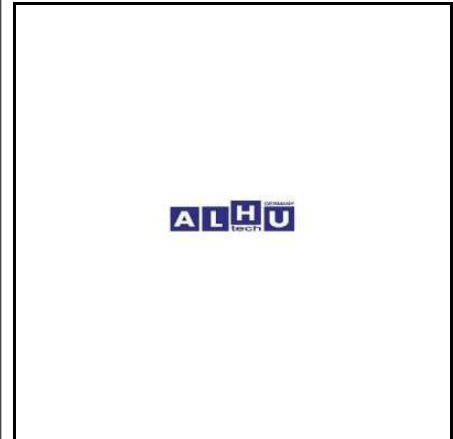

25 545 009 EXHAUST BRAKE SWITCH

Mercedes Benz
000 545 60 09
003 545 92 14

Bosch
0 344 400 010

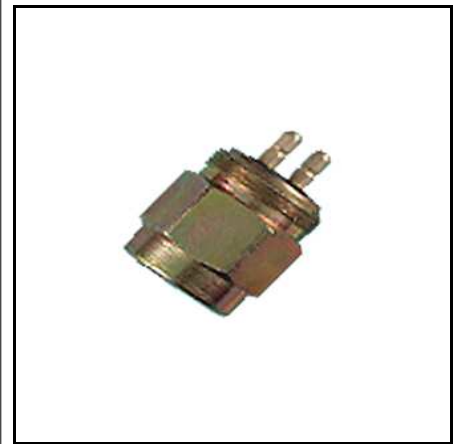

25 545 224 HAZARD WARNING SWITCH

SK

Mercedes Benz
005 545 92 24



25 545 013 IGNITION SWITCH

with key

Mercedes Benz
000 545 30 13

MAN
81.25501.6005

Bosch
0 342 106 005



Schalter / Switch

25 545 413 IGNITION SWITCH

Mercedes Benz
000 545 54 13



29 545 001 LIGHT SWITCH

Mercedes Benz
000 545 37 04

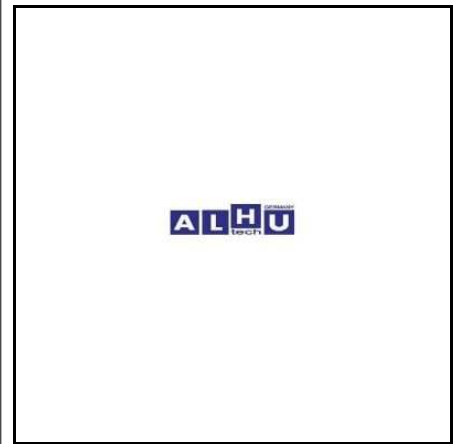

25 545 000 MAIN BATTERY SWITCH

Mercedes Benz
000 545 25 08
000 545 84 08

MAN
81.25506.7000

Bosch
0 341 002 003

Volvo
240315



25 542 902 OIL PRESSURE GAUGE

Mercedes Benz
001 542 99 02

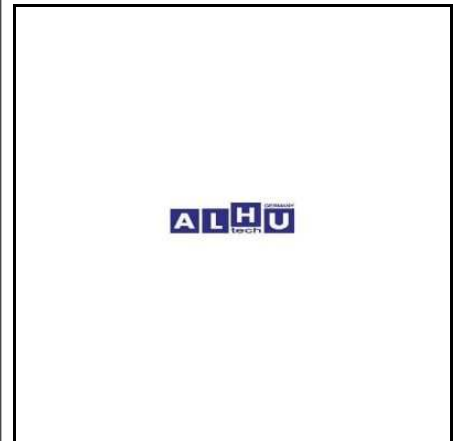

Schalter / Switch

21 542 517 OIL PRESSURE SWITCH

ACTROS

Mercedes Benz
012 542 05 17

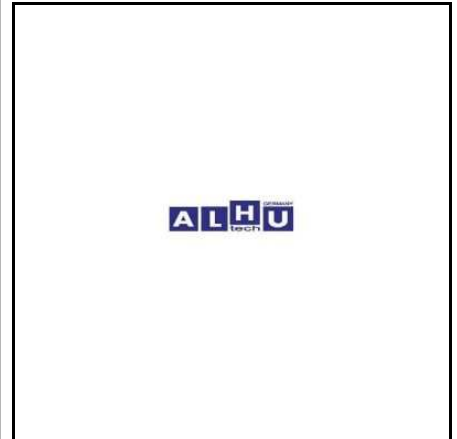

25 542 171 OIL PRESSURE SWITCH

M18X1,5, 0-5 BAR, 0,25+0,15

Mercedes Benz
002 542 17 17



25 542 417 OIL PRESSURE SWITCH

Mercedes Benz
005 542 94 17

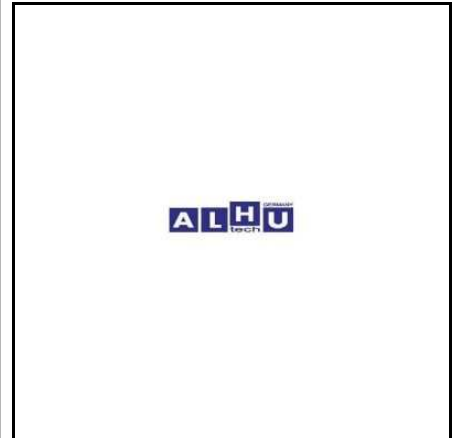

25 542 431 OIL PRESSURE SWITCH

M 18x1,5 mm - 0-5 BAR

Mercedes Benz
004 542 43 17



Schalter / Switch

25 542 891 OIL PRESSURE SWITCH

M14x1,5 mm - 0 - 5,0 BAR

Mercedes Benz

004 542 89 17

VDO

360-081-029-065



29 545 011 OIL PRESSURE SWITCH

Mercedes Benz

000 153 99 32



29 545 009 PRESSURE SWITCH

Mercedes Benz

006 545 11 14



29 545 010 PRESSURE SWITCH

Mercedes Benz

004 545 54 14

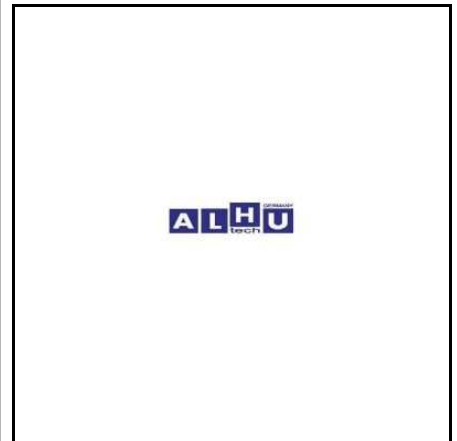

Schalter / Switch

63 451 480 PRESSURE SWITCH



Mercedes Benz
000 763 29 10

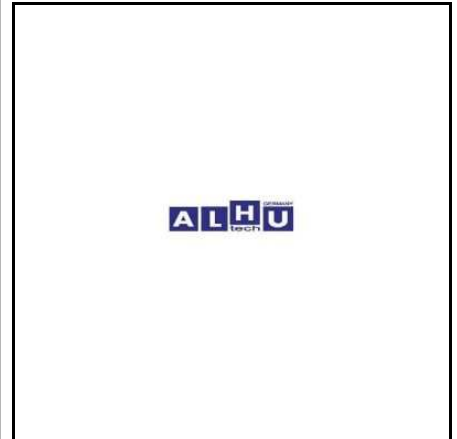

25 542 001 PULSE GENERATOR

Mercedes Benz
009 542 10 17



63 450 095 PUSH BUTTON SWITCH

green

Mercedes Benz
004 545 99 14

MAN
81.25503.6243



AK27501 PUSH KEY



Mercedes Benz
002 545 21 14

MAN
81.25503.0222

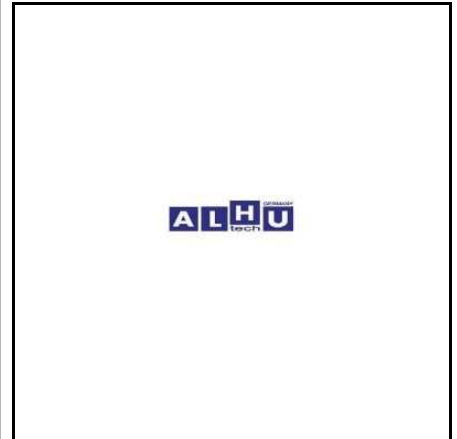

Schalter / Switch

25 545 624 RELAY	
WIPER	
<p>Mercedes Benz 022 545 25 32</p>	<p>MAN 81.25902.0191</p>
<p>Bosch 0 335 320 016</p>	<p>Scania 400151</p>



25 545 214 REVERSE LIGHT SWITCH	
<p>Mercedes Benz 000 545 52 14</p>	



25 545 414 REVERSE LIGHT SWITCH	
<p>Mercedes Benz 000 545 54 14</p>	<p>Bosch 0 263 300 630</p>
<p>TA501 679.001.1003</p>	



25 545 490 REVERSE LIGHT SWITCH	
<p>Mercedes Benz 000 545 49 09</p>	



Schalter / Switch

25 545 614 REVERSE LIGHT SWITCH

Mercedes Benz
003 545 16 14

ZF
0501 311 807

Scania
1303472



25 545 714 REVERSE LIGHT SWITCH

Mercedes Benz
001 545 76 14

ZF
0501 203 944

MAN
81.27421.0056

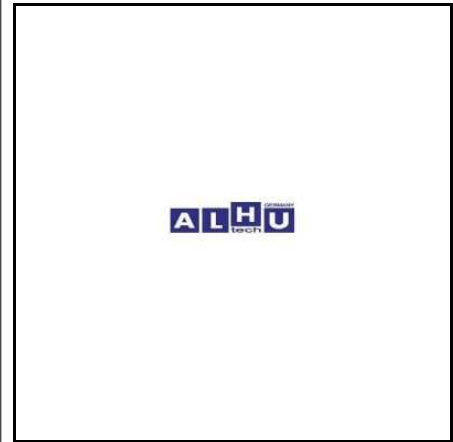

25 545 814 REVERSE LIGHT SWITCH

F 2000 TGA TGX

Mercedes Benz
001 545 47 14

Scania
1303471
1541086

MAN
81.25505.0636



25 546 714 REVERSE LIGHT SWITCH

Mercedes Benz
000 545 87 14

ZF
0501 303 817



Schalter / Switch

25 546 814 REVERSE LIGHT SWITCH

Mercedes Benz
001 545 68 14



25 545 407 ROCKER SWITCH

Mercedes Benz
002 545 24 07



21 542 017 SENDER UNIT
FUEL TANK

SK

Mercedes Benz
008 542 80 17



63 450 012 SENDER UNIT

Mercedes Benz
942 542 02 17

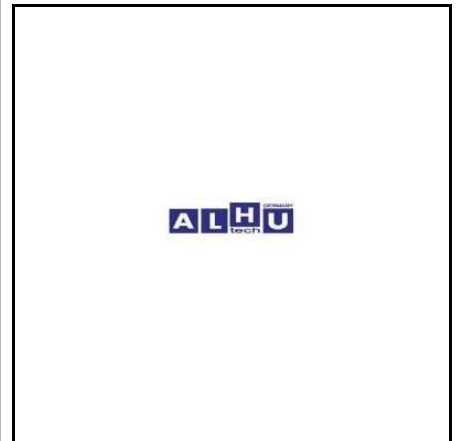

Schalter / Switch

63 450 014 SENDER UNIT

Mercedes Benz
655 542 00 17



21 540 417 SENSOR
water level

Mercedes Benz
002 540 44 17



21 153 520 SPEED SENDER

Mercedes Benz
000 153 95 20



21 542 617 SPEED SENSOR

Mercedes Benz
015 542 24 17

VDO
340-216-005-003



Schalter / Switch

29 545 008 SPEED SENSOR

Mercedes Benz
015 542 27 17



25 545 006 STARTER SWITCH

Mercedes Benz
000 545 37 13

MAN
81.25501.6012

Bosch
0 342 309 008



25 545 105 STARTER SWITCH

Mercedes Benz
000 545 25 13

KHD
1160105

Bosch
0 342 309 006



25 545 914 STARTER SWITCH

Mercedes Benz
001 545 49 14



Schalter / Switch

25 226 045 STEERING COLUMN SWITCH

Mercedes Benz
357 540 00 45



15 226 445 STEERING COLUMN SWITCH

SPRINTER

Mercedes Benz
000 540 74 45
001 540 46 45

VW
2D0 953 503



25 226 039 STEERING COLUMN SWITCH

Mercedes Benz
003 545 83 24

Bosch
0 341 810 009



25 226 124 STEERING COLUMN SWITCH

ACTROS

Mercedes Benz
007 545 82 24
008 545 01 24
008 545 01 24 7C45



Schalter / Switch

25 226 424 STEERING COLUMN SWITCH

Mercedes Benz
005 545 74 24



25 226 681 STEERING COLUMN SWITCH

left hand drive

Mercedes Benz
673 540 04 45



25 226 707 STEERING COLUMN SWITCH

KÄSSBOHRER
7332018000



25 226 727 STEERING COLUMN SWITCH

Mercedes Benz
620 540 00 45



Schalter / Switch

25 226 758 STEERING COLUMN SWITCH

Mercedes Benz
005 545 51 24



25 226 907 STEERING COLUMN SWITCH

Mercedes Benz
655 540 00 45



25 226 921 STEERING COLUMN SWITCH

Mercedes Benz
002 540 62 44

MAN
81.25509.0116



29 545 002 SWITCH

Mercedes Benz
001 545 84 09

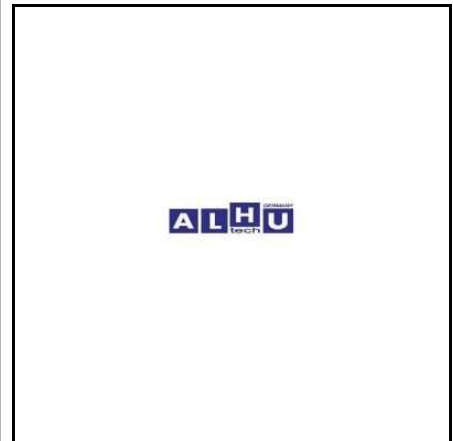

Schalter / Switch

29 545 003 SWITCH

Mercedes Benz
001 545 73 09



29 545 004 SWITCH

Mercedes Benz
001 545 47 09



28 540 545 SWITCH, SHIFT KNOB

ACTROS

Mercedes Benz
941 540 05 45



25 542 305 TEMPERATURE GAUGE

Mercedes Benz
003 542 33 05



Schalter / Switch

21 153 528 TEMPERATURE SENSOR

Mercedes Benz
004 153 25 28

BMW
12 62 1 288 158

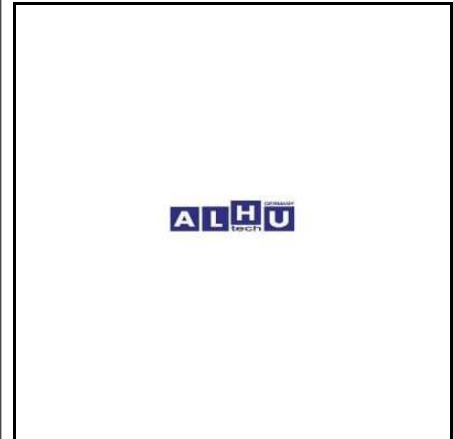

21 542 317 TEMPERATURE SENSOR

Mercedes Benz
001 542 23 17

Scania
309065

BERU
ST 059

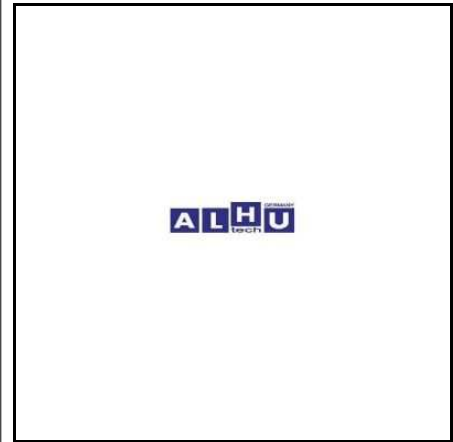

21 542 917 TEMPERATURE SENSOR

100 degrees

Mercedes Benz
002 542 73 17
003 153 90 28
004 542 56 17

MAN
51.27420.0008



29 821 001 TEMPERATURE SENSOR

Mercedes Benz
000 821 00 81

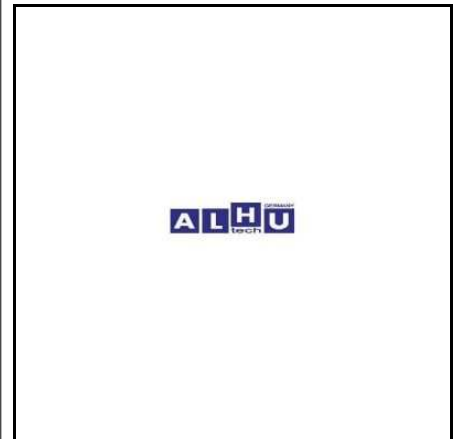

Umschlüsselung / Cross Referenz

AL-HU TECH	DB	Description	Page
616701	355 353 18 62	THRUST WASHER	89
616702	355 353 09 35	DRIVE SHAFT	22
616705	355 353 01 76	THRUST WASHER	89
616706	355 353 09 50	KING PIN BUSHING	26
616707	355 353 10 50	KING PIN BUSHING	26
616708	653 353 00 50	BUSH	16
616709	000 264 08 39	THRUST PIECE	201
616710	000 268 11 49	SLIDING BLOCK	200
753158111	941 671 01 20	WEATHERSTRIP	258
AK27501	002 545 21 14	PUSH KEY	383
AM 16X1.5	913 004 01 60 05	HEX LOCK NUT	154
M12 X 35	000 939 01 20 41	STUD 8.8 DIN 939	155
06 501 568	346 423 09 06	BRAKE ANCHOR PLATE	125
10.9M16X1.5X55	000 960 01 62 49	HEX. HEAD SCREW DIN 961	154
11 200 722	000 200 37 22	FAN CLUTCH	309
11 201 522	603 200 05 22	FAN CLUTCH	309
11 201 822	000 200 58 22	FAN CLUTCH	310
11 206 122	000 200 51 22	FAN CLUTCH	310
11 250 115	002 250 18 15	CLUTCH RELEASE BEARING	189
11 831 770	901 500 05 54	CONDENSOR	288
12 018 302	000 010 02 85	OIL CAP	330
12 018 302	000 018 07 02	OIL CAP	330
12 018 302	111 018 03 02	OIL CAP	330
13 540 001	670 540 00 17	BRAKE WEAR INDICATOR	131
13 540 021	901 540 02 17	BRAKE WEAR INDICATOR	132
13 540 021	901 540 03 17	BRAKE WEAR INDICATOR	132
13 540 041	669 540 04 17	BRAKE WEAR INDICATOR	132
13 540 061	460 540 06 17	BRAKE WEAR INDICATOR	132
13 540 062	601 540 06 17	BRAKE WEAR INDICATOR	132
13 540 072	677 540 07 17	BRAKE WEAR INDICATOR	133
13 540 073	669 540 07 17	BRAKE WEAR INDICATOR	133
13 540 081	669 540 08 17	BRAKE WEAR INDICATOR	133
13 540 117	901 540 00 17	BRAKE WEAR INDICATOR	133
13 540 117	901 540 01 17	BRAKE WEAR INDICATOR	133
13 540 131	601 540 13 17	BRAKE WEAR INDICATOR	134
13 540 320	906 540 13 17	BRAKE WEAR INDICATOR	134
13 540 356	356 540 00 17	BRAKE WEAR INDICATOR	134
13 540 517	164 540 10 17	BRAKE WEAR INDICATOR	134
13 540 517	220 540 15 17	BRAKE WEAR INDICATOR	134
13 540 517	639 540 15 17	BRAKE WEAR INDICATOR	134
13 540 817	677 540 08 17	BRAKE WEAR INDICATOR	135
13 540 835	639 540 14 17	BRAKE WEAR INDICATOR	135
13 540 838	906 540 14 17	BRAKE WEAR INDICATOR	135
13 540 838	906 540 15 17	BRAKE WEAR INDICATOR	135
13 540 917	669 540 09 17	BRAKE WEAR INDICATOR	135
13 542 017	435 542 00 17	BRAKE WEAR INDICATOR	136
13 927 001	901 542 08 17	ABS SENSOR	101
13 927 001	901 542 17 17	ABS SENSOR	101
13 927 002	901 542 11 17	ABS SENSOR	101
13 927 003	002 542 38 18	ABS SENSOR	101
14 462 327	901 462 03 79	LOCK CYLINDER	248
15 226 445	000 540 74 45	STEERING COLUMN SWITCH	389
15 226 445	001 540 46 45	STEERING COLUMN SWITCH	389
18 010 001	601 010 04 70	BREATHING PIPE	286

Umschlüsselung / Cross Referenz

AL-HU TECH	DB	Description	Page
18 720 001	211 720 03 46	WINDOW LIFTER	259
18 720 002	211 720 04 46	WINDOW LIFTER	260
18 720 003	211 730 03 46	WINDOW LIFTER	260
18 720 004	211 730 04 46	WINDOW LIFTER	260
18 760 361	901 760 13 61	DOOR HANDLE	224
18 835 285	000 835 22 85	BLOWER MOTOR	204
18 835 301	001 835 83 01	HEAT EXCHANGER	246
18 835 385	000 835 23 85	BLOWER MOTOR	205
18 835 401	002 835 24 01	HEAT EXCHANGER	246
21 000 003	000 326 06 50	STABILIZER BUSHING	68
21 000 004	000 350 06 13	BALL JOINT REPAIR KIT	3
21 000 005	000 996 56 45	BALL JOINT	179
21 000 006	387 323 02 85	STABILIZER BUSHING	68
21 000 007	620 320 01 28	STABILIZER KIT	72
21 000 008	941 241 57 13	RUBBER MOUNTING	35
21 004 003	000 151 51 15	ARMATURE	160
21 004 033	000 151 48 15	ARMATURE	160
21 004 078	000 151 70 55	FIELD COIL	162
21 004 083	000 151 80 55	FIELD COIL	163
21 005 022	000 151 40 15	ARMATURE	160
21 005 025	000 151 39 15	ARMATURE	161
21 005 498	343 151 70 15	STARTER ARMATURE	170
21 006 020	001 151 05 13	STARTER PINION	175
21 010 033	423 010 50 33	TIMING CASE	361
21 010 072	541 010 10 72	OIL DIPSTICK	332
21 010 133	541 010 30 33	TIMING CASE	361
21 010 233	407 015 07 02	TIMING CASE	361
21 010 272	442 010 32 72	OIL DIPSTICK	333
21 010 313	906 010 13 13	OIL PAN	337
21 010 972	457 010 03 72	OIL DIPSTICK	333
21 011 072	422 010 00 72	OIL DIPSTICK	333
21 011 072	442 010 00 72	OIL DIPSTICK	333
21 011 372	403 010 33 72	OIL DIPSTICK	333
21 011 872	422 010 18 72	OIL DIPSTICK	334
21 014 052	000 151 54 14	CARBON BRUSH SET	161
21 014 062	000 151 80 14	CARBON BRUSH SET	161
21 014 063	000 151 79 14	CARBON BRUSH SET	161
21 014 070	000 151 89 14	CARBON BRUSH SET	162
21 014 079	001 151 32 14	CARBON BRUSH SET	162
21 017 003	403 017 02 71	PRESSURE SCREW	343
21 018 335	000 018 13 35	OIL SEPERATOR	340
21 018 535	352 010 01 62	OIL SEPERATOR	340
21 018 536	000 018 58 35	OIL SEPERATOR	341
21 018 635	000 018 57 35	OIL SEPERATOR	341
21 018 735	000 018 37 35	OIL SEPERATOR	341
21 018 835	000 018 38 35	OIL SEPERATOR	340
21 030 020	422 030 04 20	CONROD	289
21 030 021	906 030 02 20	CONROD	290
21 030 022	402 030 30 01	CRANKSHAFT	293
21 030 023	422 030 37 01	CRANKSHAFT	293
21 030 120	407 030 07 20	CONROD	290
21 030 121	906 030 03 20	CONROD	290
21 030 220	442 030 02 20	CONROD	290
21 030 305	457 030 13 05	FLYWHEEL	315

Umschlüsselung / Cross Referenz

AL-HU TECH	DB	Description	Page
21 030 305	457 030 26 05	FLYWHEEL	315
21 030 320	447 030 03 20	CONROD	291
21 030 352	352 030 73 05	FLYWHEEL	315
21 030 353	352 030 39 05	FLYWHEEL	316
21 030 402	403 030 13 05	FLYWHEEL	316
21 030 403	403 030 14 05	FLYWHEEL	316
21 030 420	447 030 04 20	CONROD	291
21 030 441	441 030 04 05	FLYWHEEL	316
21 030 442	442 030 02 05	FLYWHEEL	317
21 030 445	442 030 19 05	FLYWHEEL	317
21 030 447	447 030 18 05	FLYWHEEL	317
21 030 457	457 030 06 05	FLYWHEEL	317
21 030 521	541 030 01 05	FLYWHEEL	318
21 030 620	407 030 06 20	CONROD	291
21 030 720	441 030 08 20	CONROD	291
21 030 820	541 030 05 20	CONROD	292
21 030 905	906 030 19 05	FLYWHEEL	318
21 030 906	906 030 32 05	FLYWHEEL	318
21 030 920	542 030 05 20	CONROD	292
21 031 027	442 031 00 27	CRANKSHAFT RACE	294
21 031 320	904 030 03 20	CONROD	292
21 032 309	403 032 03 09	CRANKSHAFT RACE	294
21 033 019	010 154 91 02	ALTERNATOR	156
21 033 023	010 154 92 02	ALTERNATOR	156
21 040 003	000 090 03 50	FUEL FEED PUMP	320
21 045 056	000 154 46 25	STATOR	176
21 050 025	476 050 00 25	VALVE TAPPET	365
21 050 236	403 050 12 36	ROCKER ARM BRACKET	353
21 050 303	403 050 03 03	CRANKSHAFT GEAR	293
21 050 336	541 050 12 36	ROCKER ARM BRACKET	353
21 050 834	541 050 08 34	ROCKER ARM, EXHAUST	353
21 050 933	541 050 09 33	ROCKER ARM, INLET	353
21 054 101	403 054 18 01	VALVE TAPPET	365
21 054 501	352 054 05 01	VALVE TAPPET	365
21 054 505	541 054 05 05	PUSH ROD	343
21 054 701	906 054 07 01	VALVE TAPPET	366
21 070 009	000 072 29 12	BOOSTER CYLINDER	286
21 072 112	000 072 01 12	AIR CYLINDER	280
21 072 812	000 072 18 12	AIR CYLINDER	280
21 074 515	000 074 05 15	OVERFLOW VALVE	341
21 074 584	000 074 06 84	OVERFLOW VALVE	342
21 074 684	000 074 76 84	OVERFLOW VALVE	342
21 090 050	000 090 60 50	FUEL FEED PUMP	321
21 090 751	000 090 07 51	REPAIR KIT	351
21 090 751	000 092 33 03	REPAIR KIT	351
21 092 330	000 092 33 03	REPAIR KIT for 000 090 6050	352
21 094 001	000 094 82 04	FILTER INSERT	315
21 094 082	371 501 80 82	RADIATOR HOSE	344
21 094 084	000 501 61 82	TURBO HOSE	362
21 094 085	002 094 54 82	TURBO HOSE	362
21 094 086	001 094 26 82	TURBO HOSE	362
21 094 202	010 094 12 02	AIR CLEANER, oil bath	279
21 094 282	002 094 52 82	TURBO HOSE	363
21 094 382	002 094 63 82	TURBO HOSE	363

Umschlüsselung / Cross Referenz

AL-HU TECH	DB	Description	Page
21 094 682	002 094 55 82	TURBO HOSE	363
21 094 682	002 094 66 82	TURBO HOSE	363
21 094 702	016 094 57 02	AIR CLEANER	279
21 094 983	002 094 69 82	TURBO HOSE	363
21 095 182	655 506 00 35	RADIATOR HOSE	345
21 095 282	942 501 05 82	RADIATOR HOSE	345
21 098 183	366 098 01 83	DISCHARGE HOSE	295
21 101 006	000 152 40 10	SOLENOID SWITCH	168
21 114 060	000 151 56 55	FIELD COIL	163
21 114 065	000 151 55 55	FIELD COIL	163
21 114 086	624 356 00 20	HUB CAP	25
21 127 095	000 154 57 16	RECTIFIER ASSY	166
21 127 097	000 154 58 16	RECTIFIER ASSY	167
21 130 008	442 130 00 08	AIR COMPRESSOR PISTON ASSEMBLY	117
21 130 012	000 131 31 50	AIR COMPRESSOR BUSHING	106
21 130 014	541 130 02 14	AIR COMPRESSOR CRANKSHAFT	109
21 130 017	541 131 01 17	AIR COMPRESSOR CONROD	107
21 130 018	442 130 11 20	AIR COMPRESSOR VALVE	120
21 130 019	000 130 26 19	AIR COMPRESSOR CYLINDER HEAD	110
21 130 019	407 130 05 19	AIR COMPRESSOR CYLINDER HEAD	110
21 130 020	447 130 00 14	AIR COMPRESSOR CRANKSHAFT	109
21 130 022	447 132 02 05	AIR COMPRESSOR GEAR	116
21 130 025	000 131 18 17	AIR COMPRESSOR CONROD	107
21 130 026	541 131 06 80	AIR COMPRESSOR GASKET	114
21 130 028	000 130 49 20	AIR COMPRESSOR REPAIR KIT	119
21 130 029	000 130 68 15	AIR COMPRESSOR GASKET SET	115
21 130 031	000 131 42 50	AIR COMPRESSOR BUSHING	106
21 130 032	000 132 14 10	AIR COMPRESSOR FOLLOWER	114
21 130 036	447 131 02 80	AIR COMPRESSOR GASKET	114
21 130 037	442 131 05 19	AIR COMPRESSOR CYLINDER HEAD	111
21 130 041	447 130 00 08	AIR COMPRESSOR PISTON ASSEMBLY	117
21 130 045	403 130 16 45	AIR COMPRESSOR FLANGE	113
21 130 051	403 990 00 10	AIR COMPRESSOR CRANKSHAFT SCRE	110
21 130 052	000 130 19 17	AIR COMPRESSOR PISTON	116
21 130 053	000 131 28 02	AIR COMPRESSOR CYLINDER LINER	113
21 130 056	407 131 05 80	AIR COMPRESSOR GASKET	114
21 130 057	447 130 00 20	AIR COMPRESSOR VALVE PLATE	120
21 130 061	442 130 00 20	AIR COMPRESSOR GASKET KIT	115
21 130 062	000 130 34 17	AIR COMPRESSOR PISTON	116
21 130 067	000 131 24 17	AIR COMPRESSOR CONROD	107
21 130 068	001 131 11 11	AIR COMPRESSOR PISTON RING SET	118
21 130 069	001 130 30 15	AIR COMPRESSOR CYLINDER HEAD	111
21 130 108	441 130 00 08	AIR COMPRESSOR PISTON ASSY	117
21 130 114	442 130 01 14	AIR COMPRESSOR CRANKSHAFT	109
21 130 119	541 131 06 19	AIR COMPRESSOR CYLINDER HEAD	111
21 130 119	541 131 11 19	AIR COMPRESSOR CYLINDER HEAD	111
21 130 120	441 130 02 20	AIR COMPRESSOR REPAIR KIT	119
21 130 132	000 130 13 20	AIR COMPRESSOR REPAIR KIT	119
21 130 142	000 131 51 19	AIR COMPRESSOR CYLINDER HEAD	112
21 130 208	541 130 00 08	AIR COMPRESSOR PISTON ASSY	118
21 130 219	442 130 32 19	AIR COMPRESSOR CYLINDER HEAD	110
21 130 220	402 130 02 20	AIR COMPRESSOR REPAIR KIT	120
21 130 261	001 130 26 15	AIR COMPRESSOR REPAIR KIT	120
21 130 308	541 130 01 08	AIR COMPRESSOR PISTON ASSY	118

Umschlüsselung / Cross Referenz

AL-HU TECH	DB	Description	Page
21 130 319	352 130 03 19	AIR COMPRESSOR CYLINDER HEAD	112
21 130 320	402 130 03 20	AIR COMPRESSOR VALVE PLATE KIT	121
21 130 408	352 130 01 08	AIR COMPRESSOR PISTON ASSY	118
21 130 445	442 130 01 45	AIR COMPRESSOR FLANGE	113
21 130 515	447 130 05 15	AIR COMPRESSOR	105
21 130 608	402 130 06 08	AIR COMPRESSOR PISTON ASSEMBLY	117
21 130 615	000 130 76 15	AIR COMPRESSOR GASKET SET	115
21 130 620	541 130 06 20	AIR COMPRESSOR VALVE PLATE KIT	121
21 130 719	541 130 27 19	AIR COMPRESSOR CYLINDER HEAD	112
21 130 720	442 130 07 20	AIR COMPRESSOR VALVE PLATE KIT	121
21 130 816	403 130 28 16	AIR COMPRESSOR CONROD	108
21 130 820	541 130 08 20	AIR COMPRESSOR VALVE PLATE KIT	279
21 130 919	541 130 29 19	AIR COMPRESSOR CYLINDER HEAD	112
21 130 920	000 130 76 20	AIR COMPRESSOR VALVE PLATE KIT	279
21 131 011	000 131 30 50	AIR COMPRESSOR BUSHING	107
21 131 016	403 131 07 16	AIR COMPRESSOR CRANKSHAFT	109
21 131 116	403 131 10 16	AIR COMPRESSOR CRANKSHAFT	110
21 131 131	541 131 01 31	AIR COMPRESSOR GASKET	115
21 131 142	541 131 01 42	AIR COMPRESSOR FLANGE	113
21 140 016	541 140 00 63	THROTTLE VALVE KIT	359
21 140 016	541 140 01 63	THROTTLE VALVE KIT	359
21 140 036	441 140 03 63	THROTTLE VALVE KIT	359
21 140 046	441 140 04 63	THROTTLE VALVE KIT	360
21 140 046	904 140 00 63	THROTTLE VALVE KIT	360
21 140 066	542 140 00 63	THROTTLE VALVE KIT	360
21 140 096	422 140 09 63	THROTTLE VALVE KIT	360
21 140 186	447 140 01 63	THROTTLE VALVE KIT	360
21 140 459	000 140 03 59	ENGINE BRAKE CYLINDER	142
21 140 459	000 140 08 59	ENGINE BRAKE CYLINDER	142
21 145 298	000 154 26 05	VOLTAGE REGULATOR	177
21 146 050	000 501 45 15	RADIATOR CAP	343
21 146 150	000 501 46 15	RADIATOR CAP	344
21 146 150	000 501 72 15	RADIATOR CAP	344
21 146 250	000 501 53 15	RADIATOR CAP	344
21 146 350	000 501 64 15	RADIATOR CAP	344
21 153 328	004 153 43 28	SENSOR	357
21 153 520	000 153 95 20	SPEED SENDER	387
21 153 528	004 153 25 28	TEMPERATURE SENSOR	393
21 153 928	003 153 89 28	KNOCK SENSOR	144
21 180 015	442 180 00 15	OIL RELIEF VALVE	339
21 180 101	355 180 01 01	OIL PUMP	338
21 180 165	355 180 11 65	OIL COOLER	330
21 180 201	542 180 00 01	OIL PUMP	338
21 180 201	542 180 01 01	OIL PUMP	338
21 180 201	542 180 02 01	OIL PUMP	338
21 180 201	542 180 07 01	OIL PUMP	338
21 180 238	000 180 24 38	OIL FILTER COVER	334
21 180 265	355 180 12 65	OIL COOLER	331
21 180 301	541 180 03 01	OIL PUMP	338
21 180 315	422 180 03 15	OIL RELIEF VALVE	340
21 180 438	403 180 14 38	OIL FILTER HEAD	334
21 180 501	423 180 05 01	OIL PUMP	339
21 180 501	423 180 25 01	OIL PUMP	339
21 180 543	442 180 05 43	OIL NOZZLE	336

Umschlüsselung / Cross Referenz

AL-HU TECH	DB	Description	Page
21 180 701	403 180 17 01	OIL PUMP	339
21 180 715	541 180 07 15	PRESSURE RELIEF VALVE	343
21 180 801	403 180 28 01	OIL PUMP	339
21 180 938	403 180 39 38	OIL FILTER HEAD	335
21 184 028	541 184 02 08	COVER, OIL FILTER	293
21 188 001	001 188 31 01	OIL COOLER	331
21 188 201	541 188 02 01	OIL COOLER	331
21 188 301	002 188 43 01	OIL COOLER	331
21 188 401	422 188 01 01	OIL COOLER	332
21 188 501	422 188 00 01	OIL COOLER	332
21 188 801	001 188 88 01	OIL COOLER	332
21 192 004	002 154 05 06	VOLTAGE REGULATOR	177
21 192 005	001 154 88 06	VOLTAGE REGULATOR	177
21 192 006	002 154 39 06	VOLTAGE REGULATOR	178
21 192 014	002 154 96 06	VOLTAGE REGULATOR	178
21 200 001	541 200 10 01	WATER PUMP	368
21 200 001	542 200 20 01	WATER PUMP	368
21 200 001	542 200 24 01	WATER PUMP	368
21 200 003	002 205 97 06	FAN CLUTCH	310
21 200 004	366 200 04 22	FAN CLUTCH	310
21 200 017	353 200 36 01	WATER PUMP	368
21 200 029	541 200 13 22	FAN CLUTCH	311
21 200 030	541 200 15 22	FAN CLUTCH	311
21 200 030	541 200 18 22	FAN CLUTCH	311
21 200 033	000 550 00 33	BELT TENSIONER PULLEY	284
21 200 034	542 200 01 04	WATER PUMP KIT	374
21 200 035	422 200 06 04	WATER PUMP KIT	374
21 200 036	403 200 70 01	WATER PUMP	369
21 200 038	403 200 77 01	WATER PUMP	369
21 200 040	441 200 02 01	WATER PUMP	369
21 200 040	441 200 03 01	WATER PUMP	369
21 200 041	457 200 05 01	WATER PUMP	369
21 200 042	904 200 00 04	WATER PUMP KIT	374
21 200 043	906 200 57 01	WATER PUMP	370
21 200 043	906 200 61 01	WATER PUMP	370
21 200 043	906 200 65 01	WATER PUMP	370
21 200 044	353 200 56 01	WATER PUMP	370
21 200 046	376 200 00 01	WATER PUMP	370
21 200 048	457 200 08 01	WATER PUMP	370
21 200 049	457 200 10 01	WATER PUMP	371
21 200 050	422 200 14 01	WATER PUMP	371
21 200 051	542 200 22 01	WATER PUMP	371
21 200 070	541 200 18 70	BELT TENSIONER	281
21 200 079	403 202 06 10	V-BELT PULLEY	366
21 200 080	403 202 07 10	V-BELT PULLEY	366
21 200 102	403 200 71 01	WATER PUMP	371
21 200 103	542 200 21 01	WATER PUMP	372
21 200 170	541 200 11 70	BELT TENSIONER	281
21 200 201	541 200 12 01	WATER PUMP	372
21 200 202	403 200 73 01	WATER PUMP	372
21 200 215	611 200 02 15	THERMOSTAT HOUSING	358
21 200 215	611 200 07 15	THERMOSTAT HOUSING	358
21 200 222	000 200 82 22	FAN CLUTCH	311
21 200 322	000 200 42 22	FAN CLUTCH	311

Umschlüsselung / Cross Referenz

AL-HU TECH	DB	Description	Page
21 200 322	000 200 83 22	FAN CLUTCH	311
21 200 401	904 200 25 01	WATER PUMP	372
21 200 401	904 200 49 01	WATER PUMP	372
21 200 422	000 200 46 22	FAN CLUTCH	312
21 200 433	000 550 04 33	BELT TENSIONER PULLEY	285
21 200 470	906 200 20 70	BELT TENSIONER	281
21 200 501	403 200 75 01	WATER PUMP	373
21 200 501	422 200 12 01	WATER PUMP	373
21 200 522	904 200 08 22	FAN CLUTCH	312
21 200 570	457 200 14 70	BELT TENSIONER	281
21 200 570	457 200 22 70	BELT TENSIONER	281
21 200 571	000 200 15 70	BELT TENSIONER	282
21 200 572	457 200 16 70	BELT TENSIONER	282
21 200 573	457 200 31 70	BELT TENSIONER	282
21 200 574	906 200 12 70	BELT TENSIONER	282
21 200 575	906 200 22 70	BELT TENSIONER	283
21 200 579	541 200 15 70	BELT TENSIONER	283
21 200 582	906 200 18 70	BELT TENSIONER	283
21 200 586	000 550 06 33	BELT TENSIONER PULLEY	285
21 200 590	541 200 23 70	BELT TENSIONER	283
21 200 591	457 200 17 70	BELT TENSIONER	284
21 200 591	457 200 34 70	BELT TENSIONER	284
21 200 601	422 200 11 01	WATER PUMP	373
21 200 622	000 200 67 22	FAN CLUTCH	312
21 200 670	457 200 21 70	BELT TENSIONER	284
21 200 722	000 200 81 22	FAN CLUTCH	312
21 200 822	906 200 08 22	FAN CLUTCH	313
21 200 822	906 200 18 22	FAN CLUTCH	313
21 200 901	366 200 59 01	WATER PUMP	373
21 200 902	422 200 10 01	WATER PUMP	373
21 200 926	403 200 09 26	FAN SPACER	314
21 200 971	906 200 44 70	BELT TENSIONER PULLEY	285
21 200 972	906 200 59 70	BELT TENSIONER	284
21 201 422	000 200 84 22	FAN CLUTCH	313
21 201 622	541 200 06 22	FAN CLUTCH	313
21 201 770	442 200 07 70	BELT TENSIONER PULLEY	285
21 203 004	442 070 96 33	INJECTION LINE SET	326
21 203 005	442 070 81 33	INJECTION LINE SET	327
21 203 006	441 070 11 33	INJECTION LINE SET	327
21 203 007	441 070 55 33	INJECTION LINE SET	327
21 203 011	387 553 03 82	CABIN HOSE	214
21 203 014	407 070 01 36	INJECTION LINE SET	327
21 203 015	447 070 21 33	INJECTION LINE SET	328
21 203 026	002 997 92 82	COMPRESSOR HOSE	288
21 203 027	423 180 09 20	OIL LINE	335
21 203 028	422 070 78 33	INJECTION LINE	328
21 203 029	346 070 10 33	INJECTION LINE	328
21 203 030	900 271 05 50 00	HOSE	326
21 204 071	004 203 84 75	THERMOSTAT 71 DEGREES	358
21 204 071	005 203 28 75	THERMOSTAT 71 DEGREES	358
21 204 079	005 203 27 75	THERMOSTAT 79 DEGREES	359
21 204 083	005 203 26 75	THERMOSTAT 83 DEGREES	359
21 205 006	003 205 00 06	FAN BLADE	306
21 205 007	003 205 06 06	FAN BLADE	306

Umschlüsselung / Cross Referenz

AL-HU TECH	DB	Description	Page
21 205 008	906 205 04 06	FAN BLADE	307
21 205 008	906 205 09 06	FAN BLADE	307
21 205 009	003 205 36 06	FAN BLADE	307
21 205 046	904 205 04 06	FAN BLADE	307
21 205 106	003 205 01 06	FAN BLADE	307
21 205 206	003 205 42 06	FAN BLADE	308
21 205 506	002 205 70 06	FAN BLADE	308
21 205 606	002 205 93 06	FAN BLADE	308
21 209 422	000 151 66 13	STARTER PINION	175
21 209 492	000 151 88 13	STARTER PINION	175
21 215 001	386 332 00 62	THRUST WASHER	89
21 219 007	004 151 02 01	ALTERNATOR	156
21 219 007	004 151 32 01	ALTERNATOR	156
21 230 311	541 230 13 11	COMPRESSOR	288
21 230 611	541 230 12 11	COMPRESSOR	288
21 231 002	005 151 20 01	STARTER MOTOR	171
21 231 003	004 151 86 01	STARTER MOTOR	171
21 241 213	941 241 82 13	ENGINE MOUNTING	22
21 241 713	941 241 87 13	ENGINE MOUNTING	23
21 242 013	668 242 00 13	RUBBER MOUNTING	35
21 242 513	668 242 05 13	RUBBER MOUNTING	35
21 250 002	002 250 49 15	CLUTCH RELEASE BEARING	189
21 250 002	003 250 14 15	CLUTCH RELEASE BEARING	189
21 250 014	385 250 00 14	CLUTCH RELEASE SHAFT REP. KIT	192
21 250 105	002 250 51 15	CLUTCH RELEASE BEARING	189
21 250 114	363 250 01 14	CLUTCH RELEASE SHAFT REP. KIT	192
21 250 315	002 250 73 15	CLUTCH RELEASE BEARING	190
21 250 415	002 250 74 15	CLUTCH RELEASE BEARING	190
21 250 615	002 250 72 15	CLUTCH RELEASE BEARING	190
21 250 615	002 250 76 15	CLUTCH RELEASE BEARING	190
21 250 813	650 250 38 13	CLUTCH RELEASE LEVER	191
21 250 815	002 250 78 15	CLUTCH RELEASE BEARING	190
21 250 815	002 250 81 15	CLUTCH RELEASE BEARING	190
21 250 815	002 250 98 15	CLUTCH RELEASE BEARING	190
21 251 513	655 250 15 13	CLUTCH RELEASE LEVER	191
21 252 646	000 252 06 46	CLUTCH REPAIR KIT	192
21 254 006	650 254 00 06	CLUTCH RELEASE AXLE	188
21 254 108	620 254 01 08	RELEASE LEVER	34
21 254 206	655 254 02 06	CLUTCH RELEASE AXLE	188
21 254 214	620 250 02 14	CLUTCH RELEASE SHAFT KIT	191
21 254 314	650 254 00 06 S	CLUTCH RELEASE SHAFT KIT	192
21 254 708	620 254 07 08	CLUTCH RELEASE LEVER	191
21 290 000	001 295 30 06	CLUTCH MASTER CYLINDER	185
21 290 001	002 295 07 06	CLUTCH MASTER CYLINDER	186
21 290 002	002 295 04 06	CLUTCH MASTER CYLINDER	186
21 290 003	001 295 53 06	CLUTCH MASTER CYLINDER	186
21 290 004	000 295 83 07	CLUTCH SLAVE CYLINDER	193
21 290 506	001 295 95 06	CLUTCH MASTER CYLINDER	186
21 300 030	901 300 10 30	ACCELERATION CABLE	278
21 300 304	624 300 03 04	ACCELERATOR PEDAL KIT	278
21 301 015	000 151 40 50	STARTER SHAFT BUSHING	176
21 301 016	000 151 41 50	STARTER SHAFT BUSHING	176
21 301 030	901 300 16 30	ACCELERATION CABLE	278
21 301 030	901 300 17 30	ACCELERATION CABLE	278

Umschlüsselung / Cross Referenz

AL-HU TECH	DB	Description	Page
21 301 043	000 151 35 50	STARTER BUSHING	170
21 311 301	000 154 17 05	VOLTAGE REGULATOR	178
21 311 301	002 154 17 05	VOLTAGE REGULATOR	178
21 311 301	002 154 84 06	VOLTAGE REGULATOR	178
21 320 001	393 320 02 28	STABILIZER KIT	72
21 320 063	346 320 50 63	SPRING SHACKLE	67
21 320 684	389 320 06 84	HUB CAP	25
21 323 001	002 323 15 00	SHOCK ABSORBER	57
21 323 002	002 323 16 00	SHOCK ABSORBER	57
21 323 003	387 326 00 00	SHOCK ABSORBER	57
21 323 004	005 323 95 00	SHOCK ABSORBER	57
21 323 006	006 323 09 00	SHOCK ABSORBER	58
21 323 007	006 323 07 00	SHOCK ABSORBER	58
21 323 008	356 326 07 00	SHOCK ABSORBER	58
21 323 140	395 323 01 40	BRACKET	15
21 323 485	000 323 34 85	RUBBER MOUNTING	36
21 325 050	947 325 00 50	RUBBER MOUNTING	36
21 325 152	389 325 21 52	SPACER WASHER	61
21 325 485	000 325 04 85	RUBBER MOUNTING	36
21 326 000	000 326 17 81	STABILIZER BUSHING	68
21 326 001	000 326 08 81	STABILIZER BUSHING	68
21 326 081	000 326 50 81	STABILIZER MOUNTING	79
21 334 025	389 334 00 25	HUB CAP	25
21 335 002	009 154 02 02	ALTERNATOR	156
21 336 062	346 336 00 62	THRUST WASHER	90
21 337 726	001 152 24 10	SOLENOID SWITCH	168
21 339 010	001 152 32 10	SOLENOID SWITCH	169
21 350 001	000 429 37 95	AIR DRYER CARTRIDGE	122
21 350 001	000 430 09 69	AIR DRYER CARTRIDGE	122
21 350 003	000 429 56 95	AIR DRYER CARTRIDGE	122
21 350 008	000 429 46 95	AIR DRYER CARTRIDGE	122
21 350 443	346 350 04 43	GROOVED NUT	24
21 350 445	346 350 04 45	FLANGE	23
21 353 126	346 353 01 26	NUT	29
21 353 925	346 353 09 25	THREADED RING	88
21 356 001	976 356 11 01	WHEEL HUB	95
21 356 002	942 334 12 01	WHEEL HUB	95
21 356 003	389 334 15 01	WHEEL HUB	96
21 356 004	673 356 12 02	WHEEL HUB	96
21 356 005	346 356 25 01	WHEEL HUB	96
21 356 006	346 356 31 01	WHEEL HUB	96
21 356 007	628 334 00 01	WHEEL HUB	97
21 356 015	000 350 05 35	WHEEL HUB ASSEMBLY	99
21 356 016	943 330 11 25	WHEEL HUB	97
21 356 017	975 330 04 25	WHEEL HUB	97
21 356 028	346 356 29 01	WHEEL HUB	97
21 356 029	624 334 10 01	WHEEL HUB	98
21 356 030	668 350 00 35	WHEEL HUB	98
21 356 032	946 356 02 01	WHEEL HUB	98
21 356 033	946 356 07 01	WHEEL HUB	98
21 356 034	949 334 08 01	WHEEL HUB	99
21 356 036	942 334 14 01	WHEEL HUB	99
21 356 041	970 350 03 35	WHEEL HUB	99
21 356 226	674 356 02 26	GROOVED NUT	24

Umschlüsselung / Cross Referenz

AL-HU TECH	DB	Description	Page
21 367 034	004 151 58 01	STARTER MOTOR	172
21 368 024	004 151 59 01	STARTER MOTOR	172
21 372 001	004 151 94 01	STARTER MOTOR	172
21 372 005	457 151 03 01	STARTER MOTOR	172
21 372 006	005 151 50 01	STARTER MOTOR	173
21 372 006	005 151 64 01	STARTER MOTOR	173
21 372 006	005 151 70 01	STARTER MOTOR	173
21 372 006	006 151 15 01	STARTER MOTOR	173
21 372 006	006 151 69 01	STARTER MOTOR	173
21 372 006	007 151 04 01	STARTER MOTOR	173
21 401 019	004 981 43 05	BALL BEARING	2
21 401 035	002 981 17 05	TAPER ROLLER BEARING	88
21 401 527	000 151 06 33	STARTER CLUTCH	171
21 402 001	000 152 30 10	SOLENOID SWITCH	169
21 402 010	000 152 34 10	SOLENOID SWITCH	169
21 410 001	381 410 02 31	UNIVERSAL JOINT	91
21 410 002	304 410 00 31	UNIVERSAL JOINT	92
21 410 007	337 410 00 31	UNIVERSAL JOINT	92
21 410 007	385 410 01 31	UNIVERSAL JOINT	92
21 416 022	003 151 95 01	STARTER MOTOR	173
21 416 024	003 151 60 01	STARTER MOTOR	173
21 416 040	003 151 67 01	STARTER MOTOR	173
21 416 047	002 151 81 01	STARTER MOTOR	174
21 416 047	003 151 57 01	STARTER MOTOR	174
21 417 001	004 151 61 01	STARTER MOTOR	174
21 417 001	005 151 28 01	STARTER MOTOR	174
21 417 036	003 151 66 01	STARTER MOTOR	174
21 418 012	003 151 56 01	STARTER MOTOR	174
21 430 826	000 430 49 26	AIR CYLINDER	280
21 431 002	004 151 60 01	STARTER MOTOR	175
21 440 001	000 090 73 50	FUEL FEED PUMP	321
21 440 005	000 090 14 50	FUEL FEED PUMP	321
21 440 007	000 091 21 90	FUEL FEED PUMP	321
21 440 011	000 090 22 50	FUEL FEED PUMP	322
21 440 027	000 090 06 50	FUEL FEED PUMP	322
21 440 043	000 090 21 50	FUEL FEED PUMP	322
21 440 071	003 091 27 01	FUEL FEED PUMP	323
21 440 176	000 090 02 50	FUEL FEED PUMP	323
21 440 177	000 090 27 50	FUEL FEED PUMP	323
21 440 238	001 091 73 01	FUEL FEED PUMP	323
21 440 240	000 090 10 50	FUEL FEED PUMP	324
21 440 989	000 090 31 50	FUEL FEED PUMP	324
21 440 996	000 090 11 50	FUEL FEED PUMP	324
21 440 998	000 090 05 50	FUEL FEED PUMP	324
21 447 000	000 091 11 01	HAND PUMP	325
21 447 011	000 090 02 10	REPAIR KIT	351
21 447 016	000 090 01 51	REPAIR KIT	351
21 447 017	000 091 08 40	REPAIR KIT	352
21 447 020	000 090 00 50	HAND PUMP	325
21 447 032	000 090 04 07	REPAIR KIT	352
21 447 045	000 090 88 50	HAND PUMP	325
21 450 001	000 152 42 10	SOLENOID SWITCH	169
21 450 001	000 152 89 10	SOLENOID SWITCH	169
21 460 080	001 460 70 80	STEERING PUMP	274

Umschlüsselung / Cross Referenz

AL-HU TECH	DB	Description	Page
21 460 502	000 466 45 02	OIL RESERVOIR	273
21 460 680	000 460 66 80	STEERING PUMP	274
21 460 701	000 466 67 01	STEERING PUMP	274
21 460 880	003 460 50 80	STEERING PUMP	275
21 463 432	000 463 64 32	STEERING DAMPER	273
21 466 068	000 466 06 68	COVER	269
21 466 267	000 466 08 67	OIL DIPSTICK	273
21 468 053	007 154 92 02	ALTERNATOR	157
21 469 115	009 154 98 02	ALTERNATOR	157
21 469 744	007 154 68 02	ALTERNATOR	157
21 469 796	007 154 81 02	ALTERNATOR	157
21 469 982	009 154 07 02	ALTERNATOR	158
21 470 004	000 477 13 02	WATER SEPARATOR FILTER	376
21 470 469	000 470 04 69	WATER SEPARATOR	375
21 477 508	000 477 45 08	WATER SEPARATOR HEAD	376
21 477 516	000 477 25 16	WATER SEPARATOR BOWL	375
21 489 325	007 154 54 02	ALTERNATOR	158
21 489 728	007 154 90 02	ALTERNATOR	158
21 490 019	942 490 30 19	EXHAUST PIPE	303
21 490 065	673 490 00 65	EXHAUST FLEX METAL TUBE	300
21 490 119	942 490 31 19	EXHAUST PIPE	303
21 490 165	673 490 02 65	EXHAUST FLEX METAL TUBE	300
21 490 219	942 490 20 19	EXHAUST PIPE	303
21 490 319	942 490 36 19	EXHAUST PIPE	304
21 490 365	620 490 03 65	EXHAUST METAL HOSE	302
21 490 465	620 490 04 65	EXHAUST METAL HOSE	302
21 490 565	621 490 00 65	EXHAUST FLEX METAL TUBE 113 MM	301
21 490 665	674 490 00 65	EXHAUST METAL HOSE	303
21 490 765	942 490 22 19	EXHAUST PIPE	304
21 490 819	942 490 28 19	EXHAUST FLEX METAL TUBE	300
21 491 050	541 140 21 03	EXHAUST MANIFOLD	301
21 491 051	541 140 22 03	EXHAUST MANIFOLD	301
21 491 052	541 140 25 03	EXHAUST MANIFOLD	301
21 491 053	541 140 26 03	EXHAUST MANIFOLD	302
21 500 049	000 500 30 49	EXPANSION TANK	304
21 500 050	627 500 00 49	EXPANSION TANK	304
21 500 055	620 505 03 55	FAN SHROUD	314
21 500 101	697 987 01 39	RADIATOR MOUNTING	351
21 500 149	000 500 31 49	EXPANSION TANK	305
21 500 155	620 505 06 55	FAN SHROUD	314
21 500 364	000 500 03 64	FAN BLADE	308
21 500 849	940 501 00 03	EXPANSION TANK	305
21 501 082	000 501 00 82	TURBO HOSE	364
21 501 082	000 501 60 82	TURBO HOSE	364
21 501 083	001 501 22 82	TURBO HOSE	364
21 501 084	024 997 03 82	TURBO HOSE	364
21 501 085	024 997 07 82	TURBO HOSE	364
21 501 382	941 501 03 82	RADIATOR HOSE	345
21 501 582	941 501 05 82	RADIATOR HOSE	345
21 501 782	940 501 07 82	RADIATOR HOSE	346
21 501 982	940 501 09 82	RADIATOR HOSE	346
21 528 082	615 528 00 82	CONNECTION HOSE	289
21 528 091	942 528 00 91	RUBBER BELLOW, AIR INTAKE	354
21 528 182	655 528 01 82	RUBBER BELLOW, AIR INTAKE	354

Umschlüsselung / Cross Referenz

AL-HU TECH	DB	Description	Page
21 528 191	381 528 01 91	RUBBER BELLOW, AIR INTAKE	354
21 528 291	650 528 00 91	RUBBER BELLOW, AIR INTAKE	354
21 528 382	942 528 03 82	RUBBER BELLOW, AIR INTAKE	355
21 528 982	940 528 09 82	RUBBER BELLOW, AIR INTAKE	355
21 540 417	002 540 44 17	SENSOR	387
21 541 303	620 541 03 03	BATTERY COVER	202
21 542 017	008 542 80 17	SENDER UNIT	386
21 542 117	008 542 81 17	SENDER UNIT	356
21 542 317	001 542 23 17	TEMPERATURE SENSOR	393
21 542 517	012 542 05 17	OIL PRESSURE SWITCH	381
21 542 617	015 542 24 17	SPEED SENSOR	387
21 542 917	002 542 73 17	TEMPERATURE SENSOR	393
21 542 917	003 153 90 28	TEMPERATURE SENSOR	393
21 542 917	004 542 56 17	TEMPERATURE SENSOR	393
21 545 008	000 763 14 10	BRAKE LIGHT SWITCH	377
21 545 109	000 545 77 09	BRAKE LIGHT SWITCH	377
21 545 109	001 545 01 09	BRAKE LIGHT SWITCH	377
21 555 001	011 154 86 02	ALTERNATOR	158
21 555 001	013 154 28 02	ALTERNATOR	158
21 555 002	012 154 10 02	ALTERNATOR	159
21 555 004	013 154 29 02	ALTERNATOR	159
21 555 032	013 154 78 02	ALTERNATOR	159
21 586 206	655 254 02 06 S	CLUTCH RELEASE AXLE KIT	189
21 600 315	000 550 16 33	BELT TENSIONER PULLEY	286
21 601 298	650 356 01 80	GASKET	23
21 620 048	355 356 01 26	LOCK RING	29
21 689 535	008 154 78 02	ALTERNATOR	159
21 689 541	011 154 96 02	ALTERNATOR	160
21 830 013	000 830 17 83	FLUID RESERVOIR	315
21 830 054	906 500 00 54	CONDENSOR	289
21 830 154	942 500 00 54	CONDENSOR	289
21 830 154	942 500 01 54	CONDENSOR	289
21 891 005	000 891 10 05	CABIN SHOCK ABSORBER	219
21 891 205	000 891 22 05	CABIN SHOCK ABSORBER	219
21 910 005	006 981 89 10	NEEDLE BEARING	166
21 981 003	011 981 13 05	TAPER ROLLER BEARING	88
21 990 001	659 990 00 01	SCREW	55
21 990 060	389 990 50 60	NUT	29
21 990 501	395 990 05 01	CARDAN BOLT	17
21 994 109	346 994 01 09	LOCK PLATE	29
21 997 065	346 017 01 60	INJECTOR WASHER	329
21 997 348	000 997 53 48	SEAL RING, SEPERATOR	355
21 999 001	422 200 04 04	WATER PUMP KIT	375
21 999 004	541 200 00 04	WATER PUMP KIT	375
22 000 032	617 993 06 10	BRAKE SHOE SPRING	130
22 000 044	346 993 08 10	BRAKE SHOE SPRING	131
22 000 066	000 327 63 25	ECAS SOLENOID VALVE	142
22 001 001	307 420 40 02	BRAKE PIN KIT	128
22 001 002	497 421 00 74	BRAKE SHOE PIN	130
22 010 002	360 420 03 41	REP.KIT BRAKE CAMSHAFT	148
22 010 003	360 420 04 41	REP.KIT BRAKE CAMSHAFT	148
22 010 004	623 421 01 36	BRAKE CAMSHAFT	125
22 010 005	623 421 02 36	BRAKE CAMSHAFT	126
22 010 006	623 423 01 36	BRAKE CAMSHAFT	126

Umschlüsselung / Cross Referenz

AL-HU TECH	DB	Description	Page
22 010 007	623 423 02 36	BRAKE CAMSHAFT	126
22 010 008	305 421 18 36	BRAKE CAMSHAFT	126
22 010 009	305 421 19 36	BRAKE CAMSHAFT	127
22 010 011	000 420 22 82	BRAKE PIN REPAIR KIT	129
22 015 004	001 431 63 06	PRESSURE LIMITER VALVE	145
22 036 000	001 997 61 36	3/2 DIRECTIONAL CONTROL VALVE	201
22 116 075	004 429 63 44	RELAY VALVE	146
22 130 001	447 130 28 15	AIR COMPRESSOR	106
22 130 002	447 130 30 15	AIR COMPRESSOR	106
22 258 089	356 268 00 89	BALL SOCKET, GEARSHIFT LINKAGE	181
22 260 040	620 260 00 40	SHIFT KNOB	197
22 260 357	001 260 63 57	SHIFTING VALVE	199
22 260 457	000 260 14 57	MULTIWAY VALVE	195
22 260 557	001 260 84 57	SHIFTING VALVE	199
22 260 757	001 260 67 57	SPLITTER VALVE	200
22 260 857	001 260 27 57	SHIFTING VALVE	199
22 268 035	310 268 00 35	BUSHING	182
22 268 042	620 268 00 42	SHIFT KNOB	197
22 268 050	352 268 00 50	BUSHING	182
22 268 157	620 268 01 57	COVER	193
22 268 189	000 268 61 89	BALL JOINT	179
22 268 243	314 268 02 43	BUSHING	182
22 268 250	314 268 02 50	BUSHING	183
22 268 289	000 268 62 89	BALL JOINT	179
22 268 335	352 268 03 35	BUSHING	183
22 268 450	352 268 04 50	BUSHING	183
22 268 589	000 268 48 89	BALL JOINT	179
22 268 589	000 268 52 89	BALL JOINT	179
22 268 889	000 268 59 89	BALL SOCKET, GEARSHIFT LINKAGE	181
22 268 989	000 268 69 89	BALL SOCKET, GEARSHIFT LINKAGE	181
22 400 001	001 431 47 06	4-CIRCUIT PROTECTION VALVE	153
22 400 001	002 431 04 06	4-CIRCUIT PROTECTION VALVE	153
22 400 007	002 431 13 06	4-CIRCUIT PROTECTION VALVE	153
22 420 007	000 420 02 76	CALIPER BOLT REPAIR KIT	136
22 420 008	000 423 00 82	CALIPER COVER SET	136
22 420 944	000 420 06 82	REPAIR KIT, BRAKE CALIPER	147
22 420 944	000 420 39 82	REPAIR KIT, BRAKE CALIPER	147
22 421 001	942 421 21 12	BRAKE DISC	127
22 422 010	000 260 47 63	SHIFTING CYLINDER	198
22 422 012	000 260 46 63	SHIFTING CYLINDER	198
22 422 014	000 260 54 63	SHIFTING CYLINDER	198
22 542 717	013 542 67 17	ABS SENSOR	101
22 722 004	003 430 33 81	HAND BRAKE VALVE REPAIR KIT	144
22 996 245	000 996 52 45	BALL JOINT	180
22 996 440	000 996 64 40	BALL JOINT	180
22 996 545	000 996 55 45	BALL JOINT	180
22 996 645	000 996 66 45	BALL JOINT	180
22 996 845	000 996 68 45	BALL JOINT	181
23 201 444	659 420 14 44	DUST COVER	141
23 201 444	659 420 15 44	DUST COVER	141
23 240 117	300 240 01 17	RUBBER MOUNTING	36
23 320 428	620 320 04 28	STABILIZER KIT	72
23 323 081	396 323 00 50	STABILIZER MOUNTING	79
23 323 285	000 322 12 85	STABILIZER MOUNTING	79

Umschlüsselung / Cross Referenz

AL-HU TECH	DB	Description	Page
23 323 285	000 322 32 85	STABILIZER MOUNTING	79
23 323 350	941 323 03 50	STABILIZER BUSHING	69
23 323 351	000 326 26 81	STABILIZER MOUNTING	80
23 323 352	000 323 79 85	STABILIZER MOUNTING	80
23 323 353	941 323 00 50	STABILIZER BUSHING	69
23 323 354	941 241 76 13	RUBBER MOUNTING	37
23 323 355	941 326 00 50	BUSHING	16
23 323 356	941 323 01 50	STABILIZER MOUNTING	80
23 323 357	942 326 00 50	BUSHING	16
23 324 085	675 323 13 85	STABILIZER BUSHING	69
23 324 185	970 323 17 85	STABILIZER BUSHING	69
23 325 219	624 325 02 19	SPRING SEAT	66
23 325 285	000 325 02 85	STABILIZER BUSHING	70
23 325 285	000 325 13 85	STABILIZER BUSHING	70
23 325 319	624 325 03 19	SPRING SEAT	66
23 325 419	625 325 00 19	SPRING SEAT	66
23 325 519	625 325 01 19	SPRING SEAT	66
23 325 596	000 325 05 96	SPRING CUSHION	63
23 325 619	625 325 02 19	SPRING SEAT	67
23 325 719	625 325 03 19	SPRING SEAT	67
23 325 896	000 325 08 96	SPRING CUSHION	63
23 326 085	000 323 81 85	STABILIZER MOUNTING	80
23 326 086	000 326 24 81	STABILIZER MOUNTING	81
23 326 087	322 285 00 82	PROPELLER SHAFT MOUNTING	33
23 326 088	343 586 00 32	BALL JOINT REPAIR KIT	3
23 326 089	346 330 00 19	KING PIN SET	27
23 326 090	387 326 02 81	STABILIZER BUSHING	70
23 326 091	942 504 02 14	RUBBER MOUNTING	37
23 326 092	617 240 02 17	ENGINE MOUNTING	23
23 326 093	000 241 05 13	RUBBER MOUNTING	37
23 326 094	000 321 00 50	RUBBER MOUNTING	37
23 326 094	000 321 03 50	RUBBER MOUNTING	37
23 326 095	000 323 28 85	STABILIZER MOUNTING	81
23 326 096	001 987 53 40	RUBBER MOUNTING	38
23 326 481	000 326 44 81	STABILIZER MOUNTING	81
23 326 681	655 326 05 81	STABILIZER MOUNTING	81
23 327 081	000 326 23 81	STABILIZER BUSHING	70
23 330 003	941 330 01 03	TIE ROD	275
23 330 003	941 330 02 03	TIE ROD	275
23 330 011	000 330 14 11	BALL JOINT REPAIR KIT	3
23 330 019	655 330 00 19	KING PIN SET	27
23 330 035	001 330 01 35	TIE ROD END	275
23 330 103	942 330 04 03	TIE ROD	90
23 330 135	001 330 21 35	TIE ROD END	276
23 330 203	942 330 05 03	TIE ROD	90
23 330 203	942 330 09 03	TIE ROD	90
23 330 303	945 330 02 03	TIE ROD	275
23 330 403	942 330 01 03	TIE ROD	91
23 330 403	942 330 11 03	TIE ROD	91
23 332 011	346 423 00 58	SEAL HOLDER	55
23 333 304	356 333 13 04	CONTROL ARM	268
23 333 304	613 333 01 04	CONTROL ARM	268
23 350 002	000 330 20 11	BALL JOINT REPAIR KIT	4
23 350 006	659 350 13 06	CONTROL ARM	17

Umschlüsselung / Cross Referenz

AL-HU TECH	DB	Description	Page
23 350 007	659 350 39 06	CONTROL ARM	17
23 350 008	659 350 12 06	CONTROL ARM	18
23 350 008	659 350 35 06	CONTROL ARM	18
23 350 014	659 350 27 06	CONTROL ARM	18
23 350 019	658 350 02 06	CONTROL ARM	18
23 350 055	000 350 08 05	BALL JOINT REPAIR KIT	4
23 350 105	945 350 01 05	CONTROL ARM	18
23 350 105	948 350 22 05	CONTROL ARM	18
23 350 105	948 350 25 05	CONTROL ARM	18
23 350 107	000 330 06 11	BALL JOINT REPAIR KIT	4
23 350 109	000 350 05 06	BALL JOINT REPAIR KIT	4
23 350 116	000 330 02 07	BALL JOINT REPAIR KIT	5
23 350 117	000 350 04 13	BALL JOINT REPAIR KIT	5
23 350 119	947 350 01 05	CONTROL ARM	19
23 350 119	947 350 10 05	CONTROL ARM	19
23 350 120	659 350 34 06	CONTROL ARM	19
23 350 122	652 350 03 06	CONTROL ARM	19
23 350 122	653 350 01 06	CONTROL ARM	19
23 350 123	948 350 23 05	CONTROL ARM	19
23 350 124	385 350 00 06	CONTROL ARM	20
23 350 127	948 350 30 05	CONTROL ARM	20
23 350 129	000 350 01 13	BALL JOINT REPAIR KIT	5
23 350 130	000 350 09 05	BALL JOINT REPAIR KIT	5
23 350 131	000 350 25 05	BALL JOINT REPAIR KIT	6
23 350 205	948 350 12 05	CONTROL ARM	20
23 350 206	395 350 12 06	CONTROL ARM	268
23 350 206	659 350 32 06	CONTROL ARM	268
23 350 250	000 350 15 13	BALL JOINT REPAIR KIT	6
23 350 405	944 350 05 05	CONTROL ARM	20
23 350 405	944 350 06 05	CONTROL ARM	20
23 350 405	948 350 04 05	CONTROL ARM	20
23 350 433	000 350 02 13	BALL JOINT REPAIR KIT	6
23 350 433	000 586 14 33	BALL JOINT REPAIR KIT	6
23 350 505	000 350 24 05	BALL JOINT REPAIR KIT	6
23 350 605	000 350 22 05	BALL JOINT REPAIR KIT	7
23 350 705	000 350 21 05	BALL JOINT REPAIR KIT	7
23 350 805	942 350 05 05	CONTROL ARM	21
23 350 805	942 350 08 05	CONTROL ARM	21
23 350 906	000 350 32 05	BALL JOINT REPAIR KIT	7
23 350 908	948 350 24 05	CONTROL ARM	268
23 350 909	000 350 31 05	BALL JOINT REPAIR KIT	7
23 351 105	942 350 11 05	CONTROL ARM	21
23 351 205	658 350 02 05	CONTROL ARM	21
23 351 305	000 350 20 05	BALL JOINT REPAIR KIT	8
23 351 305	000 350 47 05	BALL JOINT REPAIR KIT	8
23 351 405	000 350 36 05	BALL JOINT REPAIR KIT	8
23 351 605	000 350 27 05	BALL JOINT REPAIR KIT	8
23 351 705	000 350 37 05	BALL JOINT REPAIR KIT	8
23 351 805	000 350 19 05	BALL JOINT REPAIR KIT	9
23 351 905	000 350 23 05	BALL JOINT REPAIR KIT	9
23 351 905	000 350 44 05	BALL JOINT REPAIR KIT	9
23 352 005	000 350 48 05	BALL JOINT REPAIR KIT	9
23 352 105	000 350 29 05	BALL JOINT REPAIR KIT	9
23 352 205	000 350 45 05	BALL JOINT REPAIR KIT	10

Umschlüsselung / Cross Referenz

AL-HU TECH	DB	Description	Page
23 352 305	000 350 49 05	BALL JOINT REPAIR KIT	10
23 356 015	946 356 00 15	PRESSURE RING	30
23 356 215	355 356 12 15	PRESSURE RING	31
23 356 415	346 356 14 15	PRESSURE RING	31
23 460 048	001 460 05 48	TIE ROD END	276
23 460 048	001 460 79 48	TIE ROD END	276
23 460 148	000 460 68 48	TIE ROD END	276
23 460 148	001 460 17 48	TIE ROD END	276
23 460 148	001 460 96 48	TIE ROD END	276
23 460 205	002 460 61 05	DRAG LINK	269
23 460 205	002 460 62 05	DRAG LINK	269
23 460 248	001 460 22 48	TIE ROD END	276
23 460 448	001 460 14 48	TIE ROD END	277
23 500 001	000 328 20 30	AIR SPRING VALVE	122
23 500 002	000 328 21 30	AIR SPRING VALVE	123
23 500 002	000 328 37 30	AIR SPRING VALVE	123
23 500 004	000 328 32 30	AIR SPRING VALVE	123
23 500 008	000 328 23 30	AIR SPRING VALVE	123
23 500 011	000 328 45 30	AIR SPRING VALVE	123
23 500 104	000 328 42 30	AIR SPRING VALVE	124
23 500 105	000 328 39 30	AIR SPRING VALVE	124
23 500 600	000 327 21 25	NON-RETURN VALVE	145
23 752 121	003 542 26 18	ECAS HEIGHT SENSOR	141
23 752 808	002 542 31 18	ABS SENSOR	102
23 994 001	000 994 25 45	LOCK	145
24 000 001	004 429 61 44	ABS SOLENOID VALVE	105
24 001 100	000 429 65 44	RELAY VALVE	146
24 001 200	001 429 68 44	RELAY VALVE	146
24 001 200	002 429 92 44	RELAY VALVE	146
24 002 107	000 429 16 31	SHUT-OFF VALVE	149
24 002 200	002 431 48 05	TRAILER CONTROL VALVE	152
24 002 210	002 431 01 05	TRAILER CONTROL VALVE	152
24 013 114	000 434 24 01	ENGINE STOP VALVE	142
24 013 116	000 434 21 01	ENGINE STOP VALVE	143
24 013 200	000 434 38 01	DIRECTIONAL CONTROL VALVE	140
24 051 098	000 260 40 98	GEAR LEVER ACTUATOR	194
24 051 126	001 295 67 06	CLUTCH BOOSTER	137
24 051 137	000 295 00 18	CLUTCH BOOSTER	137
24 051 158	000 295 15 18	CLUTCH BOOSTER	137
24 051 159	000 295 09 18	CLUTCH BOOSTER	137
24 051 164	000 295 13 18	CLUTCH BOOSTER	138
24 051 310	001 295 67 07	CLUTCH BOOSTER	138
24 051 431	000 254 00 47	CLUTCH BOOSTER	138
24 051 441	000 254 04 47	CLUTCH BOOSTER	183
24 051 510	000 295 08 18	CLUTCH BOOSTER	138
24 051 903	000 290 32 67	CLUTCH BOOSTER KIT	139
24 051 906	000 295 06 60	CLUTCH BOOSTER KIT	139
24 051 916	000 290 03 47	CLUTCH BOOSTER KIT	139
24 051 917	000 250 03 62	CLUTCH BOOSTER KIT	139
24 130 010	407 130 06 10	AIR COMPRESSOR HOUSING	116
24 130 916	442 131 00 17	AIR COMPRESSOR CONROD	108
24 130 916	442 131 02 17	AIR COMPRESSOR CONROD	108
24 130 916	541 131 00 17	AIR COMPRESSOR CONROD	108
24 200 901	542 200 19 01	WATER PUMP	374

Umschlüsselung / Cross Referenz

AL-HU TECH	DB	Description	Page
24 200 901	542 200 23 01	WATER PUMP	374
24 300 000	000 430 11 07	REPAIR KIT, UNLOADER VALVE	147
24 300 001	000 432 08 07	DRAIN VALVE	141
24 300 001	000 432 21 07	DRAIN VALVE	141
24 303 473	001 431 00 06	PRESSURE REGULATOR	145
24 303 473	002 431 43 06	PRESSURE REGULATOR	145
24 303 474	003 431 36 06	PRESSURE REGULATOR	146
24 315 080	001 431 83 05	FOOT BRAKE VALVE	143
24 315 080	001 431 89 05	FOOT BRAKE VALVE	143
24 315 080	002 431 81 05	FOOT BRAKE VALVE	143
24 319 080	002 431 06 05	FOOT BRAKE VALVE	143
24 407 060	000 430 23 70	SILENCER	149
24 407 071	000 430 20 70	SILENCER	149
24 410 012	654 411 00 12	PROPELLER SHAFT BEARING	31
24 410 022	395 410 06 22	PROPELLER SHAFT BEARING	32
24 410 022	655 410 00 22	PROPELLER SHAFT BEARING	32
24 410 027	973 411 00 12	PROPELLER SHAFT BEARING	32
24 410 522	381 410 15 22	PROPELLER SHAFT BEARING	32
24 410 622	973 410 00 22	PROPELLER SHAFT BEARING	32
24 410 722	654 410 00 22	PROPELLER SHAFT BEARING	33
24 420 014	000 981 60 31	BEARING BUSH	15
24 420 015	000 981 61 31	JOINT BEARING	26
24 420 019	393 420 25 19	BRAKE SHOE	129
24 420 039	335 420 00 39	BRAKE SHOE PIN KIT	130
24 420 049	307 420 03 39	BRAKE SHOE SLEEVE REPAIR KIT	130
24 420 092	000 420 00 92	SLACK ADJUSTER KIT	151
24 420 238	945 420 03 38	SLACK ADJUSTER	149
24 420 243	346 423 07 52	SPACER	61
24 420 319	659 420 03 19	BRAKE SHOE	129
24 420 338	945 420 02 38	SLACK ADJUSTER	150
24 420 438	945 420 04 38	SLACK ADJUSTER	150
24 420 519	659 420 05 19	BRAKE SHOE	129
24 420 644	659 420 16 44	DUST COVER	141
24 420 644	659 420 17 44	DUST COVER	141
24 420 938	945 420 09 38	SLACK ADJUSTER	150
24 430 026	000 430 60 26	AIR CYLINDER	280
24 460 505	343 460 15 05	DRAG LINK	270
24 460 649	346 460 01 05	DRAG LINK	269
24 460 650	002 460 43 05	DRAG LINK	270
24 460 650	002 460 44 05	DRAG LINK	270
24 460 651	000 460 71 05	DRAG LINK	270
24 462 130	001 462 11 30	STEERING LOCK	257
24 492 008	621 492 00 08	EXHAUST CONNECTING PIECE	299
24 492 018	617 492 00 08	EXHAUST CONNECTING PIECE	299
24 492 208	620 492 02 08	EXHAUST CONNECTING PIECE	299
24 500 006	001 431 78 15	AIR DRYER	121
24 500 006	001 431 81 15	AIR DRYER	121
24 500 020	000 429 29 95	LINE FILTER, COMPRESSOR SYSTEM	144
24 545 013	667 545 00 13	IGNITION SWITCH	247
24 545 508	000 545 95 08	IGNITION SWITCH	247
24 997 073	071 555 11 05 01	EXHAUST CLAMP	296
24 997 085	071 555 11 45 00	EXHAUST CLAMP	297
24 997 590	620 997 04 90	EXHAUST CLAMP 75 MM	298
24 997 690	620 997 05 90	EXHAUST CLAMP 90 MM	298

Umschlüsselung / Cross Referenz

AL-HU TECH	DB	Description	Page
24 997 790	621 997 00 90	EXHAUST CLAMP 100 MM	299
25 000 000	381 290 16 14	CLUTCH PIPE	187
25 000 001	381 290 18 14	CLUTCH PIPE	187
25 000 002	381 290 19 14	CLUTCH PIPE	187
25 000 003	381 290 20 14	CLUTCH PIPE	188
25 000 004	655 290 30 13	CLUTCH HOSE	184
25 000 005	655 290 44 13	CLUTCH HOSE	184
25 215 002	002 544 79 32	INDICATOR RELAY	164
25 215 150	003 544 50 32	INDICATOR RELAY	164
25 215 250	003 544 06 32	INDICATOR RELAY	165
25 215 550	002 544 80 32	INDICATOR RELAY	165
25 226 039	003 545 83 24	STEERING COLUMN SWITCH	389
25 226 045	357 540 00 45	STEERING COLUMN SWITCH	389
25 226 124	007 545 82 24	STEERING COLUMN SWITCH	389
25 226 124	008 545 01 24	STEERING COLUMN SWITCH	389
25 226 124	008 545 01 24 7C45	STEERING COLUMN SWITCH	389
25 226 424	005 545 74 24	STEERING COLUMN SWITCH	390
25 226 681	673 540 04 45	STEERING COLUMN SWITCH	390
25 226 727	620 540 00 45	STEERING COLUMN SWITCH	390
25 226 758	005 545 51 24	STEERING COLUMN SWITCH	391
25 226 907	655 540 00 45	STEERING COLUMN SWITCH	391
25 226 921	002 540 62 44	STEERING COLUMN SWITCH	391
25 250 006	000 254 00 17	ROLLER, CLUTCH FORK	197
25 250 007	620 254 02 07	CLUTCH RELEASE AXLE	188
25 250 010	000 252 03 46	CLUTCH REPAIR KIT	193
25 260 001	385 260 05 63	SHIFTING VALVE	200
25 260 002	385 260 94 33	SHIFTING ROD	199
25 260 003	001 260 02 57	SHIFTING VALVE	200
25 268 097	620 268 00 97	GEAR LEVER BOOT	194
25 290 439	673 290 04 39	ROD, MASTER CYLINDER	197
25 540 347	002 540 23 47	COMBINATION INSTRUMENT	223
25 542 001	009 542 10 17	PULSE GENERATOR	383
25 542 016	001 542 40 16	RPM METER	167
25 542 120	002 542 67 20	HORN 24V, 335 HZ	164
25 542 171	002 542 17 17	OIL PRESSURE SWITCH	381
25 542 206	008 542 22 06	SPEEDOMETER	170
25 542 305	003 542 33 05	TEMPERATURE GAUGE	392
25 542 417	005 542 94 17	OIL PRESSURE SWITCH	381
25 542 431	004 542 43 17	OIL PRESSURE SWITCH	381
25 542 716	001 542 87 16	RPM METER	167
25 542 717	000 542 97 16	TACHOMETER	177
25 542 891	004 542 89 17	OIL PRESSURE SWITCH	382
25 542 902	001 542 99 02	OIL PRESSURE GAUGE	380
25 543 015	000 543 10 15	MODUL	165
25 543 115	000 543 89 15	MODUL	165
25 543 215	000 543 90 15	MODUL	166
25 545 000	000 545 25 08	MAIN BATTERY SWITCH	380
25 545 000	000 545 84 08	MAIN BATTERY SWITCH	380
25 545 006	000 545 37 13	STARTER SWITCH	388
25 545 009	000 545 60 09	EXHAUST BRAKE SWITCH	379
25 545 009	003 545 92 14	EXHAUST BRAKE SWITCH	379
25 545 013	000 545 30 13	IGNITION SWITCH	379
25 545 105	000 545 25 13	STARTER SWITCH	388
25 545 108	667 545 01 08	IGNITION SWITCH	248

Umschlüsselung / Cross Referenz

AL-HU TECH	DB	Description	Page
25 545 214	000 545 52 14	REVERSE LIGHT SWITCH	384
25 545 224	005 545 92 24	HAZARD WARNING SWITCH	379
25 545 401	000 545 84 01	FUSE BOX	163
25 545 407	002 545 24 07	ROCKER SWITCH	386
25 545 413	000 545 54 13	IGNITION SWITCH	380
25 545 414	000 545 54 14	REVERSE LIGHT SWITCH	384
25 545 490	000 545 49 09	REVERSE LIGHT SWITCH	384
25 545 501	000 545 85 01	FUSE BOX	164
25 545 609	001 545 38 09	BRAKE-LIGHT SWITCH	378
25 545 614	003 545 16 14	REVERSE LIGHT SWITCH	385
25 545 624	022 545 25 32	RELAY	384
25 545 690	000 545 69 09	BRAKE LIGHT SWITCH	377
25 545 714	001 545 76 14	REVERSE LIGHT SWITCH	385
25 545 809	000 545 98 09	BRAKE LIGHT SWITCH	378
25 545 814	001 545 47 14	REVERSE LIGHT SWITCH	385
25 545 914	001 545 49 14	STARTER SWITCH	388
25 546 714	000 545 87 14	REVERSE LIGHT SWITCH	385
25 546 814	001 545 68 14	REVERSE LIGHT SWITCH	386
26 000 000	655 553 05 82	CABIN HOSE	214
26 010 130	457 010 01 30	CYLINDER HEAD COVER	294
26 310 173	970 310 01 73	LEVER, CABIN LOCKING	248
26 541 103	941 541 00 03	BATTERY COVER	202
26 541 103	941 541 01 03	BATTERY COVER	202
26 720 079	000 720 00 79	SUPPORT	257
26 720 179	000 720 01 79	SUPPORT	257
26 723 120	941 723 01 20	DOOR CHECK	223
26 760 004	641 760 00 04	CABLE, DOOR CONTROL	222
26 810 814	002 810 08 14	MIRROR BRACKET	250
26 810 914	002 810 09 14	MIRROR BRACKET	250
26 820 021	941 820 10 21	BLINKER LAMP	203
26 824 001	381 824 02 28	WIPER ARM	267
26 860 031	620 586 00 31	REPAIR KIT, CABIN MOUNTING	253
26 890 170	941 890 01 70	CABLE, STORAGE BOX	223
27 350 506	654 350 05 06	CONTROL ARM	21
27 350 706	659 350 27 06	CONTROL ARM	269
28 000 001	407 180 11 38	OIL FILTER HEAD	335
28 000 003	000 094 30 04	FILTER HOUSING	314
28 000 003	31 100 54 113	FILTER HOUSING	314
28 000 004	000 295 17 15	RESERVOIR	196
28 000 005	001 295 60 06	CLUTCH MASTER CYLINDER	187
28 000 017	457 098 33 07	INTERCOOLER PIPE	329
28 000 018	457 203 06 30	INTERCOOLER PIPE	329
28 000 020	541 010 27 33	TIMING CASE	362
28 010 713	541 010 07 13	OIL PAN	337
28 010 813	904 010 38 13	OIL PAN	337
28 011 213	541 010 12 13	OIL PAN	337
28 018 333	541 018 03 33	DIAPHRAGM KIT	295
28 030 002	345 030 02 05	FLYWHEEL	318
28 030 003	364 030 01 05	FLYWHEEL	319
28 030 004	366 030 09 05	FLYWHEEL	319
28 030 005	355 030 13 05	FLYWHEEL	319
28 030 006	327 030 02 11	FLYWHEEL	319
28 030 006	360 030 08 11	FLYWHEEL	319
28 030 008	541 030 03 05	FLYWHEEL	320

Umschlüsselung / Cross Referenz

AL-HU TECH	DB	Description	Page
28 030 022	906 030 20 05	FLYWHEEL	320
28 032 001	403 032 03 05	FLYWHEEL RING GEAR	320
28 055 001	442 055 00 20	ADJUSTING SCREW	278
28 070 646	541 070 06 46	OVERFLOW VALVE	342
28 077 325	000 077 04 25	CLUTCH DISC	287
28 094 255	000 094 12 55	CLIP, AIR FILTER	287
28 200 906	003 205 29 06	FAN BLADE	309
28 202 910	403 202 09 10	V-BELT PULLEY	366
28 240 001	307 240 00 17	ENGINE MOUNTING	296
28 252 784	001 544 92 90	REVERSE LIGHT LENS	254
28 290 093	970 290 00 93	REPAIR KIT	352
28 310 077	387 310 00 77	REPAIR KIT, CABIN MOUNTING	253
28 317 012	940 317 10 12	RUBBER BUFFER, CABIN MOUNTING,	255
28 317 112	940 317 11 12	RUBBER BUFFER, CABIN MOUNTING	254
28 317 212	942 317 20 12	RUBBER BUFFER, CABIN MOUNTING	254
28 317 312	942 317 21 12	RUBBER BUFFER, CABIN MOUNTING	255
28 322 385	000 322 03 85	STABILIZER MOUNTING	82
28 413 010	000 477 03 29	OVERFLOW VALVE	342
28 490 001	387 490 00 41	EXHAUST CLAMP	297
28 490 002	387 490 06 25	EXHAUST CONNECTOR	300
28 500 050	942 500 00 50	STABILIZER BUSHING	70
28 522 067	941 522 00 67	RUBBER FOR FENDER	255
28 522 167	941 522 01 67	RUBBER FOR FENDER	255
28 540 003	001 540 63 70	TAIL LAMP	257
28 540 004	001 540 62 70	TAIL LAMP	258
28 540 545	941 540 05 45	SWITCH, SHIFT KNOB	392
28 544 411	000 544 54 11	SIDE MARKER LAMP	256
28 553 111	000 553 99 01	CABIN PUMP	216
28 553 112	001 553 37 01	CABIN PUMP	217
28 553 113	001 553 36 01	CABIN PUMP	217
28 553 114	001 553 34 01	CABIN PUMP	217
28 553 115	001 553 38 01	CABIN PUMP	217
28 553 116	001 553 41 01	CABIN PUMP	218
28 553 301	001 553 00 01	CABIN PUMP	218
28 553 401	001 553 40 01	CABIN PUMP	218
28 553 405	002 553 10 05	CABIN CYLINDER	209
28 553 505	001 553 42 05	CABIN CYLINDER	210
28 553 605	001 553 43 05	CABIN CYLINDER	210
28 553 705	002 553 92 05	CABIN CYLINDER	210
28 553 801	001 553 59 01	CABIN PUMP	218
28 553 805	001 553 35 05	CABIN CYLINDER	210
28 553 901	000 553 39 01	CABIN PUMP	219
28 553 901	000 553 40 01	CABIN PUMP	219
28 553 901	000 553 69 01	CABIN PUMP	219
28 553 901	000 553 79 01	CABIN PUMP	219
28 553 905	001 553 25 05	CABIN CYLINDER	211
28 553 906	002 553 91 05	CABIN CYLINDER	211
28 553 907	002 553 68 05	CABIN CYLINDER	211
28 554 005	001 553 36 05	CABIN CYLINDER	211
28 554 105	002 553 88 05	CABIN CYLINDER	212
28 554 705	001 553 87 05	CABIN CYLINDER	212
28 618 283	942 310 02 83	CABIN LOCK	215
28 618 383	942 310 03 83	CABIN LOCK	216
28 618 483	942 310 04 83	CABIN LOCK	216

Umschlüsselung / Cross Referenz

AL-HU TECH	DB	Description	Page
28 619 005	000 830 11 18	CABIN FILTER	212
28 619 006	000 830 13 18	CABIN FILTER	212
28 619 006	000 830 34 18	CABIN FILTER	212
28 619 007	000 830 12 18	CABIN FILTER	213
28 619 008	000 830 15 18	CABIN FILTER	213
28 720 066	941 720 00 66	DOOR CONTROL	224
28 720 075	673 720 00 75	HANDLE, INSIDE, SLIDING DOOR	236
28 720 166	941 720 01 66	DOOR CONTROL	224
28 720 216	322 720 02 16	DOOR STOP	232
28 720 246	641 720 02 46	WINDOW LIFTER	260
28 720 346	641 720 03 46	WINDOW LIFTER	261
28 720 446	901 720 14 46	WINDOW LIFTER	261
28 720 535	000 720 65 35	DOOR LOCK	230
28 720 546	901 720 15 46	WINDOW LIFTER	261
28 720 616	000 720 06 16	DOOR TENSIONER	232
28 720 635	000 720 66 35	DOOR LOCK	230
28 720 637	641 720 06 37	DOOR HINGE	229
28 720 646	941 720 04 46	WINDOW LIFTER	261
28 720 735	973 720 07 35	DOOR LOCK	230
28 720 737	641 720 07 37	DOOR HINGE	229
28 720 746	941 720 05 46	WINDOW LIFTER	262
28 720 835	973 720 08 35	DOOR LOCK	231
28 720 846	000 725 00 02	WINDOW LIFTER	262
28 720 946	000 725 01 02	WINDOW LIFTER	262
28 721 135	973 720 01 35	DOOR LOCK	231
28 721 235	973 720 02 35	DOOR LOCK	231
28 721 246	000 720 02 46	WINDOW LIFTER	262
28 721 346	000 720 03 46	WINDOW LIFTER	263
28 722 146	973 720 01 46	WINDOW LIFTER	263
28 722 246	973 720 02 46	WINDOW LIFTER	263
28 722 346	973 720 03 46	WINDOW LIFTER	263
28 722 446	973 720 04 46	WINDOW LIFTER	264
28 723 088	641 723 00 88	DOOR LEVER	230
28 723 088	641 723 00 88 35	DOOR LEVER	230
28 723 201	381 723 02 01	DOOR LOCK	231
28 723 301	381 723 03 01	DOOR LOCK	232
28 725 000	381 725 00 02	WINDOW LIFTER	264
28 725 001	381 725 01 02	WINDOW LIFTER	264
28 725 043	381 725 00 60	WINDOW HANDLE	259
28 725 102	322 725 01 02	WINDOW LIFTER	264
28 725 202	322 725 02 02	WINDOW LIFTER	265
28 725 279	381 725 02 79	DOOR HANDLE	224
28 725 302	322 725 03 02	WINDOW LIFTER	265
28 725 379	381 725 03 79	DOOR HANDLE	225
28 750 351	973 750 03 51	HINGE, BONNET, LEFT	246
28 750 359	901 750 03 59	CABLE ENGINE HOOD	222
28 750 451	973 750 04 51	HINGE, BONNET, RIGHT	247
28 750 484	000 750 04 84	LOCK, BONNET	249
28 760 002	673 760 00 02	WINDOW HANDLE BLACK	259
28 760 003	673 760 00 02	WINDOW HANDLE GREY	259
28 760 047	901 760 10 47	SLIDING UNIT, UPPER RIGHT,	256
28 760 059	381 760 00 59	DOOR HANDLE	225
28 760 061	322 760 00 61	DOOR HANDLE	225
28 760 104	901 760 01 04	CABLE, DOOR CONTROL	222

Umschlüsselung / Cross Referenz

AL-HU TECH	DB	Description	Page
28 760 161	322 760 01 61	DOOR HANDLE	225
28 760 205	670 760 02 05	LOCKING CYLINDER WITH KEYS	249
28 760 259	641 760 02 59	DOOR HANDLE	226
28 760 347	901 760 13 47	SLIDING UNIT, UPPER, RIGHT	256
28 760 359	000 760 13 59	DOOR HANDLE	226
28 760 459	901 760 04 59	HANDLE, DOOR AND SLIDING DOOR	235
28 760 559	641 760 03 59	DOOR HANDLE	226
28 760 659	941 760 05 59	DOOR HANDLE	226
28 760 659S	670 760 02 05	DOOR HANDLE	227
28 760 659S	941 760 05 59	DOOR HANDLE	227
28 760 759	941 760 04 59	DOOR HANDLE	227
28 760 759S	670 760 02 05	DOOR HANDLE	227
28 760 759S	941 760 04 59	DOOR HANDLE	227
28 761 159	943 760 01 59	DOOR HANDLE	227
28 761 259	943 760 02 59	DOOR HANDLE	228
28 761 459	641 760 04 59	DOOR HANDLE	228
28 761 559	641 760 05 59	DOOR HANDLE	228
28 766 043	381 766 00 43	DOOR HANDLE	228
28 766 701	322 766 07 01	DOOR HANDLE	229
28 766 901	670 760 01 59	DOOR HANDLE	229
28 810 012	641 810 00 12	MIRROR BEARING	249
28 810 012	641 810 01 12	MIRROR BEARING	249
28 810 116	381 810 71 16	REARVIEW MIRROR	252
28 810 214	641 810 02 14	MIRROR BRACKET	250
28 810 314	641 810 03 14	MIRROR BRACKET	250
28 810 316	314 810 13 16	REARVIEW MIRROR	252
28 811 133	001 811 21 33	MIRROR GLASS	251
28 811 207	641 811 02 07	MIRROR COVER	251
28 811 326	641 811 03 26	MIRROR CONSOLE	251
28 811 816	381 810 38 16	REARVIEW MIRROR	252
28 820 010	000 821 05 52	DOOR CONTACT SWITCH	379
28 820 042	001 824 30 01	WIPER MOTOR	267
28 820 042	003 820 50 42	WIPER MOTOR	267
28 820 043	005 820 90 42	WINDOW LIFTER MOTOR	265
28 820 044	005 820 91 42	WINDOW LIFTER MOTOR	265
28 820 045	000 820 49 08	WINDOW LIFTER MOTOR	266
28 820 046	000 820 50 08	WINDOW LIFTER MOTOR	266
28 820 161	941 820 61 61	HEAD LAMP	236
28 820 162	940 820 01 61	HEAD LAMP	236
28 820 221	940 820 02 21	BLINKER LAMP	202
28 820 242	004 820 67 42	WIPER MOTOR	267
28 820 261	941 820 62 61	HEAD LAMP	236
28 820 262	940 820 02 61	HEAD LAMP	237
28 820 321	940 820 03 21	BLINKER LAMP	202
28 820 361	941 820 43 61	HEAD LAMP	237
28 820 421	940 820 04 21	BLINKER LAMP	203
28 820 461	941 820 44 61	HEAD LAMP	237
28 820 561	973 820 05 61	HEAD LAMP	237
28 820 590	004 826 25 90	HEAD LAMP GLASS	244
28 820 661	973 820 06 61	HEAD LAMP	238
28 820 690	004 826 26 90	HEAD LAMP GLASS	244
28 820 961	941 820 55 61	HEAD LAMP	238
28 821 061	941 820 56 61	HEAD LAMP	238
28 821 161	941 820 51 61	HEAD LAMP	238

Umschlüsselung / Cross Referenz

AL-HU TECH	DB	Description	Page
28 821 261	941 820 52 61	HEAD LAMP	239
28 821 361	943 820 03 61	HEAD LAMP	239
28 821 461	943 820 04 61	HEAD LAMP	239
28 822 161	973 820 01 61	HEAD LAMP	239
28 822 261	973 820 02 61	HEAD LAMP	240
28 826 056	943 820 00 56	FOG LAMP	233
28 826 156	943 820 01 56	FOG LAMP	233
28 826 161	943 820 01 61	HEAD LAMP	240
28 826 261	943 820 02 61	HEAD LAMP	240
28 826 321	973 820 03 21	BLINKER LAMP	203
28 826 361	941 820 53 61	HEAD LAMP	240
28 826 421	973 820 04 21	BLINKER LAMP	203
28 826 461	941 820 54 61	HEAD LAMP	241
28 826 761	941 820 57 61	HEAD LAMP	241
28 826 861	941 820 58 61	HEAD LAMP	241
28 827 012	641 988 05 35	BUMPER COVER	208
28 827 013	942 505 09 55	FAN SHROUD	232
28 827 014	941 880 00 20	HANDLE	235
28 830 001	003 830 05 08	BLOWER MOTOR	205
28 830 002	002 830 84 08	BLOWER MOTOR	205
28 830 008	000 830 98 08	BLOWER MOTOR	205
28 830 108	001 830 03 08	BLOWER MOTOR	206
28 830 184	001 830 21 84	SOLENOID VALVE	357
28 830 208	001 830 02 08	BLOWER MOTOR	206
28 830 308	000 830 93 08	BLOWER MOTOR	206
28 830 461	641 830 04 61	HEAT EXCHANGER	246
28 830 508	000 830 95 08	BLOWER MOTOR	207
28 830 508	001 830 04 08	BLOWER MOTOR	207
28 830 708	001 830 87 08	BLOWER MOTOR	207
28 830 784	002 830 27 84	SOLENOID VALVE	357
28 830 908	000 820 62 42	BLOWER MOTOR	207
28 835 247	940 835 02 47	CABIN FILTER	213
28 835 747	001 835 07 47	CABIN FILTER	213
28 869 121	000 869 31 21	WINDSHIELD WASHER PUMP	266
28 869 221	000 860 32 26	WINDSHIELD WASHER PUMP	266
28 880 660	322 880 06 60	HOOD CATCH, LOWER	247
28 890 001	942 890 29 19	CABIN SHOCK ABSORBER	220
28 890 053	942 890 28 19	CABIN SHOCK ABSORBER	220
28 890 054	942 890 31 19	CABIN SHOCK ABSORBER	220
28 890 054	943 890 09 19	CABIN SHOCK ABSORBER	220
28 890 389	000 890 23 89	CABIN LOCK	216
28 891 051	387 891 05 51	CABIN SPRING	221
28 891 151	387 891 10 51	CABIN SPRING	221
28 891 251	620 891 00 51	CABIN SPRING	221
28 891 351	620 891 01 51	CABIN SPRING	222
28 891 417	620 891 04 17	CABIN BUSHING	208
28 891 472	941 890 04 72	HANDLE	235
28 891 572	941 890 05 72	HANDLE	235
28 980 264	000 980 90 64	GAS SPRING	234
28 980 464	001 980 84 64	GAS SPRING	234
28 988 260	000 988 32 60	GLOVE BOX LOCK	234
28 988 385	000 988 03 85	LOCK, BATTERY COVER	249
28 988 760	000 988 17 60	GLOVE BOX LOCK	234
28 991 912	000 991 09 12	BOLT	208

Umschlüsselung / Cross Referenz

AL-HU TECH	DB	Description	Page
29 542 819	001 542 48 19	STARTER INTERLOCK	171
29 545 001	000 545 37 04	LIGHT SWITCH	380
29 545 002	001 545 84 09	SWITCH	391
29 545 003	001 545 73 09	SWITCH	392
29 545 004	001 545 47 09	SWITCH	392
29 545 008	015 542 27 17	SPEED SENSOR	388
29 545 009	006 545 11 14	PRESSURE SWITCH	382
29 545 010	004 545 54 14	PRESSURE SWITCH	382
29 545 011	000 153 99 32	OIL PRESSURE SWITCH	382
29 546 001	001 546 54 41	CABLE CONNECTOR	378
29 821 001	000 821 00 81	TEMPERATURE SENSOR	393
58 290 001	005 988 82 78	CLIP	223
61 451 655	001 431 59 06	4-CIRCUIT PROTECTION VALVE	153
63 450 005	000 410 10 10	PROPELLER SHAFT BEARING	33
63 450 005	656 411 00 12	PROPELLER SHAFT BEARING	33
63 450 005	656 411 02 12	PROPELLER SHAFT BEARING	33
63 450 006	381 337 05 11	UNIVERSAL JOINT	92
63 450 007	385 410 02 31	UNIVERSAL JOINT	92
63 450 012	942 542 02 17	SENDER UNIT	386
63 450 014	655 542 00 17	SENDER UNIT	387
63 450 017	000 330 07 28	UNIVERSAL JOINT	93
63 450 020	970 410 00 31	UNIVERSAL JOINT	93
63 450 024	942 890 05 19	SHOCK ABSORBER	58
63 450 025	942 890 02 19	CABIN SHOCK ABSORBER	220
63 450 025	942 890 56 19	CABIN SHOCK ABSORBER	220
63 450 025	942 890 60 19	CABIN SHOCK ABSORBER	220
63 450 025	943 890 39 19	CABIN SHOCK ABSORBER	220
63 450 026	942 890 53 19	SHOCK ABSORBER	59
63 450 027	005 323 60 00	SHOCK ABSORBER	59
63 450 029	005 326 11 00	SHOCK ABSORBER	59
63 450 031	617 326 00 00	SHOCK ABSORBER	59
63 450 032	006 326 01 00	SHOCK ABSORBER	60
63 450 041	005 326 33 00	SHOCK ABSORBER	60
63 450 042	942 890 47 19	SHOCK ABSORBER	60
63 450 051	360 330 06 19	KING PIN SET	27
63 450 052	000 330 00 75	BALL JOINT REPAIR KIT	10
63 450 056	000 410 16 28	UNIVERSAL JOINT	93
63 450 057	656 410 01 31	UNIVERSAL JOINT	93
63 450 063	389 410 33 02	PROPELLER SHAFT	31
63 450 065	357 323 04 00	SHOCK ABSORBER	60
63 450 071	001 330 50 35	PROPELLER SHAFT REP. SET	33
63 450 075	943 351 01 25	U-BOLT	94
63 450 086	000 267 10 59	GUIDE RING	195
63 450 095	004 545 99 14	PUSH BUTTON SWITCH	383
63 450 096	403 077 07 12	DRIVE GEAR	295
63 450 102	385 353 08 35	OUTPUT SHAFT	30
63 450 103	355 353 22 45	DRIVING FLANGE	22
63 450 104	355 353 02 34	SELECTOR FORK	56
63 450 105	346 353 06 55	SHIFT CYLINDER	56
63 450 108	941 820 05 21	BLINKER LAMP	204
63 450 109	941 820 09 21	BLINKER LAMP	204
63 450 112	000 268 21 50	BUSH	182
63 450 131	000 460 52 48	BALL JOINT	268
63 450 132	387 326 01 81	STABILIZER MOUNTING	82

Umschlüsselung / Cross Referenz

AL-HU TECH	DB	Description	Page
63 450 133	941 326 03 50	STABILIZER MOUNTING	82
63 450 144	970 320 00 44	STABILIZER MOUNTING	82
63 450 145	000 826 44 10	HEAD LAMP GLASS	245
63 450 146	000 826 45 10	HEAD LAMP GLASS	245
63 450 147	943 820 06 61	HEAD LAMP	241
63 450 148	943 820 08 61	HEAD LAMP	242
63 450 152	004 429 38 44	RELAY VALVE	147
63 450 170	000 326 32 81	STABILIZER MOUNTING	83
63 450 171	005 820 21 42	WIPER MOTOR	267
63 450 173	003 326 44 00	SHOCK ABSORBER	61
63 450 178	000 350 02 05	BALL JOINT REPAIR KIT	10
63 450 180	943 820 05 61	HEAD LAMP	242
63 450 181	942 317 18 12	CABIN BUSHING	209
63 450 182	943 890 03 19	CABIN SHOCK ABSORBER	221
63 450 187	357 320 15 34	AIR SPRING BASE	2
63 450 188	393 320 10 18	AIR SPRING BASE	2
63 450 189	941 820 33 61	HEAD LAMP	242
63 450 190	941 820 34 61	HEAD LAMP	242
63 450 203	012 542 49 17	SENDER UNIT	356
63 450 206	001 830 27 08	BLOWER MOTOR	207
63 450 207	001 820 39 21	FLASHER LAMP	233
63 450 208	001 820 40 21	FLASHER LAMP	233
63 450 215	357 750 00 50	SNAP LOCK	256
63 450 218	943 820 14 61	HEAD LAMP	243
63 450 219	943 820 15 61	HEAD LAMP	243
63 450 220	000 826 47 10	HEAD LAMP GLASS	245
63 450 221	000 826 46 10	HEAD LAMP GLASS	245
63 450 222	002 544 12 90	TAIL LAMP LENS	258
63 450 222	002 544 36 90	TAIL LAMP LENS	258
63 450 223	002 544 16 90	TAIL LAMP LENS	258
63 450 224	943 820 16 61	HEAD LAMP	243
63 450 225	943 820 17 61	HEAD LAMP	243
63 450 226	943 820 22 61	HEAD LAMP	244
63 450 227	943 820 23 61	HEAD LAMP	244
63 450 259	942 332 00 06	KING PIN	26
63 450 260	301 206 01 13	HUB	326
63 450 261	301 206 00 72	NUT	330
63 450 262	307 206 02 10	V-BELT PULLEY	367
63 450 263	305 205 07 10	V-BELT PULLEY	367
63 450 264	301 205 00 02	SHAFT	357
63 450 265	301 206 01 10	V-BELT PULLEY	367
63 450 266	655 330 00 56	COVER	22
63 450 267	007 993 56 01	REPAIR KIT SPRING	147
63 450 268	000 990 32 60	NUT	30
63 450 269	357 320 15 43	BRACKET	15
63 450 270	357 320 17 43	BRACKET	15
63 450 271	005 990 50 40	SHIM	56
63 450 272	000 423 15 36	BRAKE CAMSHAFT	127
63 450 273	000 423 16 36	BRAKE CAMSHAFT	127
63 450 274	301 206 02 10	V-BELT PULLEY	367
63 450 421	620 323 03 50	STABILIZER BUSHING	71
63 450 422	000 323 39 85	STABILIZER MOUNTING	83
63 450 470	620 891 00 17	CABIN BUSHING	209
63 450 471	389 320 00 65	SPRING PIN KIT	64

Umschlüsselung / Cross Referenz

AL-HU TECH	DB	Description	Page
63 450 472	942 317 23 12	CABIN BUSHING	209
63 450 473	000 326 02 50	STABILIZER BUSHING	71
63 450 474	000 326 09 81	RUBBER MOUNTING	38
63 450 475	621 320 04 28	STABILIZER KIT	73
63 450 476	620 320 06 28	STABILIZER KIT	73
63 450 477	624 320 00 28	STABILIZER KIT	73
63 450 478	360 320 00 41	STABILIZER KIT	73
63 450 480	387 320 01 28	STABILIZER KIT	74
63 450 483	000 350 04 05	BALL JOINT REPAIR KIT	11
63 450 544	942 310 00 49	BUSHING	17
63 450 548	005 429 18 44	CHARGING VALVE	136
63 450 549	357 420 05 38	SLACK ADJUSTER	150
63 450 550	357 420 06 38	SLACK ADJUSTER	151
63 450 551	357 420 07 38	SLACK ADJUSTER	151
63 450 556	001 460 15 05	DRAG LINK	270
63 450 557	001 460 13 05	DRAG LINK	271
63 450 558	001 460 71 05	DRAG LINK	271
63 450 559	001 460 11 05	DRAG LINK	271
63 450 560	949 330 04 03	DRAG LINK	271
63 450 560	949 330 23 03	DRAG LINK	271
63 450 561	949 330 02 03	DRAG LINK	272
63 450 561	949 330 09 03	DRAG LINK	272
63 450 562	944 330 02 03	DRAG LINK	272
63 450 566	387 320 00 28	STABILIZER KIT	74
63 450 567	620 320 00 28	STABILIZER KIT	74
63 450 569	003 430 73 81	HAND BRAKE VALVE	143
63 450 569	003 430 74 81	HAND BRAKE VALVE	143
63 450 573	906 052 14 03	CRANKSHAFT GEAR	294
63 450 574	442 010 06 13	OIL PAN	338
63 450 580	004 429 60 44	SOLENOID VALVE	151
63 450 581	000 323 37 85	STABILIZER BUSHING	71
63 450 582	346 320 01 28	STABILIZER KIT	74
63 450 583	541 180 08 43	OIL NOZZLE	336
63 450 584	000 290 09 11	REPAIR KIT	196
63 450 585	000 260 49 98	REPAIR KIT	196
63 450 638	000 132 07 10	DRIVING DOG	295
63 450 738	380 553 00 82	CABIN HOSE	214
63 450 739	387 553 01 82	CABIN HOSE	214
63 450 740	942 553 01 82	CABIN HOSE	215
63 450 741	620 553 03 82	CABIN HOSE	215
63 450 743	942 553 28 82	CABIN HOSE	215
63 450 754	012 542 47 17	ABS SENSOR	102
63 450 755	000 542 91 18	SENSOR	148
63 450 772	001 153 02 20	ABS SENSOR	102
63 450 773	001 153 04 20	ABS SENSOR	102
63 450 774	380 540 21 81	CONNECTING CABLE	140
63 450 775	380 540 22 81	CONNECTING CABLE	140
63 450 785	000 542 97 18	ABS SENSOR	103
63 450 786	356 540 06 17	ABS SENSOR	103
63 450 787	000 540 34 17	ABS SENSOR	103
63 450 788	002 542 22 18	ABS SENSOR	103
63 450 789	001 542 88 18	ABS SENSOR	104
63 450 790	001 542 84 18	ABS SENSOR	104
63 450 791	003 542 35 18	ABS SENSOR	104

Umschlüsselung / Cross Referenz

AL-HU TECH	DB	Description	Page
63 450 791	004 542 45 18	ABS SENSOR	104
63 450 792	001 542 85 18	ABS SENSOR	104
63 450 792	001 542 89 18	ABS SENSOR	104
63 450 793	003 542 46 18	ABS SENSOR	105
63 450 793	004 542 46 18	ABS SENSOR	105
63 450 794	003 542 45 18	ABS SENSOR	105
63 450 794	004 542 47 18	ABS SENSOR	105
63 450 796	002 542 67 18	ECAS HEIGHT SENSOR	142
63 450 810	001 295 47 06	CLUTCH BOOSTER	184
63 450 816	000 329 08 25	CONTAINER VALVE	140
63 450 822	335 573 00 36	CLUTCH HOSE	184
63 450 824	387 421 00 74	SPRING RETAINING PIN	152
63 450 824	658 421 00 74	SPRING RETAINING PIN	152
63 450 834	387 460 14 05	DRAG LINK	272
63 450 834	387 460 33 05	DRAG LINK	272
63 450 834	647 460 01 05	DRAG LINK	272
63 450 836	000 550 15 07	CABIN PUMP GASKET SET	219
63 450 837	000 323 32 85	STABILIZER MOUNTING	83
63 450 838	000 268 05 42	SHIFT KNOB	198
63 450 839	001 981 39 31	JOINT BEARING	248
63 450 840	001 460 29 05	DRAG LINK	272
63 450 843	385 268 14 74	GEARSHIFT PIN	195
63 450 844	395 320 02 65	SPRING PIN KIT	64
63 450 847	422 035 11 14	INTERMEDIATE PIECE	330
63 450 930	002 431 28 05	TRAILER CONTROL VALVE	152
63 450 987	620 505 00 86	BOOT, FAN SHROUD	208
63 450 988	000 295 17 35	CLUTCH HOSE	185
63 450 989	000 295 39 35	CLUTCH HOSE	185
63 450 990	000 429 73 35	BRAKE HOSE	128
63 450 991	019 997 55 82	STEERING HOSE	273
63 450 992	346 466 01 81	STEERING HOSE	274
63 450 993	346 070 03 35	INJECTION LINE	328
63 450 994	423 070 23 33	INJECTION LINE	329
63 451 066	629 330 00 07	BALL JOINT REPAIR KIT	11
63 451 094	001 430 32 81	HAND BRAKE VALVE	144
63 451 115	307 421 00 74	PIN	30
63 451 133	904 205 01 06	FAN BLADE	309
63 451 146	000 939 01 00 09	STUD 8.8	155
63 451 152	355 353 01 58	SEAL HOLDER	56
63 451 154	000 180 23 38	OIL FILTER COVER	334
63 451 155	000 241 36 13	RUBBER MOUNTING	38
63 451 156	000 295 14 35	CLUTCH HOSE	185
63 451 157	000 322 02 44	RUBBER MOUNTING	38
63 451 158	000 323 09 50	STABILIZER MOUNTING	83
63 451 159	000 323 21 50	STABILIZER MOUNTING	84
63 451 160	000 323 58 85	RUBBER MOUNTING	39
63 451 161	000 323 78 85	RUBBER MOUNTING	39
63 451 162	000 325 06 85	STABILIZER MOUNTING	84
63 451 163	000 326 15 81	STABILIZER MOUNTING	84
63 451 164	000 326 16 81	STABILIZER MOUNTING	84
63 451 165	000 326 51 81	RUBBER MOUNTING	39
63 451 166	000 330 00 80	BALL JOINT REPAIR KIT	11
63 451 167	000 350 05 13	BALL JOINT REPAIR KIT	11
63 451 168	000 350 10 05	BALL JOINT REPAIR KIT	12

Umschlüsselung / Cross Referenz

AL-HU TECH	DB	Description	Page
63 451 169	000 350 12 05	BALL JOINT REPAIR KIT	12
63 451 170	000 350 13 05	BALL JOINT REPAIR KIT	12
63 451 171	000 350 14 05	BALL JOINT REPAIR KIT	12
63 451 172	000 350 15 05	BALL JOINT REPAIR KIT	13
63 451 173	000 350 18 05	BALL JOINT REPAIR KIT	13
63 451 174	000 350 26 05	BALL JOINT REPAIR KIT	13
63 451 175	000 350 40 05	BALL JOINT REPAIR KIT	13
63 451 176	000 350 41 05	BALL JOINT REPAIR KIT	14
63 451 177	000 586 06 32	BALL JOINT REPAIR KIT	14
63 451 178	000 586 10 35	BALL JOINT REPAIR KIT	14
63 451 179	000 996 70 45	BALL JOINT	3
63 451 180	001 987 52 40	RUBBER MOUNTING	39
63 451 181	001 987 71 40	RUBBER MOUNTING	40
63 451 182	002 997 54 52	TURBO HOSE	365
63 451 183	003 981 32 05	BALL BEARING	2
63 451 184	347 504 00 12	RUBBER MOUNTING	40
63 451 185	352 155 06 50	BUSHING	286
63 451 186	352 402 00 71	WHEEL BOLT	94
63 451 187	357 240 04 18	RUBBER MOUNTING	40
63 451 188	360 320 03 41	STABILIZER KIT	75
63 451 189	360 323 00 85	STABILIZER MOUNTING	85
63 451 190	360 323 01 51	SPACER RING	61
63 451 191	360 330 07 19	KING PIN SET	27
63 451 192	363 320 02 28	STABILIZER KIT	75
63 451 193	363 506 02 35	RADIATOR HOSE	346
63 451 194	363 891 06 17	STABILIZER MOUNTING	85
63 451 195	363 891 07 17	STABILIZER MOUNTING	85
63 451 196	381 586 00 31	REPAIR KIT, CABIN MOUNTING	253
63 451 197	385 320 00 65	SPRING PIN KIT	64
63 451 198	387 320 03 28	STABILIZER KIT	75
63 451 199	387 320 05 28	STABILIZER KIT	75
63 451 200	387 323 01 85	STABILIZER MOUNTING	85
63 451 201	387 323 03 85	STABILIZER MOUNTING	86
63 451 202	387 501 15 82	RADIATOR HOSE	346
63 451 203	387 501 16 82	RADIATOR HOSE	347
63 451 204	387 501 17 82	RADIATOR HOSE	347
63 451 205	389 320 01 65	SPRING PIN KIT	65
63 451 206	389 326 00 81	STABILIZER MOUNTING	86
63 451 207	393 326 04 81	STABILIZER MOUNTING	86
63 451 208	395 320 01 65	SPRING PIN KIT	65
63 451 209	457 990 20 01	EXHAUST BOLT	296
63 451 210	615 300 01 04	PEDAL	252
63 451 211	617 320 01 28	STABILIZER KIT	76
63 451 212	617 320 02 28	STABILIZER KIT	76
63 451 213	617 326 00 50	STABILIZER MOUNTING	86
63 451 214	620 268 01 96	GEAR SHIFT BOOT	194
63 451 215	620 310 01 77	REPAIR KIT, CABIN MOUNTING	253
63 451 216	620 320 01 11	STABILIZER KIT	76
63 451 217	620 323 00 50	STABILIZER MOUNTING	87
63 451 218	620 323 02 50	STABILIZER MOUNTING	87
63 451 219	620 501 03 82	RADIATOR HOSE	347
63 451 220	620 501 28 82	RADIATOR HOSE	347
63 451 221	620 506 00 35	RADIATOR HOSE	348
63 451 222	620 506 03 35	RADIATOR HOSE	348

Umschlüsselung / Cross Referenz

AL-HU TECH	DB	Description	Page
63 451 223	620 528 01 82	RADIATOR HOSE	348
63 451 224	621 320 00 11	STABILIZER KIT	76
63 451 225	621 320 01 28	STABILIZER KIT	77
63 451 226	621 320 02 28	STABILIZER KIT	77
63 451 227	621 323 00 85	STABILIZER MOUNTING	87
63 451 228	625 320 01 11	STABILIZER KIT	77
63 451 229	625 320 04 11	STABILIZER KIT	77
63 451 230	625 320 06 11	STABILIZER KIT	78
63 451 231	625 320 07 11	STABILIZER KIT	78
63 451 232	629 330 01 07	BALL JOINT REPAIR KIT	14
63 451 233	631 330 14 49	REPAIR KIT STUB AXLE	34
63 451 234	634 326 00 81	STABILIZER MOUNTING	87
63 451 235	641 811 01 07	MIRROR COVER	251
63 451 236	647 320 00 28	STABILIZER KIT	78
63 451 237	652 320 05 11	STABILIZER KIT	78
63 451 238	652 501 24 82	RADIATOR HOSE	348
63 451 239	653 326 03 81	RUBBER MOUNTING	40
63 451 240	653 326 04 81	STABILIZER BUSHING	71
63 451 241	655 320 01 11	STABILIZER KIT	79
63 451 242	655 326 04 81	STABILIZER BUSHING	72
63 451 243	655 501 04 82	RADIATOR HOSE	349
63 451 244	655 501 12 82	RADIATOR HOSE	349
63 451 245	655 890 29 03	REPAIR KIT, CABIN MOUNTING	254
63 451 246	656 501 14 82	RADIATOR HOSE	349
63 451 247	658 320 00 65	SPRING PIN KIT	65
63 451 248	667 317 00 12	RUBBER MOUNTING	41
63 451 249	667 317 02 36	RUBBER MOUNTING	41
63 451 250	667 320 00 44	RUBBER MOUNTING	41
63 451 251	667 320 00 73	RUBBER MOUNTING	41
63 451 252	667 320 00 77	RUBBER MOUNTING	42
63 451 253	667 323 03 85	RUBBER MOUNTING	42
63 451 254	667 323 04 85	RUBBER MOUNTING	42
63 451 255	667 326 01 81	RUBBER MOUNTING	42
63 451 256	667 326 14 40	RUBBER MOUNTING	43
63 451 257	667 326 14 81	RUBBER MOUNTING	43
63 451 258	670 320 03 44	RUBBER MOUNTING	43
63 451 259	670 320 04 44	RUBBER MOUNTING	43
63 451 260	670 330 02 19	KING PIN SET	28
63 451 261	673 320 00 50	SPRING BUSHING	62
63 451 262	673 320 01 50	SPRING BUSHING	62
63 451 263	673 320 02 50	SPRING BUSHING	62
63 451 264	673 323 03 85	RUBBER MOUNTING	44
63 451 265	673 324 01 50	STABILIZER MOUNTING	88
63 451 266	673 324 04 08	RUBBER MOUNTING	44
63 451 267	673 325 01 44	RUBBER MOUNTING	44
63 451 268	673 325 02 84	RUBBER MOUNTING	44
63 451 269	673 326 06 81	RUBBER MOUNTING	45
63 451 270	673 993 04 10	BRAKE SHOE SPRING	131
63 451 271	674 317 08 12	RUBBER MOUNTING	45
63 451 272	674 325 02 44	RUBBER MOUNTING	45
63 451 273	674 325 03 44	RUBBER MOUNTING	45
63 451 274	674 402 01 71	WHEEL BOLT	94
63 451 275	675 320 00 50	SPRING BUSHING	63
63 451 276	675 320 01 50	SPRING BUSHING	63

Umschlüsselung / Cross Referenz

AL-HU TECH	DB	Description	Page
63 451 277	675 323 04 85	RUBBER MOUNTING	46
63 451 278	675 323 14 85	RUBBER MOUNTING	46
63 451 279	675 323 18 85	RUBBER MOUNTING	46
63 451 280	675 323 19 85	RUBBER MOUNTING	46
63 451 281	675 323 23 85	RUBBER MOUNTING	47
63 451 282	675 324 00 08	RUBBER MOUNTING	47
63 451 283	675 325 01 44	RUBBER MOUNTING	47
63 451 284	675 325 05 85	RUBBER MOUNTING	47
63 451 285	675 326 05 81	RUBBER MOUNTING	48
63 451 286	675 326 09 81	RUBBER MOUNTING	48
63 451 287	675 326 12 81	RUBBER MOUNTING	48
63 451 288	675 330 19 19	KING PIN SET	28
63 451 289	676 323 00 85	RUBBER MOUNTING	48
63 451 290	901 241 25 13	RUBBER MOUNTING	49
63 451 291	901 322 04 19	RUBBER MOUNTING	49
63 451 292	901 322 21 19	RUBBER MOUNTING	49
63 451 293	901 322 22 19	RUBBER MOUNTING	49
63 451 294	901 322 26 19	RUBBER MOUNTING	50
63 451 295	901 323 01 85	RUBBER MOUNTING	50
63 451 296	901 323 02 85	RUBBER MOUNTING	50
63 451 297	901 323 02 88	RUBBER MOUNTING	50
63 451 298	901 325 01 44	RUBBER MOUNTING	51
63 451 299	901 326 00 81	RUBBER MOUNTING	51
63 451 300	901 333 02 14	RUBBER MOUNTING	51
63 451 301	904 323 00 85	RUBBER MOUNTING	51
63 451 302	904 326 08 81	RUBBER MOUNTING	52
63 451 303	904 326 10 81	RUBBER MOUNTING	52
63 451 304	906 323 16 85	RUBBER MOUNTING	52
63 451 305	941 501 07 82	RADIATOR HOSE	349
63 451 306	941 501 12 82	RADIATOR HOSE	350
63 451 307	942 317 22 12	RUBBER MOUNTING	52
63 451 308	942 401 02 71	WHEEL BOLT	95
63 451 309	942 401 03 71	WHEEL BOLT	95
63 451 310	942 490 00 41	EXHAUST CLAMP	297
63 451 311	942 490 01 41	EXHAUST CLAMP	297
63 451 312	942 501 15 82	RADIATOR HOSE	350
63 451 313	942 506 15 35	RADIATOR HOSE	350
63 451 314	942 506 32 35	RADIATOR HOSE	350
63 451 315	942 997 00 90	EXHAUST CLAMP	298
63 451 316	942 997 02 90	EXHAUST CLAMP	298
63 451 317	945 421 00 74	BOLT	125
63 451 318	945 993 00 10	BRAKE SHOE SPRING	131
63 451 319	949 320 00 73	SPRING SHACKLE BUSHING	67
63 451 320	970 260 02 98	REPAIR KIT GEARBOX SHIFT	196
63 451 321	970 317 01 12	RUBBER MOUNTING	53
63 451 322	970 320 01 44	RUBBER MOUNTING	53
63 451 323	970 320 03 44	RUBBER MOUNTING	53
63 451 324	970 323 12 85	RUBBER MOUNTING	53
63 451 325	970 323 14 85	RUBBER MOUNTING	54
63 451 326	970 323 15 85	RUBBER MOUNTING	54
63 451 327	970 323 20 85	RUBBER MOUNTING	54
63 451 328	974 320 00 44	RUBBER MOUNTING	54
63 451 329	974 323 03 85	RUBBER MOUNTING	55
63 451 330	974 328 01 81	RUBBER MOUNTING	55

Umschlüsselung / Cross Referenz

AL-HU TECH	DB	Description	Page
63 451 399	973 820 01 21	BLINKER LAMP	204
63 451 404	002 205 65 06	FAN CLUTCH	313
63 451 405	541 202 01 10	V-BELT PULLEY	368
63 451 406	906 202 09 10	V-BELT PULLEY	368
63 451 407	000 011 00 21	COVER	292
63 451 408	442 140 49 53	EXHAUST BRAKE FLAP	296
63 451 409	904 990 04 12	SCREW	355
63 451 410	002 997 97 90	CLAMP	287
63 451 411	005 997 06 90	CLAMP	287
63 451 412	000 830 13 84	HEATER VALVE	325
63 451 413	000 830 35 84	HEATER VALVE	326
63 451 414	011 542 63 17	SENDER UNIT	356
63 451 415	013 542 71 17	SENDER UNIT	356
63 451 416	542 180 09 22	OIL LINE	336
63 451 417	906 180 17 10	OIL FILTER HOUSING	335
63 451 418	541 180 07 43	OIL NOZZLE	336
63 451 419	942 332 03 62	THRUST WASHER	90
63 451 434	674 500 00 49	EXPANSION TANK	305
63 451 436	000 500 21 49	EXPANSION TANK	305
63 451 437	000 500 22 49	EXPANSION TANK	306
63 451 441	970 500 04 49	EXPANSION TANK	306
63 451 480	000 763 29 10	PRESSURE SWITCH	383
63 451 488	355 330 03 19	KING PIN SET	28
63 451 489	343 330 02 19	KING PIN SET	28
63 451 653	001 154 12 16	RECTIFIER	166
63 451 655	002 260 06 63	GEAR CHANGE SERVO	193
63 451 656	001 260 34 63	GEARSHIFT ACTUATOR	194
63 451 668	624 325 03 10	TRUNNION	91
63 451 669	624 325 01 12	SPRING SADDLE	65
63 451 670	346 353 00 85	GEAR	24
63 451 671	393 330 03 03	TIE ROD	91
63 451 673	385 351 05 72	12-POINT COLLAR NUT	100
63 451 674	000 252 12 45	RELEASE RING	34
63 451 675	307 420 41 02	REP. KIT BRAKE SHOE PIN	148
63 451 676	346 353 01 24	RETAINING WASHER	35
63 451 677	346 353 02 24	WASHER	94
63 451 678	346 353 08 25	THREADED RING	89
63 451 679	346 421 31 06	BRAKE ANCHOR PLATE	125
63 451 680	385 351 06 72	12-POINT COLLAR NUT	100
63 451 681	387 325 00 01	SPRING BRACKET	62
63 451 682	684 325 00 17	HELPER SPRING BRACKET	25
63 451 683	395 312 01 24	SPRING MOUNTING	64
63 451 684	620 295 02 40	BRACKET	16
63 451 686	652 353 00 25	GROOVED NUT	24
63 453 005	541 142 01 80	EXHAUST MANIFOLD GASKET	302
63 453 022	004 153 31 28	AIR PRESSURE SENSOR	377
63 453 022	006 153 14 28	AIR PRESSURE SENSOR	377
63 453 026	001 152 36 10	SOLENOID SWITCH	170
63 453 042	001 154 21 16	RECTIFIER ASSY	167
8.8 M10 X 45	000 931 01 02 64	SCREW DIN 931 8.8	155
8.8 M10 X 80	000 931 01 02 39	SCREW ZINCPLATED DIN 931	155
8.8M12X1.5X30	000 912 01 20 47	CHEESE HEAD SCREW DIN 912	154
8.8M16X1.5X50	000 961 01 60 39	HEX. HEAD SCREW DIN 961	154

Umschlüsselung OEM / Cross Reference OEM

DB	AL-HU TECH	Description	Page
000 010 02 85	12 018 302	OIL CAP	330
000 011 00 21	63 451 407	COVER	292
000 018 07 02	12 018 302	OIL CAP	330
000 018 13 35	21 018 335	OIL SEPERATOR	340
000 018 37 35	21 018 735	OIL SEPERATOR	341
000 018 38 35	21 018 835	OIL SEPARATOR	340
000 018 57 35	21 018 635	OIL SEPERATOR	341
000 018 58 35	21 018 536	OIL SEPERATOR	341
000 072 01 12	21 072 112	AIR CYLINDER	280
000 072 18 12	21 072 812	AIR CYLINDER	280
000 072 29 12	21 070 009	BOOSTER CYLINDER	286
000 074 05 15	21 074 515	OVERFLOW VALVE	341
000 074 06 84	21 074 584	OVERFLOW VALVE	342
000 074 76 84	21 074 684	OVERFLOW VALVE	342
000 077 04 25	28 077 325	CLUTCH DISC	287
000 090 00 50	21 447 020	HAND PUMP	325
000 090 01 51	21 447 016	REPAIR KIT	351
000 090 02 10	21 447 011	REPAIR KIT	351
000 090 02 50	21 440 176	FUEL FEED PUMP	323
000 090 03 50	21 040 003	FUEL FEED PUMP	320
000 090 04 07	21 447 032	REPAIR KIT	352
000 090 05 50	21 440 998	FUEL FEED PUMP	324
000 090 06 50	21 440 027	FUEL FEED PUMP	322
000 090 07 51	21 090 751	REPAIR KIT	351
000 090 10 50	21 440 240	FUEL FEED PUMP	324
000 090 11 50	21 440 996	FUEL FEED PUMP	324
000 090 14 50	21 440 005	FUEL FEED PUMP	321
000 090 21 50	21 440 043	FUEL FEED PUMP	322
000 090 22 50	21 440 011	FUEL FEED PUMP	322
000 090 27 50	21 440 177	FUEL FEED PUMP	323
000 090 31 50	21 440 989	FUEL FEED PUMP	324
000 090 60 50	21 090 050	FUEL FEED PUMP	321
000 090 73 50	21 440 001	FUEL FEED PUMP	321
000 090 88 50	21 447 045	HAND PUMP	325
000 091 08 40	21 447 017	REPAIR KIT	352
000 091 11 01	21 447 000	HAND PUMP	325
000 091 21 90	21 440 007	FUEL FEED PUMP	321
000 092 33 03	21 090 751	REPAIR KIT	351
000 092 33 03	21 092 330	REPAIR KIT for 000 090 6050	352
000 094 12 55	28 094 255	CLIP, AIR FILTER	287
000 094 30 04	28 000 003	FILTER HOUSING	314
000 094 82 04	21 094 001	FILTER INSERT	315
000 130 13 20	21 130 132	AIR COMPRESSOR REPAIR KIT	119
000 130 19 17	21 130 052	AIR COMPRESSOR PISTON	116
000 130 26 19	21 130 019	AIR COMPRESSOR CYLINDER HEAD	110
000 130 34 17	21 130 062	AIR COMPRESSOR PISTON	116
000 130 49 20	21 130 028	AIR COMPRESSOR REPAIR KIT	119
000 130 68 15	21 130 029	AIR COMPRESSOR GASKET SET	115
000 130 76 15	21 130 615	AIR COMPRESSOR GASKET SET	115
000 130 76 20	21 130 920	AIR COMPRESSOR VALVE PLATE KIT	279
000 131 18 17	21 130 025	AIR COMPRESSOR CONROD	107
000 131 24 17	21 130 067	AIR COMPRESSOR CONROD	107
000 131 28 02	21 130 053	AIR COMPRESSOR CYLINDER LINER	113
000 131 30 50	21 131 011	AIR COMPRESSOR BUSHING	107

Umschlüsselung OEM / Cross Reference OEM

DB	AL-HU TECH	Description	Page
000 131 31 50	21 130 012	AIR COMPRESSOR BUSHING	106
000 131 42 50	21 130 031	AIR COMPRESSOR BUSHING	106
000 131 51 19	21 130 142	AIR COMPRESSOR CYLINDER HEAD	112
000 132 07 10	63 450 638	DRIVING DOG	295
000 132 14 10	21 130 032	AIR COMPRESSOR FOLLOWER	114
000 140 03 59	21 140 459	ENGINE BRAKE CYLINDER	142
000 140 08 59	21 140 459	ENGINE BRAKE CYLINDER	142
000 151 06 33	21 401 527	STARTER CLUTCH	171
000 151 35 50	21 301 043	STARTER BUSHING	170
000 151 39 15	21 005 025	ARMATURE	161
000 151 40 15	21 005 022	ARMATURE	160
000 151 40 50	21 301 015	STARTER SHAFT BUSHING	176
000 151 41 50	21 301 016	STARTER SHAFT BUSHING	176
000 151 48 15	21 004 033	ARMATURE	160
000 151 51 15	21 004 003	ARMATURE	160
000 151 54 14	21 014 052	CARBON BRUSH SET	161
000 151 55 55	21 114 065	FIELD COIL	163
000 151 56 55	21 114 060	FIELD COIL	163
000 151 66 13	21 209 422	STARTER PINION	175
000 151 70 55	21 004 078	FIELD COIL	162
000 151 79 14	21 014 063	CARBON BRUSH SET	161
000 151 80 14	21 014 062	CARBON BRUSH SET	161
000 151 80 55	21 004 083	FIELD COIL	163
000 151 88 13	21 209 492	STARTER PINION	175
000 151 89 14	21 014 070	CARBON BRUSH SET	162
000 152 30 10	21 402 001	SOLENOID SWITCH	169
000 152 34 10	21 402 010	SOLENOID SWITCH	169
000 152 40 10	21 101 006	SOLENOID SWITCH	168
000 152 42 10	21 450 001	SOLENOID SWITCH	169
000 152 89 10	21 450 001	SOLENOID SWITCH	169
000 153 95 20	21 153 520	SPEED SENDER	387
000 153 99 32	29 545 011	OIL PRESSURE SWITCH	382
000 154 17 05	21 311 301	VOLTAGE REGULATOR	178
000 154 26 05	21 145 298	VOLTAGE REGULATOR	177
000 154 46 25	21 045 056	STATOR	176
000 154 57 16	21 127 095	RECTIFIER ASSY	166
000 154 58 16	21 127 097	RECTIFIER ASSY	167
000 180 23 38	63 451 154	OIL FILTER COVER	334
000 180 24 38	21 180 238	OIL FILTER COVER	334
000 200 15 70	21 200 571	BELT TENSIONER	282
000 200 37 22	11 200 722	FAN CLUTCH	309
000 200 42 22	21 200 322	FAN CLUTCH	311
000 200 46 22	21 200 422	FAN CLUTCH	312
000 200 51 22	11 206 122	FAN CLUTCH	310
000 200 58 22	11 201 822	FAN CLUTCH	310
000 200 67 22	21 200 622	FAN CLUTCH	312
000 200 81 22	21 200 722	FAN CLUTCH	312
000 200 82 22	21 200 222	FAN CLUTCH	311
000 200 83 22	21 200 322	FAN CLUTCH	311
000 200 84 22	21 201 422	FAN CLUTCH	313
000 241 05 13	23 326 093	RUBBER MOUNTING	37
000 241 36 13	63 451 155	RUBBER MOUNTING	38
000 250 03 62	24 051 917	CLUTCH BOOSTER KIT	139
000 252 03 46	25 250 010	CLUTCH REPAIR KIT	193

Umschlüsselung OEM / Cross Reference OEM

DB	AL-HU TECH	Description	Page
000 252 06 46	21 252 646	CLUTCH REPAIR KIT	192
000 252 12 45	63 451 674	RELEASE RING	34
000 254 00 17	25 250 006	ROLLER, CLUTCH FORK	197
000 254 00 47	24 051 431	CLUTCH BOOSTER	138
000 254 04 47	24 051 441	CLUTCH BOOSTER	183
000 260 14 57	22 260 457	MULTIWAY VALVE	195
000 260 40 98	24 051 098	GEAR LEVER ACTUATOR	194
000 260 46 63	22 422 012	SHIFTING CYLINDER	198
000 260 47 63	22 422 010	SHIFTING CYLINDER	198
000 260 49 98	63 450 585	REPAIR KIT	196
000 260 54 63	22 422 014	SHIFTING CYLINDER	198
000 264 08 39	616709	THRUST PIECE	201
000 267 10 59	63 450 086	GUIDE RING	195
000 268 05 42	63 450 838	SHIFT KNOB	198
000 268 11 49	616710	SLIDING BLOCK	200
000 268 21 50	63 450 112	BUSH	182
000 268 48 89	22 268 589	BALL JOINT	179
000 268 52 89	22 268 589	BALL JOINT	179
000 268 59 89	22 268 889	BALL SOCKET, GEARSHIFT LINKAGE	181
000 268 61 89	22 268 189	BALL JOINT	179
000 268 62 89	22 268 289	BALL JOINT	179
000 268 69 89	22 268 989	BALL SOCKET, GEARSHIFT LINKAGE	181
000 290 03 47	24 051 916	CLUTCH BOOSTER KIT	139
000 290 09 11	63 450 584	REPAIR KIT	196
000 290 32 67	24 051 903	CLUTCH BOOSTER KIT	139
000 295 00 18	24 051 137	CLUTCH BOOSTER	137
000 295 06 60	24 051 906	CLUTCH BOOSTER KIT	139
000 295 08 18	24 051 510	CLUTCH BOOSTER	138
000 295 09 18	24 051 159	CLUTCH BOOSTER	137
000 295 13 18	24 051 164	CLUTCH BOOSTER	138
000 295 14 35	63 451 156	CLUTCH HOSE	185
000 295 15 18	24 051 158	CLUTCH BOOSTER	137
000 295 17 15	28 000 004	RESERVOIR	196
000 295 17 35	63 450 988	CLUTCH HOSE	185
000 295 39 35	63 450 989	CLUTCH HOSE	185
000 295 83 07	21 290 004	CLUTCH SLAVE CYLINDER	193
000 321 00 50	23 326 094	RUBBER MOUNTING	37
000 321 03 50	23 326 094	RUBBER MOUNTING	37
000 322 02 44	63 451 157	RUBBER MOUNTING	38
000 322 03 85	28 322 385	STABILIZER MOUNTING	82
000 322 12 85	23 323 285	STABILIZER MOUNTING	79
000 322 32 85	23 323 285	STABILIZER MOUNTING	79
000 323 09 50	63 451 158	STABILIZER MOUNTING	83
000 323 21 50	63 451 159	STABILIZER MOUNTING	84
000 323 28 85	23 326 095	STABILIZER MOUNTING	81
000 323 32 85	63 450 837	STABILIZER MOUNTING	83
000 323 34 85	21 323 485	RUBBER MOUNTING	36
000 323 37 85	63 450 581	STABILIZER BUSHING	71
000 323 39 85	63 450 422	STABILIZER MOUNTING	83
000 323 58 85	63 451 160	RUBBER MOUNTING	39
000 323 78 85	63 451 161	RUBBER MOUNTING	39
000 323 79 85	23 323 352	STABILIZER MOUNTING	80
000 323 81 85	23 326 085	STABILIZER MOUNTING	80
000 325 02 85	23 325 285	STABILIZER BUSHING	70

Umschlüsselung OEM / Cross Reference OEM

DB	AL-HU TECH	Description	Page
000 325 04 85	21 325 485	RUBBER MOUNTING	36
000 325 05 96	23 325 596	SPRING CUSHION	63
000 325 06 85	63 451 162	STABILIZER MOUNTING	84
000 325 08 96	23 325 896	SPRING CUSHION	63
000 325 13 85	23 325 285	STABILIZER BUSHING	70
000 326 02 50	63 450 473	STABILIZER BUSHING	71
000 326 06 50	21 000 003	STABILIZER BUSHING	68
000 326 08 81	21 326 001	STABILIZER BUSHING	68
000 326 09 81	63 450 474	RUBBER MOUNTING	38
000 326 15 81	63 451 163	STABILIZER MOUNTING	84
000 326 16 81	63 451 164	STABILIZER MOUNTING	84
000 326 17 81	21 326 000	STABILIZER BUSHING	68
000 326 23 81	23 327 081	STABILIZER BUSHING	70
000 326 24 81	23 326 086	STABILIZER MOUNTING	81
000 326 26 81	23 323 351	STABILIZER MOUNTING	80
000 326 32 81	63 450 170	STABILIZER MOUNTING	83
000 326 44 81	23 326 481	STABILIZER MOUNTING	81
000 326 50 81	21 326 081	STABILIZER MOUNTING	79
000 326 51 81	63 451 165	RUBBER MOUNTING	39
000 327 21 25	23 500 600	NON-RETURN VALVE	145
000 327 63 25	22 000 066	ECAS SOLENOID VALVE	142
000 328 20 30	23 500 001	AIR SPRING VALVE	122
000 328 21 30	23 500 002	AIR SPRING VALVE	123
000 328 23 30	23 500 008	AIR SPRING VALVE	123
000 328 32 30	23 500 004	AIR SPRING VALVE	123
000 328 37 30	23 500 002	AIR SPRING VALVE	123
000 328 39 30	23 500 105	AIR SPRING VALVE	124
000 328 42 30	23 500 104	AIR SPRING VALVE	124
000 328 45 30	23 500 011	AIR SPRING VALVE	123
000 329 08 25	63 450 816	CONTAINER VALVE	140
000 330 00 75	63 450 052	BALL JOINT REPAIR KIT	10
000 330 00 80	63 451 166	BALL JOINT REPAIR KIT	11
000 330 02 07	23 350 116	BALL JOINT REPAIR KIT	5
000 330 06 11	23 350 107	BALL JOINT REPAIR KIT	4
000 330 07 28	63 450 017	UNIVERSAL JOINT	93
000 330 14 11	23 330 011	BALL JOINT REPAIR KIT	3
000 330 20 11	23 350 002	BALL JOINT REPAIR KIT	4
000 350 01 13	23 350 129	BALL JOINT REPAIR KIT	5
000 350 02 05	63 450 178	BALL JOINT REPAIR KIT	10
000 350 02 13	23 350 433	BALL JOINT REPAIR KIT	6
000 350 04 05	63 450 483	BALL JOINT REPAIR KIT	11
000 350 04 13	23 350 117	BALL JOINT REPAIR KIT	5
000 350 05 06	23 350 109	BALL JOINT REPAIR KIT	4
000 350 05 13	63 451 167	BALL JOINT REPAIR KIT	11
000 350 05 35	21 356 015	WHEEL HUB ASSEMBLY	99
000 350 06 13	21 000 004	BALL JOINT REPAIR KIT	3
000 350 08 05	23 350 055	BALL JOINT REPAIR KIT	4
000 350 09 05	23 350 130	BALL JOINT REPAIR KIT	5
000 350 10 05	63 451 168	BALL JOINT REPAIR KIT	12
000 350 12 05	63 451 169	BALL JOINT REPAIR KIT	12
000 350 13 05	63 451 170	BALL JOINT REPAIR KIT	12
000 350 14 05	63 451 171	BALL JOINT REPAIR KIT	12
000 350 15 05	63 451 172	BALL JOINT REPAIR KIT	13
000 350 15 13	23 350 250	BALL JOINT REPAIR KIT	6

Umschlüsselung OEM / Cross Reference OEM

DB	AL-HU TECH	Description	Page
000 350 18 05	63 451 173	BALL JOINT REPAIR KIT	13
000 350 19 05	23 351 805	BALL JOINT REPAIR KIT	9
000 350 20 05	23 351 305	BALL JOINT REPAIR KIT	8
000 350 21 05	23 350 705	BALL JOINT REPAIR KIT	7
000 350 22 05	23 350 605	BALL JOINT REPAIR KIT	7
000 350 23 05	23 351 905	BALL JOINT REPAIR KIT	9
000 350 24 05	23 350 505	BALL JOINT REPAIR KIT	6
000 350 25 05	23 350 131	BALL JOINT REPAIR KIT	6
000 350 26 05	63 451 174	BALL JOINT REPAIR KIT	13
000 350 27 05	23 351 605	BALL JOINT REPAIR KIT	8
000 350 29 05	23 352 105	BALL JOINT REPAIR KIT	9
000 350 31 05	23 350 909	BALL JOINT REPAIR KIT	7
000 350 32 05	23 350 906	BALL JOINT REPAIR KIT	7
000 350 36 05	23 351 405	BALL JOINT REPAIR KIT	8
000 350 37 05	23 351 705	BALL JOINT REPAIR KIT	8
000 350 40 05	63 451 175	BALL JOINT REPAIR KIT	13
000 350 41 05	63 451 176	BALL JOINT REPAIR KIT	14
000 350 44 05	23 351 905	BALL JOINT REPAIR KIT	9
000 350 45 05	23 352 205	BALL JOINT REPAIR KIT	10
000 350 47 05	23 351 305	BALL JOINT REPAIR KIT	8
000 350 48 05	23 352 005	BALL JOINT REPAIR KIT	9
000 350 49 05	23 352 305	BALL JOINT REPAIR KIT	10
000 410 10 10	63 450 005	PROPELLER SHAFT BEARING	33
000 410 16 28	63 450 056	UNIVERSAL JOINT	93
000 420 00 92	24 420 092	SLACK ADJUSTER KIT	151
000 420 02 76	22 420 007	CALIPER BOLT REPAIR KIT	136
000 420 06 82	22 420 944	REPAIR KIT, BRAKE CALIPER	147
000 420 22 82	22 010 011	BRAKE PIN REPAIR KIT	129
000 420 39 82	22 420 944	REPAIR KIT, BRAKE CALIPER	147
000 423 00 82	22 420 008	CALIPER COVER SET	136
000 423 15 36	63 450 272	BRAKE CAMSHAFT	127
000 423 16 36	63 450 273	BRAKE CAMSHAFT	127
000 429 16 31	24 002 107	SHUT-OFF VALVE	149
000 429 29 95	24 500 020	LINE FILTER, COMPRESSOR SYSTEM	144
000 429 37 95	21 350 001	AIR DRYER CARTRIDGE	122
000 429 46 95	21 350 008	AIR DRYER CARTRIDGE	122
000 429 56 95	21 350 003	AIR DRYER CARTRIDGE	122
000 429 65 44	24 001 100	RELAY VALVE	146
000 429 73 35	63 450 990	BRAKE HOSE	128
000 430 09 69	21 350 001	AIR DRYER CARTRIDGE	122
000 430 11 07	24 300 000	REPAIR KIT, UNLOADER VALVE	147
000 430 20 70	24 407 071	SILENCER	149
000 430 23 70	24 407 060	SILENCER	149
000 430 49 26	21 430 826	AIR CYLINDER	280
000 430 60 26	24 430 026	AIR CYLINDER	280
000 432 08 07	24 300 001	DRAIN VALVE	141
000 432 21 07	24 300 001	DRAIN VALVE	141
000 434 21 01	24 013 116	ENGINE STOP VALVE	143
000 434 24 01	24 013 114	ENGINE STOP VALVE	142
000 434 38 01	24 013 200	DIRECTIONAL CONTROL VALVE	140
000 460 52 48	63 450 131	BALL JOINT	268
000 460 66 80	21 460 680	STEERING PUMP	274
000 460 68 48	23 460 148	TIE ROD END	276
000 460 71 05	24 460 651	DRAG LINK	270

Umschlüsselung OEM / Cross Reference OEM

DB	AL-HU TECH	Description	Page
000 463 64 32	21 463 432	STEERING DAMPER	273
000 466 06 68	21 466 068	COVER	269
000 466 08 67	21 466 267	OIL DIPSTICK	273
000 466 45 02	21 460 502	OIL RESERVOIR	273
000 466 67 01	21 460 701	STEERING PUMP	274
000 470 04 69	21 470 469	WATER SEPARATOR	375
000 477 03 29	28 413 010	OVERFLOW VALVE	342
000 477 13 02	21 470 004	WATER SEPARATOR FILTER	376
000 477 25 16	21 477 516	WATER SEPARATOR BOWL	375
000 477 45 08	21 477 508	WATER SEPARATOR HEAD	376
000 500 03 64	21 500 364	FAN BLADE	308
000 500 21 49	63 451 436	EXPANSION TANK	305
000 500 22 49	63 451 437	EXPANSION TANK	306
000 500 30 49	21 500 049	EXPANSION TANK	304
000 500 31 49	21 500 149	EXPANSION TANK	305
000 501 00 82	21 501 082	TURBO HOSE	364
000 501 45 15	21 146 050	RADIATOR CAP	343
000 501 46 15	21 146 150	RADIATOR CAP	344
000 501 53 15	21 146 250	RADIATOR CAP	344
000 501 60 82	21 501 082	TURBO HOSE	364
000 501 61 82	21 094 084	TURBO HOSE	362
000 501 64 15	21 146 350	RADIATOR CAP	344
000 501 72 15	21 146 150	RADIATOR CAP	344
000 540 34 17	63 450 787	ABS SENSOR	103
000 540 74 45	15 226 445	STEERING COLUMN SWITCH	389
000 542 91 18	63 450 755	SENSOR	148
000 542 97 16	25 542 717	TACHOMETER	177
000 542 97 18	63 450 785	ABS SENSOR	103
000 543 10 15	25 543 015	MODUL	165
000 543 89 15	25 543 115	MODUL	165
000 543 90 15	25 543 215	MODUL	166
000 544 54 11	28 544 411	SIDE MARKER LAMP	256
000 545 25 08	25 545 000	MAIN BATTERY SWITCH	380
000 545 25 13	25 545 105	STARTER SWITCH	388
000 545 30 13	25 545 013	IGNITION SWITCH	379
000 545 37 04	29 545 001	LIGHT SWITCH	380
000 545 37 13	25 545 006	STARTER SWITCH	388
000 545 49 09	25 545 490	REVERSE LIGHT SWITCH	384
000 545 52 14	25 545 214	REVERSE LIGHT SWITCH	384
000 545 54 13	25 545 413	IGNITION SWITCH	380
000 545 54 14	25 545 414	REVERSE LIGHT SWITCH	384
000 545 60 09	25 545 009	EXHAUST BRAKE SWITCH	379
000 545 69 09	25 545 690	BRAKE LIGHT SWITCH	377
000 545 77 09	21 545 109	BRAKE LIGHT SWITCH	377
000 545 84 01	25 545 401	FUSE BOX	163
000 545 84 08	25 545 000	MAIN BATTERY SWITCH	380
000 545 85 01	25 545 501	FUSE BOX	164
000 545 87 14	25 546 714	REVERSE LIGHT SWITCH	385
000 545 95 08	24 545 508	IGNITION SWITCH	247
000 545 98 09	25 545 809	BRAKE LIGHT SWITCH	378
000 550 00 33	21 200 033	BELT TENSIONER PULLEY	284
000 550 04 33	21 200 433	BELT TENSIONER PULLEY	285
000 550 06 33	21 200 586	BELT TENSIONER PULLEY	285
000 550 15 07	63 450 836	CABIN PUMP GASKET SET	219

Umschlüsselung OEM / Cross Reference OEM

DB	AL-HU TECH	Description	Page
000 550 16 33	21 600 315	BELT TENSIONER PULLEY	286
000 553 39 01	28 553 901	CABIN PUMP	219
000 553 40 01	28 553 901	CABIN PUMP	219
000 553 69 01	28 553 901	CABIN PUMP	219
000 553 79 01	28 553 901	CABIN PUMP	219
000 553 99 01	28 553 111	CABIN PUMP	216
000 586 06 32	63 451 177	BALL JOINT REPAIR KIT	14
000 586 10 35	63 451 178	BALL JOINT REPAIR KIT	14
000 586 14 33	23 350 433	BALL JOINT REPAIR KIT	6
000 720 00 79	26 720 079	SUPPORT	257
000 720 01 79	26 720 179	SUPPORT	257
000 720 02 46	28 721 246	WINDOW LIFTER	262
000 720 03 46	28 721 346	WINDOW LIFTER	263
000 720 06 16	28 720 616	DOOR TENSIONER	232
000 720 65 35	28 720 535	DOOR LOCK	230
000 720 66 35	28 720 635	DOOR LOCK	230
000 725 00 02	28 720 846	WINDOW LIFTER	262
000 725 01 02	28 720 946	WINDOW LIFTER	262
000 750 04 84	28 750 484	LOCK, BONNET	249
000 760 13 59	28 760 359	DOOR HANDLE	226
000 763 14 10	21 545 008	BRAKE LIGHT SWITCH	377
000 763 29 10	63 451 480	PRESSURE SWITCH	383
000 820 49 08	28 820 045	WINDOW LIFTER MOTOR	266
000 820 50 08	28 820 046	WINDOW LIFTER MOTOR	266
000 820 62 42	28 830 908	BLOWER MOTOR	207
000 821 00 81	29 821 001	TEMPERATURE SENSOR	393
000 821 05 52	28 820 010	DOOR CONTACT SWITCH	379
000 826 44 10	63 450 145	HEAD LAMP GLASS	245
000 826 45 10	63 450 146	HEAD LAMP GLASS	245
000 826 46 10	63 450 221	HEAD LAMP GLASS	245
000 826 47 10	63 450 220	HEAD LAMP GLASS	245
000 830 11 18	28 619 005	CABIN FILTER	212
000 830 12 18	28 619 007	CABIN FILTER	213
000 830 13 18	28 619 006	CABIN FILTER	212
000 830 13 84	63 451 412	HEATER VALVE	325
000 830 15 18	28 619 008	CABIN FILTER	213
000 830 17 83	21 830 013	FLUID RESERVOIR	315
000 830 34 18	28 619 006	CABIN FILTER	212
000 830 35 84	63 451 413	HEATER VALVE	326
000 830 93 08	28 830 308	BLOWER MOTOR	206
000 830 95 08	28 830 508	BLOWER MOTOR	207
000 830 98 08	28 830 008	BLOWER MOTOR	205
000 835 22 85	18 835 285	BLOWER MOTOR	204
000 835 23 85	18 835 385	BLOWER MOTOR	205
000 860 32 26	28 869 221	WINDSHIELD WASHER PUMP	266
000 869 31 21	28 869 121	WINDSHIELD WASHER PUMP	266
000 890 23 89	28 890 389	CABIN LOCK	216
000 891 10 05	21 891 005	CABIN SHOCK ABSORBER	219
000 891 22 05	21 891 205	CABIN SHOCK ABSORBER	219
000 912 01 20 47	8.8M12X1.5X30	CHEESE HEAD SCREW DIN 912	154
000 931 01 02 39	8.8 M10 X 80	SCREW ZINCPLATED DIN 931	155
000 931 01 02 64	8.8 M10 X 45	SCREW DIN 931 8.8	155
000 939 01 00 09	63 451 146	STUD 8.8	155
000 939 01 20 41	M12 X 35	STUD 8.8 DIN 939	155

Umschlüsselung OEM / Cross Reference OEM

DB	AL-HU TECH	Description	Page
000 960 01 62 49	10.9M16X1.5X55	HEX. HEAD SCREW DIN 961	154
000 961 01 60 39	8.8M16X1.5X50	HEX. HEAD SCREW DIN 961	154
000 980 90 64	28 980 264	GAS SPRING	234
000 981 60 31	24 420 014	BEARING BUSH	15
000 981 61 31	24 420 015	JOINT BEARING	26
000 988 03 85	28 988 385	LOCK, BATTERY COVER	249
000 988 17 60	28 988 760	GLOVE BOX LOCK	234
000 988 32 60	28 988 260	GLOVE BOX LOCK	234
000 990 32 60	63 450 268	NUT	30
000 991 09 12	28 991 912	BOLT	208
000 994 25 45	23 994 001	LOCK	145
000 996 52 45	22 996 245	BALL JOINT	180
000 996 55 45	22 996 545	BALL JOINT	180
000 996 56 45	21 000 005	BALL JOINT	179
000 996 64 40	22 996 440	BALL JOINT	180
000 996 66 45	22 996 645	BALL JOINT	180
000 996 68 45	22 996 845	BALL JOINT	181
000 996 70 45	63 451 179	BALL JOINT	3
000 997 53 48	21 997 348	SEAL RING, SEPERATOR	355
001 091 73 01	21 440 238	FUEL FEED PUMP	323
001 094 26 82	21 094 086	TURBO HOSE	362
001 130 26 15	21 130 261	AIR COMPRESSOR REPAIR KIT	120
001 130 30 15	21 130 069	AIR COMPRESSOR CYLINDER HEAD	111
001 131 11 11	21 130 068	AIR COMPRESSOR PISTON RING SET	118
001 151 05 13	21 006 020	STARTER PINION	175
001 151 32 14	21 014 079	CARBON BRUSH SET	162
001 152 24 10	21 337 726	SOLENOID SWITCH	168
001 152 32 10	21 339 010	SOLENOID SWITCH	169
001 152 36 10	63 453 026	SOLENOID SWITCH	170
001 153 02 20	63 450 772	ABS SENSOR	102
001 153 04 20	63 450 773	ABS SENSOR	102
001 154 12 16	63 451 653	RECTIFIER	166
001 154 21 16	63 453 042	RECTIFIER ASSY	167
001 154 88 06	21 192 005	VOLTAGE REGULATOR	177
001 188 31 01	21 188 001	OIL COOLER	331
001 188 88 01	21 188 801	OIL COOLER	332
001 260 02 57	25 260 003	SHIFTING VALVE	200
001 260 27 57	22 260 857	SHIFTING VALVE	199
001 260 34 63	63 451 656	GEARSHIFT ACTUATOR	194
001 260 63 57	22 260 357	SHIFTING VALVE	199
001 260 67 57	22 260 757	SPLITTER VALVE	200
001 260 84 57	22 260 557	SHIFTING VALVE	199
001 295 30 06	21 290 000	CLUTCH MASTER CYLINDER	185
001 295 47 06	63 450 810	CLUTCH BOOSTER	184
001 295 53 06	21 290 003	CLUTCH MASTER CYLINDER	186
001 295 60 06	28 000 005	CLUTCH MASTER CYLINDER	187
001 295 67 06	24 051 126	CLUTCH BOOSTER	137
001 295 67 07	24 051 310	CLUTCH BOOSTER	138
001 295 95 06	21 290 506	CLUTCH MASTER CYLINDER	186
001 330 01 35	23 330 035	TIE ROD END	275
001 330 21 35	23 330 135	TIE ROD END	276
001 330 50 35	63 450 071	PROPELLER SHAFT REP. SET	33
001 429 68 44	24 001 200	RELAY VALVE	146
001 430 32 81	63 451 094	HAND BRAKE VALVE	144

Umschlüsselung OEM / Cross Reference OEM

DB	AL-HU TECH	Description	Page
001 431 00 06	24 303 473	PRESSURE REGULATOR	145
001 431 47 06	22 400 001	4-CIRCUIT PROTECTION VALVE	153
001 431 59 06	61 451 655	4-CIRCUIT PROTECTION VALVE	153
001 431 63 06	22 015 004	PRESSURE LIMITER VALVE	145
001 431 78 15	24 500 006	AIR DRYER	121
001 431 81 15	24 500 006	AIR DRYER	121
001 431 83 05	24 315 080	FOOT BRAKE VALVE	143
001 431 89 05	24 315 080	FOOT BRAKE VALVE	143
001 460 05 48	23 460 048	TIE ROD END	276
001 460 11 05	63 450 559	DRAG LINK	271
001 460 13 05	63 450 557	DRAG LINK	271
001 460 14 48	23 460 448	TIE ROD END	277
001 460 15 05	63 450 556	DRAG LINK	270
001 460 17 48	23 460 148	TIE ROD END	276
001 460 22 48	23 460 248	TIE ROD END	276
001 460 29 05	63 450 840	DRAG LINK	272
001 460 70 80	21 460 080	STEERING PUMP	274
001 460 71 05	63 450 558	DRAG LINK	271
001 460 79 48	23 460 048	TIE ROD END	276
001 460 96 48	23 460 148	TIE ROD END	276
001 462 11 30	24 462 130	STEERING LOCK	257
001 501 22 82	21 501 083	TURBO HOSE	364
001 540 46 45	15 226 445	STEERING COLUMN SWITCH	389
001 540 62 70	28 540 004	TAIL LAMP	258
001 540 63 70	28 540 003	TAIL LAMP	257
001 542 23 17	21 542 317	TEMPERATURE SENSOR	393
001 542 40 16	25 542 016	RPM METER	167
001 542 48 19	29 542 819	STARTER INTERLOCK	171
001 542 84 18	63 450 790	ABS SENSOR	104
001 542 85 18	63 450 792	ABS SENSOR	104
001 542 87 16	25 542 716	RPM METER	167
001 542 88 18	63 450 789	ABS SENSOR	104
001 542 89 18	63 450 792	ABS SENSOR	104
001 542 99 02	25 542 902	OIL PRESSURE GAUGE	380
001 544 92 90	28 252 784	REVERSE LIGHT LENS	254
001 545 01 09	21 545 109	BRAKE LIGHT SWITCH	377
001 545 38 09	25 545 609	BRAKE-LIGHT SWITCH	378
001 545 47 09	29 545 004	SWITCH	392
001 545 47 14	25 545 814	REVERSE LIGHT SWITCH	385
001 545 49 14	25 545 914	STARTER SWITCH	388
001 545 68 14	25 546 814	REVERSE LIGHT SWITCH	386
001 545 73 09	29 545 003	SWITCH	392
001 545 76 14	25 545 714	REVERSE LIGHT SWITCH	385
001 545 84 09	29 545 002	SWITCH	391
001 546 54 41	29 546 001	CABLE CONNECTOR	378
001 553 00 01	28 553 301	CABIN PUMP	218
001 553 25 05	28 553 905	CABIN CYLINDER	211
001 553 34 01	28 553 114	CABIN PUMP	217
001 553 35 05	28 553 805	CABIN CYLINDER	210
001 553 36 01	28 553 113	CABIN PUMP	217
001 553 36 05	28 554 005	CABIN CYLINDER	211
001 553 37 01	28 553 112	CABIN PUMP	217
001 553 38 01	28 553 115	CABIN PUMP	217
001 553 40 01	28 553 401	CABIN PUMP	218

Umschlüsselung OEM / Cross Reference OEM

DB	AL-HU TECH	Description	Page
001 553 41 01	28 553 116	CABIN PUMP	218
001 553 42 05	28 553 505	CABIN CYLINDER	210
001 553 43 05	28 553 605	CABIN CYLINDER	210
001 553 59 01	28 553 801	CABIN PUMP	218
001 553 87 05	28 554 705	CABIN CYLINDER	212
001 811 21 33	28 811 133	MIRROR GLASS	251
001 820 39 21	63 450 207	FLASHER LAMP	233
001 820 40 21	63 450 208	FLASHER LAMP	233
001 824 30 01	28 820 042	WIPER MOTOR	267
001 830 02 08	28 830 208	BLOWER MOTOR	206
001 830 03 08	28 830 108	BLOWER MOTOR	206
001 830 04 08	28 830 508	BLOWER MOTOR	207
001 830 21 84	28 830 184	SOLENOID VALVE	357
001 830 27 08	63 450 206	BLOWER MOTOR	207
001 830 87 08	28 830 708	BLOWER MOTOR	207
001 835 07 47	28 835 747	CABIN FILTER	213
001 835 83 01	18 835 301	HEAT EXCHANGER	246
001 980 84 64	28 980 464	GAS SPRING	234
001 981 39 31	63 450 839	JOINT BEARING	248
001 987 52 40	63 451 180	RUBBER MOUNTING	39
001 987 53 40	23 326 096	RUBBER MOUNTING	38
001 987 71 40	63 451 181	RUBBER MOUNTING	40
001 997 61 36	22 036 000	3/2 DIRECTIONAL CONTROL VALVE	201
002 094 52 82	21 094 282	TURBO HOSE	363
002 094 54 82	21 094 085	TURBO HOSE	362
002 094 55 82	21 094 682	TURBO HOSE	363
002 094 63 82	21 094 382	TURBO HOSE	363
002 094 66 82	21 094 682	TURBO HOSE	363
002 094 69 82	21 094 983	TURBO HOSE	363
002 151 81 01	21 416 047	STARTER MOTOR	174
002 154 05 06	21 192 004	VOLTAGE REGULATOR	177
002 154 17 05	21 311 301	VOLTAGE REGULATOR	178
002 154 39 06	21 192 006	VOLTAGE REGULATOR	178
002 154 84 06	21 311 301	VOLTAGE REGULATOR	178
002 154 96 06	21 192 014	VOLTAGE REGULATOR	178
002 188 43 01	21 188 301	OIL COOLER	331
002 205 65 06	63 451 404	FAN CLUTCH	313
002 205 70 06	21 205 506	FAN BLADE	308
002 205 93 06	21 205 606	FAN BLADE	308
002 205 97 06	21 200 003	FAN CLUTCH	310
002 250 18 15	11 250 115	CLUTCH RELEASE BEARING	189
002 250 49 15	21 250 002	CLUTCH RELEASE BEARING	189
002 250 51 15	21 250 105	CLUTCH RELEASE BEARING	189
002 250 72 15	21 250 615	CLUTCH RELEASE BEARING	190
002 250 73 15	21 250 315	CLUTCH RELEASE BEARING	190
002 250 74 15	21 250 415	CLUTCH RELEASE BEARING	190
002 250 76 15	21 250 615	CLUTCH RELEASE BEARING	190
002 250 78 15	21 250 815	CLUTCH RELEASE BEARING	190
002 250 81 15	21 250 815	CLUTCH RELEASE BEARING	190
002 250 98 15	21 250 815	CLUTCH RELEASE BEARING	190
002 260 06 63	63 451 655	GEAR CHANGE SERVO	193
002 295 04 06	21 290 002	CLUTCH MASTER CYLINDER	186
002 295 07 06	21 290 001	CLUTCH MASTER CYLINDER	186
002 323 15 00	21 323 001	SHOCK ABSORBER	57

Umschlüsselung OEM / Cross Reference OEM

DB	AL-HU TECH	Description	Page
002 323 16 00	21 323 002	SHOCK ABSORBER	57
002 429 92 44	24 001 200	RELAY VALVE	146
002 431 01 05	24 002 210	TRAILER CONTROL VALVE	152
002 431 04 06	22 400 001	4-CIRCUIT PROTECTION VALVE	153
002 431 06 05	24 319 080	FOOT BRAKE VALVE	143
002 431 13 06	22 400 007	4-CIRCUIT PROTECTION VALVE	153
002 431 28 05	63 450 930	TRAILER CONTROL VALVE	152
002 431 43 06	24 303 473	PRESSURE REGULATOR	145
002 431 48 05	24 002 200	TRAILER CONTROL VALVE	152
002 431 81 05	24 315 080	FOOT BRAKE VALVE	143
002 460 43 05	24 460 650	DRAG LINK	270
002 460 44 05	24 460 650	DRAG LINK	270
002 460 61 05	23 460 205	DRAG LINK	269
002 460 62 05	23 460 205	DRAG LINK	269
002 540 23 47	25 540 347	COMBINATION INSTRUMENT	223
002 540 44 17	21 540 417	SENSOR	387
002 540 62 44	25 226 921	STEERING COLUMN SWITCH	391
002 542 17 17	25 542 171	OIL PRESSURE SWITCH	381
002 542 22 18	63 450 788	ABS SENSOR	103
002 542 31 18	23 752 808	ABS SENSOR	102
002 542 38 18	13 927 003	ABS SENSOR	101
002 542 67 18	63 450 796	ECAS HEIGHT SENSOR	142
002 542 67 20	25 542 120	HORN 24V, 335 HZ	164
002 542 73 17	21 542 917	TEMPERATURE SENSOR	393
002 544 12 90	63 450 222	TAIL LAMP LENS	258
002 544 16 90	63 450 223	TAIL LAMP LENS	258
002 544 36 90	63 450 222	TAIL LAMP LENS	258
002 544 79 32	25 215 002	INDICATOR RELAY	164
002 544 80 32	25 215 550	INDICATOR RELAY	165
002 545 21 14	AK27501	PUSH KEY	383
002 545 24 07	25 545 407	ROCKER SWITCH	386
002 553 10 05	28 553 405	CABIN CYLINDER	209
002 553 68 05	28 553 907	CABIN CYLINDER	211
002 553 88 05	28 554 105	CABIN CYLINDER	212
002 553 91 05	28 553 906	CABIN CYLINDER	211
002 553 92 05	28 553 705	CABIN CYLINDER	210
002 810 08 14	26 810 814	MIRROR BRACKET	250
002 810 09 14	26 810 914	MIRROR BRACKET	250
002 830 27 84	28 830 784	SOLENOID VALVE	357
002 830 84 08	28 830 002	BLOWER MOTOR	205
002 835 24 01	18 835 401	HEAT EXCHANGER	246
002 981 17 05	21 401 035	TAPER ROLLER BEARING	88
002 997 54 52	63 451 182	TURBO HOSE	365
002 997 92 82	21 203 026	COMPRESSOR HOSE	288
002 997 97 90	63 451 410	CLAMP	287
003 091 27 01	21 440 071	FUEL FEED PUMP	323
003 151 56 01	21 418 012	STARTER MOTOR	174
003 151 57 01	21 416 047	STARTER MOTOR	174
003 151 60 01	21 416 024	STARTER MOTOR	173
003 151 66 01	21 417 036	STARTER MOTOR	174
003 151 67 01	21 416 040	STARTER MOTOR	173
003 151 95 01	21 416 022	STARTER MOTOR	173
003 153 89 28	21 153 928	KNOCK SENSOR	144
003 153 90 28	21 542 917	TEMPERATURE SENSOR	393

Umschlüsselung OEM / Cross Reference OEM

DB	AL-HU TECH	Description	Page
003 205 00 06	21 205 006	FAN BLADE	306
003 205 01 06	21 205 106	FAN BLADE	307
003 205 06 06	21 205 007	FAN BLADE	306
003 205 29 06	28 200 906	FAN BLADE	309
003 205 36 06	21 205 009	FAN BLADE	307
003 205 42 06	21 205 206	FAN BLADE	308
003 250 14 15	21 250 002	CLUTCH RELEASE BEARING	189
003 326 44 00	63 450 173	SHOCK ABSORBER	61
003 430 33 81	22 722 004	HAND BRAKE VALVE REPAIR KIT	144
003 430 73 81	63 450 569	HAND BRAKE VALVE	143
003 430 74 81	63 450 569	HAND BRAKE VALVE	143
003 431 36 06	24 303 474	PRESSURE REGULATOR	146
003 460 50 80	21 460 880	STEERING PUMP	275
003 542 26 18	23 752 121	ECAS HEIGHT SENSOR	141
003 542 33 05	25 542 305	TEMPERATURE GAUGE	392
003 542 35 18	63 450 791	ABS SENSOR	104
003 542 45 18	63 450 794	ABS SENSOR	105
003 542 46 18	63 450 793	ABS SENSOR	105
003 544 06 32	25 215 250	INDICATOR RELAY	165
003 544 50 32	25 215 150	INDICATOR RELAY	164
003 545 16 14	25 545 614	REVERSE LIGHT SWITCH	385
003 545 83 24	25 226 039	STEERING COLUMN SWITCH	389
003 545 92 14	25 545 009	EXHAUST BRAKE SWITCH	379
003 820 50 42	28 820 042	WIPER MOTOR	267
003 830 05 08	28 830 001	BLOWER MOTOR	205
003 981 32 05	63 451 183	BALL BEARING	2
004 151 02 01	21 219 007	ALTERNATOR	156
004 151 32 01	21 219 007	ALTERNATOR	156
004 151 58 01	21 367 034	STARTER MOTOR	172
004 151 59 01	21 368 024	STARTER MOTOR	172
004 151 60 01	21 431 002	STARTER MOTOR	175
004 151 61 01	21 417 001	STARTER MOTOR	174
004 151 86 01	21 231 003	STARTER MOTOR	171
004 151 94 01	21 372 001	STARTER MOTOR	172
004 153 25 28	21 153 528	TEMPERATURE SENSOR	393
004 153 31 28	63 453 022	AIR PRESSURE SENSOR	377
004 153 43 28	21 153 328	SENSOR	357
004 203 84 75	21 204 071	THERMOSTAT 71 DEGREES	358
004 429 38 44	63 450 152	RELAY VALVE	147
004 429 60 44	63 450 580	SOLENOID VALVE	151
004 429 61 44	24 000 001	ABS SOLENOID VALVE	105
004 429 63 44	22 116 075	RELAY VALVE	146
004 542 43 17	25 542 431	OIL PRESSURE SWITCH	381
004 542 45 18	63 450 791	ABS SENSOR	104
004 542 46 18	63 450 793	ABS SENSOR	105
004 542 47 18	63 450 794	ABS SENSOR	105
004 542 56 17	21 542 917	TEMPERATURE SENSOR	393
004 542 89 17	25 542 891	OIL PRESSURE SWITCH	382
004 545 54 14	29 545 010	PRESSURE SWITCH	382
004 545 99 14	63 450 095	PUSH BUTTON SWITCH	383
004 820 67 42	28 820 242	WIPER MOTOR	267
004 826 25 90	28 820 590	HEAD LAMP GLASS	244
004 826 26 90	28 820 690	HEAD LAMP GLASS	244
004 981 43 05	21 401 019	BALL BEARING	2

Umschlüsselung OEM / Cross Reference OEM

DB	AL-HU TECH	Description	Page
005 151 20 01	21 231 002	STARTER MOTOR	171
005 151 28 01	21 417 001	STARTER MOTOR	174
005 151 50 01	21 372 006	STARTER MOTOR	173
005 151 64 01	21 372 006	STARTER MOTOR	173
005 151 70 01	21 372 006	STARTER MOTOR	173
005 203 26 75	21 204 083	THERMOSTAT 83 DEGREES	359
005 203 27 75	21 204 079	THERMOSTAT 79 DEGREES	359
005 203 28 75	21 204 071	THERMOSTAT 71 DEGREES	358
005 323 60 00	63 450 027	SHOCK ABSORBER	59
005 323 95 00	21 323 004	SHOCK ABSORBER	57
005 326 11 00	63 450 029	SHOCK ABSORBER	59
005 326 33 00	63 450 041	SHOCK ABSORBER	60
005 429 18 44	63 450 548	CHARGING VALVE	136
005 542 94 17	25 542 417	OIL PRESSURE SWITCH	381
005 545 51 24	25 226 758	STEERING COLUMN SWITCH	391
005 545 74 24	25 226 424	STEERING COLUMN SWITCH	390
005 545 92 24	25 545 224	HAZARD WARNING SWITCH	379
005 820 21 42	63 450 171	WIPER MOTOR	267
005 820 90 42	28 820 043	WINDOW LIFTER MOTOR	265
005 820 91 42	28 820 044	WINDOW LIFTER MOTOR	265
005 988 82 78	58 290 001	CLIP	223
005 990 50 40	63 450 271	SHIM	56
005 997 06 90	63 451 411	CLAMP	287
006 151 15 01	21 372 006	STARTER MOTOR	173
006 151 69 01	21 372 006	STARTER MOTOR	173
006 153 14 28	63 453 022	AIR PRESSURE SENSOR	377
006 323 07 00	21 323 007	SHOCK ABSORBER	58
006 323 09 00	21 323 006	SHOCK ABSORBER	58
006 326 01 00	63 450 032	SHOCK ABSORBER	60
006 545 11 14	29 545 009	PRESSURE SWITCH	382
006 981 89 10	21 910 005	NEEDLE BEARING	166
007 151 04 01	21 372 006	STARTER MOTOR	173
007 154 54 02	21 489 325	ALTERNATOR	158
007 154 68 02	21 469 744	ALTERNATOR	157
007 154 81 02	21 469 796	ALTERNATOR	157
007 154 90 02	21 489 728	ALTERNATOR	158
007 154 92 02	21 468 053	ALTERNATOR	157
007 545 82 24	25 226 124	STEERING COLUMN SWITCH	389
007 993 56 01	63 450 267	REPAIR KIT SPRING	147
008 154 78 02	21 689 535	ALTERNATOR	159
008 542 22 06	25 542 206	SPEEDOMETER	170
008 542 80 17	21 542 017	SENDER UNIT	386
008 542 81 17	21 542 117	SENDER UNIT	356
008 545 01 24	25 226 124	STEERING COLUMN SWITCH	389
008 545 01 24 7C45	25 226 124	STEERING COLUMN SWITCH	389
009 154 02 02	21 335 002	ALTERNATOR	156
009 154 07 02	21 469 982	ALTERNATOR	158
009 154 98 02	21 469 115	ALTERNATOR	157
009 542 10 17	25 542 001	PULSE GENERATOR	383
010 094 12 02	21 094 202	AIR CLEANER, oil bath	279
010 154 91 02	21 033 019	ALTERNATOR	156
010 154 92 02	21 033 023	ALTERNATOR	156
011 154 86 02	21 555 001	ALTERNATOR	158
011 154 96 02	21 689 541	ALTERNATOR	160

Umschlüsselung OEM / Cross Reference OEM

DB	AL-HU TECH	Description	Page
011 542 63 17	63 451 414	SENDER UNIT	356
011 981 13 05	21 981 003	TAPER ROLLER BEARING	88
012 154 10 02	21 555 002	ALTERNATOR	159
012 542 05 17	21 542 517	OIL PRESSURE SWITCH	381
012 542 47 17	63 450 754	ABS SENSOR	102
012 542 49 17	63 450 203	SENDER UNIT	356
013 154 28 02	21 555 001	ALTERNATOR	158
013 154 29 02	21 555 004	ALTERNATOR	159
013 154 78 02	21 555 032	ALTERNATOR	159
013 542 67 17	22 542 717	ABS SENSOR	101
013 542 71 17	63 451 415	SENDER UNIT	356
015 542 24 17	21 542 617	SPEED SENSOR	387
015 542 27 17	29 545 008	SPEED SENSOR	388
016 094 57 02	21 094 702	AIR CLEANER	279
019 997 55 82	63 450 991	STEERING HOSE	273
022 545 25 32	25 545 624	RELAY	384
024 997 03 82	21 501 084	TURBO HOSE	364
024 997 07 82	21 501 085	TURBO HOSE	364
071 555 11 05 01	24 997 073	EXHAUST CLAMP	296
071 555 11 45 00	24 997 085	EXHAUST CLAMP	297
111 018 03 02	12 018 302	OIL CAP	330
164 540 10 17	13 540 517	BRAKE WEAR INDICATOR	134
211 720 03 46	18 720 001	WINDOW LIFTER	259
211 720 04 46	18 720 002	WINDOW LIFTER	260
211 730 03 46	18 720 003	WINDOW LIFTER	260
211 730 04 46	18 720 004	WINDOW LIFTER	260
220 540 15 17	13 540 517	BRAKE WEAR INDICATOR	134
300 240 01 17	23 240 117	RUBBER MOUNTING	36
301 205 00 02	63 450 264	SHAFT	357
301 206 00 72	63 450 261	NUT	330
301 206 01 10	63 450 265	V-BELT PULLEY	367
301 206 01 13	63 450 260	HUB	326
301 206 02 10	63 450 274	V-BELT PULLEY	367
304 410 00 31	21 410 002	UNIVERSAL JOINT	92
305 205 07 10	63 450 263	V-BELT PULLEY	367
305 421 18 36	22 010 008	BRAKE CAMSHAFT	126
305 421 19 36	22 010 009	BRAKE CAMSHAFT	127
307 206 02 10	63 450 262	V-BELT PULLEY	367
307 240 00 17	28 240 001	ENGINE MOUNTING	296
307 420 03 39	24 420 049	BRAKE SHOE SLEEVE REPAIR KIT	130
307 420 40 02	22 001 001	BRAKE PIN KIT	128
307 420 41 02	63 451 675	REP. KIT BRAKE SHOE PIN	148
307 421 00 74	63 451 115	PIN	30
31 100 54 113	28 000 003	FILTER HOUSING	314
310 268 00 35	22 268 035	BUSHING	182
314 268 02 43	22 268 243	BUSHING	182
314 268 02 50	22 268 250	BUSHING	183
314 810 13 16	28 810 316	REARVIEW MIRROR	252
322 285 00 82	23 326 087	PROPELLER SHAFT MOUNTING	33
322 720 02 16	28 720 216	DOOR STOP	232
322 725 01 02	28 725 102	WINDOW LIFTER	264
322 725 02 02	28 725 202	WINDOW LIFTER	265
322 725 03 02	28 725 302	WINDOW LIFTER	265
322 760 00 61	28 760 061	DOOR HANDLE	225

Umschlüsselung OEM / Cross Reference OEM

DB	AL-HU TECH	Description	Page
322 760 01 61	28 760 161	DOOR HANDLE	225
322 766 07 01	28 766 701	DOOR HANDLE	229
322 880 06 60	28 880 660	HOOD CATCH, LOWER	247
327 030 02 11	28 030 006	FLYWHEEL	319
335 420 00 39	24 420 039	BRAKE SHOE PIN KIT	130
335 573 00 36	63 450 822	CLUTCH HOSE	184
337 410 00 31	21 410 007	UNIVERSAL JOINT	92
343 151 70 15	21 005 498	STARTER ARMATURE	170
343 330 02 19	63 451 489	KING PIN SET	28
343 460 15 05	24 460 505	DRAG LINK	270
343 586 00 32	23 326 088	BALL JOINT REPAIR KIT	3
345 030 02 05	28 030 002	FLYWHEEL	318
346 017 01 60	21 997 065	INJECTOR WASHER	329
346 070 03 35	63 450 993	INJECTION LINE	328
346 070 10 33	21 203 029	INJECTION LINE	328
346 320 01 28	63 450 582	STABILIZER KIT	74
346 320 50 63	21 320 063	SPRING SHACKLE	67
346 330 00 19	23 326 089	KING PIN SET	27
346 336 00 62	21 336 062	THRUST WASHER	90
346 350 04 43	21 350 443	GROOVED NUT	24
346 350 04 45	21 350 445	FLANGE	23
346 353 00 85	63 451 670	GEAR	24
346 353 01 24	63 451 676	RETAINING WASHER	35
346 353 01 26	21 353 126	NUT	29
346 353 02 24	63 451 677	WASHER	94
346 353 06 55	63 450 105	SHIFT CYLINDER	56
346 353 08 25	63 451 678	THREADED RING	89
346 353 09 25	21 353 925	THREADED RING	88
346 356 14 15	23 356 415	PRESSURE RING	31
346 356 25 01	21 356 005	WHEEL HUB	96
346 356 29 01	21 356 028	WHEEL HUB	97
346 356 31 01	21 356 006	WHEEL HUB	96
346 421 31 06	63 451 679	BRAKE ANCHOR PLATE	125
346 423 00 58	23 332 011	SEAL HOLDER	55
346 423 07 52	24 420 243	SPACER	61
346 423 09 06	06 501 568	BRAKE ANCHOR PLATE	125
346 460 01 05	24 460 649	DRAG LINK	269
346 466 01 81	63 450 992	STEERING HOSE	274
346 993 08 10	22 000 044	BRAKE SHOE SPRING	131
346 994 01 09	21 994 109	LOCK PLATE	29
347 504 00 12	63 451 184	RUBBER MOUNTING	40
352 010 01 62	21 018 535	OIL SEPERATOR	340
352 030 39 05	21 030 353	FLYWHEEL	316
352 030 73 05	21 030 352	FLYWHEEL	315
352 054 05 01	21 054 501	VALVE TAPPET	365
352 130 01 08	21 130 408	AIR COMPRESSOR PISTON ASSY	118
352 130 03 19	21 130 319	AIR COMPRESSOR CYLINDER HEAD	112
352 155 06 50	63 451 185	BUSHING	286
352 268 00 50	22 268 050	BUSHING	182
352 268 03 35	22 268 335	BUSHING	183
352 268 04 50	22 268 450	BUSHING	183
352 402 00 71	63 451 186	WHEEL BOLT	94
353 200 36 01	21 200 017	WATER PUMP	368
353 200 56 01	21 200 044	WATER PUMP	370

Umschlüsselung OEM / Cross Reference OEM

DB	AL-HU TECH	Description	Page
355 030 13 05	28 030 005	FLYWHEEL	319
355 180 01 01	21 180 101	OIL PUMP	338
355 180 11 65	21 180 165	OIL COOLER	330
355 180 12 65	21 180 265	OIL COOLER	331
355 330 03 19	63 451 488	KING PIN SET	28
355 353 01 58	63 451 152	SEAL HOLDER	56
355 353 01 76	616705	THRUST WASHER	89
355 353 02 34	63 450 104	SELECTOR FORK	56
355 353 09 35	616702	DRIVE SHAFT	22
355 353 09 50	616706	KING PIN BUSHING	26
355 353 10 50	616707	KING PIN BUSHING	26
355 353 18 62	616701	THRUST WASHER	89
355 353 22 45	63 450 103	DRIVING FLANGE	22
355 356 01 26	21 620 048	LOCK RING	29
355 356 12 15	23 356 215	PRESSURE RING	31
356 268 00 89	22 258 089	BALL SOCKET, GEARSHIFT LINKAGE	181
356 326 07 00	21 323 008	SHOCK ABSORBER	58
356 333 13 04	23 333 304	CONTROL ARM	268
356 540 00 17	13 540 356	BRAKE WEAR INDICATOR	134
356 540 06 17	63 450 786	ABS SENSOR	103
357 240 04 18	63 451 187	RUBBER MOUNTING	40
357 320 15 34	63 450 187	AIR SPRING BASE	2
357 320 15 43	63 450 269	BRACKET	15
357 320 17 43	63 450 270	BRACKET	15
357 323 04 00	63 450 065	SHOCK ABSORBER	60
357 420 05 38	63 450 549	SLACK ADJUSTER	150
357 420 06 38	63 450 550	SLACK ADJUSTER	151
357 420 07 38	63 450 551	SLACK ADJUSTER	151
357 540 00 45	25 226 045	STEERING COLUMN SWITCH	389
357 750 00 50	63 450 215	SNAP LOCK	256
360 030 08 11	28 030 006	FLYWHEEL	319
360 320 00 41	63 450 478	STABILIZER KIT	73
360 320 03 41	63 451 188	STABILIZER KIT	75
360 323 00 85	63 451 189	STABILIZER MOUNTING	85
360 323 01 51	63 451 190	SPACER RING	61
360 330 06 19	63 450 051	KING PIN SET	27
360 330 07 19	63 451 191	KING PIN SET	27
360 420 03 41	22 010 002	REP.KIT BRAKE CAMSHAFT	148
360 420 04 41	22 010 003	REP.KIT BRAKE CAMSHAFT	148
363 250 01 14	21 250 114	CLUTCH RELEASE SHAFT REP. KIT	192
363 320 02 28	63 451 192	STABILIZER KIT	75
363 506 02 35	63 451 193	RADIATOR HOSE	346
363 891 06 17	63 451 194	STABILIZER MOUNTING	85
363 891 07 17	63 451 195	STABILIZER MOUNTING	85
364 030 01 05	28 030 003	FLYWHEEL	319
366 030 09 05	28 030 004	FLYWHEEL	319
366 098 01 83	21 098 183	DISCHARGE HOSE	295
366 200 04 22	21 200 004	FAN CLUTCH	310
366 200 59 01	21 200 901	WATER PUMP	373
371 501 80 82	21 094 082	RADIATOR HOSE	344
376 200 00 01	21 200 046	WATER PUMP	370
380 540 21 81	63 450 774	CONNECTING CABLE	140
380 540 22 81	63 450 775	CONNECTING CABLE	140
380 553 00 82	63 450 738	CABIN HOSE	214

Umschlüsselung OEM / Cross Reference OEM

DB	AL-HU TECH	Description	Page
381 290 16 14	25 000 000	CLUTCH PIPE	187
381 290 18 14	25 000 001	CLUTCH PIPE	187
381 290 19 14	25 000 002	CLUTCH PIPE	187
381 290 20 14	25 000 003	CLUTCH PIPE	188
381 337 05 11	63 450 006	UNIVERSAL JOINT	92
381 410 02 31	21 410 001	UNIVERSAL JOINT	91
381 410 15 22	24 410 522	PROPELLER SHAFT BEARING	32
381 528 01 91	21 528 191	RUBBER BELLOW, AIR INTAKE	354
381 586 00 31	63 451 196	REPAIR KIT, CABIN MOUNTING	253
381 723 02 01	28 723 201	DOOR LOCK	231
381 723 03 01	28 723 301	DOOR LOCK	232
381 725 00 02	28 725 000	WINDOW LIFTER	264
381 725 00 60	28 725 043	WINDOW HANDLE	259
381 725 01 02	28 725 001	WINDOW LIFTER	264
381 725 02 79	28 725 279	DOOR HANDLE	224
381 725 03 79	28 725 379	DOOR HANDLE	225
381 760 00 59	28 760 059	DOOR HANDLE	225
381 766 00 43	28 766 043	DOOR HANDLE	228
381 810 38 16	28 811 816	REARVIEW MIRROR	252
381 810 71 16	28 810 116	REARVIEW MIRROR	252
381 824 02 28	26 824 001	WIPER ARM	267
385 250 00 14	21 250 014	CLUTCH RELEASE SHAFT REP. KIT	192
385 260 05 63	25 260 001	SHIFTING VALVE	200
385 260 94 33	25 260 002	SHIFTING ROD	199
385 268 14 74	63 450 843	GEARSHIFT PIN	195
385 320 00 65	63 451 197	SPRING PIN KIT	64
385 350 00 06	23 350 124	CONTROL ARM	20
385 351 05 72	63 451 673	12-POINT COLLAR NUT	100
385 351 06 72	63 451 680	12-POINT COLLAR NUT	100
385 353 08 35	63 450 102	OUTPUT SHAFT	30
385 410 01 31	21 410 007	UNIVERSAL JOINT	92
385 410 02 31	63 450 007	UNIVERSAL JOINT	92
386 332 00 62	21 215 001	THRUST WASHER	89
387 310 00 77	28 310 077	REPAIR KIT, CABIN MOUNTING	253
387 320 00 28	63 450 566	STABILIZER KIT	74
387 320 01 28	63 450 480	STABILIZER KIT	74
387 320 03 28	63 451 198	STABILIZER KIT	75
387 320 05 28	63 451 199	STABILIZER KIT	75
387 323 01 85	63 451 200	STABILIZER MOUNTING	85
387 323 02 85	21 000 006	STABILIZER BUSHING	68
387 323 03 85	63 451 201	STABILIZER MOUNTING	86
387 325 00 01	63 451 681	SPRING BRACKET	62
387 326 00 00	21 323 003	SHOCK ABSORBER	57
387 326 01 81	63 450 132	STABILIZER MOUNTING	82
387 326 02 81	23 326 090	STABILIZER BUSHING	70
387 421 00 74	63 450 824	SPRING RETAINING PIN	152
387 460 14 05	63 450 834	DRAG LINK	272
387 460 33 05	63 450 834	DRAG LINK	272
387 490 00 41	28 490 001	EXHAUST CLAMP	297
387 490 06 25	28 490 002	EXHAUST CONNECTOR	300
387 501 15 82	63 451 202	RADIATOR HOSE	346
387 501 16 82	63 451 203	RADIATOR HOSE	347
387 501 17 82	63 451 204	RADIATOR HOSE	347
387 553 01 82	63 450 739	CABIN HOSE	214

Umschlüsselung OEM / Cross Reference OEM

DB	AL-HU TECH	Description	Page
387 553 03 82	21 203 011	CABIN HOSE	214
387 891 05 51	28 891 051	CABIN SPRING	221
387 891 10 51	28 891 151	CABIN SPRING	221
389 320 00 65	63 450 471	SPRING PIN KIT	64
389 320 01 65	63 451 205	SPRING PIN KIT	65
389 320 06 84	21 320 684	HUB CAP	25
389 325 21 52	21 325 152	SPACER WASHER	61
389 326 00 81	63 451 206	STABILIZER MOUNTING	86
389 334 00 25	21 334 025	HUB CAP	25
389 334 15 01	21 356 003	WHEEL HUB	96
389 410 33 02	63 450 063	PROPELLER SHAFT	31
389 990 50 60	21 990 060	NUT	29
393 320 02 28	21 320 001	STABILIZER KIT	72
393 320 10 18	63 450 188	AIR SPRING BASE	2
393 326 04 81	63 451 207	STABILIZER MOUNTING	86
393 330 03 03	63 451 671	TIE ROD	91
393 420 25 19	24 420 019	BRAKE SHOE	129
395 312 01 24	63 451 683	SPRING MOUNTING	64
395 320 01 65	63 451 208	SPRING PIN KIT	65
395 320 02 65	63 450 844	SPRING PIN KIT	64
395 323 01 40	21 323 140	BRACKET	15
395 350 12 06	23 350 206	CONTROL ARM	268
395 410 06 22	24 410 022	PROPELLER SHAFT BEARING	32
395 990 05 01	21 990 501	CARDAN BOLT	17
396 323 00 50	23 323 081	STABILIZER MOUNTING	79
402 030 30 01	21 030 022	CRANKSHAFT	293
402 130 02 20	21 130 220	AIR COMPRESSOR REPAIR KIT	120
402 130 03 20	21 130 320	AIR COMPRESSOR VALVE PLATE KIT	121
402 130 06 08	21 130 608	AIR COMPRESSOR PISTON ASSEMBLY	117
403 010 33 72	21 011 372	OIL DIPSTICK	333
403 017 02 71	21 017 003	PRESSURE SCREW	343
403 030 13 05	21 030 402	FLYWHEEL	316
403 030 14 05	21 030 403	FLYWHEEL	316
403 032 03 05	28 032 001	FLYWHEEL RING GEAR	320
403 032 03 09	21 032 309	CRANKSHAFT RACE	294
403 050 03 03	21 050 303	CRANKSHAFT GEAR	293
403 050 12 36	21 050 236	ROCKER ARM BRACKET	353
403 054 18 01	21 054 101	VALVE TAPPET	365
403 077 07 12	63 450 096	DRIVE GEAR	295
403 130 16 45	21 130 045	AIR COMPRESSOR FLANGE	113
403 130 28 16	21 130 816	AIR COMPRESSOR CONROD	108
403 131 07 16	21 131 016	AIR COMPRESSOR CRANKSHAFT	109
403 131 10 16	21 131 116	AIR COMPRESSOR CRANKSHAFT	110
403 180 14 38	21 180 438	OIL FILTER HEAD	334
403 180 17 01	21 180 701	OIL PUMP	339
403 180 28 01	21 180 801	OIL PUMP	339
403 180 39 38	21 180 938	OIL FILTER HEAD	335
403 200 09 26	21 200 926	FAN SPACER	314
403 200 70 01	21 200 036	WATER PUMP	369
403 200 71 01	21 200 102	WATER PUMP	371
403 200 73 01	21 200 202	WATER PUMP	372
403 200 75 01	21 200 501	WATER PUMP	373
403 200 77 01	21 200 038	WATER PUMP	369
403 202 06 10	21 200 079	V-BELT PULLEY	366

Umschlüsselung OEM / Cross Reference OEM

DB	AL-HU TECH	Description	Page
403 202 07 10	21 200 080	V-BELT PULLEY	366
403 202 09 10	28 202 910	V-BELT PULLEY	366
403 990 00 10	21 130 051	AIR COMPRESSOR CRANKSHAFT SCRE	110
407 015 07 02	21 010 233	TIMING CASE	361
407 030 06 20	21 030 620	CONROD	291
407 030 07 20	21 030 120	CONROD	290
407 070 01 36	21 203 014	INJECTION LINE SET	327
407 130 05 19	21 130 019	AIR COMPRESSOR CYLINDER HEAD	110
407 130 06 10	24 130 010	AIR COMPRESSOR HOUSING	116
407 131 05 80	21 130 056	AIR COMPRESSOR GASKET	114
407 180 11 38	28 000 001	OIL FILTER HEAD	335
422 010 00 72	21 011 072	OIL DIPSTICK	333
422 010 18 72	21 011 872	OIL DIPSTICK	334
422 030 04 20	21 030 020	CONROD	289
422 030 37 01	21 030 023	CRANKSHAFT	293
422 035 11 14	63 450 847	INTERMEDIATE PIECE	330
422 070 78 33	21 203 028	INJECTION LINE	328
422 140 09 63	21 140 096	THROTTLE VALVE KIT	360
422 180 03 15	21 180 315	OIL RELIEF VALVE	340
422 188 00 01	21 188 501	OIL COOLER	332
422 188 01 01	21 188 401	OIL COOLER	332
422 200 04 04	21 999 001	WATER PUMP KIT	375
422 200 06 04	21 200 035	WATER PUMP KIT	374
422 200 10 01	21 200 902	WATER PUMP	373
422 200 11 01	21 200 601	WATER PUMP	373
422 200 12 01	21 200 501	WATER PUMP	373
422 200 14 01	21 200 050	WATER PUMP	371
423 010 50 33	21 010 033	TIMING CASE	361
423 070 23 33	63 450 994	INJECTION LINE	329
423 180 05 01	21 180 501	OIL PUMP	339
423 180 09 20	21 203 027	OIL LINE	335
423 180 25 01	21 180 501	OIL PUMP	339
435 542 00 17	13 542 017	BRAKE WEAR INDICATOR	136
441 030 04 05	21 030 441	FLYWHEEL	316
441 030 08 20	21 030 720	CONROD	291
441 070 11 33	21 203 006	INJECTION LINE SET	327
441 070 55 33	21 203 007	INJECTION LINE SET	327
441 130 00 08	21 130 108	AIR COMPRESSOR PISTON ASSY	117
441 130 02 20	21 130 120	AIR COMPRESSOR REPAIR KIT	119
441 140 03 63	21 140 036	THROTTLE VALVE KIT	359
441 140 04 63	21 140 046	THROTTLE VALVE KIT	360
441 200 02 01	21 200 040	WATER PUMP	369
441 200 03 01	21 200 040	WATER PUMP	369
442 010 00 72	21 011 072	OIL DIPSTICK	333
442 010 06 13	63 450 574	OIL PAN	338
442 010 32 72	21 010 272	OIL DIPSTICK	333
442 030 02 05	21 030 442	FLYWHEEL	317
442 030 02 20	21 030 220	CONROD	290
442 030 19 05	21 030 445	FLYWHEEL	317
442 031 00 27	21 031 027	CRANKSHAFT RACE	294
442 055 00 20	28 055 001	ADJUSTING SCREW	278
442 070 81 33	21 203 005	INJECTION LINE SET	327
442 070 96 33	21 203 004	INJECTION LINE SET	326
442 130 00 08	21 130 008	AIR COMPRESSOR PISTON ASSEMBLY	117

Umschlüsselung OEM / Cross Reference OEM

DB	AL-HU TECH	Description	Page
442 130 00 20	21 130 061	AIR COMPRESSOR GASKET KIT	115
442 130 01 14	21 130 114	AIR COMPRESSOR CRANKSHAFT	109
442 130 01 45	21 130 445	AIR COMPRESSOR FLANGE	113
442 130 07 20	21 130 720	AIR COMPRESSOR VALVE PLATE KIT	121
442 130 11 20	21 130 018	AIR COMPRESSOR VALVE	120
442 130 32 19	21 130 219	AIR COMPRESSOR CYLINDER HEAD	110
442 131 00 17	24 130 916	AIR COMPRESSOR CONROD	108
442 131 02 17	24 130 916	AIR COMPRESSOR CONROD	108
442 131 05 19	21 130 037	AIR COMPRESSOR CYLINDER HEAD	111
442 140 49 53	63 451 408	EXHAUST BRAKE FLAP	296
442 180 00 15	21 180 015	OIL RELIEF VALVE	339
442 180 05 43	21 180 543	OIL NOZZLE	336
442 200 07 70	21 201 770	BELT TENSIONER PULLEY	285
447 030 03 20	21 030 320	CONROD	291
447 030 04 20	21 030 420	CONROD	291
447 030 18 05	21 030 447	FLYWHEEL	317
447 070 21 33	21 203 015	INJECTION LINE SET	328
447 130 00 08	21 130 041	AIR COMPRESSOR PISTON ASSEMBLY	117
447 130 00 14	21 130 020	AIR COMPRESSOR CRANKSHAFT	109
447 130 00 20	21 130 057	AIR COMPRESSOR VALVE PLATE	120
447 130 05 15	21 130 515	AIR COMPRESSOR	105
447 130 28 15	22 130 001	AIR COMPRESSOR	106
447 130 30 15	22 130 002	AIR COMPRESSOR	106
447 131 02 80	21 130 036	AIR COMPRESSOR GASKET	114
447 132 02 05	21 130 022	AIR COMPRESSOR GEAR	116
447 140 01 63	21 140 186	THROTTLE VALVE KIT	360
457 010 01 30	26 010 130	CYLINDER HEAD COVER	294
457 010 03 72	21 010 972	OIL DIPSTICK	333
457 030 06 05	21 030 457	FLYWHEEL	317
457 030 13 05	21 030 305	FLYWHEEL	315
457 030 26 05	21 030 305	FLYWHEEL	315
457 098 33 07	28 000 017	INTERCOOLER PIPE	329
457 151 03 01	21 372 005	STARTER MOTOR	172
457 200 05 01	21 200 041	WATER PUMP	369
457 200 08 01	21 200 048	WATER PUMP	370
457 200 10 01	21 200 049	WATER PUMP	371
457 200 14 70	21 200 570	BELT TENSIONER	281
457 200 16 70	21 200 572	BELT TENSIONER	282
457 200 17 70	21 200 591	BELT TENSIONER	284
457 200 21 70	21 200 670	BELT TENSIONER	284
457 200 22 70	21 200 570	BELT TENSIONER	281
457 200 31 70	21 200 573	BELT TENSIONER	282
457 200 34 70	21 200 591	BELT TENSIONER	284
457 203 06 30	28 000 018	INTERCOOLER PIPE	329
457 990 20 01	63 451 209	EXHAUST BOLT	296
460 540 06 17	13 540 061	BRAKE WEAR INDICATOR	132
476 050 00 25	21 050 025	VALVE TAPPET	365
497 421 00 74	22 001 002	BRAKE SHOE PIN	130
541 010 07 13	28 010 713	OIL PAN	337
541 010 10 72	21 010 072	OIL DIPSTICK	332
541 010 12 13	28 011 213	OIL PAN	337
541 010 27 33	28 000 020	TIMING CASE	362
541 010 30 33	21 010 133	TIMING CASE	361
541 018 03 33	28 018 333	DIAPHRAGM KIT	295

Umschlüsselung OEM / Cross Reference OEM

DB	AL-HU TECH	Description	Page
541 030 01 05	21 030 521	FLYWHEEL	318
541 030 03 05	28 030 008	FLYWHEEL	320
541 030 05 20	21 030 820	CONROD	292
541 050 08 34	21 050 834	ROCKER ARM, EXHAUST	353
541 050 09 33	21 050 933	ROCKER ARM, INLET	353
541 050 12 36	21 050 336	ROCKER ARM BRACKET	353
541 054 05 05	21 054 505	PUSH ROD	343
541 070 06 46	28 070 646	OVERFLOW VALVE	342
541 130 00 08	21 130 208	AIR COMPRESSOR PISTON ASSY	118
541 130 01 08	21 130 308	AIR COMPRESSOR PISTON ASSY	118
541 130 02 14	21 130 014	AIR COMPRESSOR CRANKSHAFT	109
541 130 06 20	21 130 620	AIR COMPRESSOR VALVE PLATE KIT	121
541 130 08 20	21 130 820	AIR COMPRESSOR VALVE PLATE KIT	279
541 130 27 19	21 130 719	AIR COMPRESSOR CYLINDER HEAD	112
541 130 29 19	21 130 919	AIR COMPRESSOR CYLINDER HEAD	112
541 131 00 17	24 130 916	AIR COMPRESSOR CONROD	108
541 131 01 17	21 130 017	AIR COMPRESSOR CONROD	107
541 131 01 31	21 131 131	AIR COMPRESSOR GASKET	115
541 131 01 42	21 131 142	AIR COMPRESSOR FLANGE	113
541 131 06 19	21 130 119	AIR COMPRESSOR CYLINDER HEAD	111
541 131 06 80	21 130 026	AIR COMPRESSOR GASKET	114
541 131 11 19	21 130 119	AIR COMPRESSOR CYLINDER HEAD	111
541 140 00 63	21 140 016	THROTTLE VALVE KIT	359
541 140 01 63	21 140 016	THROTTLE VALVE KIT	359
541 140 21 03	21 491 050	EXHAUST MANIFOLD	301
541 140 22 03	21 491 051	EXHAUST MANIFOLD	301
541 140 25 03	21 491 052	EXHAUST MANIFOLD	301
541 140 26 03	21 491 053	EXHAUST MANIFOLD	302
541 142 01 80	63 453 005	EXHAUST MANIFOLD GASKET	302
541 180 03 01	21 180 301	OIL PUMP	338
541 180 07 15	21 180 715	PRESSURE RELIEF VALVE	343
541 180 07 43	63 451 418	OIL NOZZLE	336
541 180 08 43	63 450 583	OIL NOZZLE	336
541 184 02 08	21 184 028	COVER, OIL FILTER	293
541 188 02 01	21 188 201	OIL COOLER	331
541 200 00 04	21 999 004	WATER PUMP KIT	375
541 200 06 22	21 201 622	FAN CLUTCH	313
541 200 10 01	21 200 001	WATER PUMP	368
541 200 11 70	21 200 170	BELT TENSIONER	281
541 200 12 01	21 200 201	WATER PUMP	372
541 200 13 22	21 200 029	FAN CLUTCH	311
541 200 15 22	21 200 030	FAN CLUTCH	311
541 200 15 70	21 200 579	BELT TENSIONER	283
541 200 18 22	21 200 030	FAN CLUTCH	311
541 200 18 70	21 200 070	BELT TENSIONER	281
541 200 23 70	21 200 590	BELT TENSIONER	283
541 202 01 10	63 451 405	V-BELT PULLEY	368
541 230 12 11	21 230 611	COMPRESSOR	288
541 230 13 11	21 230 311	COMPRESSOR	288
542 030 05 20	21 030 920	CONROD	292
542 140 00 63	21 140 066	THROTTLE VALVE KIT	360
542 180 00 01	21 180 201	OIL PUMP	338
542 180 01 01	21 180 201	OIL PUMP	338
542 180 02 01	21 180 201	OIL PUMP	338

Umschlüsselung OEM / Cross Reference OEM

DB	AL-HU TECH	Description	Page
542 180 07 01	21 180 201	OIL PUMP	338
542 180 09 22	63 451 416	OIL LINE	336
542 200 01 04	21 200 034	WATER PUMP KIT	374
542 200 19 01	24 200 901	WATER PUMP	374
542 200 20 01	21 200 001	WATER PUMP	368
542 200 21 01	21 200 103	WATER PUMP	372
542 200 22 01	21 200 051	WATER PUMP	371
542 200 23 01	24 200 901	WATER PUMP	374
542 200 24 01	21 200 001	WATER PUMP	368
601 010 04 70	18 010 001	BREATHER PIPE	286
601 540 06 17	13 540 062	BRAKE WEAR INDICATOR	132
601 540 13 17	13 540 131	BRAKE WEAR INDICATOR	134
603 200 05 22	11 201 522	FAN CLUTCH	309
611 200 02 15	21 200 215	THERMOSTAT HOUSING	358
611 200 07 15	21 200 215	THERMOSTAT HOUSING	358
613 333 01 04	23 333 304	CONTROL ARM	268
615 300 01 04	63 451 210	PEDAL	252
615 528 00 82	21 528 082	CONNECTION HOSE	289
617 240 02 17	23 326 092	ENGINE MOUNTING	23
617 320 01 28	63 451 211	STABILIZER KIT	76
617 320 02 28	63 451 212	STABILIZER KIT	76
617 326 00 00	63 450 031	SHOCK ABSORBER	59
617 326 00 50	63 451 213	STABILIZER MOUNTING	86
617 492 00 08	24 492 018	EXHAUST CONNECTING PIECE	299
617 993 06 10	22 000 032	BRAKE SHOE SPRING	130
620 250 02 14	21 254 214	CLUTCH RELEASE SHAFT KIT	191
620 254 01 08	21 254 108	RELEASE LEVER	34
620 254 02 07	25 250 007	CLUTCH RELEASE AXLE	188
620 254 07 08	21 254 708	CLUTCH RELEASE LEVER	191
620 260 00 40	22 260 040	SHIFT KNOB	197
620 268 00 42	22 268 042	SHIFT KNOB	197
620 268 00 97	25 268 097	GEAR LEVER BOOT	194
620 268 01 57	22 268 157	COVER	193
620 268 01 96	63 451 214	GEAR SHIFT BOOT	194
620 295 02 40	63 451 684	BRACKET	16
620 310 01 77	63 451 215	REPAIR KIT, CABIN MOUNTING	253
620 320 00 28	63 450 567	STABILIZER KIT	74
620 320 01 11	63 451 216	STABILIZER KIT	76
620 320 01 28	21 000 007	STABILIZER KIT	72
620 320 04 28	23 320 428	STABILIZER KIT	72
620 320 06 28	63 450 476	STABILIZER KIT	73
620 323 00 50	63 451 217	STABILIZER MOUNTING	87
620 323 02 50	63 451 218	STABILIZER MOUNTING	87
620 323 03 50	63 450 421	STABILIZER BUSHING	71
620 490 03 65	21 490 365	EXHAUST METAL HOSE	302
620 490 04 65	21 490 465	EXHAUST METAL HOSE	302
620 492 02 08	24 492 208	EXHAUST CONNECTING PIECE	299
620 501 03 82	63 451 219	RADIATOR HOSE	347
620 501 28 82	63 451 220	RADIATOR HOSE	347
620 505 00 86	63 450 987	BOOT, FAN SHROUD	208
620 505 03 55	21 500 055	FAN SHROUD	314
620 505 06 55	21 500 155	FAN SHROUD	314
620 506 00 35	63 451 221	RADIATOR HOSE	348
620 506 03 35	63 451 222	RADIATOR HOSE	348

Umschlüsselung OEM / Cross Reference OEM

DB	AL-HU TECH	Description	Page
620 528 01 82	63 451 223	RADIATOR HOSE	348
620 540 00 45	25 226 727	STEERING COLUMN SWITCH	390
620 541 03 03	21 541 303	BATTERY COVER	202
620 553 03 82	63 450 741	CABIN HOSE	215
620 586 00 31	26 860 031	REPAIR KIT, CABIN MOUNTING	253
620 891 00 17	63 450 470	CABIN BUSHING	209
620 891 00 51	28 891 251	CABIN SPRING	221
620 891 01 51	28 891 351	CABIN SPRING	222
620 891 04 17	28 891 417	CABIN BUSHING	208
620 997 04 90	24 997 590	EXHAUST CLAMP 75 MM	298
620 997 05 90	24 997 690	EXHAUST CLAMP 90 MM	298
621 320 00 11	63 451 224	STABILIZER KIT	76
621 320 01 28	63 451 225	STABILIZER KIT	77
621 320 02 28	63 451 226	STABILIZER KIT	77
621 320 04 28	63 450 475	STABILIZER KIT	73
621 323 00 85	63 451 227	STABILIZER MOUNTING	87
621 490 00 65	21 490 565	EXHAUST FLEX METAL TUBE 113 MM	301
621 492 00 08	24 492 008	EXHAUST CONNECTING PIECE	299
621 997 00 90	24 997 790	EXHAUST CLAMP 100 MM	299
623 421 01 36	22 010 004	BRAKE CAMSHAFT	125
623 421 02 36	22 010 005	BRAKE CAMSHAFT	126
623 423 01 36	22 010 006	BRAKE CAMSHAFT	126
623 423 02 36	22 010 007	BRAKE CAMSHAFT	126
624 300 03 04	21 300 304	ACCELERATOR PEDAL KIT	278
624 320 00 28	63 450 477	STABILIZER KIT	73
624 325 01 12	63 451 669	SPRING SADDLE	65
624 325 02 19	23 325 219	SPRING SEAT	66
624 325 03 10	63 451 668	TRUNNION	91
624 325 03 19	23 325 319	SPRING SEAT	66
624 334 10 01	21 356 029	WHEEL HUB	98
624 356 00 20	21 114 086	HUB CAP	25
625 320 01 11	63 451 228	STABILIZER KIT	77
625 320 04 11	63 451 229	STABILIZER KIT	77
625 320 06 11	63 451 230	STABILIZER KIT	78
625 320 07 11	63 451 231	STABILIZER KIT	78
625 325 00 19	23 325 419	SPRING SEAT	66
625 325 01 19	23 325 519	SPRING SEAT	66
625 325 02 19	23 325 619	SPRING SEAT	67
625 325 03 19	23 325 719	SPRING SEAT	67
627 500 00 49	21 500 050	EXPANSION TANK	304
628 334 00 01	21 356 007	WHEEL HUB	97
629 330 00 07	63 451 066	BALL JOINT REPAIR KIT	11
629 330 01 07	63 451 232	BALL JOINT REPAIR KIT	14
631 330 14 49	63 451 233	REPAIR KIT STUB AXLE	34
634 326 00 81	63 451 234	STABILIZER MOUNTING	87
639 540 14 17	13 540 835	BRAKE WEAR INDICATOR	135
639 540 15 17	13 540 517	BRAKE WEAR INDICATOR	134
641 720 02 46	28 720 246	WINDOW LIFTER	260
641 720 03 46	28 720 346	WINDOW LIFTER	261
641 720 06 37	28 720 637	DOOR HINGE	229
641 720 07 37	28 720 737	DOOR HINGE	229
641 723 00 88	28 723 088	DOOR LEVER	230
641 723 00 88 35	28 723 088	DOOR LEVER	230
641 760 00 04	26 760 004	CABLE, DOOR CONTROL	222

Umschlüsselung OEM / Cross Reference OEM

DB	AL-HU TECH	Description	Page
641 760 02 59	28 760 259	DOOR HANDLE	226
641 760 03 59	28 760 559	DOOR HANDLE	226
641 760 04 59	28 761 459	DOOR HANDLE	228
641 760 05 59	28 761 559	DOOR HANDLE	228
641 810 00 12	28 810 012	MIRROR BEARING	249
641 810 01 12	28 810 012	MIRROR BEARING	249
641 810 02 14	28 810 214	MIRROR BRACKET	250
641 810 03 14	28 810 314	MIRROR BRACKET	250
641 811 01 07	63 451 235	MIRROR COVER	251
641 811 02 07	28 811 207	MIRROR COVER	251
641 811 03 26	28 811 326	MIRROR CONSOLE	251
641 830 04 61	28 830 461	HEAT EXCHANGER	246
641 988 05 35	28 827 012	BUMPER COVER	208
647 320 00 28	63 451 236	STABILIZER KIT	78
647 460 01 05	63 450 834	DRAG LINK	272
650 250 38 13	21 250 813	CLUTCH RELEASE LEVER	191
650 254 00 06	21 254 006	CLUTCH RELEASE AXLE	188
650 254 00 06 S	21 254 314	CLUTCH RELEASE SHAFT KIT	192
650 356 01 80	21 601 298	GASKET	23
650 528 00 91	21 528 291	RUBBER BELLOW, AIR INTAKE	354
652 320 05 11	63 451 237	STABILIZER KIT	78
652 350 03 06	23 350 122	CONTROL ARM	19
652 353 00 25	63 451 686	GROOVED NUT	24
652 501 24 82	63 451 238	RADIATOR HOSE	348
653 326 03 81	63 451 239	RUBBER MOUNTING	40
653 326 04 81	63 451 240	STABILIZER BUSHING	71
653 350 01 06	23 350 122	CONTROL ARM	19
653 353 00 50	616708	BUSH	16
654 350 05 06	27 350 506	CONTROL ARM	21
654 410 00 22	24 410 722	PROPELLER SHAFT BEARING	33
654 411 00 12	24 410 012	PROPELLER SHAFT BEARING	31
655 250 15 13	21 251 513	CLUTCH RELEASE LEVER	191
655 254 02 06	21 254 206	CLUTCH RELEASE AXLE	188
655 254 02 06 S	21 586 206	CLUTCH RELEASE AXLE KIT	189
655 290 30 13	25 000 004	CLUTCH HOSE	184
655 290 44 13	25 000 005	CLUTCH HOSE	184
655 320 01 11	63 451 241	STABILIZER KIT	79
655 326 04 81	63 451 242	STABILIZER BUSHING	72
655 326 05 81	23 326 681	STABILIZER MOUNTING	81
655 330 00 19	23 330 019	KING PIN SET	27
655 330 00 56	63 450 266	COVER	22
655 410 00 22	24 410 022	PROPELLER SHAFT BEARING	32
655 501 04 82	63 451 243	RADIATOR HOSE	349
655 501 12 82	63 451 244	RADIATOR HOSE	349
655 506 00 35	21 095 182	RADIATOR HOSE	345
655 528 01 82	21 528 182	RUBBER BELLOW, AIR INTAKE	354
655 540 00 45	25 226 907	STEERING COLUMN SWITCH	391
655 542 00 17	63 450 014	SENDER UNIT	387
655 553 05 82	26 000 000	CABIN HOSE	214
655 890 29 03	63 451 245	REPAIR KIT, CABIN MOUNTING	254
656 410 01 31	63 450 057	UNIVERSAL JOINT	93
656 411 00 12	63 450 005	PROPELLER SHAFT BEARING	33
656 411 02 12	63 450 005	PROPELLER SHAFT BEARING	33
656 501 14 82	63 451 246	RADIATOR HOSE	349

Umschlüsselung OEM / Cross Reference OEM

DB	AL-HU TECH	Description	Page
658 320 00 65	63 451 247	SPRING PIN KIT	65
658 350 02 05	23 351 205	CONTROL ARM	21
658 350 02 06	23 350 019	CONTROL ARM	18
658 421 00 74	63 450 824	SPRING RETAINING PIN	152
659 350 12 06	23 350 008	CONTROL ARM	18
659 350 13 06	23 350 006	CONTROL ARM	17
659 350 27 06	23 350 014	CONTROL ARM	18
659 350 27 06	27 350 706	CONTROL ARM	269
659 350 32 06	23 350 206	CONTROL ARM	268
659 350 34 06	23 350 120	CONTROL ARM	19
659 350 35 06	23 350 008	CONTROL ARM	18
659 350 39 06	23 350 007	CONTROL ARM	17
659 420 03 19	24 420 319	BRAKE SHOE	129
659 420 05 19	24 420 519	BRAKE SHOE	129
659 420 14 44	23 201 444	DUST COVER	141
659 420 15 44	23 201 444	DUST COVER	141
659 420 16 44	24 420 644	DUST COVER	141
659 420 17 44	24 420 644	DUST COVER	141
659 990 00 01	21 990 001	SCREW	55
667 317 00 12	63 451 248	RUBBER MOUNTING	41
667 317 02 36	63 451 249	RUBBER MOUNTING	41
667 320 00 44	63 451 250	RUBBER MOUNTING	41
667 320 00 73	63 451 251	RUBBER MOUNTING	41
667 320 00 77	63 451 252	RUBBER MOUNTING	42
667 323 03 85	63 451 253	RUBBER MOUNTING	42
667 323 04 85	63 451 254	RUBBER MOUNTING	42
667 326 01 81	63 451 255	RUBBER MOUNTING	42
667 326 14 40	63 451 256	RUBBER MOUNTING	43
667 326 14 81	63 451 257	RUBBER MOUNTING	43
667 545 00 13	24 545 013	IGNITION SWITCH	247
667 545 01 08	25 545 108	IGNITION SWITCH	248
668 242 00 13	21 242 013	RUBBER MOUNTING	35
668 242 05 13	21 242 513	RUBBER MOUNTING	35
668 350 00 35	21 356 030	WHEEL HUB	98
669 540 04 17	13 540 041	BRAKE WEAR INDICATOR	132
669 540 07 17	13 540 073	BRAKE WEAR INDICATOR	133
669 540 08 17	13 540 081	BRAKE WEAR INDICATOR	133
669 540 09 17	13 540 917	BRAKE WEAR INDICATOR	135
670 320 03 44	63 451 258	RUBBER MOUNTING	43
670 320 04 44	63 451 259	RUBBER MOUNTING	43
670 330 02 19	63 451 260	KING PIN SET	28
670 540 00 17	13 540 001	BRAKE WEAR INDICATOR	131
670 760 01 59	28 766 901	DOOR HANDLE	229
670 760 02 05	28 760 659S	DOOR HANDLE	227
670 760 02 05	28 760 759S	DOOR HANDLE	227
670 760 02 05	28 760 205	LOCKING CYLINDER WITH KEYS	249
673 290 04 39	25 290 439	ROD, MASTER CYLINDER	197
673 320 00 50	63 451 261	SPRING BUSHING	62
673 320 01 50	63 451 262	SPRING BUSHING	62
673 320 02 50	63 451 263	SPRING BUSHING	62
673 323 03 85	63 451 264	RUBBER MOUNTING	44
673 324 01 50	63 451 265	STABILIZER MOUNTING	88
673 324 04 08	63 451 266	RUBBER MOUNTING	44
673 325 01 44	63 451 267	RUBBER MOUNTING	44

Umschlüsselung OEM / Cross Reference OEM

DB	AL-HU TECH	Description	Page
673 325 02 84	63 451 268	RUBBER MOUNTING	44
673 326 06 81	63 451 269	RUBBER MOUNTING	45
673 356 12 02	21 356 004	WHEEL HUB	96
673 490 00 65	21 490 065	EXHAUST FLEX METAL TUBE	300
673 490 02 65	21 490 165	EXHAUST FLEX METAL TUBE	300
673 540 04 45	25 226 681	STEERING COLUMN SWITCH	390
673 720 00 75	28 720 075	HANDLE, INSIDE, SLIDING DOOR	236
673 760 00 02	28 760 002	WINDOW HANDLE BLACK	259
673 760 00 02	28 760 003	WINDOW HANDLE GREY	259
673 993 04 10	63 451 270	BRAKE SHOE SPRING	131
674 317 08 12	63 451 271	RUBBER MOUNTING	45
674 325 02 44	63 451 272	RUBBER MOUNTING	45
674 325 03 44	63 451 273	RUBBER MOUNTING	45
674 356 02 26	21 356 226	GROOVED NUT	24
674 402 01 71	63 451 274	WHEEL BOLT	94
674 490 00 65	21 490 665	EXHAUST METAL HOSE	303
674 500 00 49	63 451 434	EXPANSION TANK	305
675 320 00 50	63 451 275	SPRING BUSHING	63
675 320 01 50	63 451 276	SPRING BUSHING	63
675 323 04 85	63 451 277	RUBBER MOUNTING	46
675 323 13 85	23 324 085	STABILIZER BUSHING	69
675 323 14 85	63 451 278	RUBBER MOUNTING	46
675 323 18 85	63 451 279	RUBBER MOUNTING	46
675 323 19 85	63 451 280	RUBBER MOUNTING	46
675 323 23 85	63 451 281	RUBBER MOUNTING	47
675 324 00 08	63 451 282	RUBBER MOUNTING	47
675 325 01 44	63 451 283	RUBBER MOUNTING	47
675 325 05 85	63 451 284	RUBBER MOUNTING	47
675 326 05 81	63 451 285	RUBBER MOUNTING	48
675 326 09 81	63 451 286	RUBBER MOUNTING	48
675 326 12 81	63 451 287	RUBBER MOUNTING	48
675 330 19 19	63 451 288	KING PIN SET	28
676 323 00 85	63 451 289	RUBBER MOUNTING	48
677 540 07 17	13 540 072	BRAKE WEAR INDICATOR	133
677 540 08 17	13 540 817	BRAKE WEAR INDICATOR	135
684 325 00 17	63 451 682	HELPER SPRING BRACKET	25
697 987 01 39	21 500 101	RADIATOR MOUNTING	351
900 271 05 50 00	21 203 030	HOSE	326
901 241 25 13	63 451 290	RUBBER MOUNTING	49
901 300 10 30	21 300 030	ACCELERATION CABLE	278
901 300 16 30	21 301 030	ACCELERATION CABLE	278
901 300 17 30	21 301 030	ACCELERATION CABLE	278
901 322 04 19	63 451 291	RUBBER MOUNTING	49
901 322 21 19	63 451 292	RUBBER MOUNTING	49
901 322 22 19	63 451 293	RUBBER MOUNTING	49
901 322 26 19	63 451 294	RUBBER MOUNTING	50
901 323 01 85	63 451 295	RUBBER MOUNTING	50
901 323 02 85	63 451 296	RUBBER MOUNTING	50
901 323 02 88	63 451 297	RUBBER MOUNTING	50
901 325 01 44	63 451 298	RUBBER MOUNTING	51
901 326 00 81	63 451 299	RUBBER MOUNTING	51
901 333 02 14	63 451 300	RUBBER MOUNTING	51
901 462 03 79	14 462 327	LOCK CYLINDER	248
901 500 05 54	11 831 770	CONDENSOR	288

Umschlüsselung OEM / Cross Reference OEM

DB	AL-HU TECH	Description	Page
901 540 00 17	13 540 117	BRAKE WEAR INDICATOR	133
901 540 01 17	13 540 117	BRAKE WEAR INDICATOR	133
901 540 02 17	13 540 021	BRAKE WEAR INDICATOR	132
901 540 03 17	13 540 021	BRAKE WEAR INDICATOR	132
901 542 08 17	13 927 001	ABS SENSOR	101
901 542 11 17	13 927 002	ABS SENSOR	101
901 542 17 17	13 927 001	ABS SENSOR	101
901 720 14 46	28 720 446	WINDOW LIFTER	261
901 720 15 46	28 720 546	WINDOW LIFTER	261
901 750 03 59	28 750 359	CABLE ENGINE HOOD	222
901 760 01 04	28 760 104	CABLE, DOOR CONTROL	222
901 760 04 59	28 760 459	HANDLE, DOOR AND SLIDING DOOR	235
901 760 10 47	28 760 047	SLIDING UNIT, UPPER RIGHT,	256
901 760 13 47	28 760 347	SLIDING UNIT, UPPER, RIGHT	256
901 760 13 61	18 760 361	DOOR HANDLE	224
904 010 38 13	28 010 813	OIL PAN	337
904 030 03 20	21 031 320	CONROD	292
904 140 00 63	21 140 046	THROTTLE VALVE KIT	360
904 200 00 04	21 200 042	WATER PUMP KIT	374
904 200 08 22	21 200 522	FAN CLUTCH	312
904 200 25 01	21 200 401	WATER PUMP	372
904 200 49 01	21 200 401	WATER PUMP	372
904 205 01 06	63 451 133	FAN BLADE	309
904 205 04 06	21 205 046	FAN BLADE	307
904 323 00 85	63 451 301	RUBBER MOUNTING	51
904 326 08 81	63 451 302	RUBBER MOUNTING	52
904 326 10 81	63 451 303	RUBBER MOUNTING	52
904 990 04 12	63 451 409	SCREW	355
906 010 13 13	21 010 313	OIL PAN	337
906 030 02 20	21 030 021	CONROD	290
906 030 03 20	21 030 121	CONROD	290
906 030 19 05	21 030 905	FLYWHEEL	318
906 030 20 05	28 030 022	FLYWHEEL	320
906 030 32 05	21 030 906	FLYWHEEL	318
906 052 14 03	63 450 573	CRANKSHAFT GEAR	294
906 054 07 01	21 054 701	VALVE TAPPET	366
906 180 17 10	63 451 417	OIL FILTER HOUSING	335
906 200 08 22	21 200 822	FAN CLUTCH	313
906 200 12 70	21 200 574	BELT TENSIONER	282
906 200 18 22	21 200 822	FAN CLUTCH	313
906 200 18 70	21 200 582	BELT TENSIONER	283
906 200 20 70	21 200 470	BELT TENSIONER	281
906 200 22 70	21 200 575	BELT TENSIONER	283
906 200 44 70	21 200 971	BELT TENSIONER PULLEY	285
906 200 57 01	21 200 043	WATER PUMP	370
906 200 59 70	21 200 972	BELT TENSIONER	284
906 200 61 01	21 200 043	WATER PUMP	370
906 200 65 01	21 200 043	WATER PUMP	370
906 202 09 10	63 451 406	V-BELT PULLEY	368
906 205 04 06	21 205 008	FAN BLADE	307
906 205 09 06	21 205 008	FAN BLADE	307
906 323 16 85	63 451 304	RUBBER MOUNTING	52
906 500 00 54	21 830 054	CONDENSOR	289
906 540 13 17	13 540 320	BRAKE WEAR INDICATOR	134

Umschlüsselung OEM / Cross Reference OEM

DB	AL-HU TECH	Description	Page
906 540 14 17	13 540 838	BRAKE WEAR INDICATOR	135
906 540 15 17	13 540 838	BRAKE WEAR INDICATOR	135
913 004 01 60 05	AM 16X1.5	HEX LOCK NUT	154
940 317 10 12	28 317 012	RUBBER BUFFER, CABIN MOUNTING,	255
940 317 11 12	28 317 112	RUBBER BUFFER, CABIN MOUNTING	254
940 501 00 03	21 500 849	EXPANSION TANK	305
940 501 07 82	21 501 782	RADIATOR HOSE	346
940 501 09 82	21 501 982	RADIATOR HOSE	346
940 528 09 82	21 528 982	RUBBER BELLOW, AIR INTAKE	355
940 820 01 61	28 820 162	HEAD LAMP	236
940 820 02 21	28 820 221	BLINKER LAMP	202
940 820 02 61	28 820 262	HEAD LAMP	237
940 820 03 21	28 820 321	BLINKER LAMP	202
940 820 04 21	28 820 421	BLINKER LAMP	203
940 835 02 47	28 835 247	CABIN FILTER	213
941 241 57 13	21 000 008	RUBBER MOUNTING	35
941 241 76 13	23 323 354	RUBBER MOUNTING	37
941 241 82 13	21 241 213	ENGINE MOUNTING	22
941 241 87 13	21 241 713	ENGINE MOUNTING	23
941 323 00 50	23 323 353	STABILIZER BUSHING	69
941 323 01 50	23 323 356	STABILIZER MOUNTING	80
941 323 03 50	23 323 350	STABILIZER BUSHING	69
941 326 00 50	23 323 355	BUSHING	16
941 326 03 50	63 450 133	STABILIZER MOUNTING	82
941 330 01 03	23 330 003	TIE ROD	275
941 330 02 03	23 330 003	TIE ROD	275
941 501 03 82	21 501 382	RADIATOR HOSE	345
941 501 05 82	21 501 582	RADIATOR HOSE	345
941 501 07 82	63 451 305	RADIATOR HOSE	349
941 501 12 82	63 451 306	RADIATOR HOSE	350
941 522 00 67	28 522 067	RUBBER FOR FENDER	255
941 522 01 67	28 522 167	RUBBER FOR FENDER	255
941 540 05 45	28 540 545	SWITCH, SHIFT KNOB	392
941 541 00 03	26 541 103	BATTERY COVER	202
941 541 01 03	26 541 103	BATTERY COVER	202
941 671 01 20	753158111	WEATHERSTRIP	258
941 720 00 66	28 720 066	DOOR CONTROL	224
941 720 01 66	28 720 166	DOOR CONTROL	224
941 720 04 46	28 720 646	WINDOW LIFTER	261
941 720 05 46	28 720 746	WINDOW LIFTER	262
941 723 01 20	26 723 120	DOOR CHECK	223
941 760 04 59	28 760 759	DOOR HANDLE	227
941 760 04 59	28 760 759S	DOOR HANDLE	227
941 760 05 59	28 760 659	DOOR HANDLE	226
941 760 05 59	28 760 659S	DOOR HANDLE	227
941 820 05 21	63 450 108	BLINKER LAMP	204
941 820 09 21	63 450 109	BLINKER LAMP	204
941 820 10 21	26 820 021	BLINKER LAMP	203
941 820 33 61	63 450 189	HEAD LAMP	242
941 820 34 61	63 450 190	HEAD LAMP	242
941 820 43 61	28 820 361	HEAD LAMP	237
941 820 44 61	28 820 461	HEAD LAMP	237
941 820 51 61	28 821 161	HEAD LAMP	238
941 820 52 61	28 821 261	HEAD LAMP	239

Umschlüsselung OEM / Cross Reference OEM

DB	AL-HU TECH	Description	Page
941 820 53 61	28 826 361	HEAD LAMP	240
941 820 54 61	28 826 461	HEAD LAMP	241
941 820 55 61	28 820 961	HEAD LAMP	238
941 820 56 61	28 821 061	HEAD LAMP	238
941 820 57 61	28 826 761	HEAD LAMP	241
941 820 58 61	28 826 861	HEAD LAMP	241
941 820 61 61	28 820 161	HEAD LAMP	236
941 820 62 61	28 820 261	HEAD LAMP	236
941 880 00 20	28 827 014	HANDLE	235
941 890 01 70	26 890 170	CABLE, STORAGE BOX	223
941 890 04 72	28 891 472	HANDLE	235
941 890 05 72	28 891 572	HANDLE	235
942 310 00 49	63 450 544	BUSHING	17
942 310 02 83	28 618 283	CABIN LOCK	215
942 310 03 83	28 618 383	CABIN LOCK	216
942 310 04 83	28 618 483	CABIN LOCK	216
942 317 18 12	63 450 181	CABIN BUSHING	209
942 317 20 12	28 317 212	RUBBER BUFFER, CABIN MOUNTING	254
942 317 21 12	28 317 312	RUBBER BUFFER, CABIN MOUNTING	255
942 317 22 12	63 451 307	RUBBER MOUNTING	52
942 317 23 12	63 450 472	CABIN BUSHING	209
942 326 00 50	23 323 357	BUSHING	16
942 330 01 03	23 330 403	TIE ROD	91
942 330 04 03	23 330 103	TIE ROD	90
942 330 05 03	23 330 203	TIE ROD	90
942 330 09 03	23 330 203	TIE ROD	90
942 330 11 03	23 330 403	TIE ROD	91
942 332 00 06	63 450 259	KING PIN	26
942 332 03 62	63 451 419	THRUST WASHER	90
942 334 12 01	21 356 002	WHEEL HUB	95
942 334 14 01	21 356 036	WHEEL HUB	99
942 350 05 05	23 350 805	CONTROL ARM	21
942 350 08 05	23 350 805	CONTROL ARM	21
942 350 11 05	23 351 105	CONTROL ARM	21
942 401 02 71	63 451 308	WHEEL BOLT	95
942 401 03 71	63 451 309	WHEEL BOLT	95
942 421 21 12	22 421 001	BRAKE DISC	127
942 490 00 41	63 451 310	EXHAUST CLAMP	297
942 490 01 41	63 451 311	EXHAUST CLAMP	297
942 490 20 19	21 490 219	EXHAUST PIPE	303
942 490 22 19	21 490 765	EXHAUST PIPE	304
942 490 28 19	21 490 819	EXHAUST FLEX METAL TUBE	300
942 490 30 19	21 490 019	EXHAUST PIPE	303
942 490 31 19	21 490 119	EXHAUST PIPE	303
942 490 36 19	21 490 319	EXHAUST PIPE	304
942 500 00 50	28 500 050	STABILIZER BUSHING	70
942 500 00 54	21 830 154	CONDENSOR	289
942 500 01 54	21 830 154	CONDENSOR	289
942 501 05 82	21 095 282	RADIATOR HOSE	345
942 501 15 82	63 451 312	RADIATOR HOSE	350
942 504 02 14	23 326 091	RUBBER MOUNTING	37
942 505 09 55	28 827 013	FAN SHROUD	232
942 506 15 35	63 451 313	RADIATOR HOSE	350
942 506 32 35	63 451 314	RADIATOR HOSE	350

Umschlüsselung OEM / Cross Reference OEM

DB	AL-HU TECH	Description	Page
942 528 00 91	21 528 091	RUBBER BELLOW, AIR INTAKE	354
942 528 03 82	21 528 382	RUBBER BELLOW, AIR INTAKE	355
942 542 02 17	63 450 012	SENDER UNIT	386
942 553 01 82	63 450 740	CABIN HOSE	215
942 553 28 82	63 450 743	CABIN HOSE	215
942 890 02 19	63 450 025	CABIN SHOCK ABSORBER	220
942 890 05 19	63 450 024	SHOCK ABSORBER	58
942 890 28 19	28 890 053	CABIN SHOCK ABSORBER	220
942 890 29 19	28 890 001	CABIN SHOCK ABSORBER	220
942 890 31 19	28 890 054	CABIN SHOCK ABSORBER	220
942 890 47 19	63 450 042	SHOCK ABSORBER	60
942 890 53 19	63 450 026	SHOCK ABSORBER	59
942 890 56 19	63 450 025	CABIN SHOCK ABSORBER	220
942 890 60 19	63 450 025	CABIN SHOCK ABSORBER	220
942 997 00 90	63 451 315	EXHAUST CLAMP	298
942 997 02 90	63 451 316	EXHAUST CLAMP	298
943 330 11 25	21 356 016	WHEEL HUB	97
943 351 01 25	63 450 075	U-BOLT	94
943 760 01 59	28 761 159	DOOR HANDLE	227
943 760 02 59	28 761 259	DOOR HANDLE	228
943 820 00 56	28 826 056	FOG LAMP	233
943 820 01 56	28 826 156	FOG LAMP	233
943 820 01 61	28 826 161	HEAD LAMP	240
943 820 02 61	28 826 261	HEAD LAMP	240
943 820 03 61	28 821 361	HEAD LAMP	239
943 820 04 61	28 821 461	HEAD LAMP	239
943 820 05 61	63 450 180	HEAD LAMP	242
943 820 06 61	63 450 147	HEAD LAMP	241
943 820 08 61	63 450 148	HEAD LAMP	242
943 820 14 61	63 450 218	HEAD LAMP	243
943 820 15 61	63 450 219	HEAD LAMP	243
943 820 16 61	63 450 224	HEAD LAMP	243
943 820 17 61	63 450 225	HEAD LAMP	243
943 820 22 61	63 450 226	HEAD LAMP	244
943 820 23 61	63 450 227	HEAD LAMP	244
943 890 03 19	63 450 182	CABIN SHOCK ABSORBER	221
943 890 09 19	28 890 054	CABIN SHOCK ABSORBER	220
943 890 39 19	63 450 025	CABIN SHOCK ABSORBER	220
944 330 02 03	63 450 562	DRAG LINK	272
944 350 05 05	23 350 405	CONTROL ARM	20
944 350 06 05	23 350 405	CONTROL ARM	20
945 330 02 03	23 330 303	TIE ROD	275
945 350 01 05	23 350 105	CONTROL ARM	18
945 420 02 38	24 420 338	SLACK ADJUSTER	150
945 420 03 38	24 420 238	SLACK ADJUSTER	149
945 420 04 38	24 420 438	SLACK ADJUSTER	150
945 420 09 38	24 420 938	SLACK ADJUSTER	150
945 421 00 74	63 451 317	BOLT	125
945 993 00 10	63 451 318	BRAKE SHOE SPRING	131
946 356 00 15	23 356 015	PRESSURE RING	30
946 356 02 01	21 356 032	WHEEL HUB	98
946 356 07 01	21 356 033	WHEEL HUB	98
947 325 00 50	21 325 050	RUBBER MOUNTING	36
947 350 01 05	23 350 119	CONTROL ARM	19

Umschlüsselung OEM / Cross Reference OEM

DB	AL-HU TECH	Description	Page
947 350 10 05	23 350 119	CONTROL ARM	19
948 350 04 05	23 350 405	CONTROL ARM	20
948 350 12 05	23 350 205	CONTROL ARM	20
948 350 22 05	23 350 105	CONTROL ARM	18
948 350 23 05	23 350 123	CONTROL ARM	19
948 350 24 05	23 350 908	CONTROL ARM	268
948 350 25 05	23 350 105	CONTROL ARM	18
948 350 30 05	23 350 127	CONTROL ARM	20
949 320 00 73	63 451 319	SPRING SHACKLE BUSHING	67
949 330 02 03	63 450 561	DRAG LINK	272
949 330 04 03	63 450 560	DRAG LINK	271
949 330 09 03	63 450 561	DRAG LINK	272
949 330 23 03	63 450 560	DRAG LINK	271
949 334 08 01	21 356 034	WHEEL HUB	99
970 260 02 98	63 451 320	REPAIR KIT GEARBOX SHIFT	196
970 290 00 93	28 290 093	REPAIR KIT	352
970 310 01 73	26 310 173	LEVER, CABIN LOCKING	248
970 317 01 12	63 451 321	RUBBER MOUNTING	53
970 320 00 44	63 450 144	STABILIZER MOUNTING	82
970 320 01 44	63 451 322	RUBBER MOUNTING	53
970 320 03 44	63 451 323	RUBBER MOUNTING	53
970 323 12 85	63 451 324	RUBBER MOUNTING	53
970 323 14 85	63 451 325	RUBBER MOUNTING	54
970 323 15 85	63 451 326	RUBBER MOUNTING	54
970 323 17 85	23 324 185	STABILIZER BUSHING	69
970 323 20 85	63 451 327	RUBBER MOUNTING	54
970 350 03 35	21 356 041	WHEEL HUB	99
970 410 00 31	63 450 020	UNIVERSAL JOINT	93
970 500 04 49	63 451 441	EXPANSION TANK	306
973 410 00 22	24 410 622	PROPELLER SHAFT BEARING	32
973 411 00 12	24 410 027	PROPELLER SHAFT BEARING	32
973 720 01 35	28 721 135	DOOR LOCK	231
973 720 01 46	28 722 146	WINDOW LIFTER	263
973 720 02 35	28 721 235	DOOR LOCK	231
973 720 02 46	28 722 246	WINDOW LIFTER	263
973 720 03 46	28 722 346	WINDOW LIFTER	263
973 720 04 46	28 722 446	WINDOW LIFTER	264
973 720 07 35	28 720 735	DOOR LOCK	230
973 720 08 35	28 720 835	DOOR LOCK	231
973 750 03 51	28 750 351	HINGE, BONNET, LEFT	246
973 750 04 51	28 750 451	HINGE, BONNET, RIGHT	247
973 820 01 21	63 451 399	BLINKER LAMP	204
973 820 01 61	28 822 161	HEAD LAMP	239
973 820 02 61	28 822 261	HEAD LAMP	240
973 820 03 21	28 826 321	BLINKER LAMP	203
973 820 04 21	28 826 421	BLINKER LAMP	203
973 820 05 61	28 820 561	HEAD LAMP	237
973 820 06 61	28 820 661	HEAD LAMP	238
974 320 00 44	63 451 328	RUBBER MOUNTING	54
974 323 03 85	63 451 329	RUBBER MOUNTING	55
974 328 01 81	63 451 330	RUBBER MOUNTING	55
975 330 04 25	21 356 017	WHEEL HUB	97
976 356 11 01	21 356 001	WHEEL HUB	95

Garantie

Alle ALHU-tech-Produkte sind im Bezug auf Materialfehler und Fertigungsmängel garantiert. Diese Garantie beschränkt sich ausschließlich auf den Ersatz des fehlerhaften Bestandteils. Wir übernehmen keine Haftung für Schäden, die sich aufgrund von Missbrauch, Vernachlässigung, Unfall, Abnutzung und Verschleiß ergeben. Alle Verluste und Folgeschäden sind ausdrücklich ausgeschlossen. Forderungen bezüglich Schäden oder Unstimmigkeiten hinsichtlich von Produktlieferungen der Firma ALHU Fahrzeugtechnik GmbH sind unmittelbar und schriftlich vorzulegen. Dieser Katalog enthält das komplette ALHU-tech-Programm an Automobil-Elektroteilen und dient als Leitfaden der möglichen Einsatzbereiche. Obwohl wir bei der Erstellung dieser Angaben höchste Sorgfalt angewandt haben, können wir keine Gewähr für die absolute Richtigkeit der Informationen abgeben. Technische und konstruktive Produktänderungen können im Laufe der Gültigkeit dieses Katalogs erforderlich sein, so dass sich möglicherweise Unterschiede zwischen den ursprünglichen Abbildungen und tatsächlich gelieferten Produkten ergeben.

Guarantee

All ALHU-tech products are guaranteed against defects arising from faulty materials or workmanship. The guarantee is limited to the replacement of the faulty part; we cannot extend the guarantee to cover defects caused by misuse, neglect, accident or wear and tear. We cannot accept liability for consequential loss or damage which is claimed to have resulted from use of one of our products. Claims resulting from damage or discrepancies during delivery of goods from ALHU Fahrzeugtechnik GmbH must be made without delay and reported in writing. This catalogue shows the range of ALHU-tech auto-electrical parts and is a guide to the vehicles to which they apply. Whilst great care has been taken in the preparation of the catalogue we cannot guarantee the complete accuracy of this information. In some instances technical and design changes may be necessary during the life of this catalogue which may result in some difference between the original illustrations and products currently supplied.

Garantie

Toutes les pièces ALHU-tech figurant dans ce catalogue sont garanties contre tout vice de fabrication. La garantie est limitée au remplacement du produit défectueux, la garantie ne couvre pas des défauts résultants d'abus, négligence, accident ou usure. Nous ne pouvons pas accepter la responsabilité pour des pertes ou dégâts résultants de l'emploi de nos produits. Les réclamations résultants de produit endommagé ou manquant au livraison doivent être communiquées sans délai et par écrit à ALHU Fahrzeugtechnik GmbH. Les références, numéros d'origine ou autres, étrangers aux numéros propres de ALHU-tech ne sont portés qu'à titre indicatif et ne peuvent en aucun cas donner matière à confusion. De temps en temps des modifications techniques peuvent être nécessaires, résultant dans des différences entre les illustrations et les produits fournis.

Garanzia

Tutti i prodotti ALHU-tech sono garantiti da difetti derivanti da materiali non conformi o da cattiva esecuzione. La garanzia è limitata alla sostituzione delle parti difettate; la garanzia non vale per difetti causati da utilizzo improprio, danni a usura. Non ci riteniamo responsabili per eventuali difetti o danni derivanti da un cattivo utilizzo dei nostri prodotti.

Eventuali reclami per danni o difetti causati durante il trasporto dalla ALHU Fahrzeugtechnik GmbH ci devono pervenire per tempo e per iscritto.

Il presente catalogo illustra la gamma delle parti elettriche delle automobili ALHU-tech ed è una guida per i veicoli a cui esse vanno applicate.

Nonostante il catalogo sia stato preparato con grande accuratezza, non garantiamo l'esattezza delle informazioni contenute.

Per alcuni modelli potrebbero essere necessarie delle modifiche o di design, perciò potrebbero riscontrarsi delle differenze tra le illustrazioni originarie ed i prodotti forniti dopo la distribuzione del catalogo.

Garantia

Todos os produtos da ALHU-tech tem garantia contra defeito de material ou de mau-de-obra. A garantia limita-se a troca da peça defeituosa e não podemos estender a garantia a defeitos provocados por mau uso, negligência, acidente ou desgaste. Também não podemos tomar a responsabilidade por qualquer perda ou dano que se pretenda tenha resultado do uso de qualquer dos nossos produtos. Reclamações sobre danos ou faltas na entrega, devem ser feitas o mais rápido possível e por escrito.

Este catálogo apresenta a gama de peças auto-elétricas da ALHU-tech e, é um guia para os automóveis nas quais se aplicam. Embora tenha sido prestado o maior cuidado na compilação deste catálogo, não podemos garantir a sua completa exactitude.

Em alguns casos, alterações técnicas ou ilustrativas podem ser necessárias durante a existência deste catálogo, as quais poderão resultar em diferenças entre as ilustrações e os produtos fornecidos actualmente.

Garantía

Todos los productos de ALHU-tech estan garantizados contra defectos de material o de mano de obra - la garantía se limita al cambio de la pieza defectuosa, no podemos extender la garantía a defectos causados por mal uso, negligencia, accidente o desgaste - tampoco podemos aceptar responsabilidad por cualquier pérdida o daño que se pretenda haya resultado en el uso de cualquiera de nuestros productos. Reclamaciones, sobre daños o faltas en las entregas, deberan hacerse sin perdida de tiempo y por escrito.

Este catálogo muestra la gama de las piezas autoeléctricas de ALHU-tech y es una guía para los automóviles a los cuales se aplican. Si bien se ha prestado mucha atención, no podemos garantizar su completa exactitud.

En algunos casos, cambios técnicos o en el diseño, pueden ser necesarios durante la existencia de este catálogo, lo cual puede resultar en diferencias entre las ilustraciones y los productos suministrados actualmente.

Auszug aus unseren Allgemeinen Lieferungs- und Garantiebedingungen.

Gültig für Angebote, Verkäufe und Lieferungen.

Angebote sind freibleibend und ohne Verbindlichkeit für uns. Wenn nicht anders vereinbart, verstehen sich alle Preise netto, ab Werk einschließlich Verpackung.

Es werden die am Tage der Lieferung gültigen Preise berechnet. Bei Sonderanfertigungen sind Ober- oder Unterlieferungen bis zu 10% der bestellten Menge zulässig.

Mängelrügen gegen Gewicht, Stückzahl, Güte oder Ausführung der Ware können nur berücksichtigt werden, wenn sie unverzüglich mitgeteilt werden. Wir garantieren für gute Qualität und sorgfältige Ausführung der gelieferten Ware auf die Dauer von zwölf Monaten (ab Versanddatum gerechnet). Diese Garantie erstreckt sich auf Material- und Fabrikationsfehler, die sich im Laufe dieses Zeitabschnittes zeigen. Wir verpflichten uns, während der Dauer der Garantie defekte Teile kostenlos instand zu setzen, zu ersetzen oder zu vergüten.

Unsere Garantie erstreckt sich nicht über den natürlichen Verschleiß von Bestandteilen sowie Schäden noch deren Folgen, welche durch falsche Bedienung, Nachlässigkeit, übermäßige Beanspruchung verursacht werden. Unsere gesamte Garantie erlischt sofort, wenn Änderungen oder Reparaturen ohne Zustimmung vorgenommen werden. Zeichnungen, Unterlagen und Entwürfe unserer Firma dürfen vom Empfänger irgendwelchen dritten Personen nicht bekannt gegeben werden.

Sämtliche Angaben dieses Kataloges sind mit größter Sorgfalt zusammengestellt worden, und sind - soweit wir feststellen können - richtig. Irgendwelche Ersatzansprüche aufgrund unserer Katalogangaben können jedoch nicht anerkannt werden. Hinweise auf Fehler sind uns stets willkommen.

Nachdruck

Auch auszugsweise nicht gestattet: Alle Rechte, insbesondere die der Vervielfältigung, sowie der Speicherung auf Datenträgern - auch auszugsweise - bleiben vorbehalten.

Wichtiger Hinweis

Teile-Nummern anderer Hersteller sind ausschließlich zu Vergleichszwecken aufgeführt. Diese dürfen in Rechnungen an Endverbraucher nicht verwendet werden.

ALHU Fahrzeugtechnik GmbH, D-22301 Hamburg