

**spare parts for**

---

**Mercedes Benz**

Achse / Axle

**63 451 424 BOOT KIT**



W 123 W 126

**Mercedes Benz**  
126 350 03 37

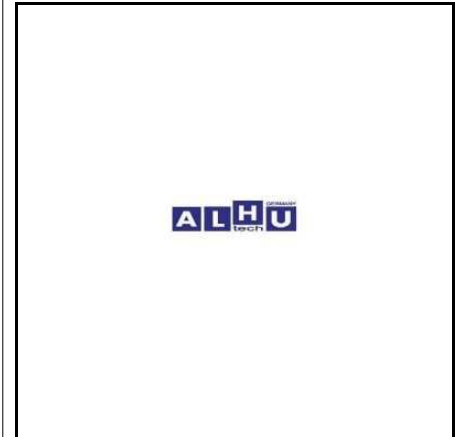

**63 451 425 BOOT KIT**



W 140

**Mercedes Benz**  
140 350 11 37

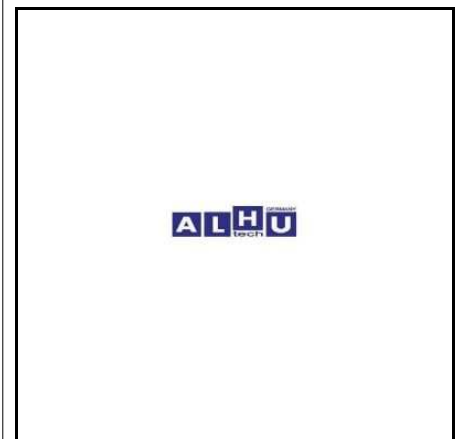

**63 451 426 BOOT KIT**



**Mercedes Benz**  
210 357 00 91  
210 357 01 91

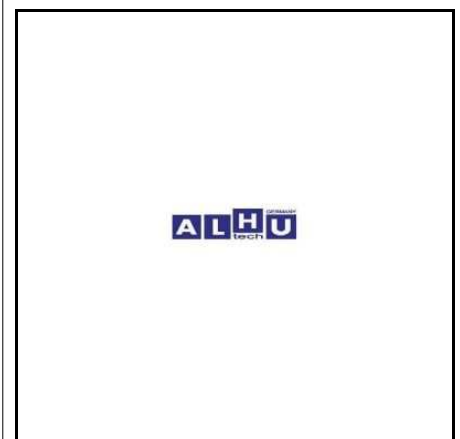

**11 000 007 ENGINE MOUNTING**

**Mercedes Benz**  
124 240 15 17

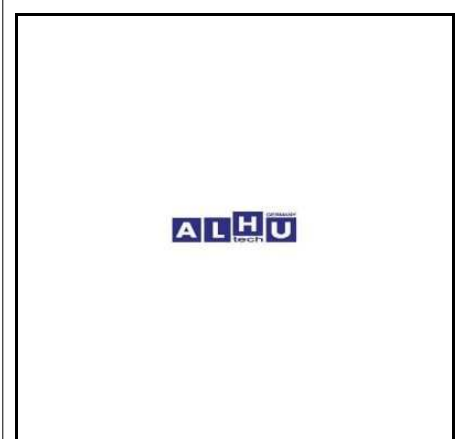

Achse / Axle

**11 000 008 ENGINE MOUNTING**

**Mercedes Benz**  
124 240 22 17



**11 000 026 ENGINE MOUNTING**

**Mercedes Benz**  
140 240 02 17



**11 000 027 ENGINE MOUNTING**

**Mercedes Benz**  
140 240 09 18



**11 000 028 ENGINE MOUNTING**

**Mercedes Benz**  
140 240 22 17



Achse / Axle

**11 000 038 ENGINE MOUNTING**

**Mercedes Benz**  
202 240 16 17



**11 000 039 ENGINE MOUNTING**

**Mercedes Benz**  
202 240 17 17



**11 000 040 ENGINE MOUNTING**

**Mercedes Benz**  
202 240 28 17



**11 000 044 ENGINE MOUNTING**

**Mercedes Benz**  
203 240 05 17



Achse / Axle

**11 240 003 ENGINE MOUNTING**

**Mercedes Benz**  
124 240 17 17  
201 240 40 17



**11 240 004 ENGINE MOUNTING**

**Mercedes Benz**  
124 240 19 17  
201 240 43 17



**11 240 005 ENGINE MOUNTING**

**Mercedes Benz**  
124 240 26 17



**11 240 006 ENGINE MOUNTING**

**Mercedes Benz**  
140 240 21 17



Achse / Axle

**11 240 007 ENGINE MOUNTING**

**Mercedes Benz**  
140 240 20 17

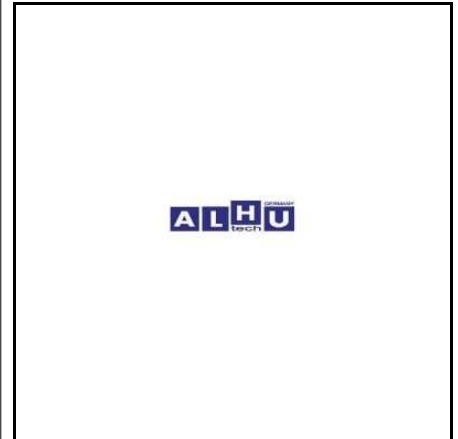

**11 240 008 ENGINE MOUNTING**

**Mercedes Benz**  
203 240 06 17



**11 240 009 ENGINE MOUNTING**

**Mercedes Benz**  
210 240 01 17

**LMI**  
1134502

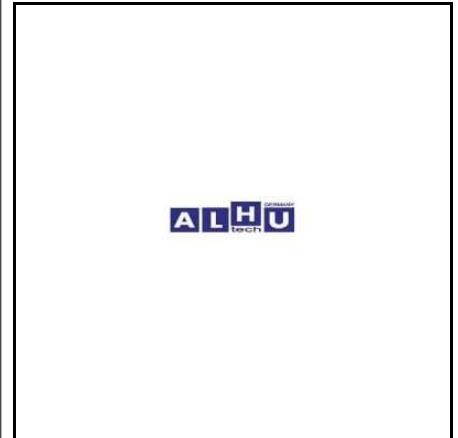

**11 240 010 ENGINE MOUNTING**

**Mercedes Benz**  
210 240 02 17

**LMI**  
1134602

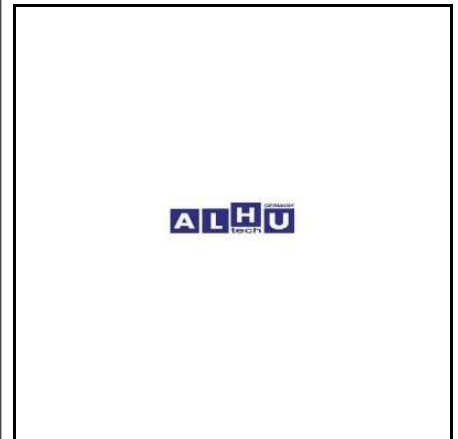

Achse / Axle

**11 240 012 ENGINE MOUNTING**

**Mercedes Benz**  
220 240 06 17

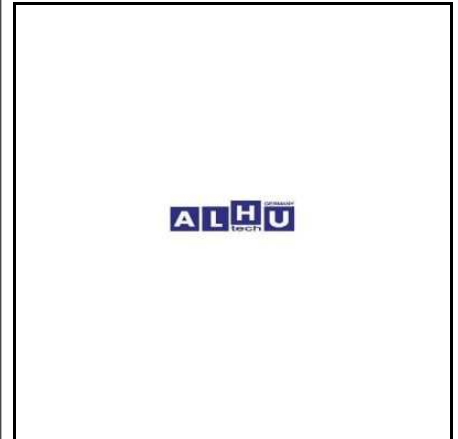

**11 240 013 ENGINE MOUNTING**

**Mercedes Benz**  
220 240 07 17



**11 240 014 ENGINE MOUNTING**

**Mercedes Benz**  
123 241 30 13



**11 240 015 ENGINE MOUNTING**

**Mercedes Benz**  
123 241 41 13



Achse / Axle

**11 240 016 ENGINE MOUNTING**

**Mercedes Benz**  
123 241 46 13



**11 240 017 ENGINE MOUNTING**

**Mercedes Benz**  
140 240 15 17

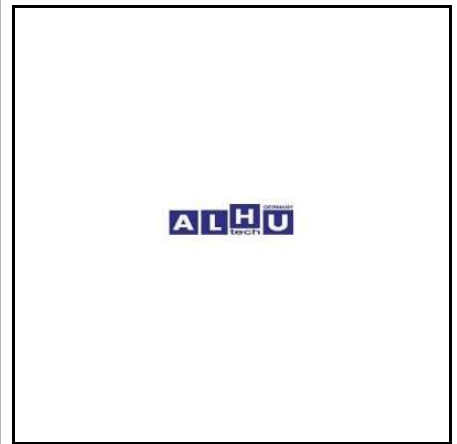

**11 240 018 ENGINE MOUNTING**

**Mercedes Benz**  
124 240 16 17

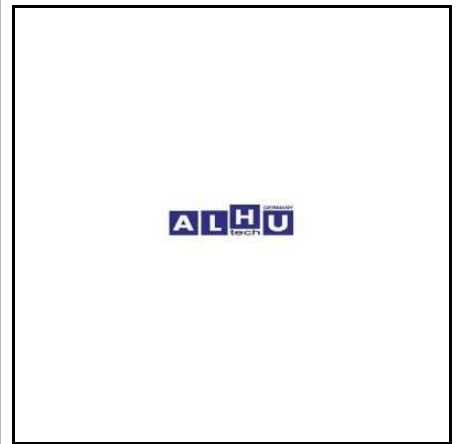

**11 240 019 ENGINE MOUNTING**

**Mercedes Benz**  
123 240 13 18

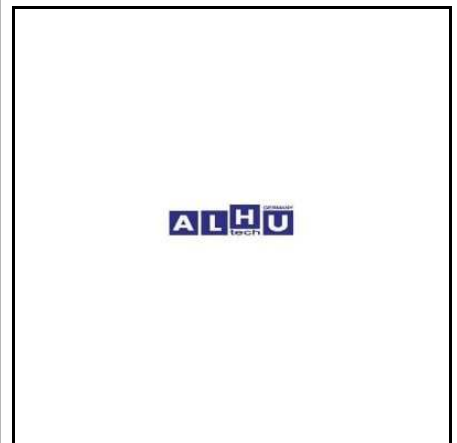



Achse / Axle

**11 240 020 ENGINE MOUNTING**

**Mercedes Benz**  
140 240 08 18

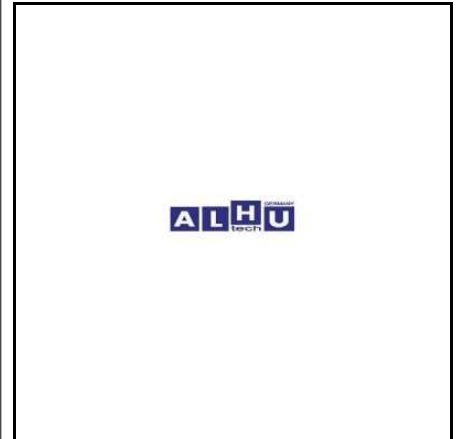

**11 240 021 ENGINE MOUNTING**

**Mercedes Benz**  
202 240 04 18



**11 240 022 ENGINE MOUNTING**

**Mercedes Benz**  
123 241 50 13



**11 240 023 ENGINE MOUNTING**

**Mercedes Benz**  
123 241 52 13



Achse / Axle

**11 240 024 ENGINE MOUNTING**

**Mercedes Benz**  
201 241 16 13



**11 240 025 ENGINE MOUNTING**

**Mercedes Benz**  
201 241 17 13



**11 240 026 ENGINE MOUNTING**

**Mercedes Benz**  
116 240 04 18

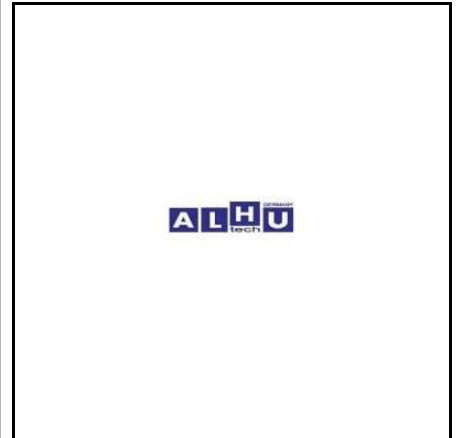

**11 240 027 ENGINE MOUNTING**

**Mercedes Benz**  
123 240 22 18

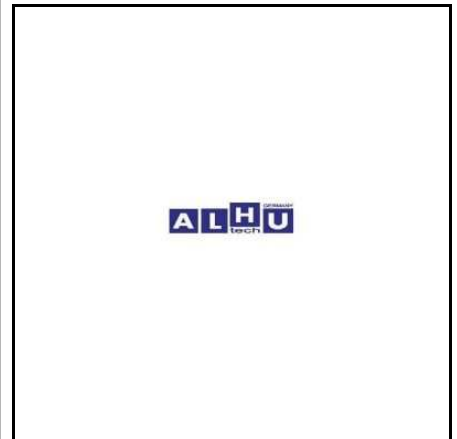

Achse / Axle

**11 240 028 ENGINE MOUNTING**

**Mercedes Benz**  
220 240 02 18

**LMI**  
1800202



**11 240 029 ENGINE MOUNTING**

**Mercedes Benz**  
210 240 20 17



**15 240 018 ENGINE MOUNTING**

**Mercedes Benz**  
210 240 05 18



**11 000 004 FLEXIBLE DISC KIT**

**Mercedes Benz**  
123 411 00 15



Achse / Axle

**11 000 005 FLEXIBLE DISC KIT**

**Mercedes Benz**  
123 411 02 15



**11 000 020 FLEXIBLE DISC KIT**

**Mercedes Benz**  
124 411 04 15



**11 000 021 FLEXIBLE DISC KIT**

**Mercedes Benz**  
124 411 05 15



**11 000 022 FLEXIBLE DISC KIT**

**Mercedes Benz**  
124 411 06 15



Achse / Axle

**11 000 025 FLEXIBLE DISC KIT**

**Mercedes Benz**  
129 410 01 15

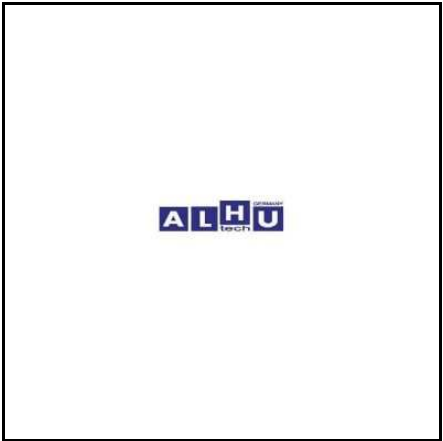

**11 000 036 FLEXIBLE DISC KIT**

**Mercedes Benz**  
201 410 10 15

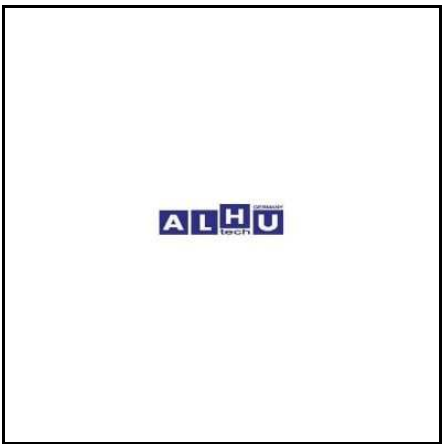

**11 410 015 FLEXIBLE DISC KIT**

**Mercedes Benz**  
124 410 00 15

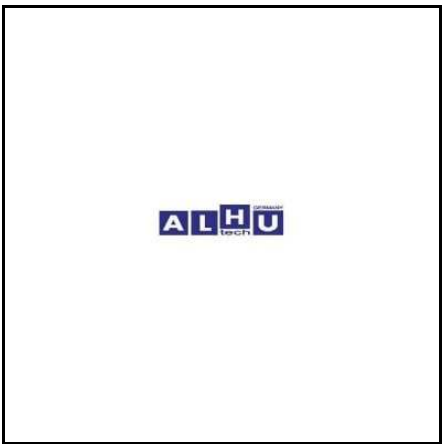

**11 410 016 FLEXIBLE DISC KIT**

**Mercedes Benz**  
123 410 00 15

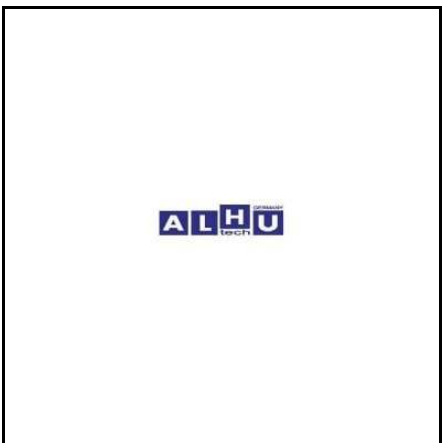

Achse / Axle

**11 410 017 FLEXIBLE DISC KIT**

**Mercedes Benz**  
126 410 01 15

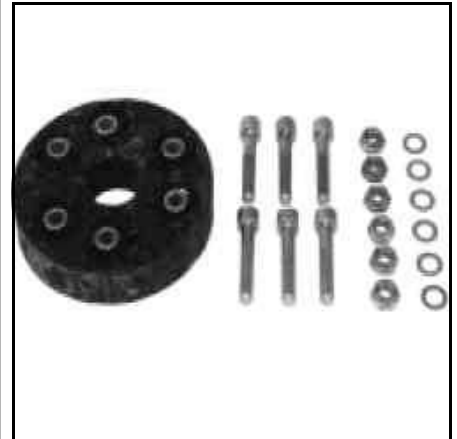

**11 410 018 FLEXIBLE DISC KIT**

**Mercedes Benz**  
201 410 07 15



**11 410 019 FLEXIBLE DISC KIT**

**Mercedes Benz**  
124 410 08 15



**11 410 020 FLEXIBLE DISC KIT**

**Mercedes Benz**  
202 410 10 15

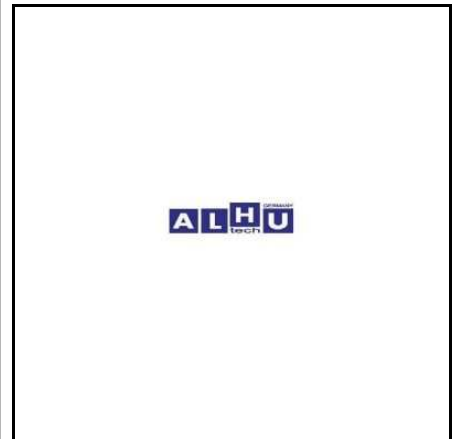

Achse / Axle

**11 410 021 FLEXIBLE DISC KIT**

**Mercedes Benz**  
202 410 11 15



**11 410 022 FLEXIBLE DISC KIT**

**Mercedes Benz**  
202 410 13 15



**11 410 023 FLEXIBLE DISC KIT**

**Mercedes Benz**  
210 410 08 15



**11 410 024 FLEXIBLE DISC KIT**

**Mercedes Benz**  
202 410 12 15



Achse / Axle

**11 410 025 FLEXIBLE DISC KIT**

**Mercedes Benz**  
202 411 03 15



**11 410 026 FLEXIBLE DISC KIT**

**Mercedes Benz**  
202 411 06 15



**11 410 027 FLEXIBLE DISC KIT**

**Mercedes Benz**  
210 410 12 15



**11 410 028 FLEXIBLE DISC KIT**

**Mercedes Benz**  
210 411 05 15





Achse / Axle

**11 410 029 FLEXIBLE DISC KIT**

**Mercedes Benz**  
129 410 02 15  
210 410 11 15

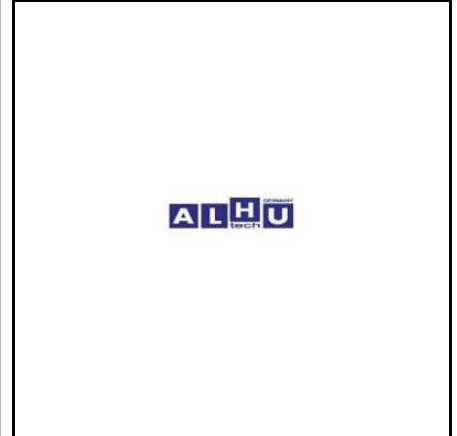

**11 410 415 FLEXIBLE DISC KIT**

**Mercedes Benz**  
126 410 04 15



**11 410 615 FLEXIBLE DISC KIT**

**Mercedes Benz**  
124 410 06 15

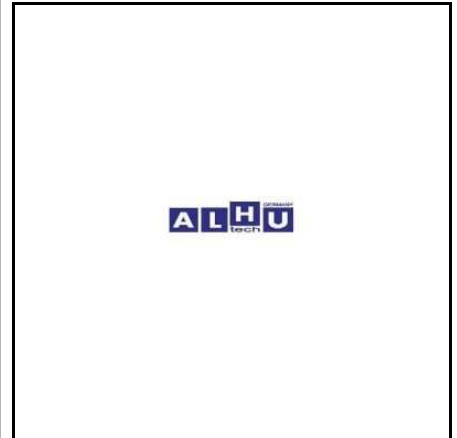

**13 330 107 LINK REPAIR KIT**

**Mercedes Benz**  
220 330 91 07



Achse / Axle

**11 000 035**    **PROPELLER SHAFT MOUNTING**

**Mercedes Benz**  
201 410 05 81



**11 410 081**    **PROPELLER SHAFT MOUNTING**  
without bearing

**Mercedes Benz**  
123 410 10 81



**11 410 481**    **PROPELLER SHAFT MOUNTING**  
without bearing

**Mercedes Benz**  
202 410 04 81



**11 410 581**    **PROPELLER SHAFT MOUNTING**  
without bearing

**Mercedes Benz**  
202 410 05 81



Achse / Axle

**11 410 681 PROPELLER SHAFT MOUNTING**  
without bearing

**Mercedes Benz**  
124 410 06 81



**11 410 781 PROPELLER SHAFT MOUNTING**  
without bearing

**Mercedes Benz**  
124 410 02 81  
124 410 07 81



**11 000 006 RADIATOR MOUNTING KIT**

W 123 W 126 W 124

**Mercedes Benz**  
123 500 00 12



**11 000 030 REP KIT REAR SUBFRAME**

**Mercedes Benz**  
140 350 87 08

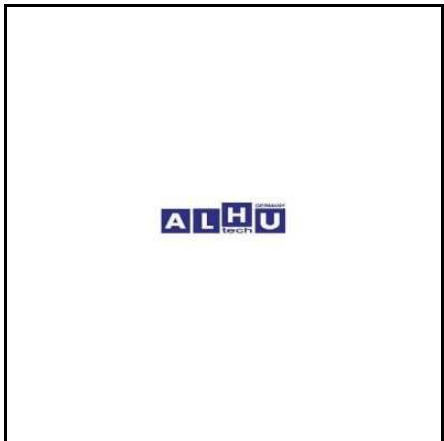

Achse / Axle

**11 000 043 REPAIR KIT, AXLE BODY**

**Mercedes Benz**  
202 350 34 08

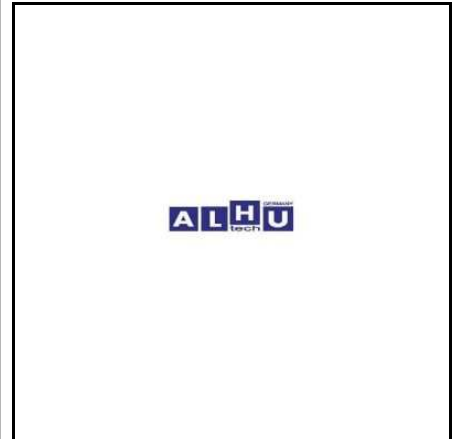

**11 352 170 REPAIR KIT, AXLE BODY**

**Mercedes Benz**  
210 350 58 08



**14 460 819 REPAIR KIT, IDLER ARM**

**Mercedes Benz**  
140 460 08 19



**13 460 819 REP. KIT, STEERING ARM**

**Mercedes Benz**  
126 460 08 19

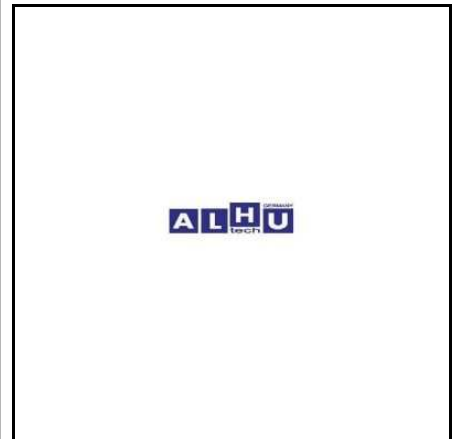

Achse / Axle

**14 460 050 REP. KIT, STEERING ARM**

**Mercedes Benz**  
201 460 00 50



**14 460 319 REP. KIT, STEERING ARM**

**Mercedes Benz**  
202 460 03 19



**13 320 189 ROD, TORSION BAR**

**Mercedes Benz**  
140 320 11 89



**13 320 289 ROD, TORSION BAR**

**Mercedes Benz**  
140 320 12 89



Achse / Axle

**11 000 001 RUBBER MOUNTING**

**Mercedes Benz**  
116 333 40 14



**11 000 003 RUBBER MOUNTING**

**Mercedes Benz**  
123 351 10 42



**11 000 009 RUBBER MOUNTING**

**Mercedes Benz**  
124 320 04 73



**11 000 012 RUBBER MOUNTING**

**Mercedes Benz**  
124 323 04 26



Achse / Axle

**11 000 013 RUBBER MOUNTING**

**Mercedes Benz**  
124 323 05 26



**11 000 014 RUBBER MOUNTING**

**Mercedes Benz**  
124 323 54 85



**11 000 015 RUBBER MOUNTING**

**Mercedes Benz**  
124 323 56 85



**11 000 016 RUBBER MOUNTING**

**Mercedes Benz**  
124 333 43 14



Achse / Axle

**11 000 017 RUBBER MOUNTING**

**Mercedes Benz**  
124 351 19 42



**11 000 018 RUBBER MOUNTING**

**Mercedes Benz**  
124 352 34 65



**11 000 019 RUBBER MOUNTING**

**Mercedes Benz**  
124 352 77 65



**11 000 023 RUBBER MOUNTING**

**Mercedes Benz**  
124 492 00 44





Achse / Axle

**11 000 024 RUBBER MOUNTING**

**Mercedes Benz**  
126 352 01 65



**11 000 029 RUBBER MOUNTING**

**Mercedes Benz**  
140 333 18 14



**11 000 032 RUBBER MOUNTING**

**Mercedes Benz**  
201 323 23 40



**11 000 033 RUBBER MOUNTING**

**Mercedes Benz**  
201 323 55 40



Achse / Axle

**11 000 034 RUBBER MOUNTING**

**Mercedes Benz**  
201 323 56 40



**11 000 037 RUBBER MOUNTING**

**Mercedes Benz**  
201 492 01 16



**11 000 042 RUBBER MOUNTING**

**Mercedes Benz**  
202 333 64 14



**11 000 045 RUBBER MOUNTING**

**Mercedes Benz**  
210 351 08 42



Achse / Axle

**11 000 047 RUBBER MOUNTING**

**Mercedes Benz**  
103 988 01 11



**11 000 048 RUBBER MOUNTING**

**Mercedes Benz**  
107 492 00 82



**11 352 167 STABILIZER BUSHING**

**Mercedes Benz**  
208 323 01 40



**11 000 010 STABILIZER KIT**

**Mercedes Benz**  
124 320 19 47



Achse / Axle

**11 000 011 STABILIZER KIT**

**Mercedes Benz**  
124 320 21 47



**11 000 031 STABILIZER KIT**

**Mercedes Benz**  
201 320 00 47



**10 000 017 STABILIZER LINK**

**Mercedes Benz**  
203 320 25 89



**13 320 689 STABILIZER LINK**

W 202 W 210

**Mercedes Benz**  
210 320 36 89

**LMI**  
2503902



Achse / Axle

**13 320 789 STABILIZER LINK**

W 202 W 210

**Mercedes Benz**  
210 320 37 89



**11 000 041 STABILIZER MOUNTING**

**Mercedes Benz**  
202 323 02 85



**11 000 046 STABILIZER MOUNTING**

**Mercedes Benz**  
602 321 02 50



**63 451 427 STEERING BELLOW**

 W 210

**Mercedes Benz**  
210 460 23 00

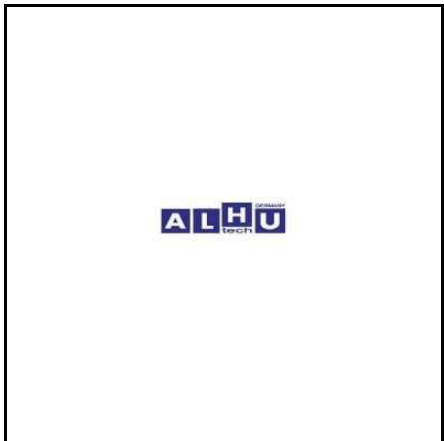

Achse / Axle

**13 320 444 STRUT BEARING**

**Mercedes Benz**  
124 320 14 44



**13 350 408 SUBFRAME MOUNT KIT**

**Mercedes Benz**  
124 350 64 08



**13 350 608 SUBFRAME MOUNT KIT**

**Mercedes Benz**  
124 350 86 08



**11 240 002 TRANSMISSION MOUNTING**

**Mercedes Benz**  
124 240 06 18



Achse / Axle

**13 330 051 WHEEL BEARING KIT**

short kit

**Mercedes Benz**  
126 330 00 51

**ALHU tech**  
13 981 005



**13 980 016 WHEEL BEARING KIT**

short kit

**Mercedes Benz**  
202 980 00 16



**13 980 516 WHEEL BEARING KIT**

short kit

**Mercedes Benz**  
140 980 05 16



**13 980 616 WHEEL BEARING KIT**

short kit

**Mercedes Benz**  
124 350 05 49  
124 980 05 16



Achse / Axle

**13 981 001 WHEEL BEARING KIT**  
 full kit

**Mercedes Benz**  
 116 330 00 51  
 611 330 07 25



**13 981 002 WHEEL BEARING KIT**  
 full kit

**Mercedes Benz**  
 123 350 00 68



**13 981 003 WHEEL BEARING KIT**  
 full kit

**Mercedes Benz**  
 124 350 05 49  
 124 980 05 16



**13 981 004 WHEEL BEARING KIT**  
 full kit

**Mercedes Benz**  
 124 350 06 49  
 124 980 04 16





Achse / Axle

**13 981 006 WHEEL BEARING KIT**  
full kit

**Mercedes Benz**  
140 330 00 51  
140 330 02 51



**13 981 007 WHEEL BEARING KIT**  
full kit

**Mercedes Benz**  
140 980 04 16



**13 981 008 WHEEL BEARING KIT**  
full kit

**Mercedes Benz**  
140 980 05 16



**13 981 009 WHEEL BEARING KIT**  
full kit

**Mercedes Benz**  
140 980 06 16  
140 980 07 16



Achse / Axle

**13 981 010 WHEEL BEARING KIT**  
full kit

**Mercedes Benz**  
163 330 00 51



**13 981 011 WHEEL BEARING KIT**  
full kit

**Mercedes Benz**  
201 330 00 51



**13 981 012 WHEEL BEARING KIT**  
full kit

**Mercedes Benz**  
201 330 01 51



**13 981 013 WHEEL BEARING KIT**  
full kit

**Mercedes Benz**  
201 330 02 51



Achse / Axle

**13 981 014 WHEEL BEARING KIT**  
full kit

**Mercedes Benz**  
202 980 00 16



**13 981 015 WHEEL BEARING KIT**  
full kit

**Mercedes Benz**  
202 980 01 16

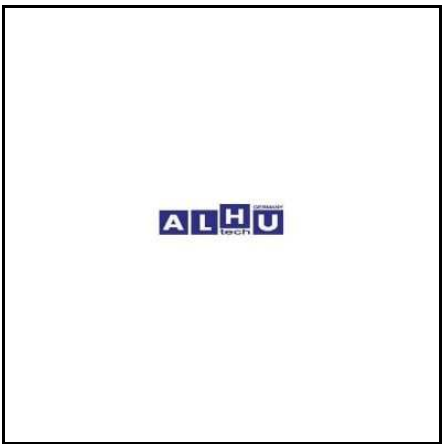

**13 981 016 WHEEL BEARING KIT**  
full kit

**Mercedes Benz**  
203 330 00 51

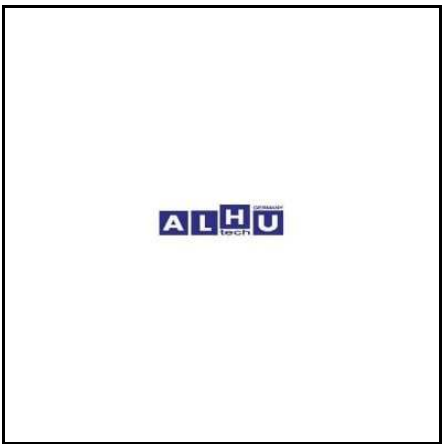

**13 981 017 WHEEL BEARING KIT**  
full kit

**Mercedes Benz**  
210 330 00 51

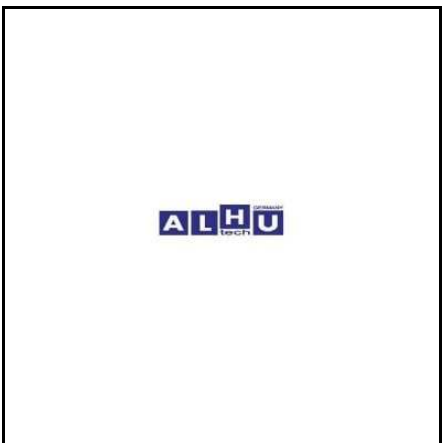

Achse / Axle

**13 981 018 WHEEL BEARING KIT**  
full kit

**Mercedes Benz**  
220 330 07 25



**13 981 019 WHEEL BEARING KIT**  
full kit

**Mercedes Benz**  
220 980 00 16



**13 981 020 WHEEL BEARING KIT**  
full kit

**Mercedes Benz**  
220 980 01 16



**13 981 021 WHEEL BEARING KIT**  
full kit

**Mercedes Benz**  
601 350 00 68  
601 350 01 68  
601 350 02 68



Achse / Axle

13 981 022	WHEEL BEARING KIT
	full kit
<b>Mercedes Benz</b>	
902 350 00 68	
<b>VW</b>	
2D0 501 319	



13 981 023	WHEEL HUB
<b>Mercedes Benz</b>	
230 330 03 25	



Bremse / Brake

**11 540 008 ABS SENSOR**

W210

**Mercedes Benz**  
210 540 90 08



**11 540 108 ABS SENSOR**

W210

**Mercedes Benz**  
210 540 91 08



**11 540 717 ABS SENSOR**

W210

**Mercedes Benz**  
210 540 07 17

**Bosch**  
0 265 006 194



**13 752 228 ABS SENSOR**

**Mercedes Benz**  
002 153 92 28

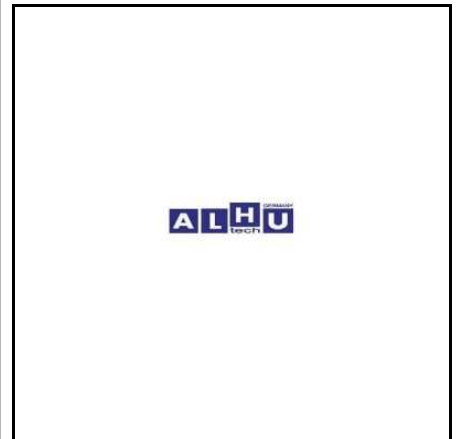

Bremse / Brake

**13 752 428    ABS SENSOR**

**Mercedes Benz**  
003 153 74 28

**Bosch**  
0 281 002 123



**13 753 008    ABS SENSOR**

W204

**Mercedes Benz**  
204 540 01 17

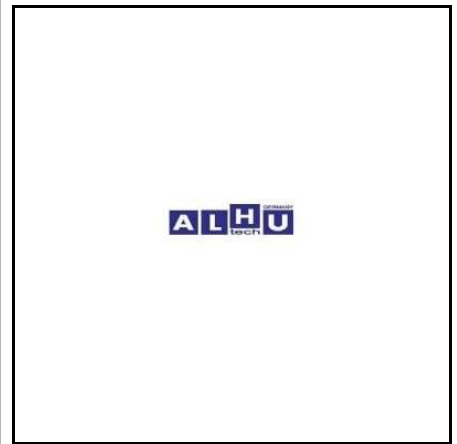

**13 753 009    ABS SENSOR**

**Mercedes Benz**  
168 540 03 17

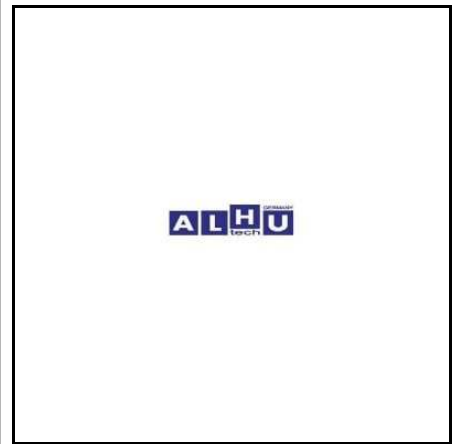

**13 756 017    ABS SENSOR**

**Mercedes Benz**  
168 540 01 17

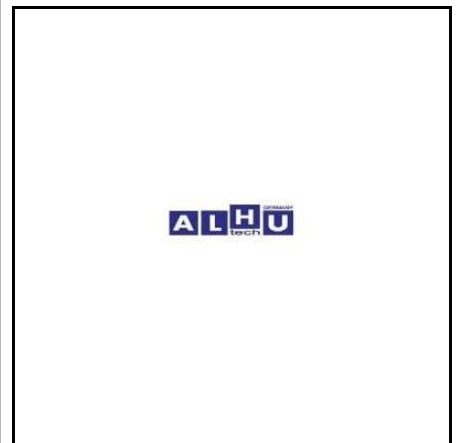

Bremse / Brake

**13 756 117    ABS SENSOR**

**Mercedes Benz**  
220 540 01 17



**13 756 217    ABS SENSOR**

W210

**Mercedes Benz**  
210 540 06 17

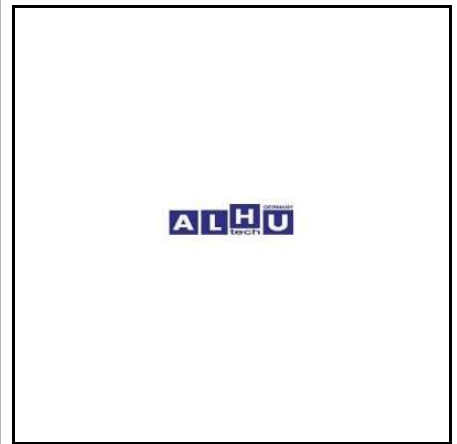

**13 756 317    ABS SENSOR**

W203

**Mercedes Benz**  
203 540 13 17



**13 756 318    ABS SENSOR**

W203

**Mercedes Benz**  
203 540 14 17





Bremse / Brake

**13 756 319 ABS SENSOR**

W211

**Mercedes Benz**  
211 540 23 17



**13 756 320 ABS SENSOR**

W211

**Mercedes Benz**  
211 540 24 17



**13 756 417 ABS SENSOR**

**Mercedes Benz**  
220 540 04 17



**13 756 517 ABS SENSOR**

**Mercedes Benz**  
220 540 05 17





Bremse / Brake

**13 927 002    ABS SENSOR**  
rear  
SPRINTER

**Mercedes Benz**  
901 542 11 17

**VW**  
2D0 927 807 A

**Bosch**  
0 265 004 010



**10 000 003    BRAKE HOSE**

**Mercedes Benz**  
123 428 02 35



**10 000 004    BRAKE HOSE**

**Mercedes Benz**  
631 428 00 35



**10 000 005    BRAKE HOSE**

**Mercedes Benz**  
210 428 00 35



**Bremse / Brake**

**10 000 006 BRAKE HOSE**

**Mercedes Benz**  
123 428 05 35



**10 000 007 BRAKE HOSE**

**Mercedes Benz**  
140 420 00 48



**10 000 008 BRAKE HOSE**

**Mercedes Benz**  
129 428 10 35



**10 000 009 BRAKE HOSE**

**Mercedes Benz**  
001 428 95 35



Bremse / Brake

**13 343 028 BRAKE WEAR INDICATOR**

**Mercedes Benz**  
000 420 04 02

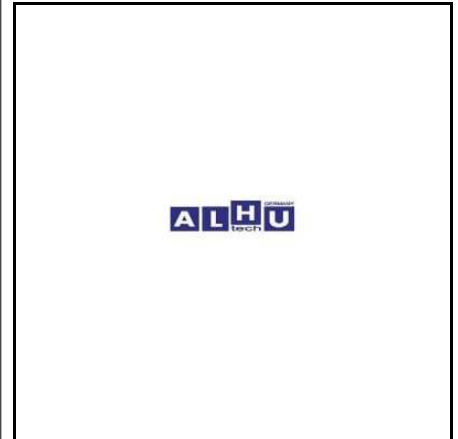

**13 540 001 BRAKE WEAR INDICATOR**

**Mercedes Benz**  
670 540 00 17

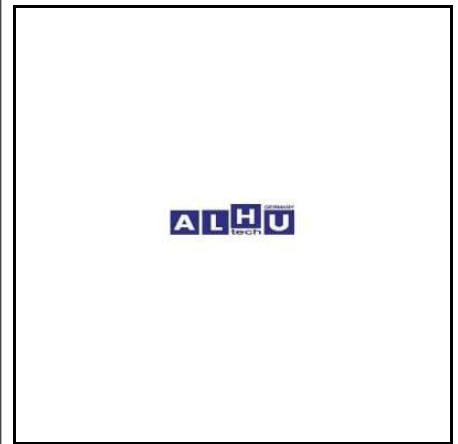

**13 540 021 BRAKE WEAR INDICATOR**

**Mercedes Benz**  
901 540 02 17  
901 540 03 17

**VW**  
2D0 919 351 A



**13 540 031 BRAKE WEAR INDICATOR**

W201

**Mercedes Benz**  
201 540 03 17



Bremse / Brake

**13 540 041 BRAKE WEAR INDICATOR**

**Mercedes Benz**  
669 540 04 17

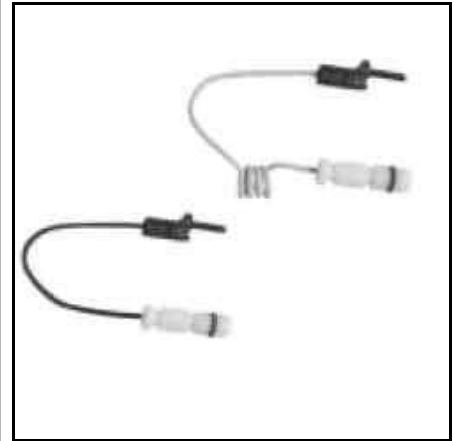

**13 540 061 BRAKE WEAR INDICATOR**

**Mercedes Benz**  
460 540 06 17

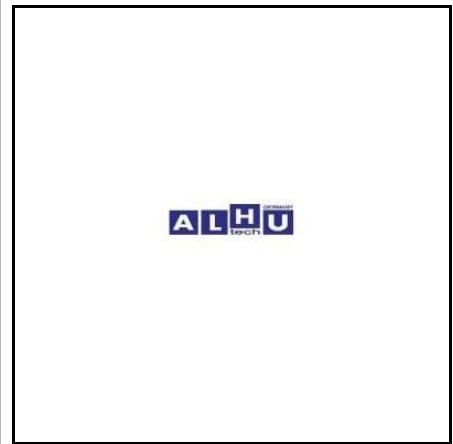

**13 540 062 BRAKE WEAR INDICATOR**

**Mercedes Benz**  
601 540 06 17

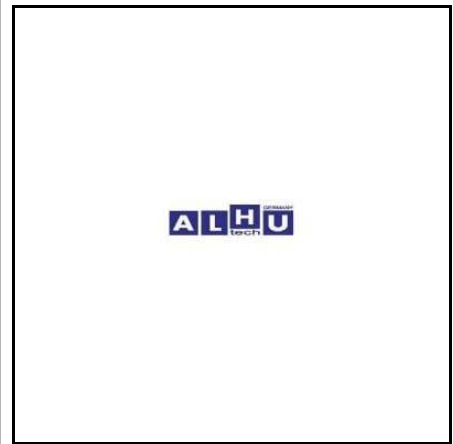

**13 540 071 BRAKE WEAR INDICATOR**

W211

**Mercedes Benz**  
211 540 07 17

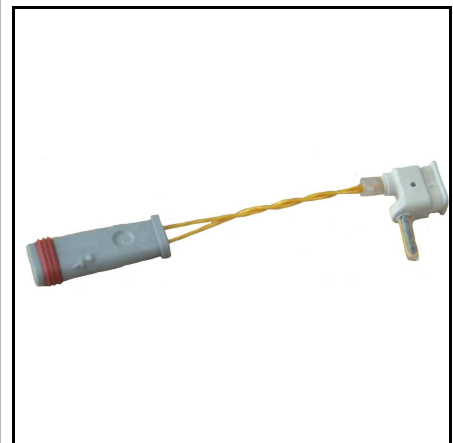

Bremse / Brake

**13 540 072 BRAKE WEAR INDICATOR**

**Mercedes Benz**  
677 540 07 17



**13 540 073 BRAKE WEAR INDICATOR**

**Mercedes Benz**  
669 540 07 17

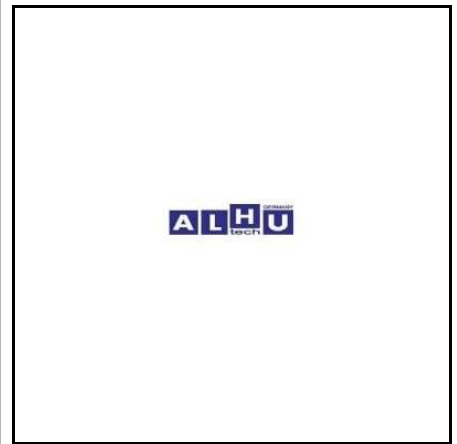

**13 540 081 BRAKE WEAR INDICATOR**

**Mercedes Benz**  
669 540 08 17

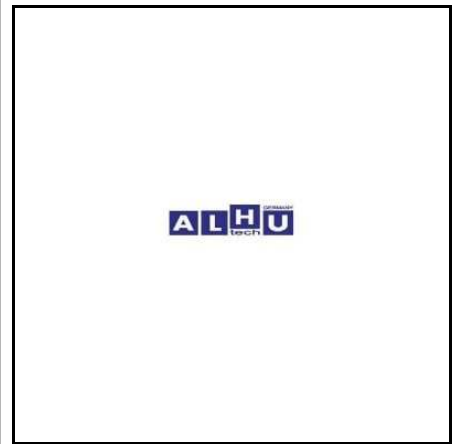

**13 540 111 BRAKE WEAR INDICATOR**

W210

**Mercedes Benz**  
210 540 11 17



Bremse / Brake

**13 540 117 BRAKE WEAR INDICATOR**

**Mercedes Benz**

901 540 00 17  
901 540 01 17

**VW**

2D0 919 351



**13 540 121 BRAKE WEAR INDICATOR**

W140

**Mercedes Benz**

000 540 02 17  
123 540 00 17  
126 540 20 17



**13 540 131 BRAKE WEAR INDICATOR**

**Mercedes Benz**

601 540 13 17

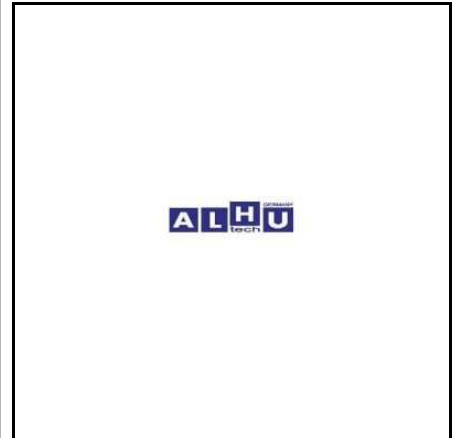

**13 540 151 BRAKE WEAR INDICATOR**

W163

**Mercedes Benz**

163 540 15 17  
163 540 17 17





Bremse / Brake

**13 540 317 BRAKE WEAR INDICATOR**

W163

**Mercedes Benz**  
163 540 13 17

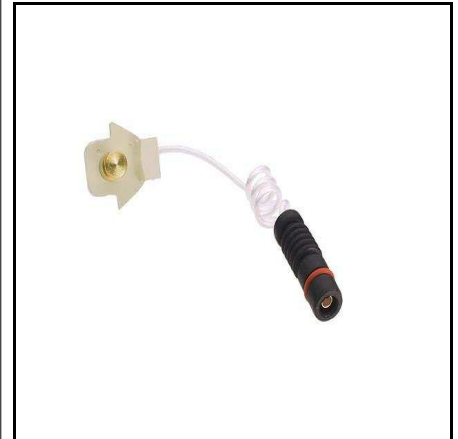

**13 540 320 BRAKE WEAR INDICATOR**

**Mercedes Benz**  
906 540 13 17



**13 540 417 BRAKE WEAR INDICATOR**

W163

**Mercedes Benz**  
163 540 14 17



**13 540 517 BRAKE WEAR INDICATOR**

W220

**Mercedes Benz**  
164 540 10 17  
220 540 15 17  
639 540 15 17



Bremse / Brake

**13 540 617 BRAKE WEAR INDICATOR**

W211

**Mercedes Benz**  
 220 540 06 17  
 220 540 07 17



**13 540 717 BRAKE WEAR INDICATOR**

W202

**Mercedes Benz**  
 202 540 07 17



**13 540 835 BRAKE WEAR INDICATOR**

**Mercedes Benz**  
 639 540 14 17



**13 540 838 BRAKE WEAR INDICATOR**

**Mercedes Benz**  
 906 540 14 17  
 906 540 15 17

**VW**  
 2E0 906 206 C



Bremse / Brake

**13 540 917 BRAKE WEAR INDICATOR**

**Mercedes Benz**  
669 540 09 17



**13 542 017 BRAKE WEAR INDICATOR**

**Mercedes Benz**  
435 542 00 17

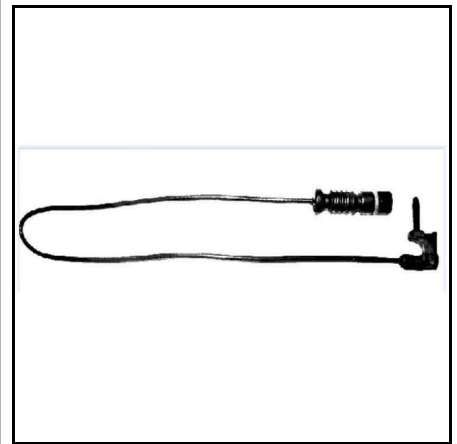

**14 752 000 BRAKE WEAR INDICATOR**

W221

**Mercedes Benz**  
171 540 06 17

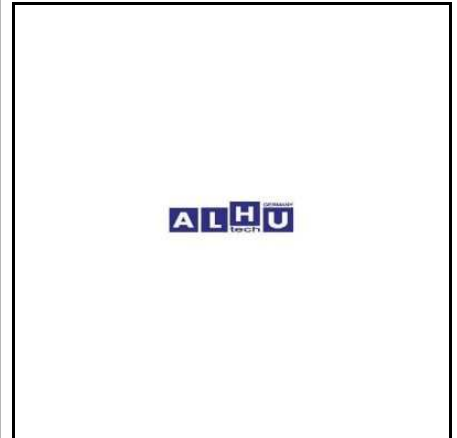

**10 000 002 FUEL PUMP**

**Bosch**  
0 580 254 982

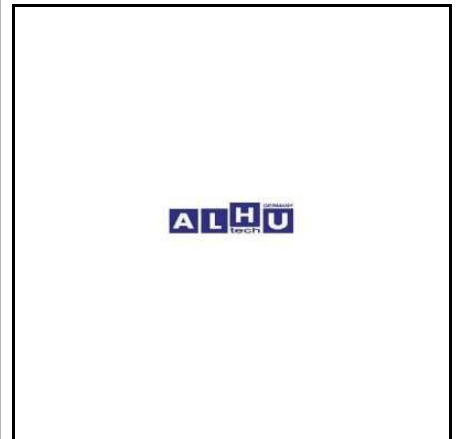

**Bremse / Brake**

<b>13 752 628</b>	<b>RPM SENSOR</b>
crankshaft	
<b>Mercedes Benz</b>	
003 153 96 28	



<b>13 752 728</b>	<b>RPM SENSOR</b>
crankshaft	
<b>Mercedes Benz</b>	
003 153 27 28	
003 153 28 28	



<b>13 752 528</b>	<b>SENSOR, CAMSHAFT</b>
<b>Mercedes Benz</b>	
002 153 95 28	



<b>13 752 928</b>	<b>SENSOR, CAMSHAFT</b>
<b>Mercedes Benz</b>	
004 153 69 28	



**Bremse / Brake**

**13 756 817    SENSOR, WHEEL SPEED**

**Mercedes Benz**  
129 540 08 17



Elektrik / Electric

**11 158 001    DISTRIBUTOR CAP**

<b>Mercedes Benz</b> 000 158 43 02	<b>Bosch</b> 1 235 522 327
<b>BERU</b> VK 310 S	



**11 158 002    DISTRIBUTOR CAP**

<b>Mercedes Benz</b> 000 158 49 02	<b>Bosch</b> 1 235 522 380
<b>BERU</b> VK 191 S	



**11 158 003    DISTRIBUTOR CAP**

<b>Mercedes Benz</b> 103 158 00 02	<b>Bosch</b> 1 235 522 384
<b>BERU</b> VK 384	



**11 158 004    DISTRIBUTOR CAP**

<b>Mercedes Benz</b> 000 158 44 02	
<b>BERU</b> VK 311	

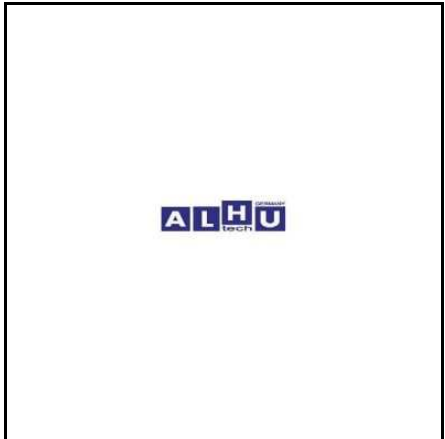

Elektrik / Electric

**11 158 005    DISTRIBUTOR CAP**

**Mercedes Benz**  
000 158 27 02

**BERU**  
VK 284 P



**11 158 006    DISTRIBUTOR ROTOR**

**Mercedes Benz**  
103 158 03 31

**Bosch**  
1 234 332 417

**BERU**  
EVL 145

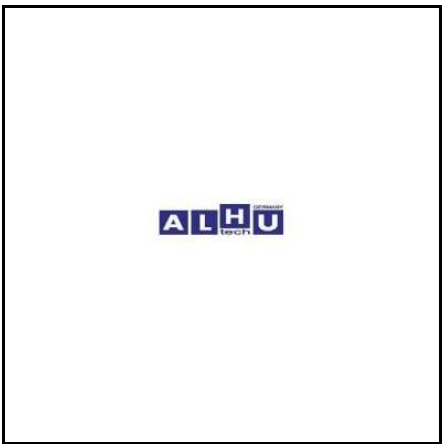

**11 158 007    DISTRIBUTOR ROTOR**

**Mercedes Benz**  
104 158 02 31

**Bosch**  
1 234 332 427

**BERU**  
EVL 196

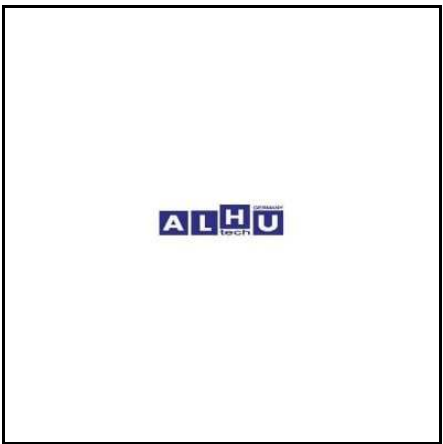

**11 158 008    DISTRIBUTOR ROTOR**

**Mercedes Benz**  
000 158 36 31

**BERU**  
EVL 114

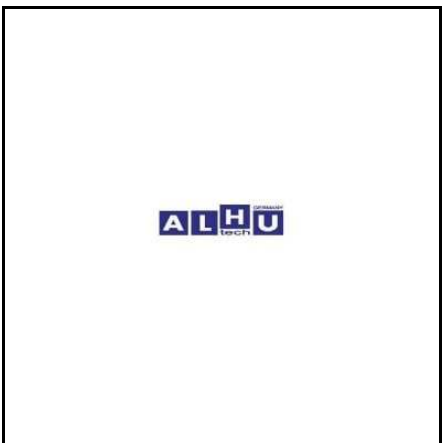

Elektrik / Electric

**11 158 009    DISTRIBUTOR ROTOR**

**Mercedes Benz**  
000 158 26 31

**Bosch**  
1 234 332 204

**BERU**  
EVL 069



**15 545 832    IGNITION MODULE**

**Mercedes Benz**  
001 545 86 32  
002 545 18 32

**BERU**  
ZM 004



**11 311 213    REGULATOR**

**Bosch**  
1 197 311 213



**63 451 423    RESISTOR, black**

 W 124 W126 W201

**Mercedes Benz**  
000 158 25 45

**BERU**  
WZ 02-2





Elektrik / Electric

**11 311 023 VOLTAGE REGULATOR**

**Mercedes Benz**  
002 154 72 06

**Bosch**  
1 197 311 022  
1 197 311 023

**BERU**  
GER 005

**Volvo**  
1324617

weitere/another



**11 311 090 VOLTAGE REGULATOR**

**Mercedes Benz**  
002 154 58 06  
002 154 85 06

**VW**  
00A 903 803

**Bosch**  
1 197 311 090

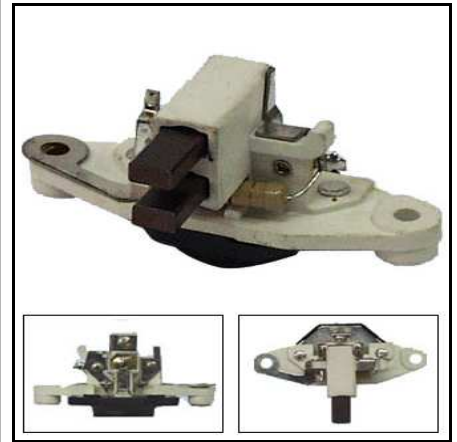

Getriebe / Gear

**11 250 115 CLUTCH RELEASE BEARING**

W 168

**Mercedes Benz**  
002 250 18 15

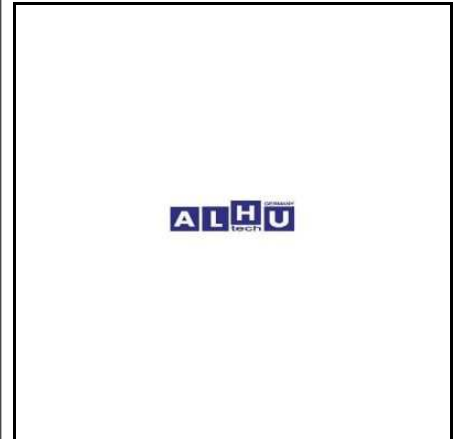

**11 254 808 CLUTCH RELEASE BEARING**

VITO

**Mercedes Benz**  
000 254 18 08

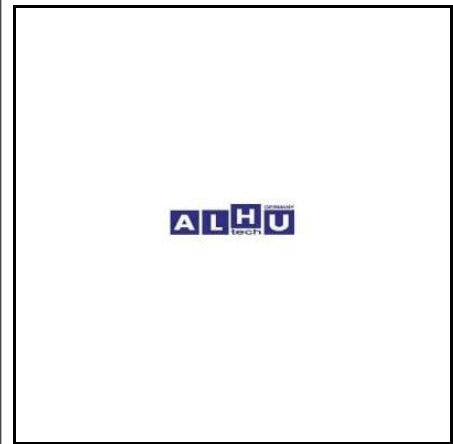

**12 140 095 TRANSMISSION FILTER**

without gasket

**Mercedes Benz**  
140 277 00 95

**ALHU tech**  
12 277 095



**12 126 295 TRANSMISSION FILTER**

without gasket

**Mercedes Benz**  
126 277 02 95

**Mann + Hummel**  
H2014



Getriebe / Gear

**12 129 195 TRANSMISSION FILTER**  
without gasket

**Mercedes Benz**  
129 277 01 95

**Mann + Hummel**  
H1914/2



**15 277 195 TRANSMISSION FILTER**  
without gasket

**Mercedes Benz**  
109 270 02 98

**Mann + Hummel**  
H 199/1

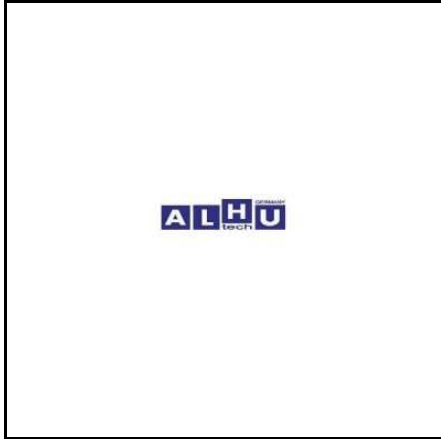

**12 271 080 TRANSMISSION FILTER GASKET**

W 140

**Mercedes Benz**  
140 271 00 80

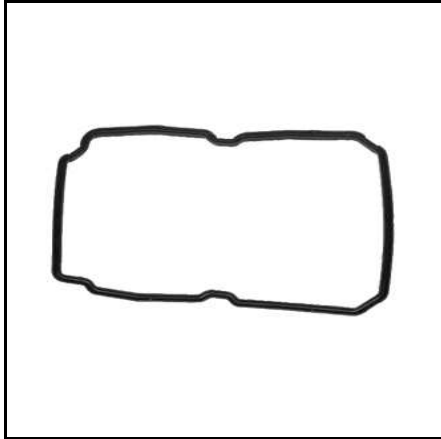

**12 271 180 TRANSMISSION FILTER GASKET**

W 126

**Mercedes Benz**  
126 271 10 80  
126 271 11 80

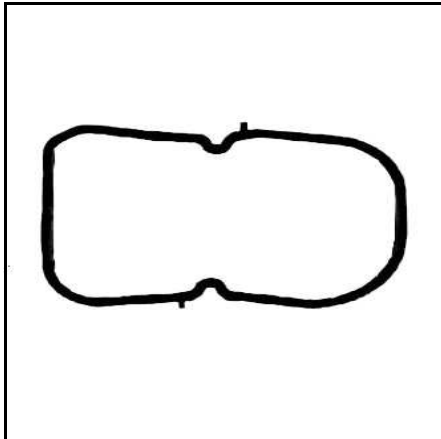

Getriebe / Gear

**12 271 280 TRANSMISSION FILTER GASKET**

W 203 W 204 W 211

**Mercedes Benz**  
220 271 03 80

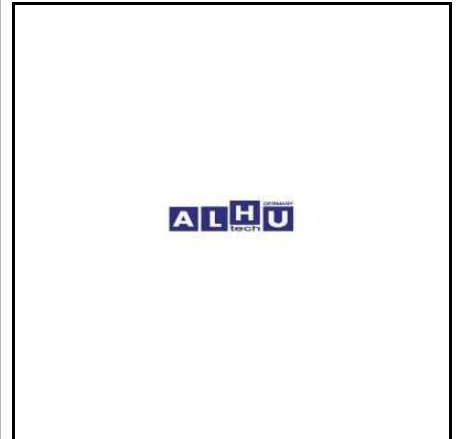

**12 271 380 TRANSMISSION FILTER GASKET**

**Mercedes Benz**  
201 271 03 80



**12 586 195 TRANSMISSION FILTER KIT**

**Mercedes Benz**  
129 277 01 95

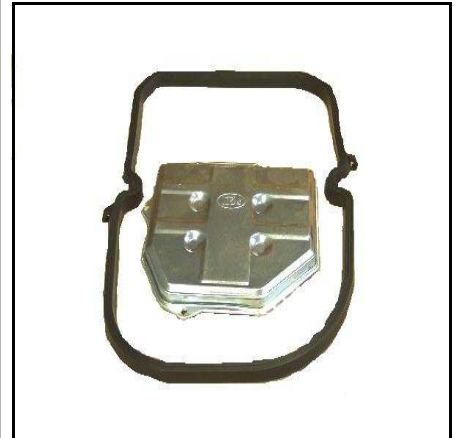

**12 586 295 TRANSMISSION FILTER KIT**

**Mercedes Benz**  
126 277 02 95



Getriebe / Gear

15 270 001 TRANSMISSION GASKET KIT

**Mercedes Benz**  
201 270 48 01

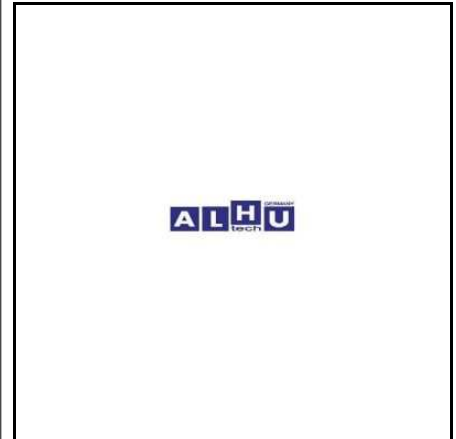

22 270 500 TRANSMISSION GASKET KIT



**Mercedes Benz**  
140 270 65 00

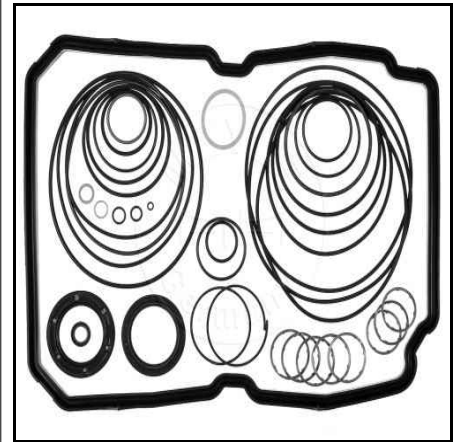

632074 TRANSMISSION GASKET KIT

**Mercedes Benz**  
126 270 61 00

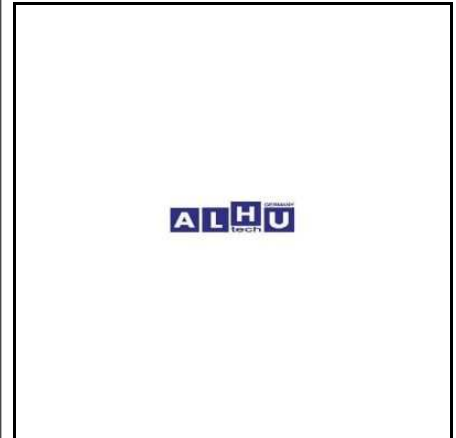

Kabine / Cabin

**11 830 208 BLOWER MOTOR**

W140

**Mercedes Benz**  
140 830 12 08



**18 820 000 BLOWER MOTOR**

**Mercedes Benz**  
163 820 21 42



**18 820 001 BLOWER MOTOR**

W202

**Mercedes Benz**  
202 820 92 42



**18 820 342 BLOWER MOTOR**

W202

**Mercedes Benz**  
202 820 93 42

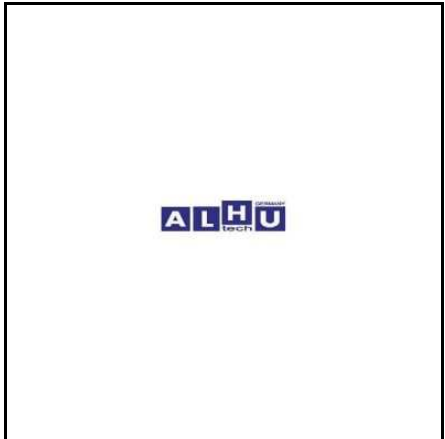

Kabine / Cabin

18 820 442 BLOWER MOTOR	
	W210
<p><b>Mercedes Benz</b> 210 820 24 42</p>	



18 820 608 BLOWER MOTOR	
	W124
<p><b>Mercedes Benz</b> 124 820 06 08</p>	

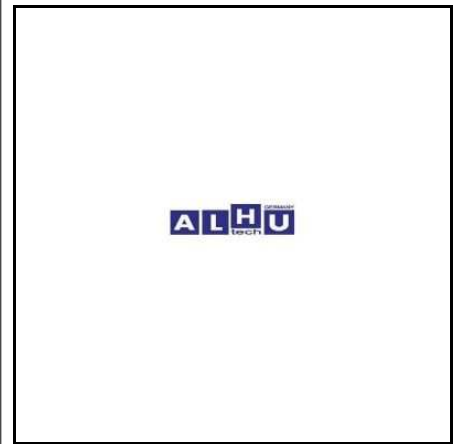

18 820 943 BLOWER MOTOR	
	W201
<p><b>Mercedes Benz</b> 201 820 45 42</p>	



18 830 008 BLOWER MOTOR	
	W124
<p><b>Mercedes Benz</b> 000 830 82 08</p>	



Kabine / Cabin

**18 830 208 BLOWER MOTOR**

W638

**Mercedes Benz**  
002 830 15 08



**18 830 408 BLOWER MOTOR**

W124

**Mercedes Benz**  
000 830 79 08

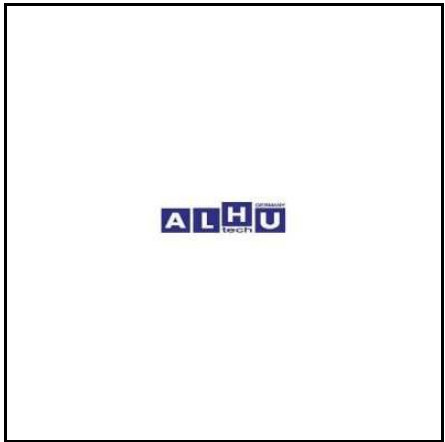

**18 830 608 BLOWER MOTOR**

**Mercedes Benz**  
002 830 16 08



**18 835 285 BLOWER MOTOR**

**Mercedes Benz**  
000 835 22 85





Kabine / Cabin

**18 835 385 BLOWER MOTOR**

**Mercedes Benz**  
000 835 23 85



**18 680 025 BONNET INSULATION**

**Mercedes Benz**  
202 680 00 25



**58 290 002 CLIP**

**Mercedes Benz**  
001 988 60 81



**58 290 003 CLIP**

**Mercedes Benz**  
001 988 51 81



Kabine / Cabin

**58 290 004 CLIP**

**Mercedes Benz**  
001 988 49 81

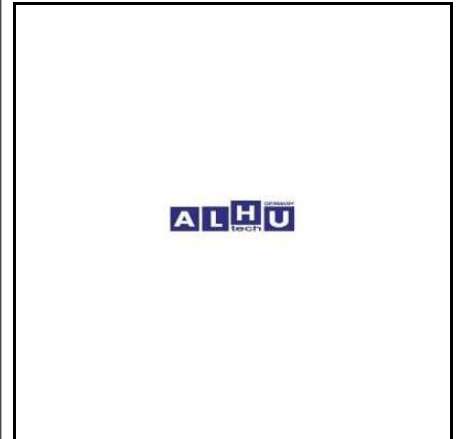

**58 290 005 CLIP**

**Mercedes Benz**  
000 990 44 92

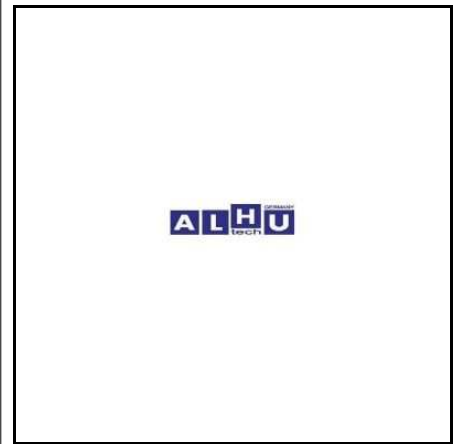

**11 880 001 CLIP, BUMPER**

**Mercedes Benz**  
201 880 01 14



**11 880 006 CLIP, BUMPER**

**Mercedes Benz**  
001 997 95 86



Kabine / Cabin

**11 880 007 CLIP, BUMPER**

**Mercedes Benz**  
202 997 01 86



**18 760 361 DOOR HANDLE**

SPRINTER

**Mercedes Benz**  
901 760 13 61

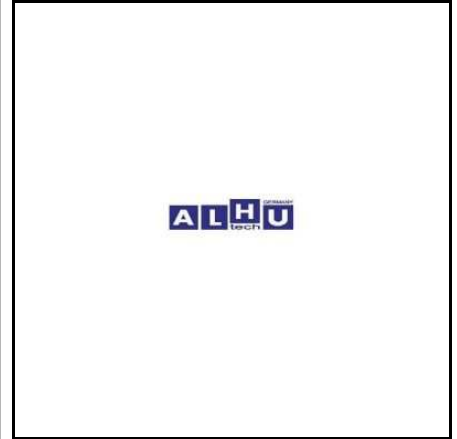

**18 720 116 DOOR STOP**

W140 W202 W210

**Mercedes Benz**  
210 720 01 16

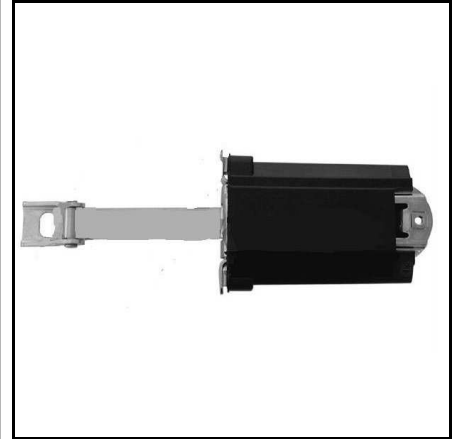

**18 720 516 DOOR STOP**

W123 W124 W126

**Mercedes Benz**  
126 720 05 16



Kabine / Cabin

**18 720 616 DOOR STOP**

**Mercedes Benz**  
140 720 06 16

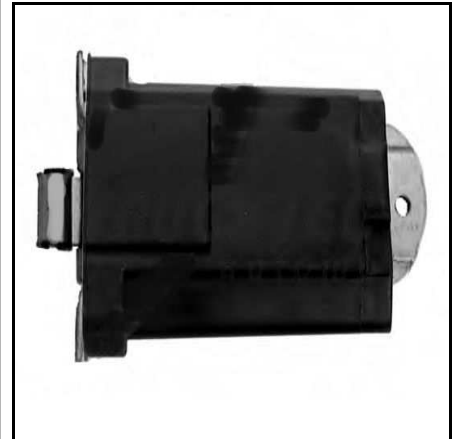

**11 880 004 HANDLE, BONNET RELEASE**

**Mercedes Benz**  
203 887 01 27  
203 887 04 27



**11 880 005 HANDLE, BONNET RELEASE**

**Mercedes Benz**  
220 887 02 27



**18 880 220 HANDLE, BONNET RELEASE**

**Mercedes Benz**  
124 880 02 20



Kabine / Cabin

**28 760 459 HANDLE, DOOR AND SLIDING DOOR**

VITO

**Mercedes Benz**  
901 760 04 59



**16 880 020 HANDLE, HOOD RELEASE CABLE**

**Mercedes Benz**  
126 880 00 20



**18 835 001 HEAT EXCHANGER**

**Mercedes Benz**  
002 835 30 01

**Behr/Hella**  
8FH 351 311-511

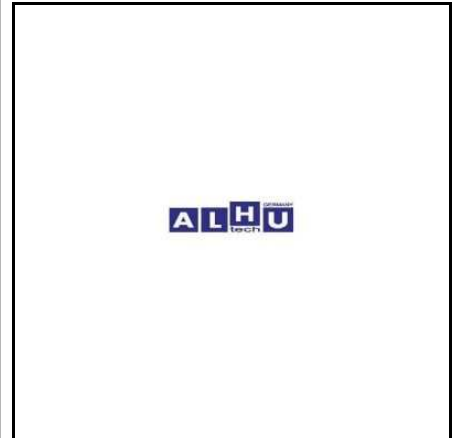

**18 835 101 HEAT EXCHANGER**

W 124 W 126

**Mercedes Benz**  
002 835 63 01

**Behr/Hella**  
8FH 351 311-691

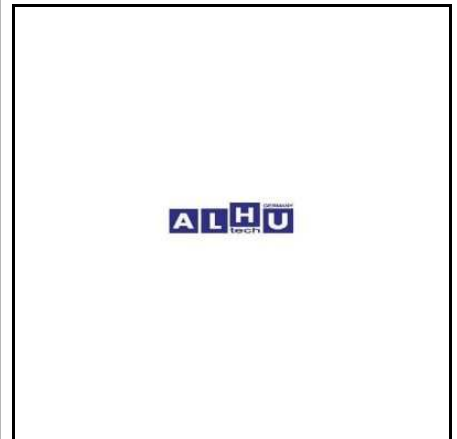

Kabine / Cabin

**18 835 201 HEAT EXCHANGER**

W 126

**Mercedes Benz**  
002 835 52 01



**18 835 301 HEAT EXCHANGER**

**Mercedes Benz**  
001 835 83 01

**Behr/Hella**  
8FH 351 312-271



**18 835 401 HEAT EXCHANGER**

**Mercedes Benz**  
002 835 24 01

**Behr/Hella**  
8FH 351 312-431



**18 835 701 HEAT EXCHANGER**

W 201

**Mercedes Benz**  
002 835 54 01

**Behr/Hella**  
8FH 351 311-591



Kabine / Cabin

**18 680 026 HOOD PAD**

**Mercedes Benz**  
124 682 00 26



**18 680 126 HOOD PAD**

**Mercedes Benz**  
210 682 02 26



**18 680 425 HOOD PAD WITH ALUMINIUM**

**Mercedes Benz**  
124 680 14 25



**14 462 327 LOCK CYLINDER**

SPRINTER

**Mercedes Benz**  
901 462 03 79



Kabine / Cabin

**11 880 008 NUT, BUMPER**

**Mercedes Benz**  
201 990 00 50



**18 719 046 WINDOW LIFTER**  
without motor, front, left

**Mercedes Benz**  
638 720 00 46



**18 719 146 WINDOW LIFTER**  
without motor, front, right

**Mercedes Benz**  
638 720 01 46



**18 719 246 WINDOW LIFTER**  
with motor, front, left

**Mercedes Benz**  
638 720 00 46





Kabine / Cabin

**18 719 346**    **WINDOW LIFTER**  
with motor, front, right

**Mercedes Benz**  
638 720 01 46



**18 719 646**    **WINDOW LIFTER**  
front, left

**Mercedes Benz**  
124 720 17 46



**18 719 746**    **WINDOW LIFTER**  
front, left

**Mercedes Benz**  
124 720 18 46



**18 720 046**    **WINDOW LIFTER**  
without motor, front, left

W210

**Mercedes Benz**  
210 720 11 46



Kabine / Cabin

**18 720 146 WINDOW LIFTER**  
FRONT - RIGHT W/O MOTOR  
W210

**Mercedes Benz**  
210 720 12 46

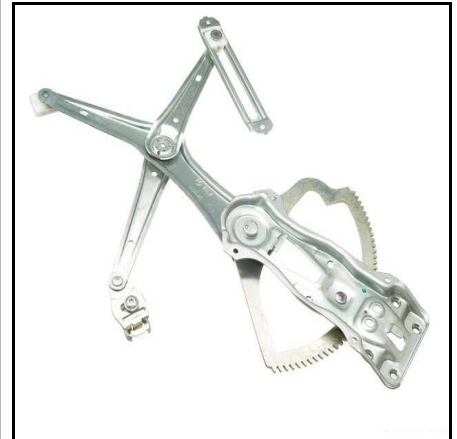

**18 720 346 WINDOW LIFTER**  
front, left

**Mercedes Benz**  
124 720 03 46



**18 720 446 WINDOW LIFTER**  
front, right

**Mercedes Benz**  
124 720 04 46



**18 720 546 WINDOW LIFTER**  
without motor, front, left

**Mercedes Benz**  
220 720 03 46



Kabine / Cabin

**18 720 646 WINDOW LIFTER**  
front, right, without motor

**Mercedes Benz**  
220 720 04 46



**18 720 746 WINDOW LIFTER**  
front, left

**Mercedes Benz**  
220 720 25 46



**18 720 846 WINDOW LIFTER**  
front, right

**Mercedes Benz**  
220 720 26 46



**18 721 446 WINDOW LIFTER**

**Mercedes Benz**  
140 720 29 46



Kabine / Cabin

**18 721 546 WINDOW LIFTER**

**Mercedes Benz**  
140 720 30 46



**18 721 846 WINDOW LIFTER**  
without motor, front, left

**Mercedes Benz**  
163 720 11 46



**18 721 946 WINDOW LIFTER**  
without motor, front, right

**Mercedes Benz**  
163 720 12 46



**18 724 346 WINDOW LIFTER**

**Mercedes Benz**  
126 720 13 46

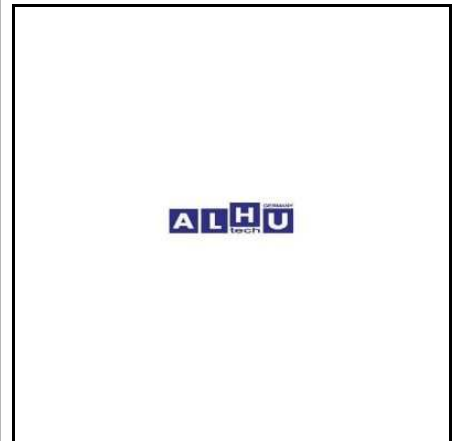

Kabine / Cabin

**18 724 446 WINDOW LIFTER**

**Mercedes Benz**  
126 720 14 46



**18 724 546 WINDOW LIFTER**  
without motor, front, left

**Mercedes Benz**  
202 720 15 46



**18 724 646 WINDOW LIFTER**  
without motor, front

**Mercedes Benz**  
202 720 16 46



**18 730 046 WINDOW LIFTER**  
without motor, rear, left

W126

**Mercedes Benz**  
126 730 09 46



Kabine / Cabin

<b>18 730 146</b>	<b>WINDOW LIFTER</b>
	without motor, rear, right
	W126
<b>Mercedes Benz</b>	
126 730 10 46	



<b>18 730 546</b>	<b>WINDOW LIFTER</b>
	without motor, rear, left
	W210
<b>Mercedes Benz</b>	
210 730 15 46	



<b>18 730 646</b>	<b>WINDOW LIFTER</b>
	without motor, rear, right
	W210
<b>Mercedes Benz</b>	
210 730 16 46	



<b>18 731 146</b>	<b>WINDOW LIFTER</b>
	without motor, rear, left
	W140
<b>Mercedes Benz</b>	
140 730 11 46	



Kabine / Cabin

<b>18 731 246</b>	<b>WINDOW LIFTER</b>
	without motor, rear, right
	W140
<b>Mercedes Benz</b>	
140 730 12 46	

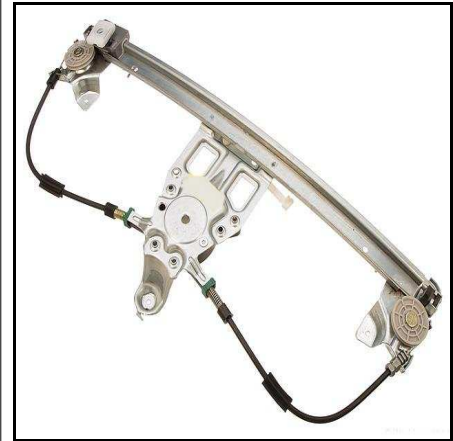

<b>18 731 346</b>	<b>WINDOW LIFTER</b>
	without motor, rear, left
	W124
<b>Mercedes Benz</b>	
124 730 03 46	

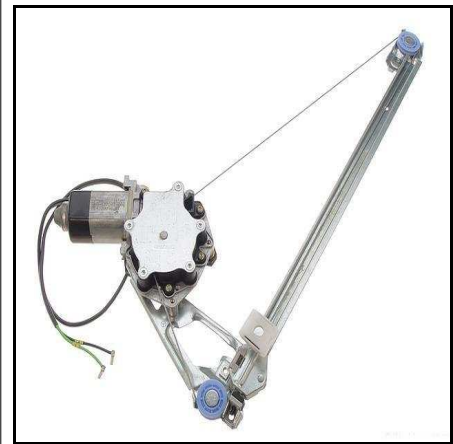

<b>18 731 446</b>	<b>WINDOW LIFTER</b>
	without motor, rear, right
	W124
<b>Mercedes Benz</b>	
124 730 04 46	

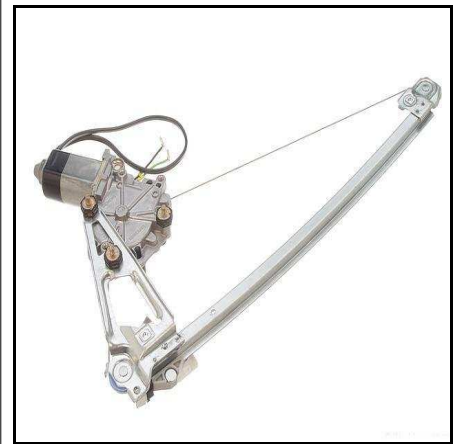

<b>18 731 546</b>	<b>WINDOW LIFTER</b>
	without motor, rear, left
	W220
<b>Mercedes Benz</b>	
220 730 03 46	



**Kabine / Cabin**

<b>18 731 646</b>	<b>WINDOW LIFTER</b>
	without motor, rear, right
	W220
<b>Mercedes Benz</b>	
220 730 04 46	



<b>18 731 746</b>	<b>WINDOW LIFTER</b>
	rear, left
	W220
<b>Mercedes Benz</b>	
220 730 23 46	



<b>18 731 846</b>	<b>WINDOW LIFTER</b>
	rear, right
	W220
<b>Mercedes Benz</b>	
220 730 24 46	



<b>18 732 246</b>	<b>WINDOW LIFTER</b>
	without motor, rear, left
	W163
<b>Mercedes Benz</b>	
163 730 01 46	

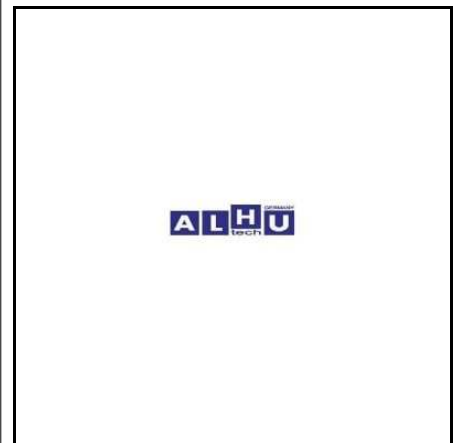



Kabine / Cabin

**18 732 346**    **WINDOW LIFTER**  
without motor, rear, right  
W163

**Mercedes Benz**  
163 730 02 46

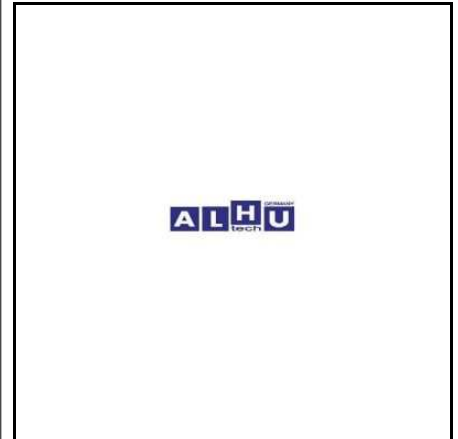

**18 732 446**    **WINDOW LIFTER**  
without motor, rear, left  
W163

**Mercedes Benz**  
163 730 09 46

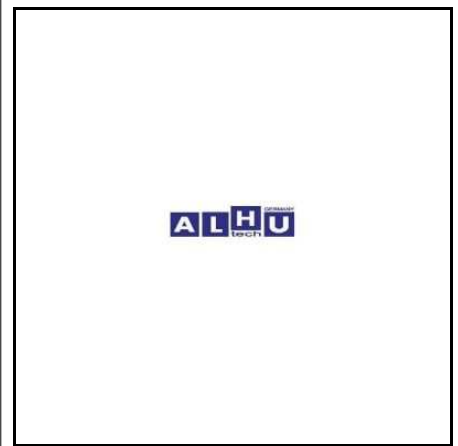

**18 732 546**    **WINDOW LIFTER**  
without motor, rear, right

**Mercedes Benz**  
163 730 10 46

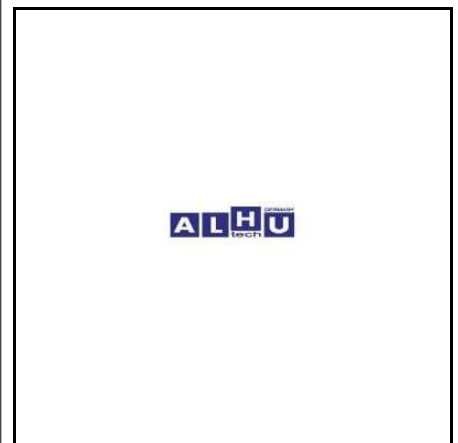

**18 734 346**    **WINDOW LIFTER**  
without motor, rear

**Mercedes Benz**  
202 730 13 46



Kabine / Cabin

**18 734 446 WINDOW LIFTER**  
without motor, rear  
W202

**Mercedes Benz**  
202 730 14 46



**18 869 121 WINDSHIELD WASHER PUMP**

**Mercedes Benz**  
124 869 03 21  
124 869 05 21  
129 869 00 21



**18 869 221 WINDSHIELD WASHER PUMP**

**Mercedes Benz**  
140 869 00 21  
140 869 02 21



**18 869 321 WINDSHIELD WASHER PUMP**

**Mercedes Benz**  
124 869 02 21



Kabine / Cabin

**18 869 421 WINDSHIELD WASHER PUMP**

**Mercedes Benz**  
210 869 08 21



**18 869 521 WINDSHIELD WASHER PUMP**

W 168 W 169 W 210

**Mercedes Benz**  
210 869 10 21



**18 869 621 WINDSHIELD WASHER PUMP**

W 202

**Mercedes Benz**  
202 869 00 21  
202 869 01 21



**16 820 001 WIPER MOTOR**

W140

**Mercedes Benz**  
140 820 22 42

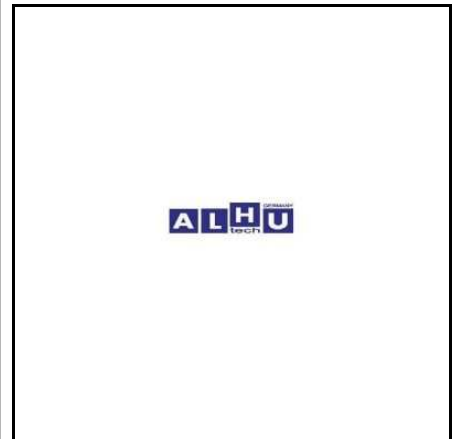

Kabine / Cabin

16 820 002 WIPER MOTOR	
	W220
<p><b>Mercedes Benz</b> 220 820 07 42</p>	



16 820 408 WIPER MOTOR	
	W202
<p><b>Mercedes Benz</b> 202 820 24 08</p>	



16 820 442 WIPER MOTOR	
	W202
<p><b>Mercedes Benz</b> 202 820 64 42</p>	



18 820 043 WIPER MOTOR	
	W210
<p><b>Mercedes Benz</b> 210 820 17 42</p>	
<p><b>Bosch</b> 0 390 241 420</p>	



Kabine / Cabin

**18 820 143 WIPER MOTOR**

W140

**Mercedes Benz**  
140 820 00 08

**Bosch**  
0 390 341 403



**18 820 243 WIPER MOTOR**

W163

**Mercedes Benz**  
163 820 43 42



**18 820 308 WIPER MOTOR**

W202

**Mercedes Benz**  
202 820 23 08



**18 820 343 WIPER MOTOR**

W163

**Mercedes Benz**  
163 820 44 42



Kabine / Cabin

**18 820 443 WIPER MOTOR**

W124

**Mercedes Benz**  
124 820 07 08

**Bosch**  
0 390 241 425



**18 820 543 WIPER MOTOR**

W210

**Mercedes Benz**  
210 820 18 42

**Bosch**  
0 390 241 429



**18 820 643 WIPER MOTOR**

W201

**Mercedes Benz**  
201 820 36 42



**18 820 743 WIPER MOTOR**

W202

**Mercedes Benz**  
202 820 04 08

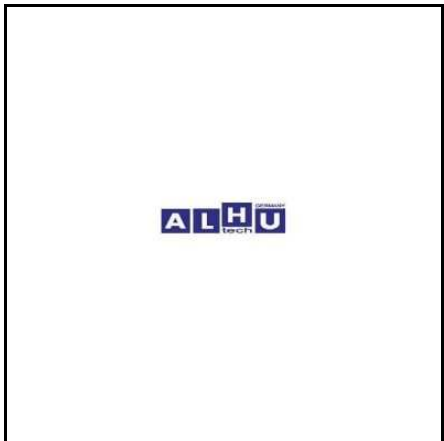

Kabine / Cabin

18 821 143	WIPER MOTOR
	W202
<b>Mercedes Benz</b>	
202 820 03 08	



18 821 342	WIPER MOTOR
	W202
<b>Mercedes Benz</b>	
202 820 53 42	



Lenkung / Steering

**13 333 327 BALL JOINT**

**Mercedes Benz**  
140 333 03 27



**13 338 415 BALL JOINT**

**Mercedes Benz**  
210 338 04 15



**11 330 001 CONTROL ARM**

W 202 W 210

**Mercedes Benz**  
210 330 87 07

**LMI**  
2174902



**11 330 002 CONTROL ARM**

W 202 W 210

**Mercedes Benz**  
210 330 88 07

**LMI**  
2175002





Lenkung / Steering

**11 330 003 CONTROL ARM**

**Mercedes Benz**  
203 330 01 11



**11 330 004 CONTROL ARM**

**Mercedes Benz**  
203 330 02 11



**11 330 005 CONTROL ARM**

**Mercedes Benz**  
203 330 19 11  
203 330 33 11



**11 330 006 CONTROL ARM**

**Mercedes Benz**  
203 330 34 11



Lenkung / Steering

**11 330 007 CONTROL ARM**

W 220

**Mercedes Benz**  
220 330 83 07  
220 330 93 07



**11 330 008 CONTROL ARM**

W 220

**Mercedes Benz**  
220 330 84 07  
220 330 94 07



**11 330 009 CONTROL ARM**

W 220

**Mercedes Benz**  
220 330 57 11

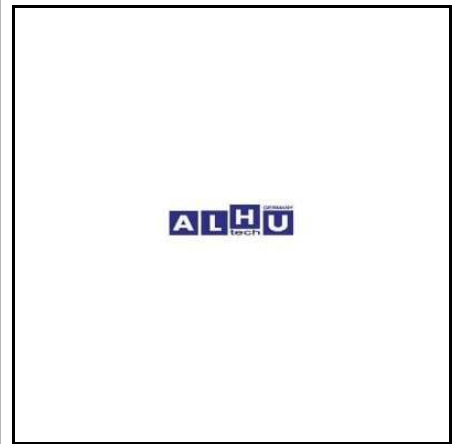

**11 330 010 CONTROL ARM**

W 220

**Mercedes Benz**  
220 330 58 11

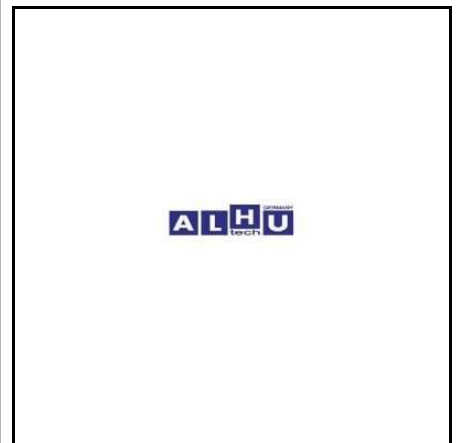

Lenkung / Steering

**11 330 011 CONTROL ARM**

W 220

**Mercedes Benz**  
220 330 90 07

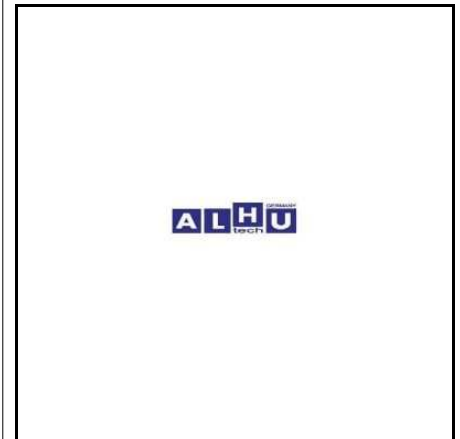

**11 330 012 CONTROL ARM**

W 220

**Mercedes Benz**  
220 330 89 07

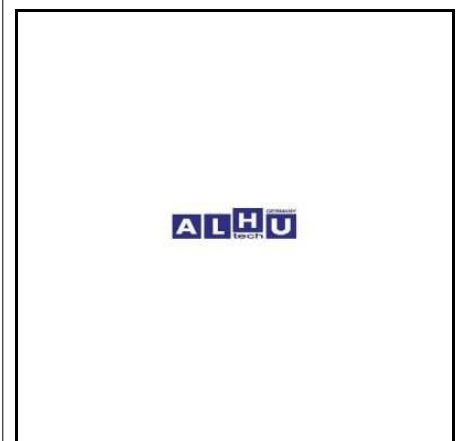

**13 330 307 CONTROL ARM**

W 123

**Mercedes Benz**  
123 330 46 07



**13 330 407 CONTROL ARM**

W 123

**Mercedes Benz**  
123 330 47 07



Lenkung / Steering

**13 330 507 CONTROL ARM**

W 126

**Mercedes Benz**  
126 330 06 07



**13 330 607 CONTROL ARM**

W 126

**Mercedes Benz**  
126 330 07 07



**13 330 707 CONTROL ARM**

W 140

**Mercedes Benz**  
140 330 77 07



**13 333 001 CONTROL ARM**

W 163

**Mercedes Benz**  
163 333 00 01



Lenkung / Steering

**13 333 101 CONTROL ARM**

W 163

**Mercedes Benz**  
163 333 01 01



**13 350 206 CONTROL ARM**

**Mercedes Benz**  
210 350 16 06  
210 350 17 06  
210 350 24 06



**13 350 406 CONTROL ARM**

W 140

**Mercedes Benz**  
140 350 34 06

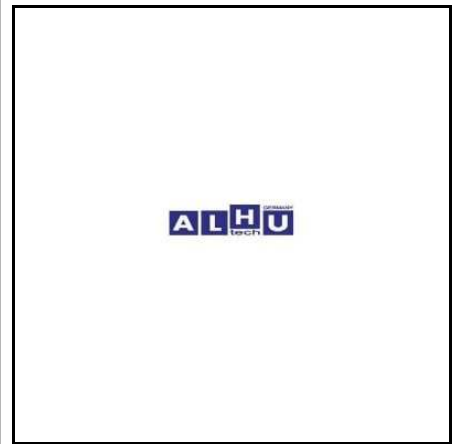

**13 350 506 CONTROL ARM**

W 140

**Mercedes Benz**  
140 350 35 06

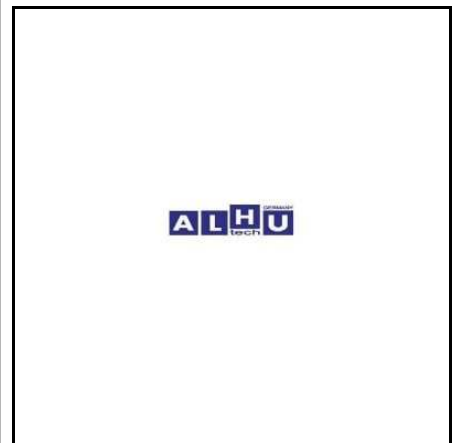

Lenkung / Steering

**13 350 606 CONTROL ARM**

W 140

**Mercedes Benz**  
140 350 36 06



**11 352 165 CONTROL ARM BUSHING**

**Mercedes Benz**  
202 352 01 65

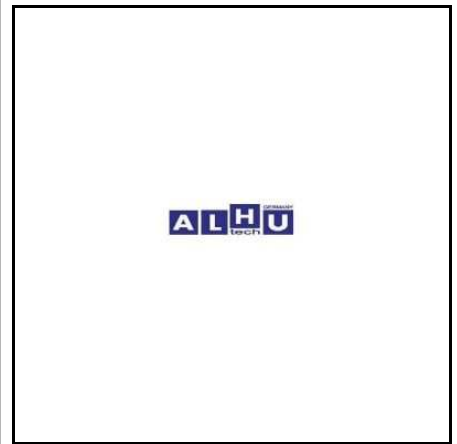

**11 352 166 CONTROL ARM BUSHING**

**Mercedes Benz**  
203 333 09 14

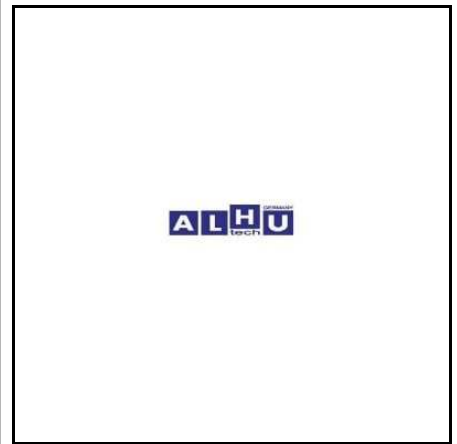

**11 352 168 CONTROL ARM BUSHING**

**Mercedes Benz**  
210 333 68 14

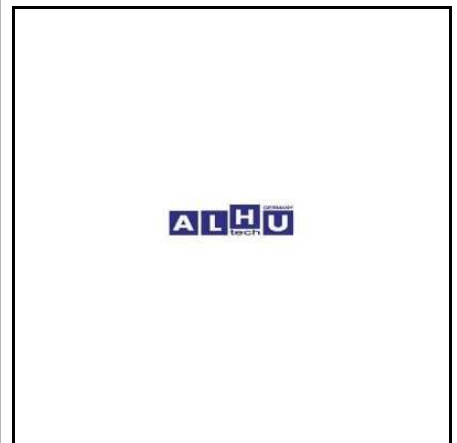

Lenkung / Steering

**11 352 169 CONTROL ARM BUSHING**

**Mercedes Benz**  
211 333 10 14



**13 351 742 CONTROL ARM BUSHING**

**Mercedes Benz**  
201 351 27 42



**11 000 000 CONTROL ARM KIT**

**Mercedes Benz**  
115 330 18 75



**11 000 002 CONTROL ARM KIT**

**Mercedes Benz**  
123 350 00 75



Lenkung / Steering

**13 330 207 CONTROL ARM KIT**

**Mercedes Benz**  
140 330 82 07

**LMI**  
1100601

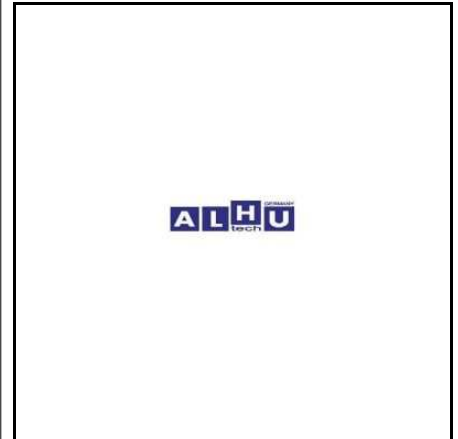

**13 330 575 CONTROL ARM KIT**

**Mercedes Benz**  
124 330 05 75



**13 330 675 CONTROL ARM KIT**

**Mercedes Benz**  
115 330 16 75



**13 330 775 CONTROL ARM KIT**

**Mercedes Benz**  
124 330 07 75

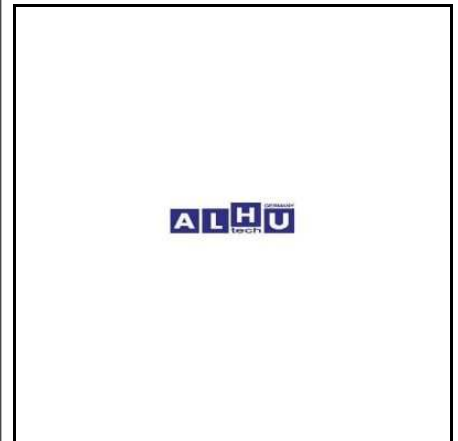



Lenkung / Steering

**13 330 875 CONTROL ARM KIT**

**Mercedes Benz**  
115 330 17 75



**13 330 975 CONTROL ARM KIT**

**Mercedes Benz**  
124 330 09 75



**13 331 075 CONTROL ARM KIT**

**Mercedes Benz**  
202 330 00 75



**13 331 175 CONTROL ARM KIT**

**Mercedes Benz**  
123 330 13 75



Lenkung / Steering

**13 331 275 CONTROL ARM KIT**

**Mercedes Benz**  
123 330 14 75



**13 331 375 CONTROL ARM KIT**

**Mercedes Benz**  
124 330 06 75



**13 331 475 CONTROL ARM KIT**

**Mercedes Benz**  
210 330 04 75



**13 331 575 CONTROL ARM KIT**

**Mercedes Benz**  
126 330 00 75



Lenkung / Steering

**13 331 675 CONTROL ARM KIT**

**Mercedes Benz**  
201 330 00 75



**13 350 175 CONTROL ARM KIT**

**Mercedes Benz**  
126 350 01 75



**10 000 027 DRAG LINK**

**Mercedes Benz**  
202 460 04 05



**11 460 183 EXPANSION TANK, POWER STEERING**

W 202 W 203 W 210

**Mercedes Benz**  
000 460 01 83

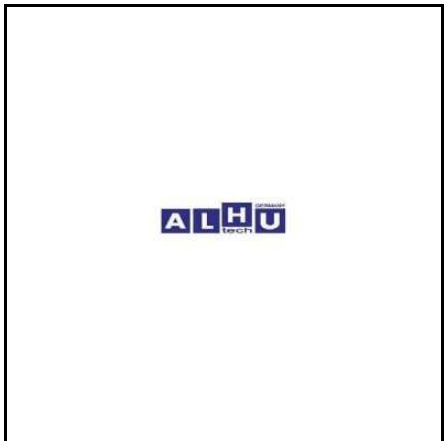

Lenkung / Steering

17 460 005 GASKET SET STEERING PUMP

**Mercedes Benz**  
000 460 44 80

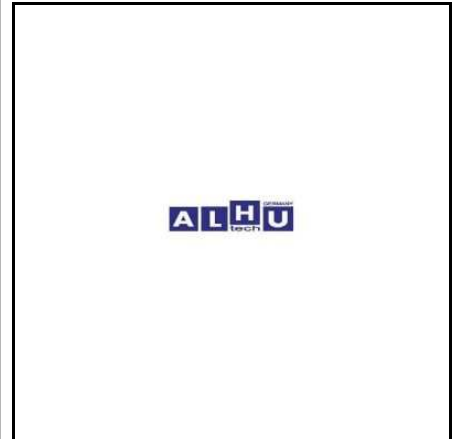

16 124 460 GASKET SET STEERING PUMP

**Mercedes Benz**  
124 460 01 61

**TA501**  
634034

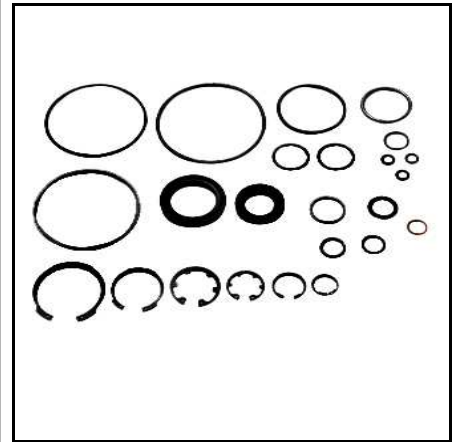

16 140 460 GASKET SET STEERING PUMP

**Mercedes Benz**  
124 460 29 01  
140 460 29 01



17 460 001 GASKET SET STEERING PUMP

**Mercedes Benz**  
210 460 00 61

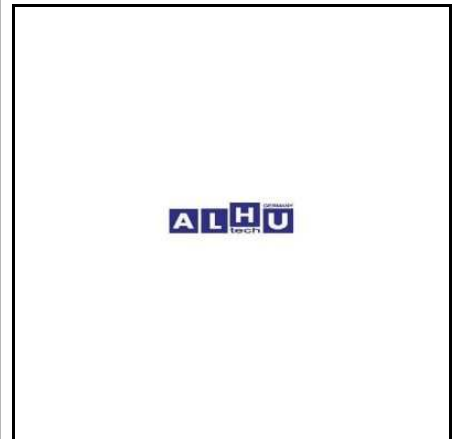

Lenkung / Steering

**17 460 004 GASKET SET STEERING PUMP**

**Mercedes Benz**  
000 460 47 80



**63 512 0 GASKET SET STEERING PUMP**

**Mercedes Benz**  
000 460 47 80



**634034 GASKET SET STEERING PUMP**

**Mercedes Benz**  
124 460 01 61

**ALHU tech**  
16 124 460



**14 460 040 LOCK CYLINDER**

W 202 W 210

**Mercedes Benz**  
202 460 07 04



Lenkung / Steering

**14 460 104 LOCK CYLINDER**

**Mercedes Benz**  
201 460 01 04



**14 460 140 LOCK CYLINDER**

**Mercedes Benz**  
202 460 11 04



**14 460 404 LOCK CYLINDER**

**Mercedes Benz**  
140 460 14 04



**14 460 640 LOCK CYLINDER**  
with key

**Mercedes Benz**  
126 460 06 04



Lenkung / Steering

**14 462 479 LOCK CYLINDER**

**Mercedes Benz**  
123 462 04 79



**16 203 320 STEERING DAMPER**

**Mercedes Benz**  
140 463 03 32



**16 304 320 STEERING DAMPER**

**Mercedes Benz**  
124 463 04 32



**16 305 320 STEERING DAMPER**

**Mercedes Benz**  
000 463 51 32



Lenkung / Steering

**16 126 227 STEERING RACK GASKET SET**

W 163

**ALHU tech**  
63 622 7



**16 126 461 STEERING RACK GASKET SET**

**ALHU tech**  
63 622 5



**17 460 002 STEERING RACK GASKET SET**

**ALHU tech**  
63 622 6



**17 460 007 STEERING RACK GASKET SET**

**ALHU tech**  
636203





Lenkung / Steering

**636203 STEERING RACK GASKET SET**

W 210

**ALHU tech**  
17 460 007

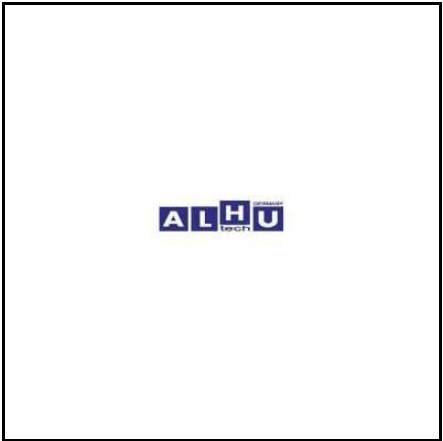

**63 622 5 STEERING RACK GASKET SET**

**ALHU tech**  
16 126 461

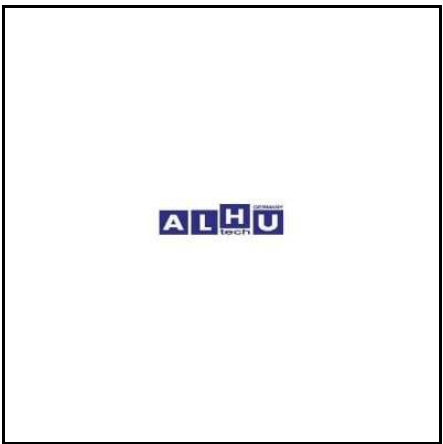

**63 622 7 STEERING RACK GASKET SET**

W 163

**ALHU tech**  
16 126 227

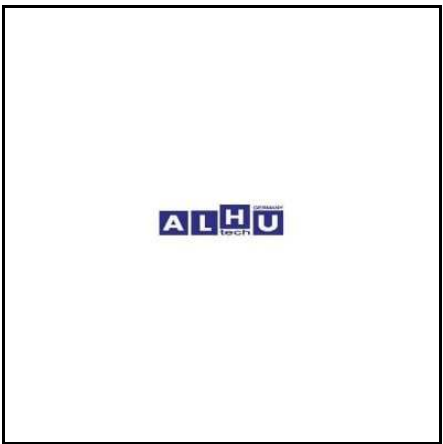

**63 920 3 STEERING RACK GASKET SET**

complete

W 210

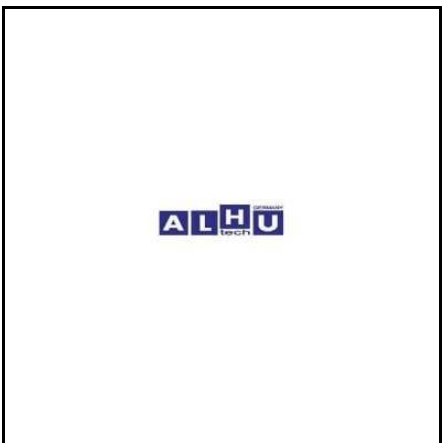

Lenkung / Steering

**13 330 003 TIE ROD**

**Mercedes Benz**  
140 330 00 03



**13 350 753 TIE ROD**

**Mercedes Benz**  
210 350 18 53



Motor / Engine

**11 300 030 ACCELERATION CABLE**

**Mercedes Benz**  
201 300 30 30



**11 300 130 ACCELERATION CABLE**

**Mercedes Benz**  
202 300 01 30



**11 300 330 ACCELERATION CABLE**

**Mercedes Benz**  
124 300 12 30



**11 300 430 ACCELERATION CABLE**

**Mercedes Benz**  
124 300 50 30

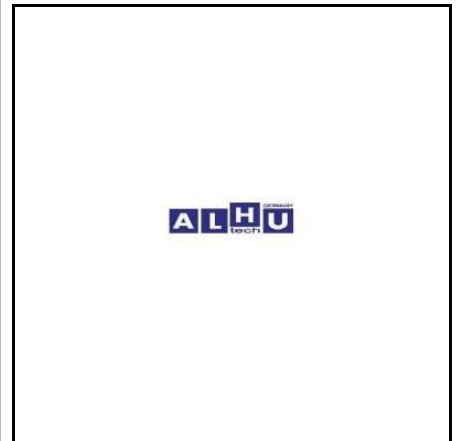

Motor / Engine

**11 300 530 ACCELERATION CABLE**

W 124

**Mercedes Benz**  
124 300 15 30



**11 300 630 ACCELERATION CABLE**

**Mercedes Benz**  
124 300 67 30

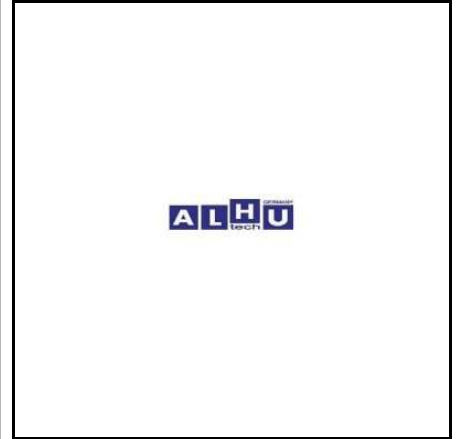

**11 300 730 ACCELERATION CABLE**

**Mercedes Benz**  
201 300 27 30



**11 300 830 ACCELERATION CABLE**

**Mercedes Benz**  
124 300 43 30

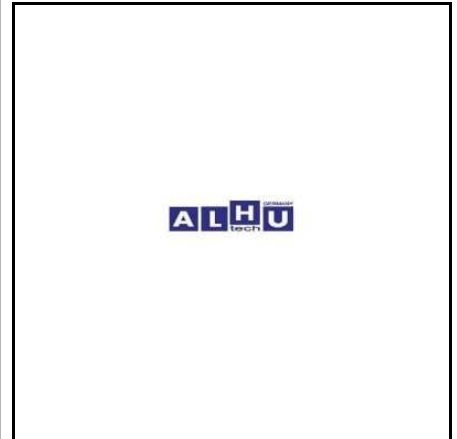

Motor / Engine

**21 300 030 ACCELERATION CABLE**

**Mercedes Benz**  
901 300 10 30

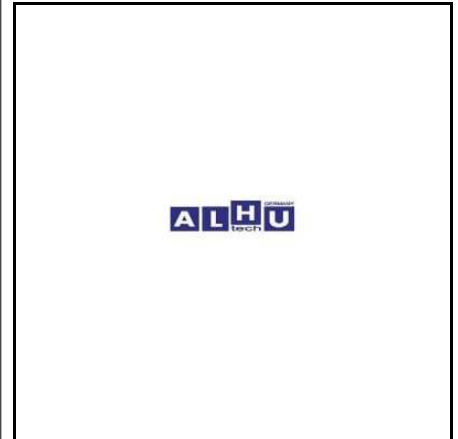

**21 301 030 ACCELERATION CABLE**

**Mercedes Benz**  
901 300 16 30  
901 300 17 30

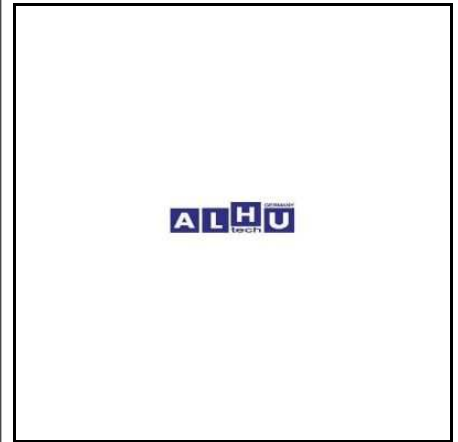

**11 094 248 AIR MASS SENSOR**

**Mercedes Benz**  
112 094 00 48

**Bosch**  
0 280 217 515

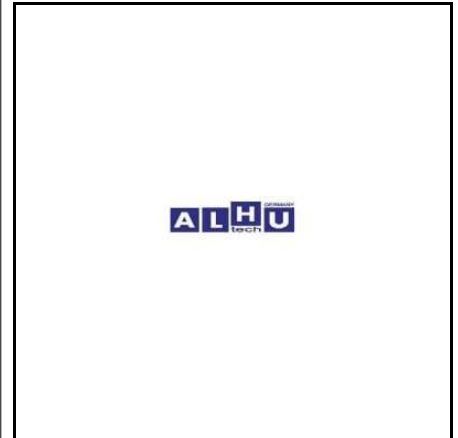

**11 094 348 AIR MASS SENSOR**

**Mercedes Benz**  
000 094 09 48



**Motor / Engine**

**11 094 448 AIR MASS SENSOR**

**Mercedes Benz**  
000 094 10 48



**11 094 548 AIR MASS SENSOR**

**Mercedes Benz**  
113 094 00 48



**11 094 648 AIR MASS SENSOR**

**Mercedes Benz**  
000 094 00 48

**Bosch**  
0 280 217 100



**11 094 748 AIR MASS SENSOR**

**Mercedes Benz**  
000 094 08 48

**Bosch**  
0 280 217 509



Motor / Engine

**11 094 948 AIR MASS SENSOR**

**Mercedes Benz**  
111 094 01 48

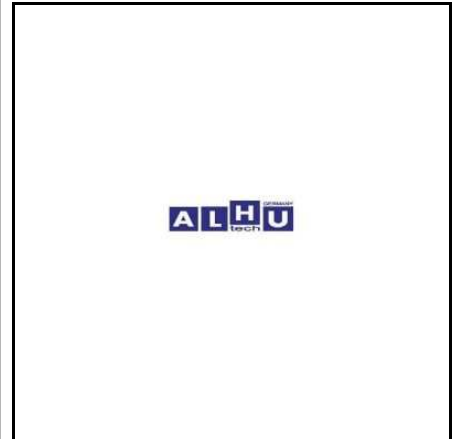

**11 095 248 AIR MASS SENSOR**

**Mercedes Benz**  
611 094 00 48



**11 095 348 AIR MASS SENSOR**

**Mercedes Benz**  
000 094 05 48

**Bosch**  
0 280 217 517



**11 201 570 BEARING JOURNAL**

**Mercedes Benz**  
606 202 01 20



Motor / Engine

**11 200 003 BELT TENSIONER**

**Mercedes Benz**  
102 200 77 70

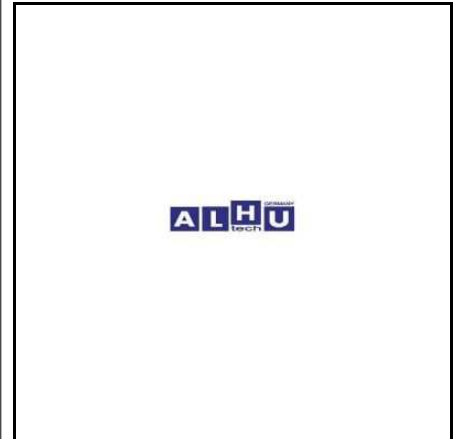

**11 200 270 BELT TENSIONER**

**Mercedes Benz**  
102 200 69 70



**11 200 271 BELT TENSIONER**

**Mercedes Benz**  
272 200 02 70



**11 200 370 BELT TENSIONER**

**Mercedes Benz**  
111 200 07 70

**VW**  
00A 903 315





Motor / Engine

**11 200 470 BELT TENSIONER**

**Mercedes Benz**  
103 200 08 70

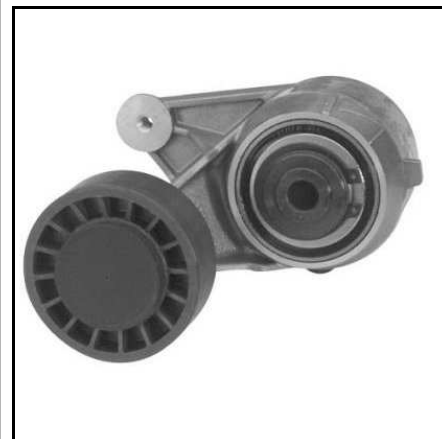

**11 200 870 BELT TENSIONER**

**Mercedes Benz**  
104 200 08 70

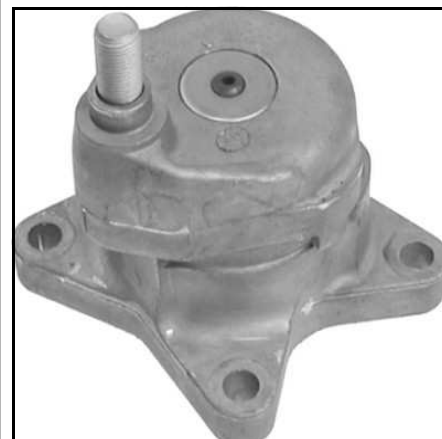

**11 201 170 BELT TENSIONER**

**Mercedes Benz**  
119 200 11 70

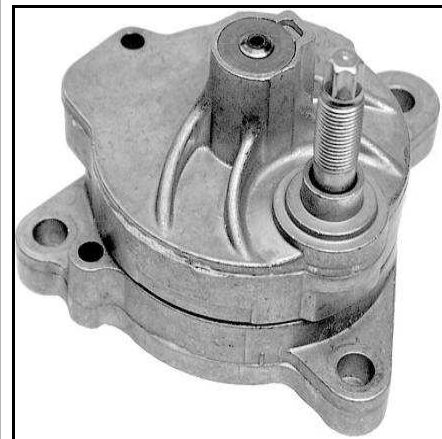

**11 201 270 BELT TENSIONER**

**Mercedes Benz**  
119 200 02 70



Motor / Engine

**11 201 370 BELT TENSIONER**

**Mercedes Benz**  
120 200 03 70



**11 202 070 BELT TENSIONER**

**Mercedes Benz**  
104 200 05 70



**11 202 170 BELT TENSIONER**

**Mercedes Benz**  
120 200 04 70



**11 202 270 BELT TENSIONER**

**Mercedes Benz**  
611 200 03 70  
611 200 05 70  
646 200 02 70

**Dayco**  
APV2232

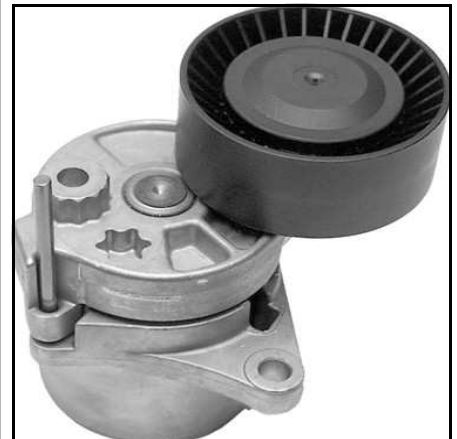

Motor / Engine

**11 205 470 BELT TENSIONER**

**Mercedes Benz**  
119 200 04 70

**LMI**  
1249901

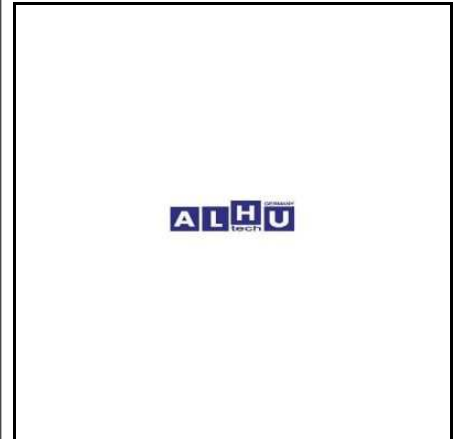

**11 206 270 BELT TENSIONER**

**Mercedes Benz**  
271 200 02 70

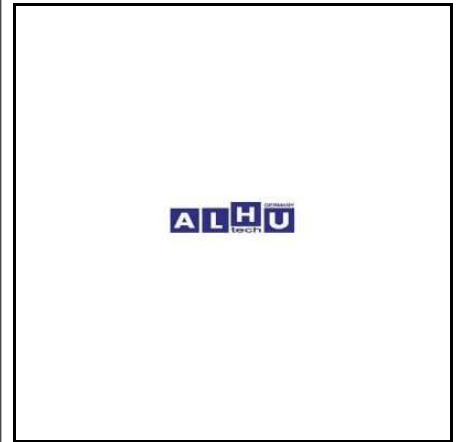

**11 201 870 BELT TENSIONER LEVER**

**Mercedes Benz**  
601 200 17 73



**11 200 004 BELT TENSIONER PULLEY**

**Mercedes Benz**  
116 130 01 60

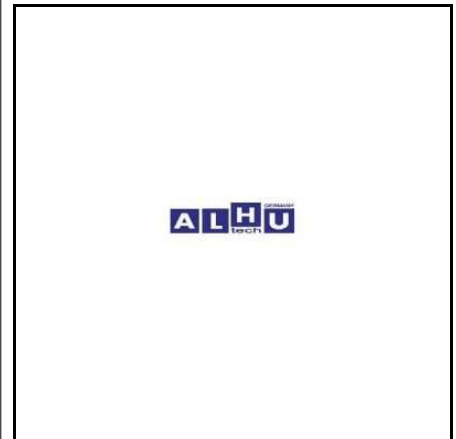

Motor / Engine

**11 200 005 BELT TENSIONER PULLEY**

**Mercedes Benz**  
601 200 12 70

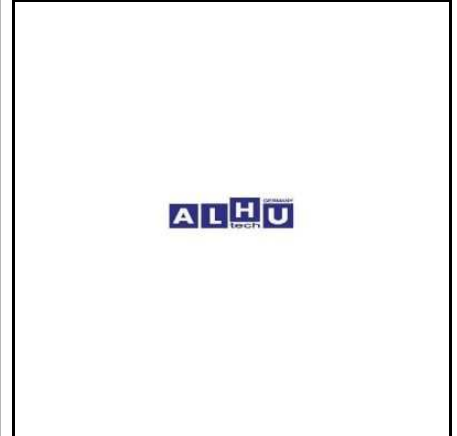

**11 200 006 BELT TENSIONER PULLEY**

**Mercedes Benz**  
611 155 02 15



**11 200 008 BELT TENSIONER PULLEY**

**Mercedes Benz**  
272 202 10 19



**11 200 019 BELT TENSIONER PULLEY**

**Mercedes Benz**  
000 202 00 19  
000 202 09 19

**VW**  
059 903 341 A

**Dayco**  
APV2134



Motor / Engine

**11 200 020 BELT TENSIONER PULLEY**

**Mercedes Benz**  
166 202 06 19

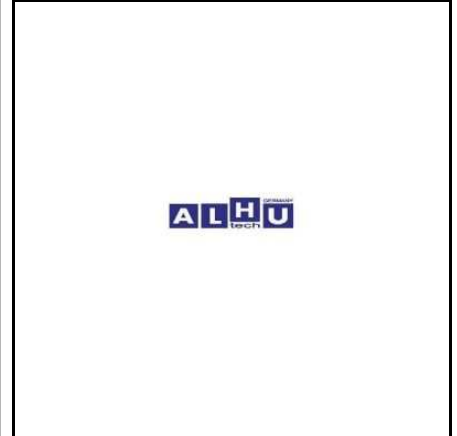

**11 200 021 BELT TENSIONER PULLEY**

**Mercedes Benz**  
137 202 01 19



**11 200 024 BELT TENSIONER PULLEY**

**Mercedes Benz**  
266 202 00 19

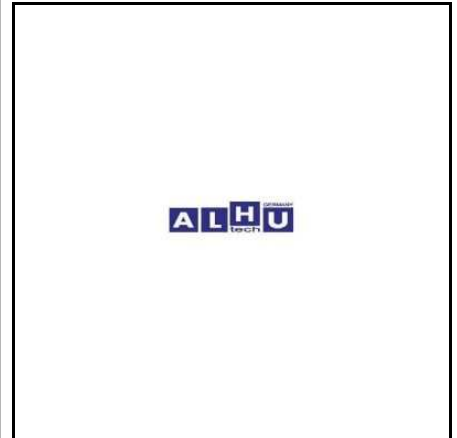

**11 200 027 BELT TENSIONER PULLEY**

**Mercedes Benz**  
640 202 04 19

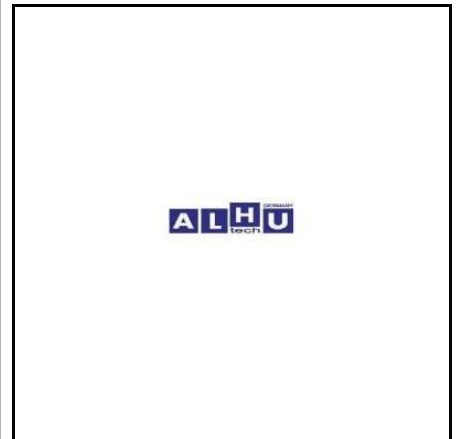

Motor / Engine

**11 200 070 BELT TENSIONER PULLEY**

**Mercedes Benz**  
104 200 10 70

**LMI**  
2954401



**11 200 119 BELT TENSIONER PULLEY**

**Mercedes Benz**  
111 202 01 19

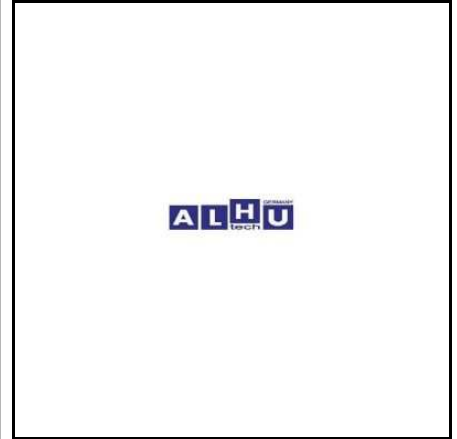

**11 200 170 BELT TENSIONER PULLEY**

**Mercedes Benz**  
601 200 10 70

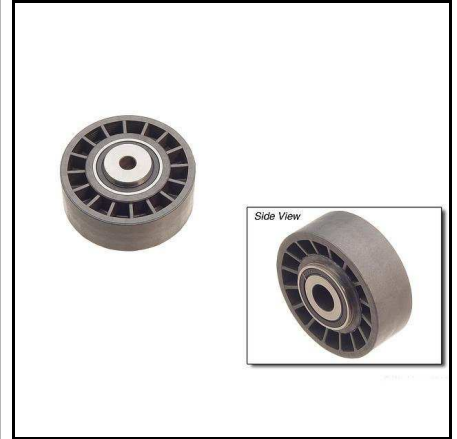

**11 200 272 BELT TENSIONER PULLEY**

**Mercedes Benz**  
272 202 14 19

**BMW**  
11 28 7 535 860

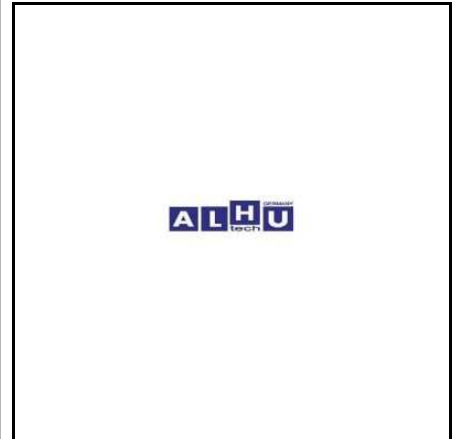

Motor / Engine

**11 200 319 BELT TENSIONER PULLEY**

**Mercedes Benz**  
000 202 03 19

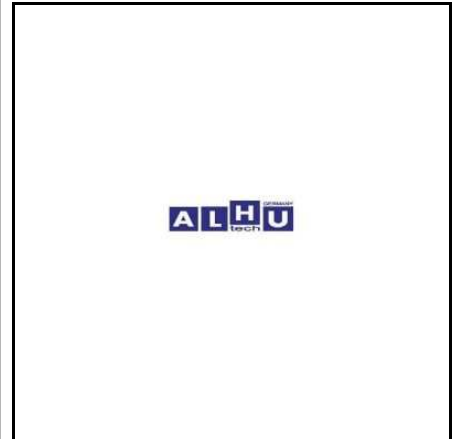

**11 200 570 BELT TENSIONER PULLEY**

**Mercedes Benz**  
103 200 05 70



**11 200 670 BELT TENSIONER PULLEY**

**Mercedes Benz**  
111 200 00 70

**VW**  
00A 903 341

**LMI**  
2822601



**11 200 770 BELT TENSIONER PULLEY**

**Mercedes Benz**  
601 200 07 70



Motor / Engine

**11 200 970 BELT TENSIONER PULLEY**

**Mercedes Benz**  
601 200 09 70

**VW**  
062 145 278



**11 201 070 BELT TENSIONER PULLEY**

**Mercedes Benz**  
112 200 09 70

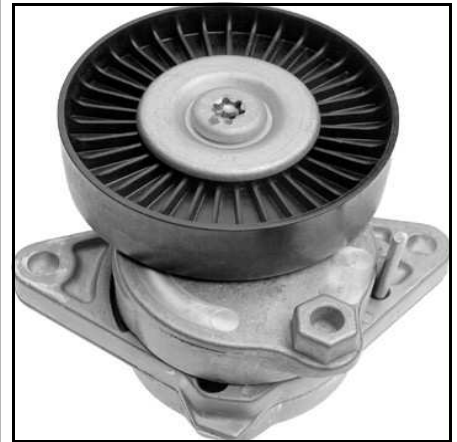

**11 201 670 BELT TENSIONER PULLEY**

**Mercedes Benz**  
119 200 03 70

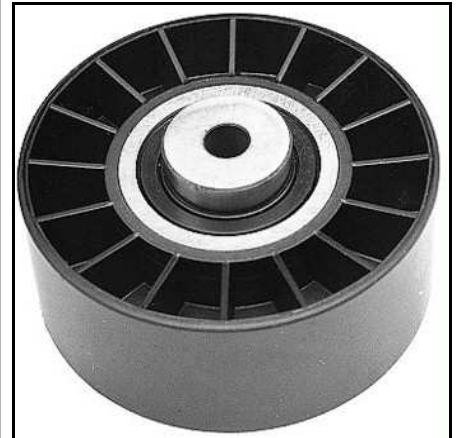

**11 201 970 BELT TENSIONER PULLEY**

**Mercedes Benz**  
119 200 14 70





Motor / Engine

**11 202 470 BELT TENSIONER PULLEY**

**Mercedes Benz**  
104 200 04 70



**11 500 001 BLOWER MOTOR**

**Mercedes Benz**  
220 500 00 93

**Behr/Hella**  
8EW 009 158-781

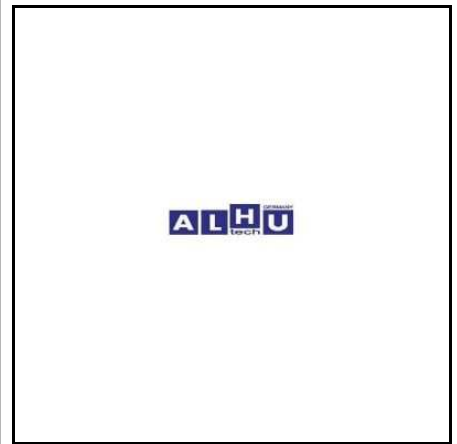

**11 500 093 BLOWER MOTOR**

**Mercedes Benz**  
000 500 79 93

**Bosch**  
0 130 703 200



**11 500 293 BLOWER MOTOR**

**Mercedes Benz**  
001 500 12 93

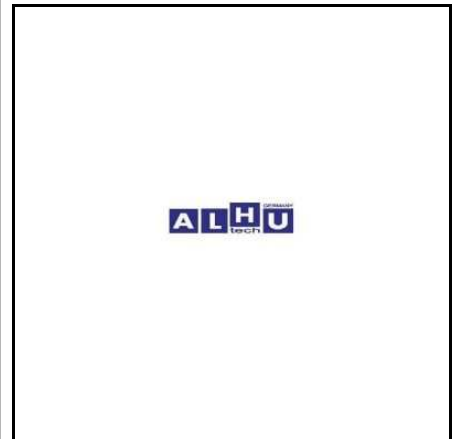

Motor / Engine

**11 500 393 BLOWER MOTOR**

**Mercedes Benz**  
001 500 13 93

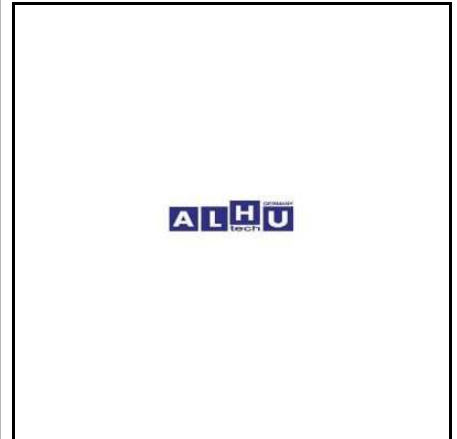

**11 500 493 BLOWER MOTOR**

**Mercedes Benz**  
001 500 16 93  
001 500 38 93



**11 500 593 BLOWER MOTOR**

**Mercedes Benz**  
000 500 85 93



**11 500 693 BLOWER MOTOR**

**Mercedes Benz**  
000 500 76 93



Motor / Engine

**11 500 793 BLOWER MOTOR**

**Mercedes Benz**  
001 500 05 93



**11 500 993 BLOWER MOTOR**

**Mercedes Benz**  
000 500 60 93



**11 500 994 BLOWER MOTOR**

**Mercedes Benz**  
000 500 70 93  
000 500 71 93

**Behr/Hella**  
8EW 009 144-731

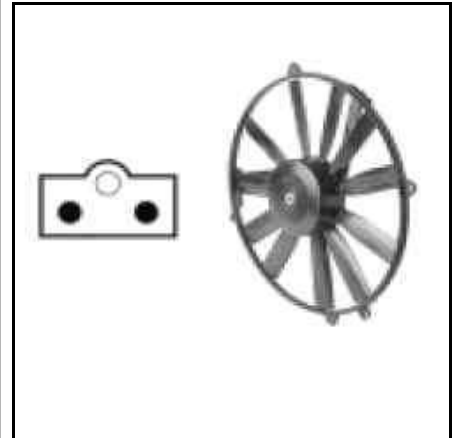

**11 500 996 BLOWER MOTOR**

**Mercedes Benz**  
001 830 57 08

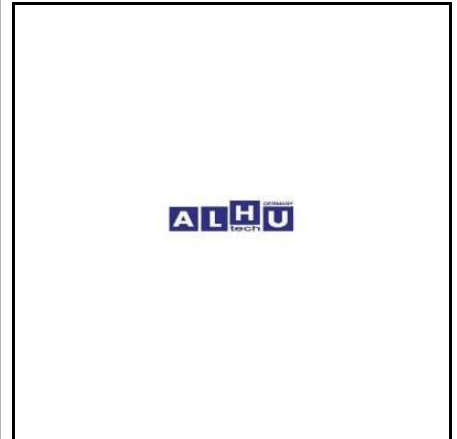

Motor / Engine

**11 094 091    BOOT**

**Mercedes Benz**  
601 094 03 91

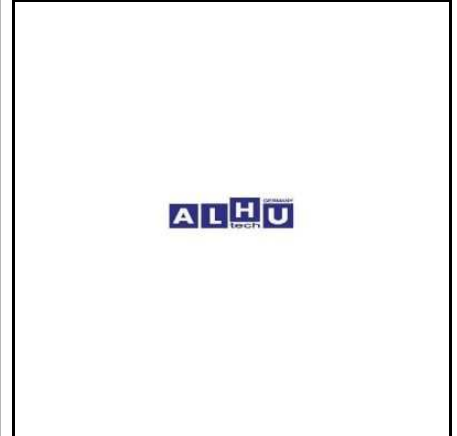

**63 451 420    BREATHER HOSE**



M 104

**Mercedes Benz**  
104 094 35 82



**63 451 421    BREATHER HOSE**



**Mercedes Benz**  
104 094 36 82

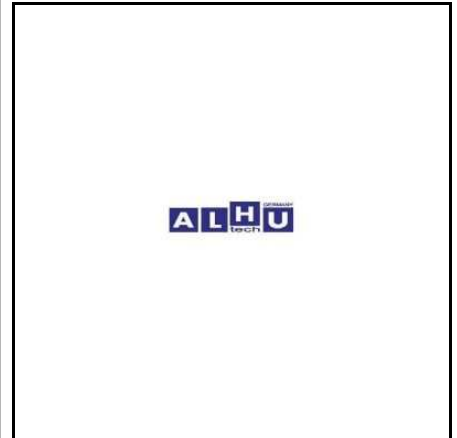

**11 981 027    BUSHING, TENSIONER PULLEY DRIVE**

**Mercedes Benz**  
601 981 00 27



Motor / Engine

**11 050 911 CHAIN ADJUSTER**

**Mercedes Benz**  
116 050 18 11  
117 050 09 11



**11 230 011 COMPRESSOR**

W 140 W 210 W 202

**Mercedes Benz**  
000 230 70 11



**16 230 011 COMPRESSOR**

**Mercedes Benz**  
000 230 90 11

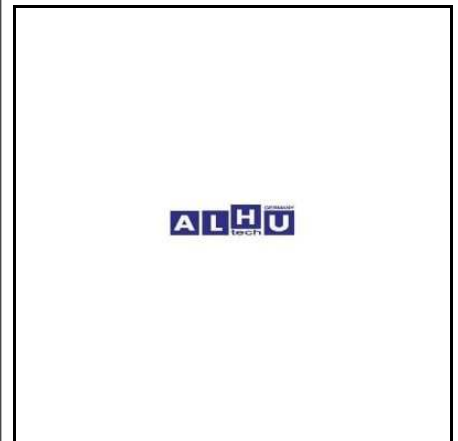

**16 230 111 COMPRESSOR**

**Mercedes Benz**  
000 230 91 11

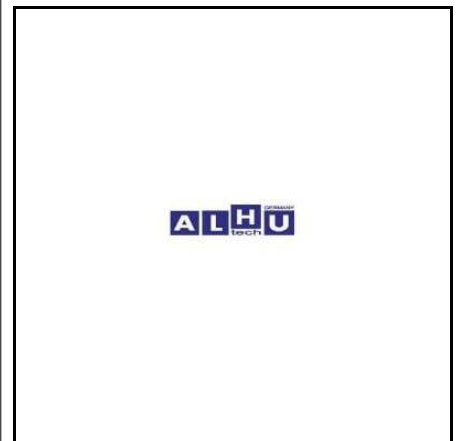

Motor / Engine

**11 830 070 CONDENSOR**

W 202

**Mercedes Benz**  
202 830 09 70

**Behr/Hella**  
8FC 351 037-331



**11 830 170 CONDENSOR**

W 124

**Mercedes Benz**  
124 830 12 70  
124 830 16 70

**Behr/Hella**  
8FC 351 035-771

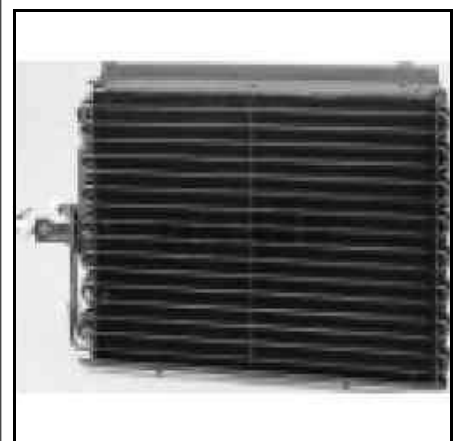

**11 830 254 CONDENSOR**

W 203

**Mercedes Benz**  
203 500 12 54

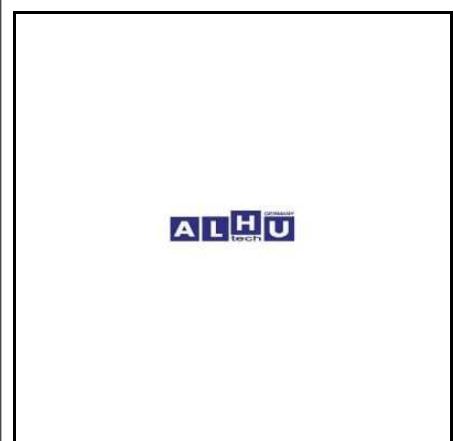

**11 830 270 CONDENSOR**

W 124

**Mercedes Benz**  
124 830 10 70  
124 830 17 70

**Behr/Hella**  
8FC 351 035-181



Motor / Engine

11 830 370 CONDENSOR	
	W 124
<p><b>Mercedes Benz</b> 124 830 19 70</p>	
<p><b>Behr/Hella</b> 8FC 351 301-481</p>	



11 830 470 CONDENSOR	
	W 126
<p><b>Mercedes Benz</b> 126 830 24 70</p>	



11 830 570 CONDENSOR	
	W 126
<p><b>Mercedes Benz</b> 126 830 27 70 126 830 28 70</p>	
<p><b>Behr/Hella</b> 8FC 351 317-441</p>	

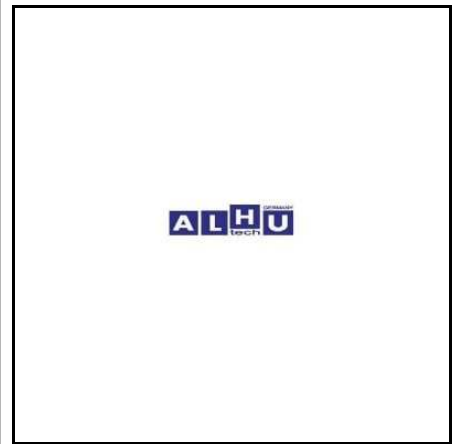

11 830 670 CONDENSOR	
	W 140
<p><b>Mercedes Benz</b> 140 830 05 70</p>	

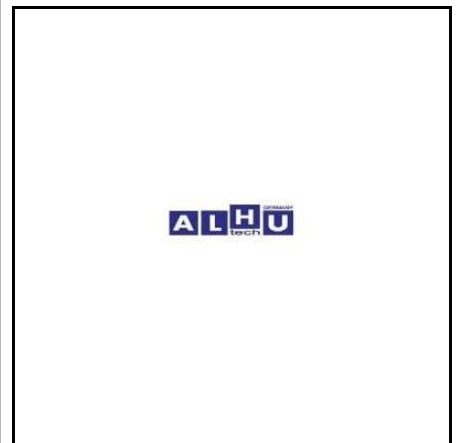

Motor / Engine

**11 830 770 CONDENSOR**

W 210

**Mercedes Benz**  
210 830 03 70

**Behr/Hella**  
8FC 351 037-171

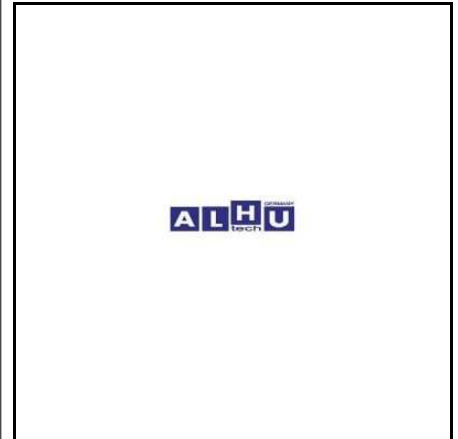

**11 830 870 CONDENSOR**

W 202

**Mercedes Benz**  
202 830 10 70

**Behr/Hella**  
8FC 351 038-451

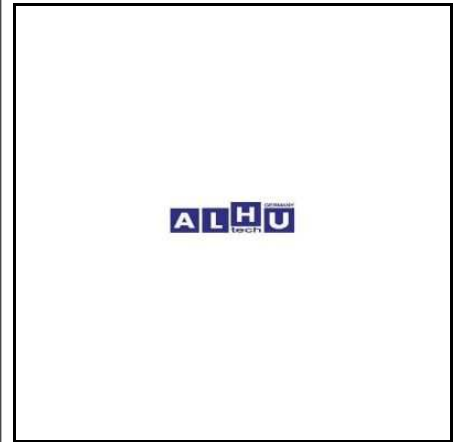

**11 830 970 CONDENSOR**

W 124

**Mercedes Benz**  
124 830 13 70

**Behr/Hella**  
8FC 351 035-191



**11 831 570 CONDENSOR**

W 210

**Mercedes Benz**  
210 830 02 70  
210 830 05 70

**Behr/Hella**  
8FC 351 036-761





Motor / Engine

**11 831 670 CONDENSOR**

W 202

**Mercedes Benz**  
202 830 05 70  
202 830 08 70

**Behr/Hella**  
8FC 351 036-011

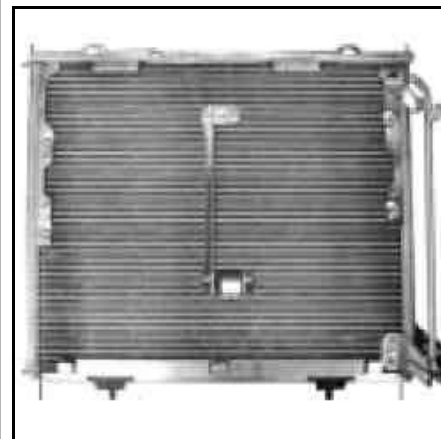

**11 831 770 CONDENSOR**

SPRINTER

**Mercedes Benz**  
901 500 05 54

**Behr/Hella**  
8FC 351 037-161



**11 831 870 CONDENSOR**

**Mercedes Benz**  
203 500 10 54

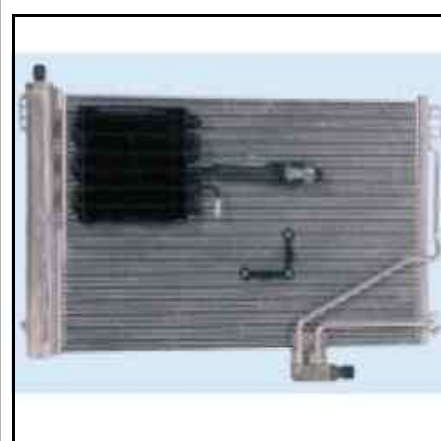

**11 831 970 CONDENSOR**

W 203

**Mercedes Benz**  
203 500 08 54

**Behr/Hella**  
8FC 351 317-501

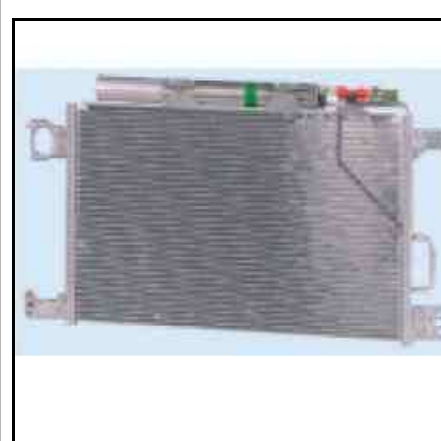

Motor / Engine

**11 832 070 CONDENSOR**

W 168

**Mercedes Benz**  
168 500 04 54

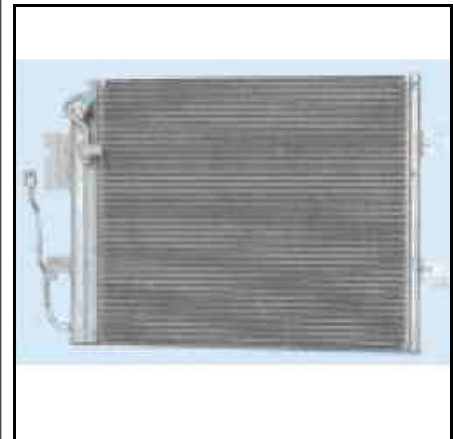

**11 832 170 CONDENSOR**

W 163

**Mercedes Benz**  
163 830 00 70  
163 830 01 70

**Behr/Hella**  
8FC 351 038-721

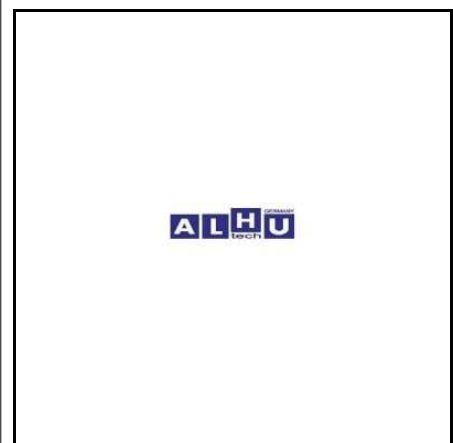

**11 832 270 CONDENSOR**

W 211

**Mercedes Benz**  
211 500 01 54

**Behr/Hella**  
8FC 351 300-711

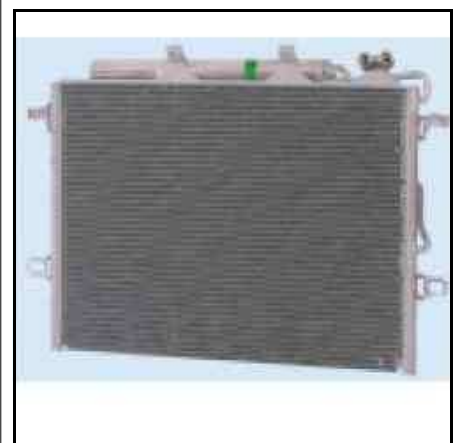

**11 832 370 CONDENSOR**

**Mercedes Benz**  
638 835 01 70

**Behr/Hella**  
8FC 351 037-341



Motor / Engine

**11 832 770 CONDENSOR**

W 201

**Mercedes Benz**  
201 830 22 70



**11 832 870 CONDENSOR**

W 201

**Mercedes Benz**  
201 830 12 70



**11 832 970 CONDENSOR**

W 201

**Mercedes Benz**  
201 830 28 70

**Behr/Hella**  
8FC 351 035-161



**21 830 054 CONDENSOR**

SPRINTER

**Mercedes Benz**  
906 500 00 54

**Behr/Hella**  
8FC 351 307-641



Motor / Engine

**63 451 422 COOLANT TEMPERATURE SENSOR**

 W140 W202 W210

**Mercedes Benz**  
005 153 63 28



**11 830 011 DRYER BOTTLE**

 W 140

**Mercedes Benz**  
140 830 01 83

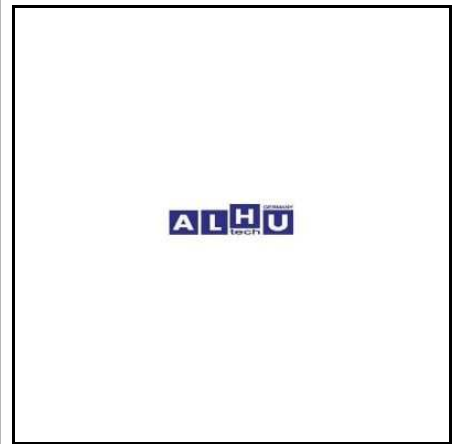

**11 830 012 DRYER BOTTLE**

 W 140

**Mercedes Benz**  
140 830 02 83

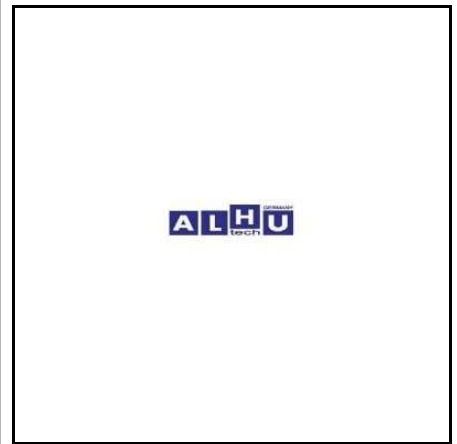

**11 830 013 DRYER BOTTLE**

 W 202

**Mercedes Benz**  
202 830 02 83

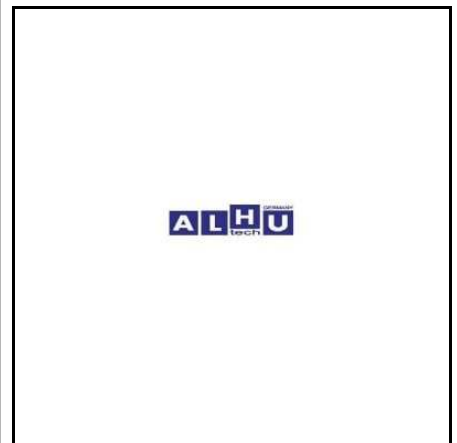

Motor / Engine

**11 830 014 DRYER BOTTLE**

 W 203 W 211

**Mercedes Benz**  
211 835 00 47

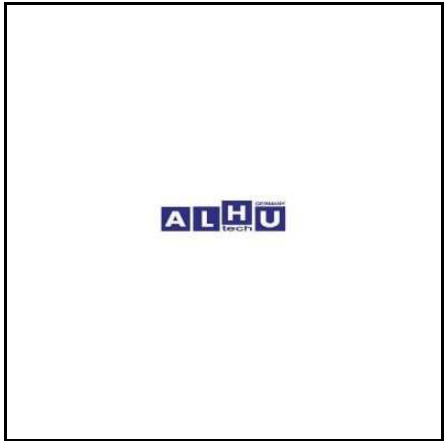

**11 830 083 DRYER BOTTLE**

W 220

**Mercedes Benz**  
220 830 00 83

**Behr/Hella**  
8FT 351 196-581



**11 830 183 DRYER BOTTLE**

**Mercedes Benz**  
107 830 14 83



**11 830 283 DRYER BOTTLE**

W 210

**Mercedes Benz**  
210 830 03 83

**Behr/Hella**  
8FT 351 196-561



Motor / Engine

**11 830 383 DRYER BOTTLE**

W 126

**Mercedes Benz**  
126 830 03 83



**11 830 883 DRYER BOTTLE**

W 210

**Mercedes Benz**  
210 830 04 83

**Behr/Hella**  
8FT 351 196-571



**11 830 983 DRYER BOTTLE**

**Mercedes Benz**  
115 835 04 71

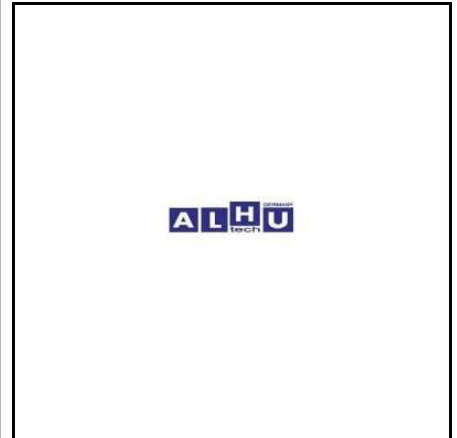

**11 831 083 DRYER BOTTLE**

W 201

**Mercedes Benz**  
201 830 00 83



Motor / Engine

**11 831 183 DRYER BOTTLE**

W 124

**Mercedes Benz**  
124 830 03 83



**11 500 758 EVAPORATOR**

W 124

**Mercedes Benz**  
124 830 07 58

**Behr/Hella**  
8FV 351 210-091

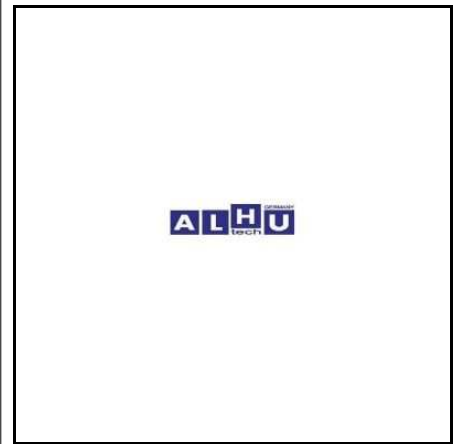

**11 830 958 EVAPORATOR**

**Mercedes Benz**  
210 830 09 58

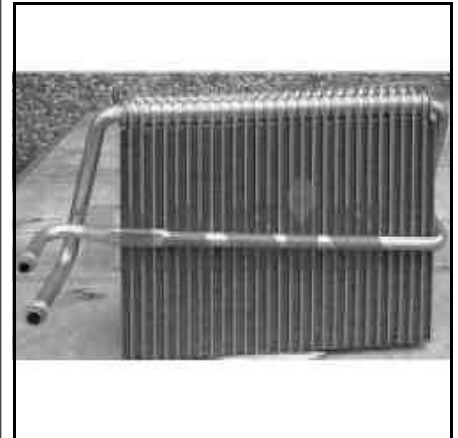

**11 831 058 EVAPORATOR**

W 220

**Mercedes Benz**  
220 830 10 58

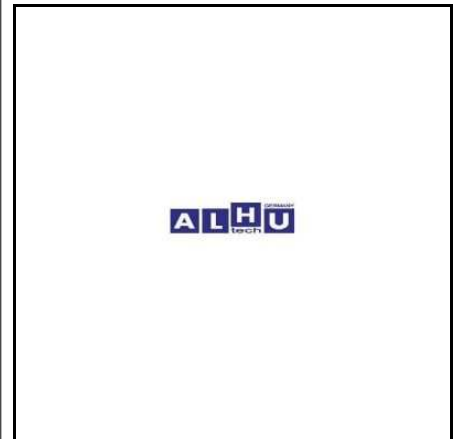

Motor / Engine

**11 500 049 EXPANSION TANK**

W220 W463

**Mercedes Benz**  
220 500 00 49



**11 500 051 EXPANSION TANK**

**Mercedes Benz**  
221 500 03 49

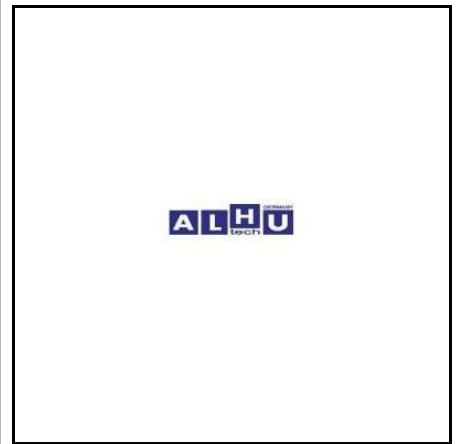

**11 500 249 EXPANSION TANK**

W201 W461 W463

**Mercedes Benz**  
202 500 02 49



**11 500 349 EXPANSION TANK**

**Mercedes Benz**  
124 500 13 49





Motor / Engine

**11 500 549 EXPANSION TANK**

**Mercedes Benz**  
126 500 15 49



**11 500 646 EXPANSION TANK**

W202

**Mercedes Benz**  
202 500 06 49



**11 500 749 EXPANSION TANK**

**Mercedes Benz**  
124 500 17 49



**11 500 849 EXPANSION TANK**

W203

**Mercedes Benz**  
203 500 00 49

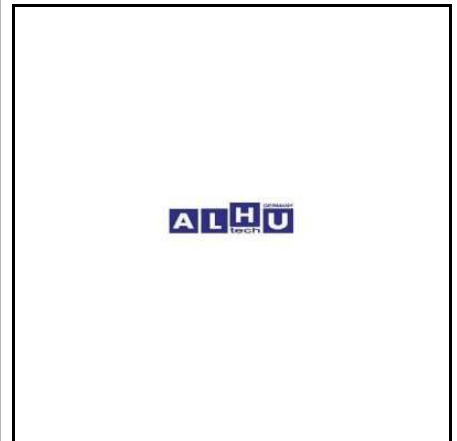

Motor / Engine

**11 501 349 EXPANSION TANK**

W163

**Mercedes Benz**  
163 500 03 49



**11 501 549 EXPANSION TANK**

W210

**Mercedes Benz**  
210 500 05 49



**11 501 749 EXPANSION TANK**

**Mercedes Benz**  
140 500 17 49



**11 501 949 EXPANSION TANK**

W211

**Mercedes Benz**  
211 500 00 49



Motor / Engine

**63 451 439 EXPANSION TANK**

**new**

**Mercedes Benz**  
204 500 05 49



**11 830 001 EXPANSION VALVE**

W 203 W 204 W 212

**Mercedes Benz**  
230 830 01 84



**11 830 002 EXPANSION VALVE**

W 210

**Mercedes Benz**  
202 830 01 84



**11 830 003 EXPANSION VALVE**

W 140

**Mercedes Benz**  
140 830 04 84



Motor / Engine

**11 830 008 EXPANSION VALVE**

**Mercedes Benz**  
220 830 03 84

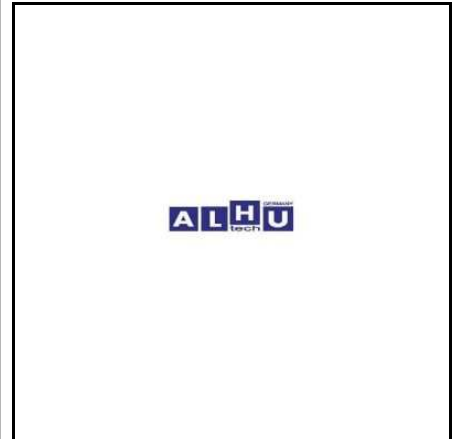

**11 830 009 EXPANSION VALVE**

W 126

**Mercedes Benz**  
126 830 03 84



**11 830 017 EXPANSION VALVE**

**Mercedes Benz**  
164 830 00 84



**11 200 523 FAN BLADE**

**Mercedes Benz**  
603 200 05 23

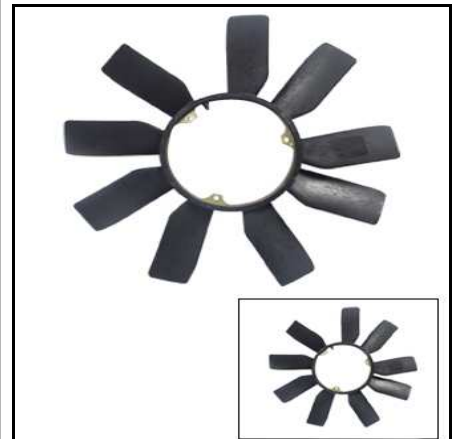

Motor / Engine

**11 202 423 FAN BLADE**

**Mercedes Benz**  
601 200 04 23



**11 205 306 FAN BLADE**

**Mercedes Benz**  
003 205 03 06



**11 200 023 FAN BLADE**

**Mercedes Benz**  
111 200 00 23

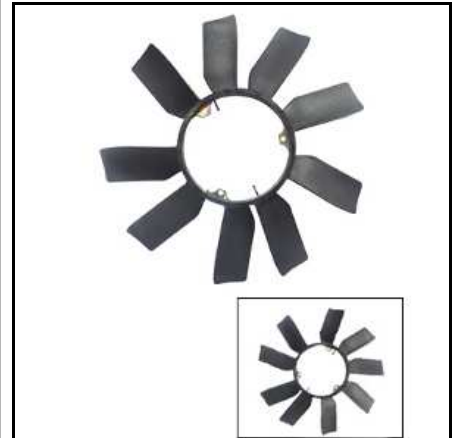

**11 200 123 FAN BLADE**

**Mercedes Benz**  
604 200 01 23



Motor / Engine

**11 200 323 FAN BLADE**

**Mercedes Benz**  
601 200 03 23



**11 200 423 FAN BLADE**

**Mercedes Benz**  
603 200 04 23

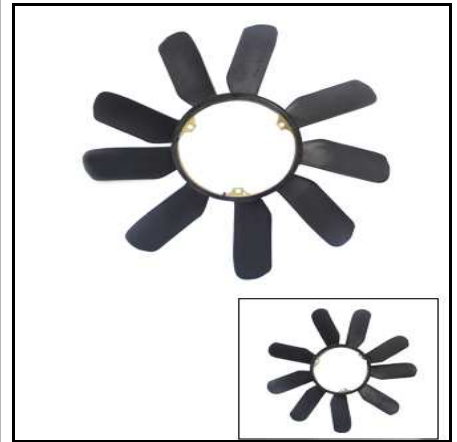

**11 200 623 FAN BLADE**

**Mercedes Benz**  
103 200 06 23



**11 200 723 FAN BLADE**

**Mercedes Benz**  
102 200 20 23



Motor / Engine

11 201 123 FAN BLADE

**Mercedes Benz**  
102 200 21 23



11 201 423 FAN BLADE

**Mercedes Benz**  
602 200 04 23



11 202 123 FAN BLADE

**Mercedes Benz**  
110 200 01 23



11 203 423 FAN BLADE

**Mercedes Benz**  
103 200 03 23  
103 200 04 23



Motor / Engine

**11 205 316 FAN BLADE**

**Mercedes Benz**  
003 205 13 06



**11 205 406 FAN BLADE**

**Mercedes Benz**  
115 205 03 06  
115 205 04 06



**11 200 180 FAN BRACKET**

**Mercedes Benz**  
103 200 17 28

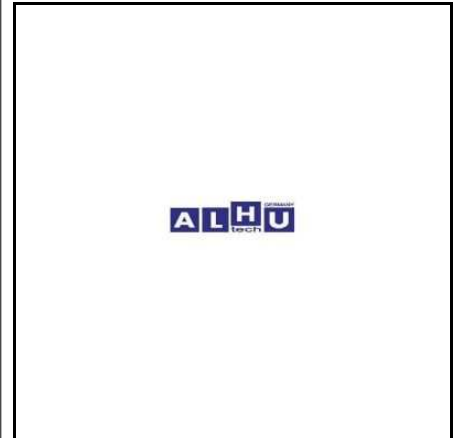

**11 200 280 FAN BRACKET**

**Mercedes Benz**  
104 200 15 28

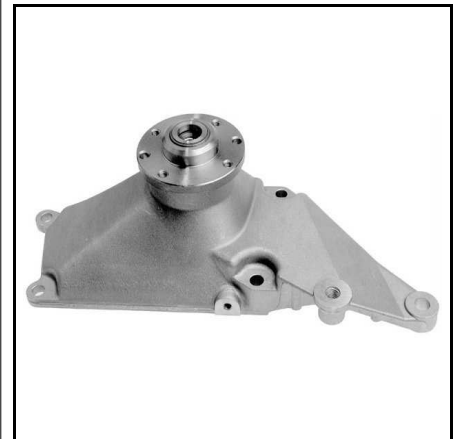



Motor / Engine

**11 200 001 FAN CLUTCH**

**Mercedes Benz**  
120 200 01 22

**Behr/Hella**  
8MV 376 733-061

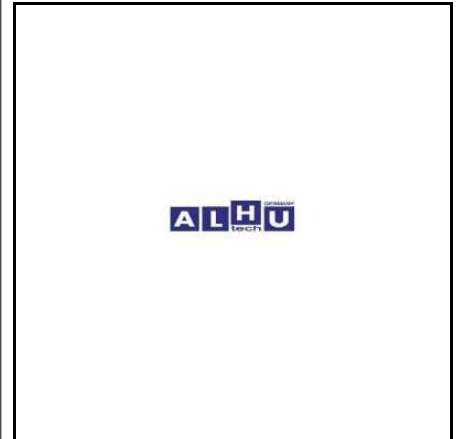

**11 200 002 FAN CLUTCH**

**Mercedes Benz**  
603 200 00 22



**11 200 022 FAN CLUTCH**

**Mercedes Benz**  
111 200 04 22



**11 200 028 FAN CLUTCH**

**Mercedes Benz**  
000 200 59 22

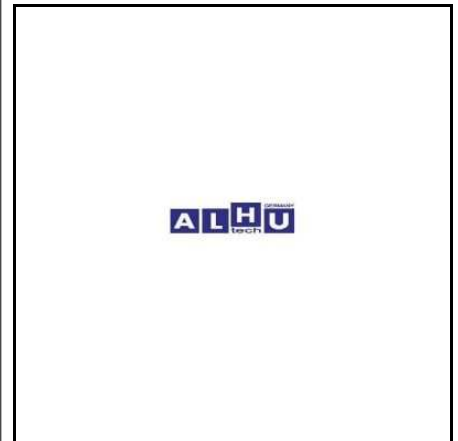

Motor / Engine

**11 200 033 FAN CLUTCH**

**Mercedes Benz**  
606 200 01 22



**11 200 034 FAN CLUTCH**

**Mercedes Benz**  
613 200 00 22



**11 200 035 FAN CLUTCH**

**Mercedes Benz**  
116 200 06 22

**Behr/Hella**  
8MV 376 732-141



**11 200 036 FAN CLUTCH**

**Mercedes Benz**  
000 200 39 22

**Behr/Hella**  
8MV 376 732-431



Motor / Engine

**11 200 122 FAN CLUTCH**

**Mercedes Benz**  
112 200 01 22

**ZF Trading GmbH**  
2100 030 031



**11 200 142 FAN CLUTCH**

**Mercedes Benz**  
000 200 04 22



**11 200 422 FAN CLUTCH**

**Mercedes Benz**  
103 200 04 22



**11 200 622 FAN CLUTCH**

**Mercedes Benz**  
103 200 06 22



Motor / Engine

**11 200 722 FAN CLUTCH**

SPRINTER

**Mercedes Benz**  
000 200 37 22

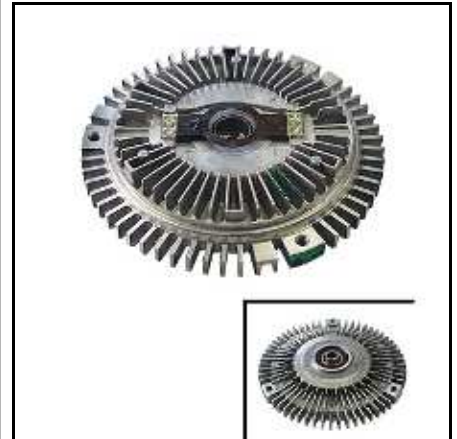

**11 200 822 FAN CLUTCH**

**Mercedes Benz**  
116 200 08 22  
116 200 11 22



**11 200 922 FAN CLUTCH**

**Mercedes Benz**  
119 200 00 22



**11 201 522 FAN CLUTCH**

**Mercedes Benz**  
603 200 05 22



Motor / Engine

**11 201 822 FAN CLUTCH**

SPRINTER

**Mercedes Benz**  
000 200 58 22

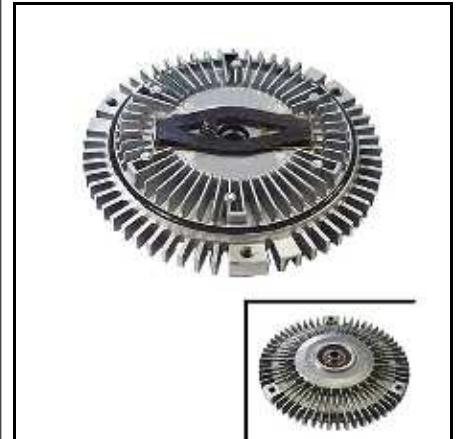

**11 202 022 FAN CLUTCH**

**Mercedes Benz**  
604 200 00 22



**11 202 122 FAN CLUTCH**

**Mercedes Benz**  
116 200 05 22

**Behr/Hella**  
8MV 376 733-051



**11 202 222 FAN CLUTCH**

**Mercedes Benz**  
112 200 02 22

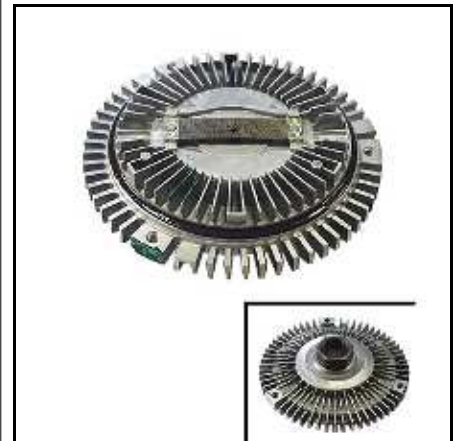

Motor / Engine

**11 202 522 FAN CLUTCH**

**Mercedes Benz**  
111 200 05 22



**11 202 822 FAN CLUTCH**

**Mercedes Benz**  
000 200 38 22



**11 203 122 FAN CLUTCH**

**Mercedes Benz**  
113 200 01 22



**11 203 222 FAN CLUTCH**

**Mercedes Benz**  
119 200 02 22



Motor / Engine

**11 203 322 FAN CLUTCH**

**Mercedes Benz**  
616 200 03 22



**11 203 622 FAN CLUTCH**

**Mercedes Benz**  
603 200 06 22



**11 203 822 FAN CLUTCH**

**Mercedes Benz**  
103 200 09 22  
103 200 11 22

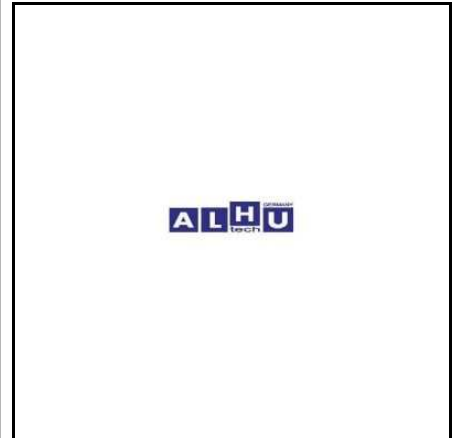

**11 204 122 FAN CLUTCH**

**Mercedes Benz**  
602 200 01 22



Motor / Engine

**11 206 122 FAN CLUTCH**

SPRINTER

**Mercedes Benz**  
000 200 51 22



**18 200 122 FAN CLUTCH**

**Mercedes Benz**  
119 200 01 22

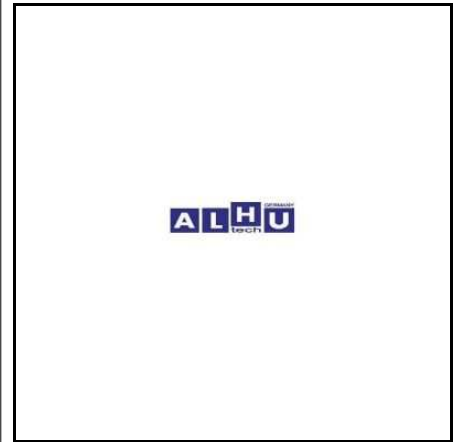

**11 501 355 FAN SHROUD**



W202

**Mercedes Benz**  
202 505 21 55

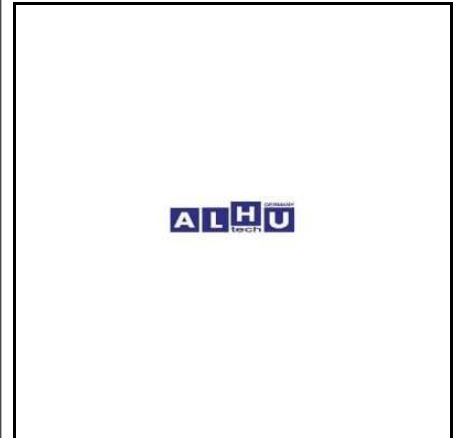

**11 078 489 FUEL PRESSURE REGULATOR**

**Mercedes Benz**  
000 078 15 89  
000 078 18 89

**Bosch**  
0 280 160 587





Motor / Engine

10 000 000 FUEL PUMP

**Mercedes Benz**  
002 091 97 01

**Bosch**  
0 580 254 910

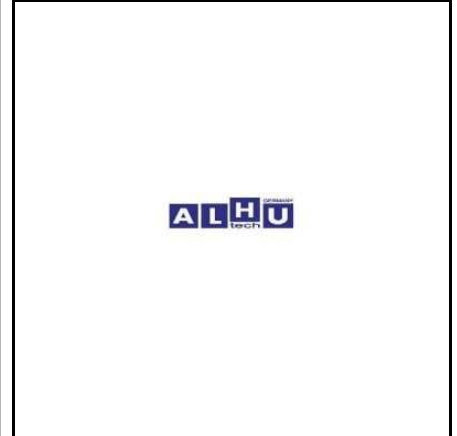

11 500 155 GUARD, FAN SHROUD

W124

**Mercedes Benz**  
124 505 01 55



11 500 355 GUARD, FAN SHROUD

W140

**Mercedes Benz**  
140 500 03 55



11 500 655 GUARD, FAN SHROUD

**Mercedes Benz**  
124 500 06 55

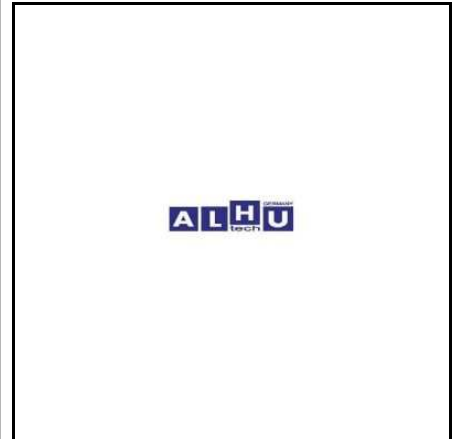

Motor / Engine

**11 500 755**    **GUARD, FAN SHROUD**

W124

**Mercedes Benz**  
124 500 07 55



**12 018 182**    **HOSE, CRANKSHAFT BREATHER**

M 112 M 113

**Mercedes Benz**  
112 018 01 82



**12 018 282**    **HOSE, CRANKSHAFT BREATHER**

M 112 M 113

**Mercedes Benz**  
112 018 02 82



**12 018 382**    **HOSE, CRANKSHAFT BREATHER**

M 112 M 113

**Mercedes Benz**  
112 018 03 82



Motor / Engine

**12 018 482 HOSE, CRANKSHAFT BREATHER**

**Mercedes Benz**  
112 018 04 82

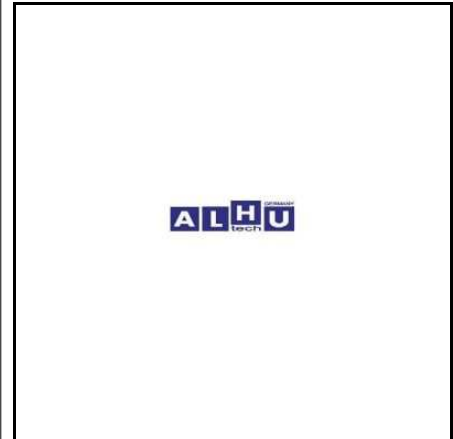

**11 130 460 IDLER PULLEY**

**Mercedes Benz**  
116 130 04 60

**LMI**  
1081101



**12 018 302 OIL CAP**

**Mercedes Benz**  
000 010 02 85  
000 018 07 02  
111 018 03 02



**11 010 013 OIL PAN**

**Mercedes Benz**  
104 014 15 02

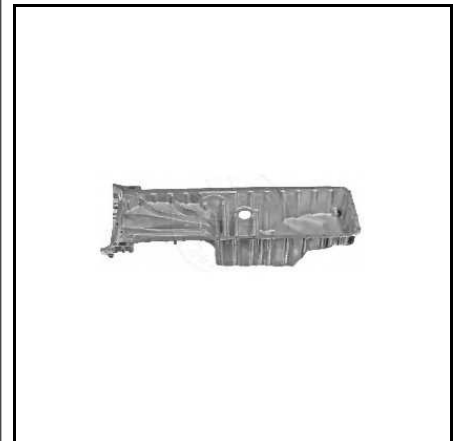

Motor / Engine

**11 010 213 OIL PAN**

**Mercedes Benz**  
102 010 42 13

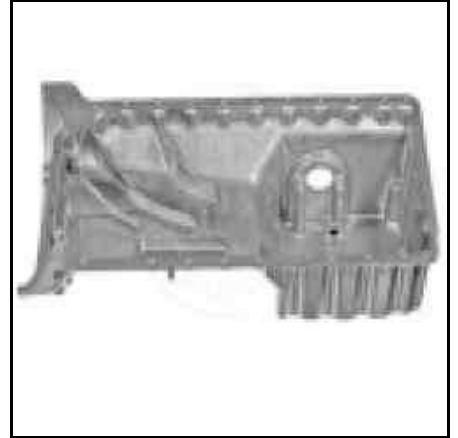

**11 010 513 OIL PAN**

**Mercedes Benz**  
103 010 05 13

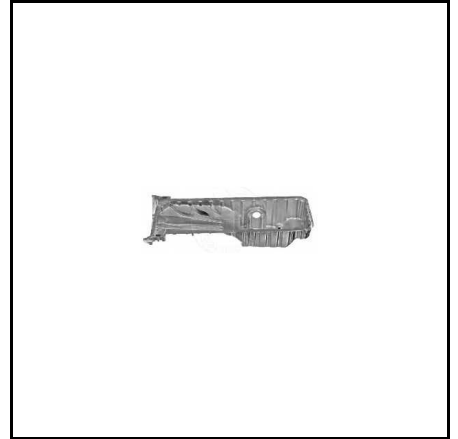

**11 010 628 OIL PAN**

**Mercedes Benz**  
112 010 06 28



**11 200 007 PULLEY**

**Mercedes Benz**  
611 155 07 15



**Motor / Engine**

**11 200 025 PULLEY**

**Mercedes Benz**  
604 150 06 60



**11 200 026 PULLEY**

**Mercedes Benz**  
611 155 04 15



**11 500 003 RADIATOR**

**Mercedes Benz**  
201 500 29 03

**Behr/Hella**  
8MK 376 711-331  
8MK 376 714-551



**11 500 103 RADIATOR**

W124

**Mercedes Benz**  
124 500 98 03

**Behr/Hella**  
8MK 376 712-461



Motor / Engine

**11 500 203 RADIATOR**

W124

**Mercedes Benz**  
124 500 90 03

**Behr/Hella**  
8MK 376 712-421

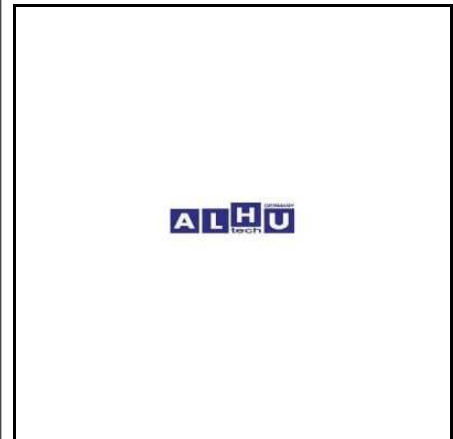

**11 500 303 RADIATOR**

W126

**Mercedes Benz**  
126 500 51 03

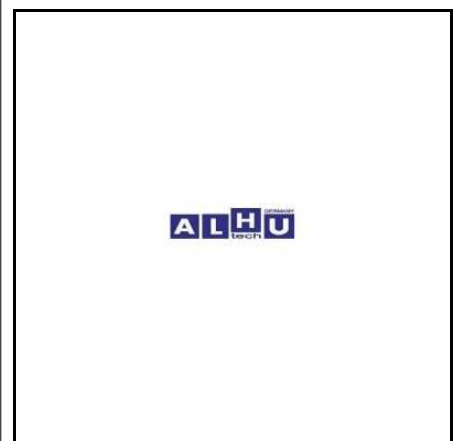

**11 500 403 RADIATOR**

W126

**Mercedes Benz**  
126 500 48 03

**Behr/Hella**  
8MK 376 712-521

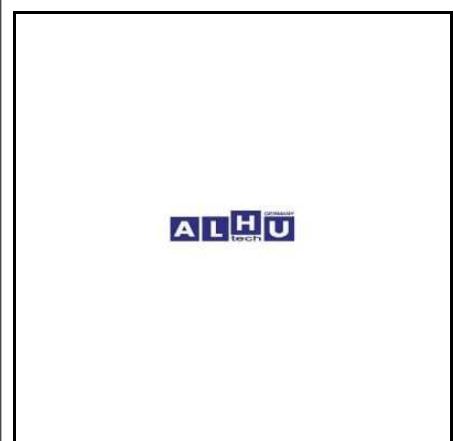

**11 500 503 RADIATOR**

W140

**Mercedes Benz**  
140 500 21 03

**Behr/Hella**  
8MK 376 712-201

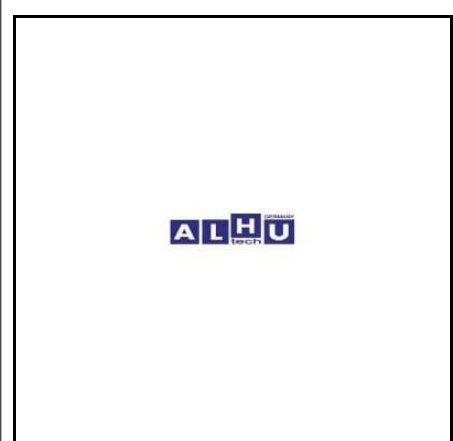

Motor / Engine

**11 500 603 RADIATOR**

**Mercedes Benz**  
201 500 46 03

**Behr/Hella**  
8MK 376 711-311



**11 500 006 RADIATOR CAP**

W163

**Mercedes Benz**  
163 500 00 06



**12 018 304 RADIATOR CAP**

W203 W204 W211

**Mercedes Benz**  
210 501 07 15



**11 500 010 RADIATOR HOSE**

**Mercedes Benz**  
220 501 00 82



Motor / Engine

**18 501 002 RADIATOR HOSE**

**Mercedes Benz**  
104 203 04 82

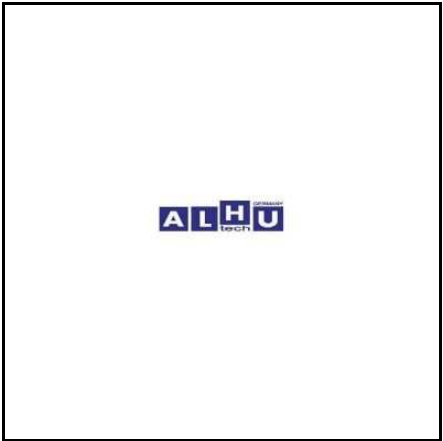

**18 501 003 RADIATOR HOSE**

W220

**Mercedes Benz**  
220 501 03 82



**18 501 004 RADIATOR HOSE**

W220

**Mercedes Benz**  
220 501 04 82

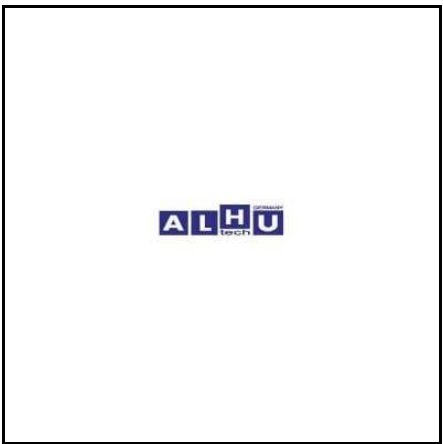

**11 200 014 SHOCK ABSORBER**

W 202 W 203 W 210

**Mercedes Benz**  
112 200 00 14

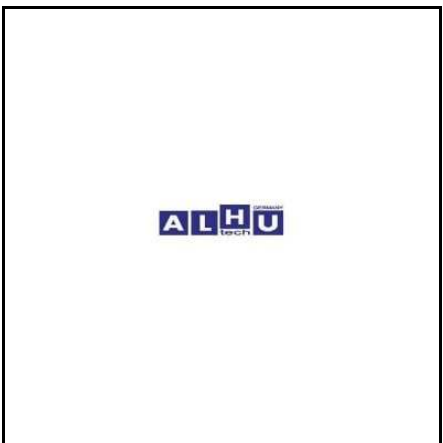



Motor / Engine

**11 200 114 SHOCK ABSORBER**

**Mercedes Benz**  
103 200 01 14



**11 200 414 SHOCK ABSORBER**

**Mercedes Benz**  
102 200 14 14



**11 200 514 SHOCK ABSORBER**

W 202 W 203 W 210

**Mercedes Benz**  
111 200 04 14



**11 203 160 SLIDING RAIL**

M 102

**Mercedes Benz**  
102 052 03 16



Motor / Engine

**11 203 260 SLIDING RAIL**

M 102

**Mercedes Benz**  
102 052 04 16

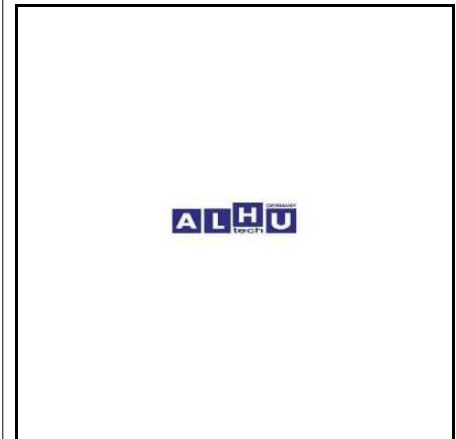

**11 540 253 SPACER**

**Mercedes Benz**  
203 540 00 53  
203 540 01 53  
203 540 02 53

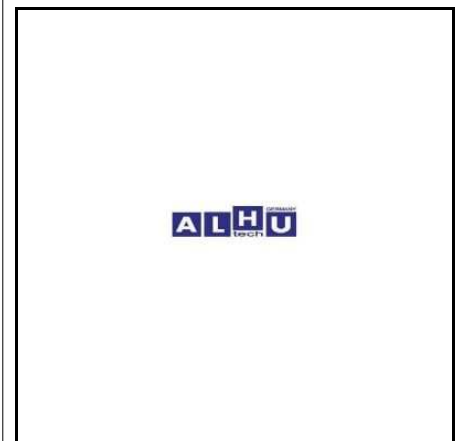

**11 156 110 SPARK PLUG ADAPTOR**

**Mercedes Benz**  
000 156 72 10  
000 156 75 10

**Bosch**  
0 356 150 022

**BERU**  
ZLE 245

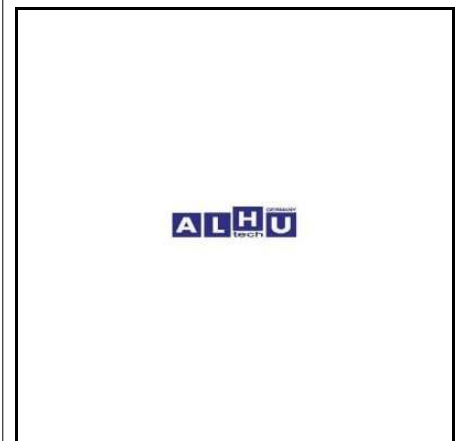

**11 156 142 SPARK PLUG ADAPTOR**

M 119

**Mercedes Benz**  
000 159 41 42

**BERU**  
ZLE 247

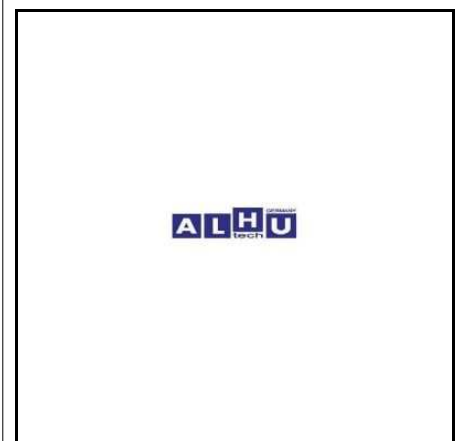

Motor / Engine

**11 156 510 SPARK PLUG ADAPTOR**

**Mercedes Benz**  
000 156 66 10

**BERU**  
ZLE 227  
0 300 362 106



**11 156 642 SPARK PLUG ADAPTOR**

M 104 M 111

**Mercedes Benz**  
000 159 35 42  
000 159 36 42

**Bosch**  
0 356 100 100

**BERU**  
ZLE 234

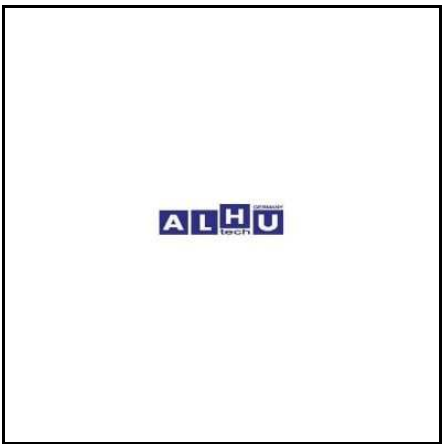

**11 156 710 SPARK PLUG ADAPTOR**

**Mercedes Benz**  
000 156 57 10

**BERU**  
ZLE 135

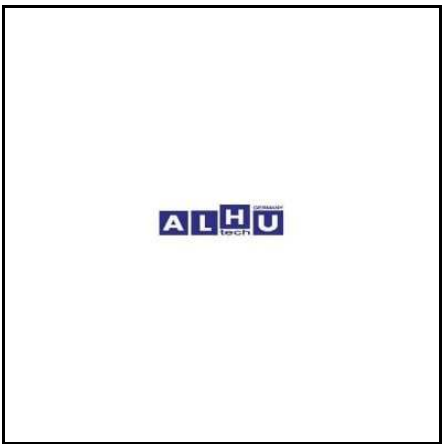

**11 156 810 SPARK PLUG ADAPTOR**

**Mercedes Benz**  
000 156 67 10  
000 156 68 10

**BERU**  
ZLE 225

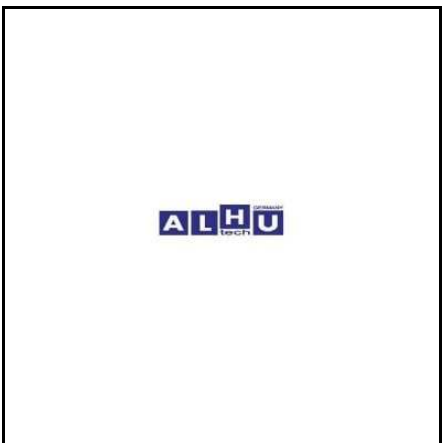

Motor / Engine

**18 158 001 SUPRESSOR HOUSING**

**Mercedes Benz**  
103 158 05 85

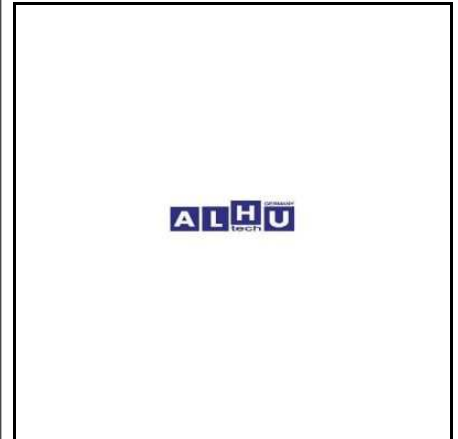

**18 158 002 SUPRESSOR HOUSING**

**Mercedes Benz**  
103 158 06 85

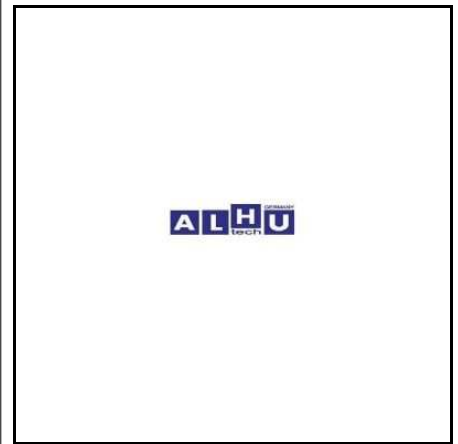

**18 200 236 TENSIONER LEVER**

M 103

**Mercedes Benz**  
103 200 02 36

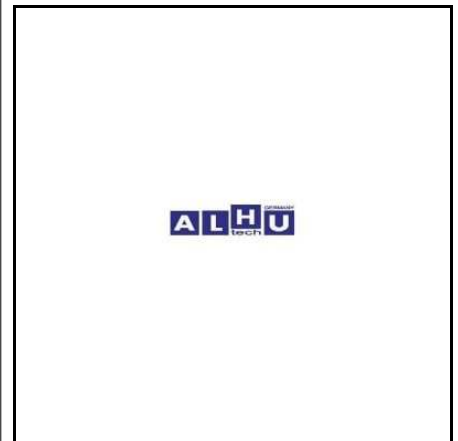

**11 140 260 THERMO VALVE BLACK**

**Mercedes Benz**  
001 140 62 60



Motor / Engine

**11 140 160 THERMO VALVE ( RED )**

**Mercedes Benz**  
000 140 71 60



**11 140 760 THERMO VALVE ( WHITE )**

**Mercedes Benz**  
001 140 07 60



**11 140 560 THERMO VALVE (GREEN)**

**Mercedes Benz**  
001 140 52 60



**11 203 002 THERMOSTAT**

87 degree

**Mercedes Benz**  
110 200 05 15

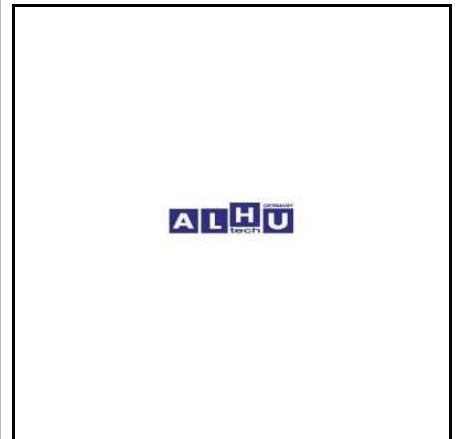

Motor / Engine

**11 203 003 THERMOSTAT**

85 degree

**Mercedes Benz**

601 200 00 15

**TA501**

2.136.85

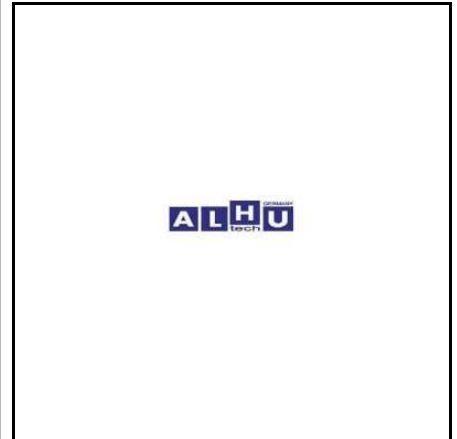

**11 200 015 THERMOSTAT HOUSING**

W 124 W 202 W 210

**Mercedes Benz**

111 200 04 15

111 200 09 15



**11 200 115 THERMOSTAT HOUSING**

W 202 W 210

**Mercedes Benz**

111 200 03 15



**11 200 417 THERMOSTAT HOUSING**

M 124 M 201

**Mercedes Benz**

102 200 04 17



Motor / Engine

**21 200 215 THERMOSTAT HOUSING**

**Mercedes Benz**

611 200 02 15  
611 200 07 15

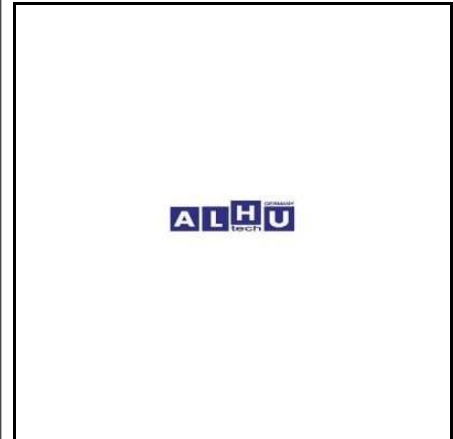

**11 200 515 THERMOSTAT HOUSING, complete**

**Mercedes Benz**

102 200 15 15



**11 200 315 THERMOSTAT with housing**

W 210

**Mercedes Benz**

611 200 03 15  
611 200 05 15

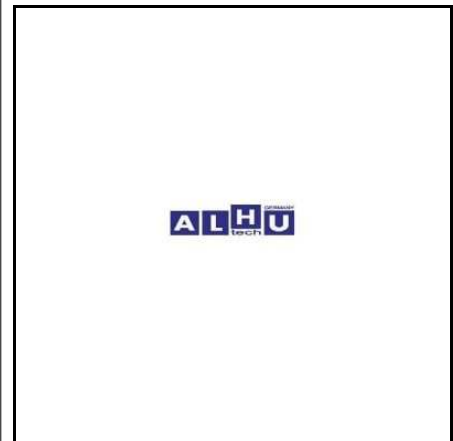

**11 145 365 VACUUM PUMP**

**Mercedes Benz**

000 230 43 65

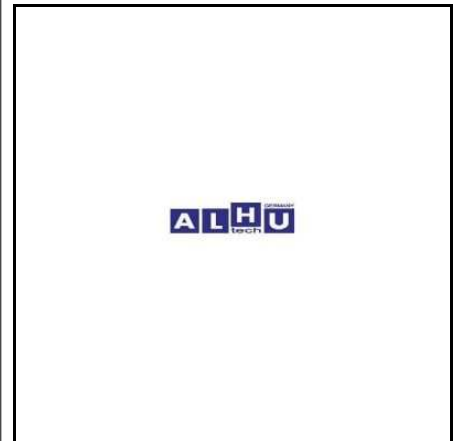

Motor / Engine

**11 145 565 VACUUM PUMP**

**Mercedes Benz**  
000 230 35 65



**11 145 665 VACUUM PUMP**

**Mercedes Benz**  
000 230 36 65  
000 230 38 65



**18 230 001 VACUUM PUMP**

**Mercedes Benz**  
000 230 31 65



**11 200 072 WATER PUMP**

**Mercedes Benz**  
617 200 07 20

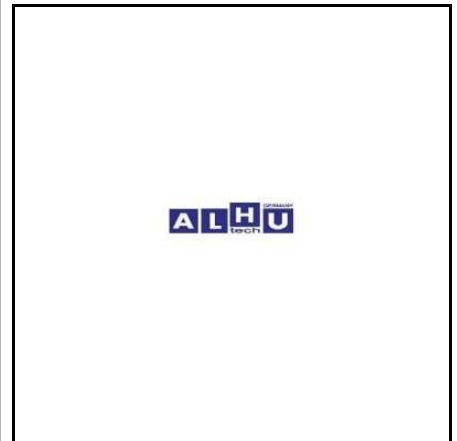



Motor / Engine

**18 200 001 WATER PUMP**

**Mercedes Benz**  
102 200 42 01

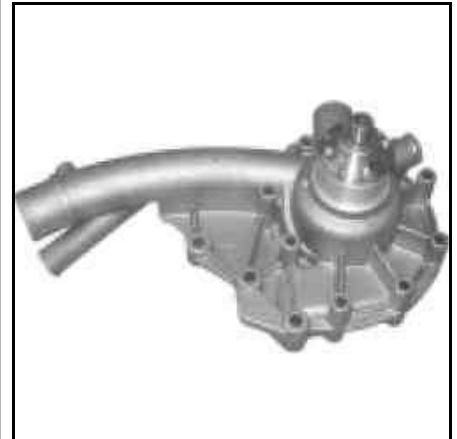

**18 200 002 WATER PUMP**

**Mercedes Benz**  
102 200 50 01



**18 200 003 WATER PUMP**

**Mercedes Benz**  
103 200 37 01



**18 200 004 WATER PUMP**

**Mercedes Benz**  
104 200 31 01



Motor / Engine

**18 200 005 WATER PUMP**

**Mercedes Benz**  
104 200 49 01



**18 200 006 WATER PUMP**

**Mercedes Benz**  
110 200 17 20



**18 200 007 WATER PUMP**

**Mercedes Benz**  
111 200 23 01

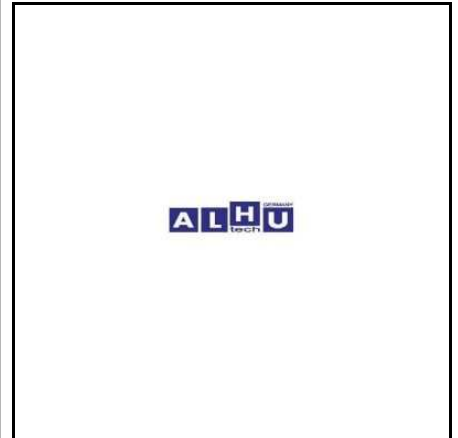

**18 200 008 WATER PUMP**

**Mercedes Benz**  
102 200 43 01

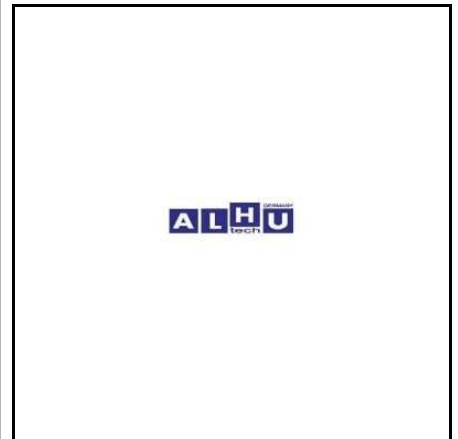

Motor / Engine

**18 200 009 WATER PUMP**

**Mercedes Benz**  
111 200 42 01

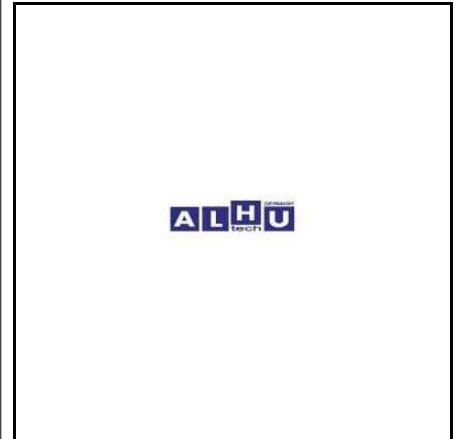

**18 200 010 WATER PUMP**

**Mercedes Benz**  
112 200 14 01

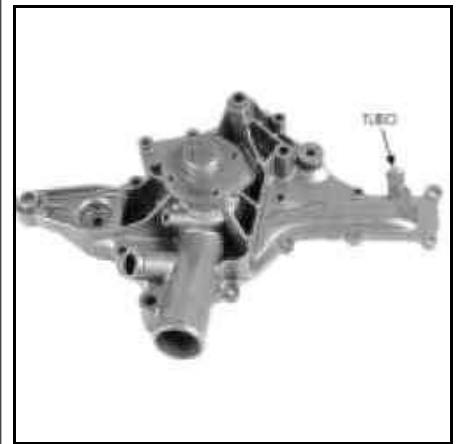

**18 200 013 WATER PUMP**

**Mercedes Benz**  
117 200 33 01



**18 200 014 WATER PUMP**

M 119

**Mercedes Benz**  
119 200 04 01  
119 200 09 01  
119 200 15 01



Motor / Engine

**18 200 015 WATER PUMP**

**Mercedes Benz**  
119 200 21 01



**18 200 016 WATER PUMP**

**Mercedes Benz**  
271 200 02 01



**18 200 017 WATER PUMP**

**Mercedes Benz**  
601 200 09 20

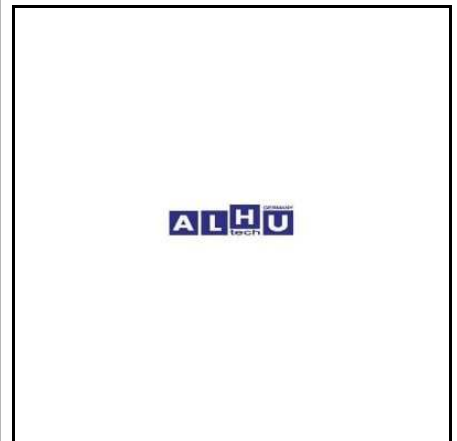

**18 200 019 WATER PUMP**

**Mercedes Benz**  
120 200 11 01

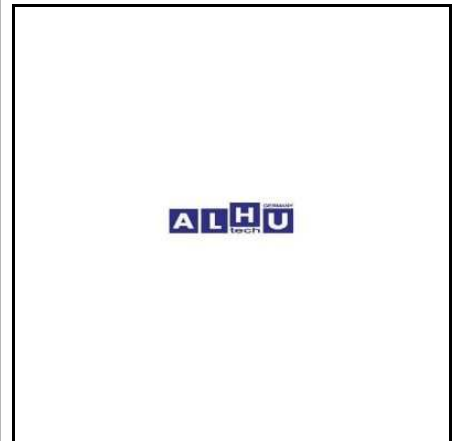

Motor / Engine

**18 200 020 WATER PUMP**

**Mercedes Benz**  
104 200 30 01

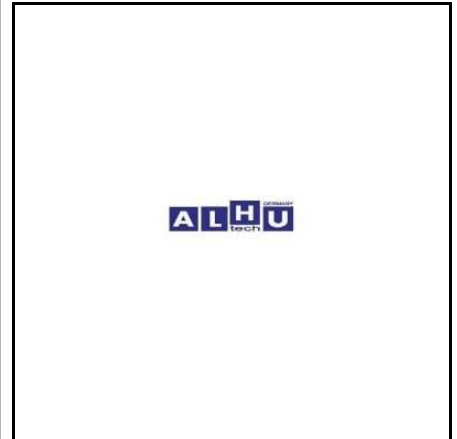

**18 200 021 WATER PUMP**

**Mercedes Benz**  
104 200 32 01



**18 200 029 WATER PUMP**

**Mercedes Benz**  
104 200 33 01  
104 200 47 01

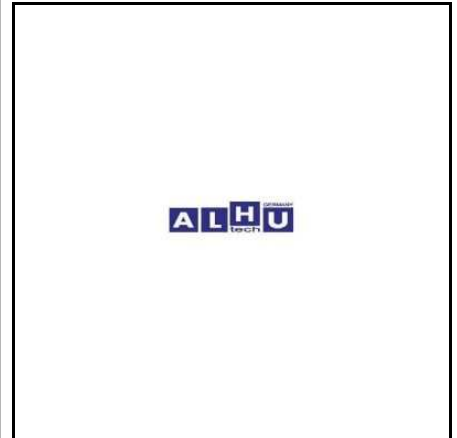

**18 200 040 WATER PUMP**

**Mercedes Benz**  
103 200 05 01  
103 200 38 01



Motor / Engine

**18 200 042 WATER PUMP**

**Mercedes Benz**  
104 200 29 01



**18 200 043 WATER PUMP**

**Mercedes Benz**  
104 200 44 01

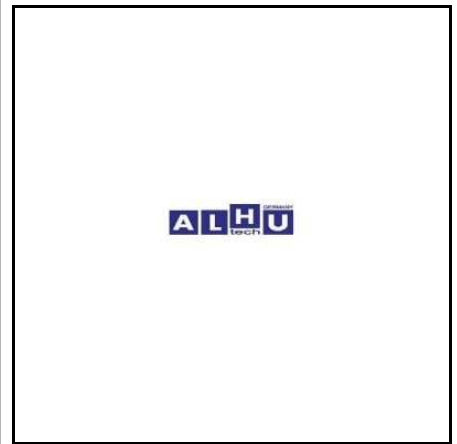

**18 200 047 WATER PUMP**

**Mercedes Benz**  
110 200 19 20



**18 200 055 WATER PUMP**

**Mercedes Benz**  
111 200 22 01

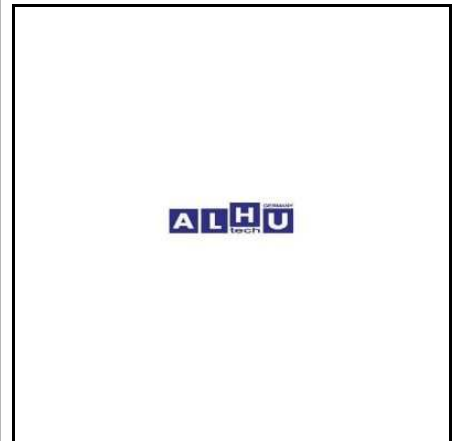

Motor / Engine

**18 200 056 WATER PUMP**

**Mercedes Benz**  
166 200 07 20



**18 200 057 WATER PUMP**

**Mercedes Benz**  
611 200 10 01



**18 200 058 WATER PUMP**

**Mercedes Benz**  
611 200 11 01



**18 200 059 WATER PUMP**

**Mercedes Benz**  
646 200 03 01



Motor / Engine

**18 201 120 WATER PUMP**

**Mercedes Benz**  
611 200 12 01



**18 200 430 WATER PUMP**

**Mercedes Benz**  
111 200 43 01



**18 200 801 WATER PUMP**

**Mercedes Benz**  
111 200 38 01



**18 200 901 WATER PUMP**

**Mercedes Benz**  
111 200 39 01





Schalter / Switch

**15 821 710 A/C SWITCH**

W 126 W 201 W 202

**Mercedes Benz**  
004 820 07 10  
004 820 68 10

**Behr/Hella**  
6ZL 351 024-081



**15 823 310 A/C SWITCH**

W 124 W 126 W 201

**Mercedes Benz**  
124 820 83 10

**Behr/Hella**  
6ZL 351 022-011



**11 821 551 BLOWER REGULATOR**

W210

**Mercedes Benz**  
210 821 15 51



**11 821 651 BLOWER REGULATOR**

W210

**Mercedes Benz**  
210 821 16 51



Schalter / Switch

**15 820 711 BLOWER REGULATOR**

W124

**Mercedes Benz**  
124 820 27 10



**15 821 251 BLOWER REGULATOR**

W124

**Mercedes Benz**  
124 821 21 51



**18 210 251 BLOWER REGULATOR**

W202

**Mercedes Benz**  
202 820 25 10

**Behr/Hella**  
5HL 351 321-101



**18 210 351 BLOWER REGULATOR**

W140

**Mercedes Benz**  
140 821 83 51



Schalter / Switch

**18 210 921 BLOWER REGULATOR**

W203 W220 W221

**Mercedes Benz**  
220 820 92 10

**Behr/Hella**  
5HL 351 321-241



**18 820 210 BLOWER REGULATOR**

W202 W210

**Mercedes Benz**  
210 820 62 10

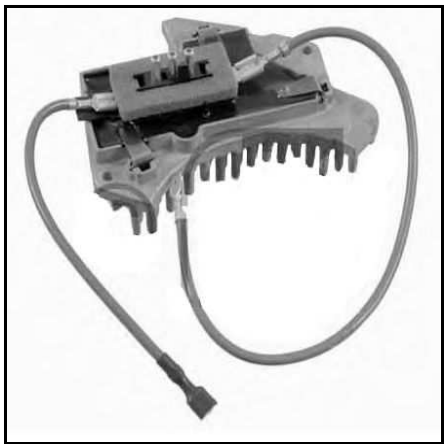

**15 545 009 BRAKE LIGHT SWITCH**

W202 W210

**Mercedes Benz**  
001 545 31 09  
001 545 64 09



**15 545 709 BRAKE LIGHT SWITCH**

W201 W202 W210

**Mercedes Benz**  
001 545 20 09



Schalter / Switch

**19 545 001 BRAKE LIGHT SWITCH**

**Mercedes Benz**  
001 545 21 09

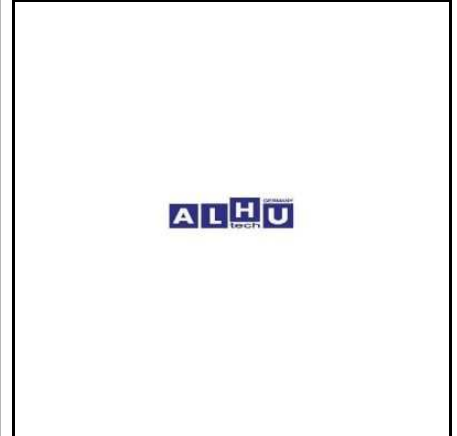

**11 830 010 CONDENSER FAN SWITCH**

**Mercedes Benz**  
000 820 80 10



**11 542 517 COOLANT SWITCH ( LIGHT BLUE )**

W124 W126 W140

**Mercedes Benz**  
008 542 45 17



**15 820 010 HAZARD LAMP SWITCH**

W123 W126 W201

**Mercedes Benz**  
000 820 90 10



Schalter / Switch

**15 820 110 HAZARD LAMP SWITCH**

W124W201 W202

**Mercedes Benz**  
124 820 01 10

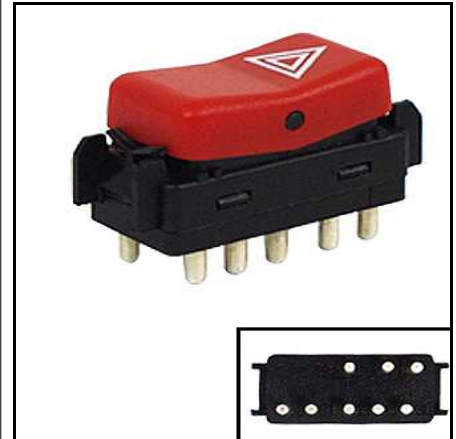

**15 821 451 HAZARD LAMP SWITCH**

**Mercedes Benz**  
140 821 64 51

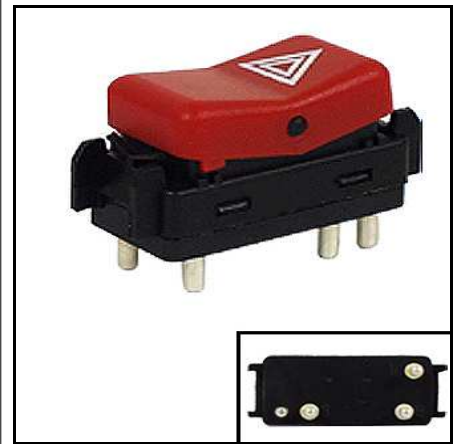

**11 542 817 OIL LEVEL SENSOR**

**Mercedes Benz**  
126 542 08 17



**11 542 170 OIL PRESSURE SWITCH**

W140

**Mercedes Benz**  
009 542 08 17



Schalter / Switch

**11 542 417 OIL PRESSURE SWITCH**

W124 W201 W210

**Mercedes Benz**  
006 542 94 17



**15 540 645 RELAY**

**Mercedes Benz**  
000 540 67 45

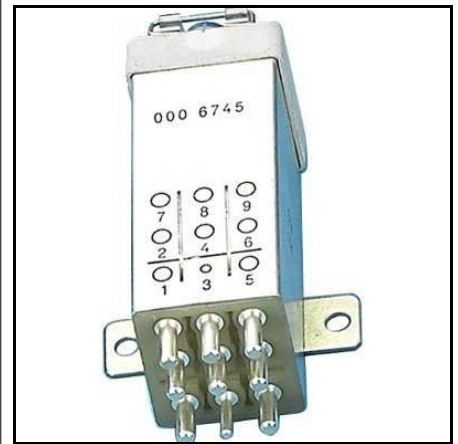

**15 540 745 RELAY**

**Mercedes Benz**  
201 540 37 45



**15 545 005 RELAY**

**Mercedes Benz**  
003 545 25 05



Schalter / Switch

**15 545 014 REVERSE LIGHT SWITCH**

W124 W201

**Mercedes Benz**

140 545 04 14  
201 545 00 14



**29 545 114 REVERSE LIGHT SWITCH**

W210 W202

**Mercedes Benz**

202 545 01 14

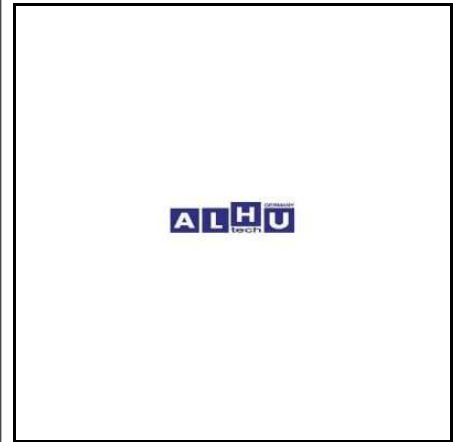

**11 542 017 SENDER OIL UNIT**

W140 W210

**Mercedes Benz**

124 542 00 17



**15 830 572 SENDER UNIT**

interior temperature

**Mercedes Benz**

140 830 01 72



Schalter / Switch

**15 830 772 SENDER UNIT**

**Mercedes Benz**  
210 830 05 72  
210 830 07 72



**11 545 124 SENDER UNIT100 (BLACK)**

**Mercedes Benz**  
006 545 91 24



**11 540 024 SENSOR, COOLANT LEVEL**

W202 W210 W140

**Mercedes Benz**  
210 545 00 24



**11 540 244 SENSOR, COOLANT LEVEL**

W124 W126 W201

**Mercedes Benz**  
124 540 02 44





Schalter / Switch

**11 540 324    SENSOR, COOLANT LEVEL**

W140 W202 W210

**Mercedes Benz**  
129 545 02 24



**11 540 524    SENSOR, COOLANT LEVEL**

W124 W201 W202

**Mercedes Benz**  
210 540 00 45



**11 540 624    SENSOR, COOLANT LEVEL**

W124 W140 W201

**Mercedes Benz**  
140 540 00 17



**11 542 418    SENSOR, OUTER TEMPERATURE**

**Mercedes Benz**  
000 542 84 18

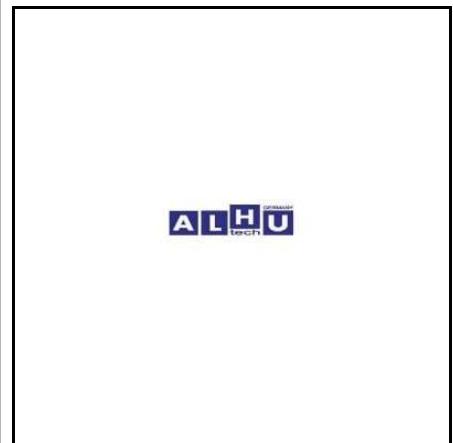

Schalter / Switch

**15 226 044 STEERING COLUMN SWITCH**

W210

**Mercedes Benz**  
210 540 01 44



**15 226 144 STEERING COLUMN SWITCH**

W202

**Mercedes Benz**  
202 540 21 44



**15 226 146 STEERING COLUMN SWITCH**

W210

**Mercedes Benz**  
208 545 00 10



**15 226 244 STEERING COLUMN SWITCH**

W124

**Mercedes Benz**  
124 540 20 44



Schalter / Switch

**15 226 445 STEERING COLUMN SWITCH**

SPRINTER

**Mercedes Benz**  
000 540 74 45  
001 540 46 45

**VW**  
2D0 953 503



**15 226 544 STEERING COLUMN SWITCH**

W116 W123 W460

**Mercedes Benz**  
004 545 67 24  
005 545 41 24



**15 227 144 STEERING COLUMN SWITCH**

W220

**Mercedes Benz**  
220 545 00 10



**15 821 910 SWITCH, CENTRAL DOOR LOCK**

**Mercedes Benz**  
202 820 39 10  
202 820 40 10



Schalter / Switch

**15 821 310 SWITCH, DOOR LOCK**

**Mercedes Benz**  
140 820 63 10



**11 543 117 TEMPERATURE SENSOR**

**Mercedes Benz**  
011 542 51 17

**VW**  
2D0 919 369



**11 545 224 THERMO SWITCH**

W124 W201

**Mercedes Benz**  
006 545 42 24



**11 545 424 THERMO SWITCH 100 degrees/grey**

W124 W126 W201

**Mercedes Benz**  
006 545 14 24



Schalter / Switch

**11 545 524 THERMO SWITCH 100/95 (RED)**

W124 W126 W201

**Mercedes Benz**  
006 545 15 24

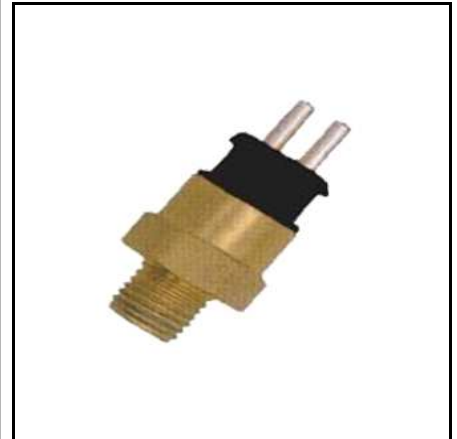

**11 545 724 THERMO SWITCH 110 degree**

black

**Mercedes Benz**  
006 545 37 24



**11 545 525 THERMO SWITCH 85 degree**

W124 W126 W201

**Mercedes Benz**  
006 545 15 24



**11 542 217 WATER TEMPERATURE SENSOR**

black

**Mercedes Benz**  
008 542 32 17

**BERU**  
TF 002



Schalter / Switch

**11 542 617 WATER TEMPERATURE SENSOR**

W124 W126 W140

**Mercedes Benz**  
005 542 26 17

**BERU**  
TF 001



**11 543 317 WATER TEMPERATURE SENSOR**

W168 W203 W204

**Mercedes Benz**  
000 542 51 18

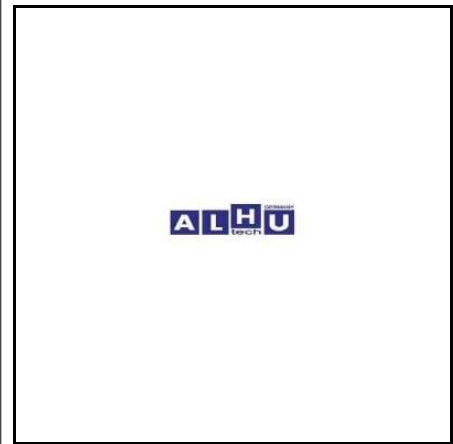

**11 543 517 WATER TEMPERATURE SENSOR**

W124 W140 W202

**Mercedes Benz**  
009 542 35 17

**BERU**  
TF 008

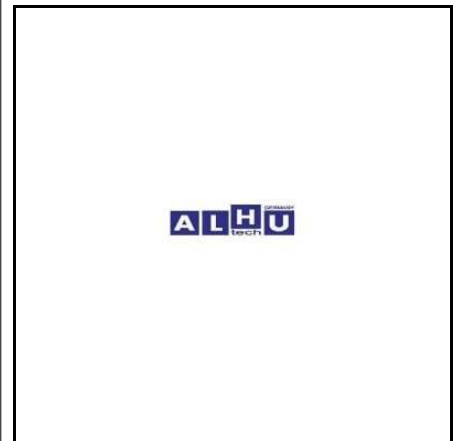

**15 454 510 WINDOW LIFTER SWITCH**

right

W124 W126 W201

**Mercedes Benz**  
124 820 45 10



Schalter / Switch

**15 454 610 WINDOW LIFTER SWITCH**  
 left  
 W124 W126 W201

**Mercedes Benz**  
 124 820 46 10



**15 458 110 WINDOW LIFTER SWITCH**  
 W123 W201

**Mercedes Benz**  
 000 820 81 10



**15 458 210 WINDOW LIFTER SWITCH**  
 W201

**Mercedes Benz**  
 000 820 82 10



**15 820 111 WINDOW LIFTER SWITCH**  
 W210

**Mercedes Benz**  
 210 820 01 10

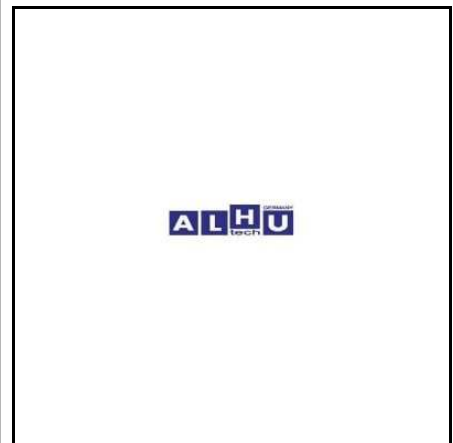

Schalter / Switch

**15 820 310 WINDOW LIFTER SWITCH**

W201

**Mercedes Benz**  
000 820 83 10



**15 820 410 WINDOW LIFTER SWITCH**

W201

**Mercedes Benz**  
000 820 84 10



**15 820 710 WINDOW LIFTER SWITCH**

W124 W126 W201

**Mercedes Benz**  
124 820 47 10



**15 820 810 WINDOW LIFTER SWITCH**

W124 W126 W201

**Mercedes Benz**  
124 820 48 10





Schalter / Switch

**15 820 910 WINDOW LIFTER SWITCH**

W124 W201

**Mercedes Benz**  
124 820 89 10



**15 821 010 WINDOW LIFTER SWITCH**  
right

**Mercedes Benz**  
126 820 80 10



**15 821 110 WINDOW LIFTER SWITCH**  
left

**Mercedes Benz**  
126 820 81 10



**15 821 210 WINDOW LIFTER SWITCH**  
left

**Mercedes Benz**  
126 820 62 10



Schalter / Switch

<b>15 822 310</b>	<b>WINDOW LIFTER SWITCH</b>
	right
<b>Mercedes Benz</b>	
126 820 63 10	



Umschlüsselung / Cross Referenz

AL-HU TECH	DB	Description	Page
632074	126 270 61 00	TRANSMISSION GASKET KIT	61
634034	124 460 01 61	GASKET SET STEERING PUMP	101
10 000 000	002 091 97 01	FUEL PUMP	153
10 000 003	123 428 02 35	BRAKE HOSE	43
10 000 004	631 428 00 35	BRAKE HOSE	43
10 000 005	210 428 00 35	BRAKE HOSE	43
10 000 006	123 428 05 35	BRAKE HOSE	44
10 000 007	140 420 00 48	BRAKE HOSE	44
10 000 008	129 428 10 35	BRAKE HOSE	44
10 000 009	001 428 95 35	BRAKE HOSE	44
10 000 017	203 320 25 89	STABILIZER LINK	28
10 000 027	202 460 04 05	DRAG LINK	99
11 000 000	115 330 18 75	CONTROL ARM KIT	95
11 000 001	116 333 40 14	RUBBER MOUNTING	22
11 000 002	123 350 00 75	CONTROL ARM KIT	95
11 000 003	123 351 10 42	RUBBER MOUNTING	22
11 000 004	123 411 00 15	FLEXIBLE DISC KIT	11
11 000 005	123 411 02 15	FLEXIBLE DISC KIT	12
11 000 006	123 500 00 12	RADIATOR MOUNTING KIT	19
11 000 007	124 240 15 17	ENGINE MOUNTING	2
11 000 008	124 240 22 17	ENGINE MOUNTING	3
11 000 009	124 320 04 73	RUBBER MOUNTING	22
11 000 010	124 320 19 47	STABILIZER KIT	27
11 000 011	124 320 21 47	STABILIZER KIT	28
11 000 012	124 323 04 26	RUBBER MOUNTING	22
11 000 013	124 323 05 26	RUBBER MOUNTING	23
11 000 014	124 323 54 85	RUBBER MOUNTING	23
11 000 015	124 323 56 85	RUBBER MOUNTING	23
11 000 016	124 333 43 14	RUBBER MOUNTING	23
11 000 017	124 351 19 42	RUBBER MOUNTING	24
11 000 018	124 352 34 65	RUBBER MOUNTING	24
11 000 019	124 352 77 65	RUBBER MOUNTING	24
11 000 020	124 411 04 15	FLEXIBLE DISC KIT	12
11 000 021	124 411 05 15	FLEXIBLE DISC KIT	12
11 000 022	124 411 06 15	FLEXIBLE DISC KIT	12
11 000 023	124 492 00 44	RUBBER MOUNTING	24
11 000 024	126 352 01 65	RUBBER MOUNTING	25
11 000 025	129 410 01 15	FLEXIBLE DISC KIT	13
11 000 026	140 240 02 17	ENGINE MOUNTING	3
11 000 027	140 240 09 18	ENGINE MOUNTING	3
11 000 028	140 240 22 17	ENGINE MOUNTING	3
11 000 029	140 333 18 14	RUBBER MOUNTING	25
11 000 030	140 350 87 08	REP KIT REAR SUBFRAME	19
11 000 031	201 320 00 47	STABILIZER KIT	28
11 000 032	201 323 23 40	RUBBER MOUNTING	25
11 000 033	201 323 55 40	RUBBER MOUNTING	25
11 000 034	201 323 56 40	RUBBER MOUNTING	26
11 000 035	201 410 05 81	PROPELLER SHAFT MOUNTING	18
11 000 036	201 410 10 15	FLEXIBLE DISC KIT	13
11 000 037	201 492 01 16	RUBBER MOUNTING	26
11 000 038	202 240 16 17	ENGINE MOUNTING	4
11 000 039	202 240 17 17	ENGINE MOUNTING	4
11 000 040	202 240 28 17	ENGINE MOUNTING	4
11 000 041	202 323 02 85	STABILIZER MOUNTING	29

Umschlüsselung / Cross Referenz

AL-HU TECH	DB	Description	Page
11 000 042	202 333 64 14	RUBBER MOUNTING	26
11 000 043	202 350 34 08	REPAIR KIT, AXLE BODY	20
11 000 044	203 240 05 17	ENGINE MOUNTING	4
11 000 045	210 351 08 42	RUBBER MOUNTING	26
11 000 046	602 321 02 50	STABILIZER MOUNTING	29
11 000 047	103 988 01 11	RUBBER MOUNTING	27
11 000 048	107 492 00 82	RUBBER MOUNTING	27
11 010 013	104 014 15 02	OIL PAN	155
11 010 213	102 010 42 13	OIL PAN	156
11 010 513	103 010 05 13	OIL PAN	156
11 010 628	112 010 06 28	OIL PAN	156
11 050 911	116 050 18 11	CHAIN ADJUSTER	125
11 050 911	117 050 09 11	CHAIN ADJUSTER	125
11 078 489	000 078 15 89	FUEL PRESSURE REGULATOR	152
11 078 489	000 078 18 89	FUEL PRESSURE REGULATOR	152
11 094 091	601 094 03 91	BOOT	124
11 094 248	112 094 00 48	AIR MASS SENSOR	109
11 094 348	000 094 09 48	AIR MASS SENSOR	109
11 094 448	000 094 10 48	AIR MASS SENSOR	110
11 094 548	113 094 00 48	AIR MASS SENSOR	110
11 094 648	000 094 00 48	AIR MASS SENSOR	110
11 094 748	000 094 08 48	AIR MASS SENSOR	110
11 094 948	111 094 01 48	AIR MASS SENSOR	111
11 095 248	611 094 00 48	AIR MASS SENSOR	111
11 095 348	000 094 05 48	AIR MASS SENSOR	111
11 130 460	116 130 04 60	IDLER PULLEY	155
11 140 160	000 140 71 60	THERMO VALVE ( RED )	165
11 140 260	001 140 62 60	THERMO VALVE BLACK	164
11 140 560	001 140 52 60	THERMO VALVE (GREEN)	165
11 140 760	001 140 07 60	THERMO VALVE ( WHITE )	165
11 145 365	000 230 43 65	VACUUM PUMP	167
11 145 565	000 230 35 65	VACUUM PUMP	168
11 145 665	000 230 36 65	VACUUM PUMP	168
11 145 665	000 230 38 65	VACUUM PUMP	168
11 156 110	000 156 72 10	SPARK PLUG ADAPTOR	162
11 156 110	000 156 75 10	SPARK PLUG ADAPTOR	162
11 156 142	000 159 41 42	SPARK PLUG ADAPTOR	162
11 156 510	000 156 66 10	SPARK PLUG ADAPTOR	163
11 156 642	000 159 35 42	SPARK PLUG ADAPTOR	163
11 156 642	000 159 36 42	SPARK PLUG ADAPTOR	163
11 156 710	000 156 57 10	SPARK PLUG ADAPTOR	163
11 156 810	000 156 67 10	SPARK PLUG ADAPTOR	163
11 156 810	000 156 68 10	SPARK PLUG ADAPTOR	163
11 158 001	000 158 43 02	DISTRIBUTOR CAP	54
11 158 002	000 158 49 02	DISTRIBUTOR CAP	54
11 158 003	103 158 00 02	DISTRIBUTOR CAP	54
11 158 004	000 158 44 02	DISTRIBUTOR CAP	54
11 158 005	000 158 27 02	DISTRIBUTOR CAP	55
11 158 006	103 158 03 31	DISTRIBUTOR ROTOR	55
11 158 007	104 158 02 31	DISTRIBUTOR ROTOR	55
11 158 008	000 158 36 31	DISTRIBUTOR ROTOR	55
11 158 009	000 158 26 31	DISTRIBUTOR ROTOR	56
11 200 001	120 200 01 22	FAN CLUTCH	145
11 200 002	603 200 00 22	FAN CLUTCH	145

Umschlüsselung / Cross Referenz

AL-HU TECH	DB	Description	Page
11 200 003	102 200 77 70	BELT TENSIONER	112
11 200 004	116 130 01 60	BELT TENSIONER PULLEY	115
11 200 005	601 200 12 70	BELT TENSIONER PULLEY	116
11 200 006	611 155 02 15	BELT TENSIONER PULLEY	116
11 200 007	611 155 07 15	PULLEY	156
11 200 008	272 202 10 19	BELT TENSIONER PULLEY	116
11 200 014	112 200 00 14	SHOCK ABSORBER	160
11 200 015	111 200 04 15	THERMOSTAT HOUSING	166
11 200 015	111 200 09 15	THERMOSTAT HOUSING	166
11 200 019	000 202 00 19	BELT TENSIONER PULLEY	116
11 200 019	000 202 09 19	BELT TENSIONER PULLEY	116
11 200 020	166 202 06 19	BELT TENSIONER PULLEY	117
11 200 021	137 202 01 19	BELT TENSIONER PULLEY	117
11 200 022	111 200 04 22	FAN CLUTCH	145
11 200 023	111 200 00 23	FAN BLADE	141
11 200 024	266 202 00 19	BELT TENSIONER PULLEY	117
11 200 025	604 150 06 60	PULLEY	157
11 200 026	611 155 04 15	PULLEY	157
11 200 027	640 202 04 19	BELT TENSIONER PULLEY	117
11 200 028	000 200 59 22	FAN CLUTCH	145
11 200 033	606 200 01 22	FAN CLUTCH	146
11 200 034	613 200 00 22	FAN CLUTCH	146
11 200 035	116 200 06 22	FAN CLUTCH	146
11 200 036	000 200 39 22	FAN CLUTCH	146
11 200 070	104 200 10 70	BELT TENSIONER PULLEY	118
11 200 072	617 200 07 20	WATER PUMP	168
11 200 114	103 200 01 14	SHOCK ABSORBER	161
11 200 115	111 200 03 15	THERMOSTAT HOUSING	166
11 200 119	111 202 01 19	BELT TENSIONER PULLEY	118
11 200 122	112 200 01 22	FAN CLUTCH	147
11 200 123	604 200 01 23	FAN BLADE	141
11 200 142	000 200 04 22	FAN CLUTCH	147
11 200 170	601 200 10 70	BELT TENSIONER PULLEY	118
11 200 180	103 200 17 28	FAN BRACKET	144
11 200 270	102 200 69 70	BELT TENSIONER	112
11 200 271	272 200 02 70	BELT TENSIONER	112
11 200 272	272 202 14 19	BELT TENSIONER PULLEY	118
11 200 280	104 200 15 28	FAN BRACKET	144
11 200 315	611 200 03 15	THERMOSTAT with housing	167
11 200 315	611 200 05 15	THERMOSTAT with housing	167
11 200 319	000 202 03 19	BELT TENSIONER PULLEY	119
11 200 323	601 200 03 23	FAN BLADE	142
11 200 370	111 200 07 70	BELT TENSIONER	112
11 200 414	102 200 14 14	SHOCK ABSORBER	161
11 200 417	102 200 04 17	THERMOSTAT HOUSING	166
11 200 422	103 200 04 22	FAN CLUTCH	147
11 200 423	603 200 04 23	FAN BLADE	142
11 200 470	103 200 08 70	BELT TENSIONER	113
11 200 514	111 200 04 14	SHOCK ABSORBER	161
11 200 515	102 200 15 15	THERMOSTAT HOUSING, complete	167
11 200 523	603 200 05 23	FAN BLADE	140
11 200 570	103 200 05 70	BELT TENSIONER PULLEY	119
11 200 622	103 200 06 22	FAN CLUTCH	147
11 200 623	103 200 06 23	FAN BLADE	142

Umschlüsselung / Cross Referenz

AL-HU TECH	DB	Description	Page
11 200 670	111 200 00 70	BELT TENSIONER PULLEY	119
11 200 722	000 200 37 22	FAN CLUTCH	148
11 200 723	102 200 20 23	FAN BLADE	142
11 200 770	601 200 07 70	BELT TENSIONER PULLEY	119
11 200 822	116 200 08 22	FAN CLUTCH	148
11 200 822	116 200 11 22	FAN CLUTCH	148
11 200 870	104 200 08 70	BELT TENSIONER	113
11 200 922	119 200 00 22	FAN CLUTCH	148
11 200 970	601 200 09 70	BELT TENSIONER PULLEY	120
11 201 070	112 200 09 70	BELT TENSIONER PULLEY	120
11 201 123	102 200 21 23	FAN BLADE	143
11 201 170	119 200 11 70	BELT TENSIONER	113
11 201 270	119 200 02 70	BELT TENSIONER	113
11 201 370	120 200 03 70	BELT TENSIONER	114
11 201 423	602 200 04 23	FAN BLADE	143
11 201 522	603 200 05 22	FAN CLUTCH	148
11 201 570	606 202 01 20	BEARING JOURNAL	111
11 201 670	119 200 03 70	BELT TENSIONER PULLEY	120
11 201 822	000 200 58 22	FAN CLUTCH	149
11 201 870	601 200 17 73	BELT TENSIONER LEVER	115
11 201 970	119 200 14 70	BELT TENSIONER PULLEY	120
11 202 022	604 200 00 22	FAN CLUTCH	149
11 202 070	104 200 05 70	BELT TENSIONER	114
11 202 122	116 200 05 22	FAN CLUTCH	149
11 202 123	110 200 01 23	FAN BLADE	143
11 202 170	120 200 04 70	BELT TENSIONER	114
11 202 222	112 200 02 22	FAN CLUTCH	149
11 202 270	611 200 03 70	BELT TENSIONER	114
11 202 270	611 200 05 70	BELT TENSIONER	114
11 202 270	646 200 02 70	BELT TENSIONER	114
11 202 423	601 200 04 23	FAN BLADE	141
11 202 470	104 200 04 70	BELT TENSIONER PULLEY	121
11 202 522	111 200 05 22	FAN CLUTCH	150
11 202 822	000 200 38 22	FAN CLUTCH	150
11 203 002	110 200 05 15	THERMOSTAT	165
11 203 003	601 200 00 15	THERMOSTAT	166
11 203 122	113 200 01 22	FAN CLUTCH	150
11 203 160	102 052 03 16	SLIDING RAIL	161
11 203 222	119 200 02 22	FAN CLUTCH	150
11 203 260	102 052 04 16	SLIDING RAIL	162
11 203 322	616 200 03 22	FAN CLUTCH	151
11 203 423	103 200 03 23	FAN BLADE	143
11 203 423	103 200 04 23	FAN BLADE	143
11 203 622	603 200 06 22	FAN CLUTCH	151
11 203 822	103 200 09 22	FAN CLUTCH	151
11 203 822	103 200 11 22	FAN CLUTCH	151
11 204 122	602 200 01 22	FAN CLUTCH	151
11 205 306	003 205 03 06	FAN BLADE	141
11 205 316	003 205 13 06	FAN BLADE	144
11 205 406	115 205 03 06	FAN BLADE	144
11 205 406	115 205 04 06	FAN BLADE	144
11 205 470	119 200 04 70	BELT TENSIONER	115
11 206 122	000 200 51 22	FAN CLUTCH	152
11 206 270	271 200 02 70	BELT TENSIONER	115

Umschlüsselung / Cross Referenz

AL-HU TECH	DB	Description	Page
11 230 011	000 230 70 11	COMPRESSOR	125
11 240 002	124 240 06 18	TRANSMISSION MOUNTING	30
11 240 003	124 240 17 17	ENGINE MOUNTING	5
11 240 003	201 240 40 17	ENGINE MOUNTING	5
11 240 004	124 240 19 17	ENGINE MOUNTING	5
11 240 004	201 240 43 17	ENGINE MOUNTING	5
11 240 005	124 240 26 17	ENGINE MOUNTING	5
11 240 006	140 240 21 17	ENGINE MOUNTING	5
11 240 007	140 240 20 17	ENGINE MOUNTING	6
11 240 008	203 240 06 17	ENGINE MOUNTING	6
11 240 009	210 240 01 17	ENGINE MOUNTING	6
11 240 010	210 240 02 17	ENGINE MOUNTING	6
11 240 012	220 240 06 17	ENGINE MOUNTING	7
11 240 013	220 240 07 17	ENGINE MOUNTING	7
11 240 014	123 241 30 13	ENGINE MOUNTING	7
11 240 015	123 241 41 13	ENGINE MOUNTING	7
11 240 016	123 241 46 13	ENGINE MOUNTING	8
11 240 017	140 240 15 17	ENGINE MOUNTING	8
11 240 018	124 240 16 17	ENGINE MOUNTING	8
11 240 019	123 240 13 18	ENGINE MOUNTING	8
11 240 020	140 240 08 18	ENGINE MOUNTING	9
11 240 021	202 240 04 18	ENGINE MOUNTING	9
11 240 022	123 241 50 13	ENGINE MOUNTING	9
11 240 023	123 241 52 13	ENGINE MOUNTING	9
11 240 024	201 241 16 13	ENGINE MOUNTING	10
11 240 025	201 241 17 13	ENGINE MOUNTING	10
11 240 026	116 240 04 18	ENGINE MOUNTING	10
11 240 027	123 240 22 18	ENGINE MOUNTING	10
11 240 028	220 240 02 18	ENGINE MOUNTING	11
11 240 029	210 240 20 17	ENGINE MOUNTING	11
11 250 115	002 250 18 15	CLUTCH RELEASE BEARING	58
11 254 808	000 254 18 08	CLUTCH RELEASE BEARING	58
11 300 030	201 300 30 30	ACCELERATION CABLE	107
11 300 130	202 300 01 30	ACCELERATION CABLE	107
11 300 330	124 300 12 30	ACCELERATION CABLE	107
11 300 430	124 300 50 30	ACCELERATION CABLE	107
11 300 530	124 300 15 30	ACCELERATION CABLE	108
11 300 630	124 300 67 30	ACCELERATION CABLE	108
11 300 730	201 300 27 30	ACCELERATION CABLE	108
11 300 830	124 300 43 30	ACCELERATION CABLE	108
11 311 023	002 154 72 06	VOLTAGE REGULATOR	57
11 311 090	002 154 58 06	VOLTAGE REGULATOR	57
11 311 090	002 154 85 06	VOLTAGE REGULATOR	57
11 330 001	210 330 87 07	CONTROL ARM	88
11 330 002	210 330 88 07	CONTROL ARM	88
11 330 003	203 330 01 11	CONTROL ARM	89
11 330 004	203 330 02 11	CONTROL ARM	89
11 330 005	203 330 19 11	CONTROL ARM	89
11 330 005	203 330 33 11	CONTROL ARM	89
11 330 006	203 330 34 11	CONTROL ARM	89
11 330 007	220 330 83 07	CONTROL ARM	90
11 330 007	220 330 93 07	CONTROL ARM	90
11 330 008	220 330 84 07	CONTROL ARM	90
11 330 008	220 330 94 07	CONTROL ARM	90

Umschlüsselung / Cross Referenz

AL-HU TECH	DB	Description	Page
11 330 009	220 330 57 11	CONTROL ARM	90
11 330 010	220 330 58 11	CONTROL ARM	90
11 330 011	220 330 90 07	CONTROL ARM	91
11 330 012	220 330 89 07	CONTROL ARM	91
11 352 165	202 352 01 65	CONTROL ARM BUSHING	94
11 352 166	203 333 09 14	CONTROL ARM BUSHING	94
11 352 167	208 323 01 40	STABILIZER BUSHING	27
11 352 168	210 333 68 14	CONTROL ARM BUSHING	94
11 352 169	211 333 10 14	CONTROL ARM BUSHING	95
11 352 170	210 350 58 08	REPAIR KIT, AXLE BODY	20
11 410 015	124 410 00 15	FLEXIBLE DISC KIT	13
11 410 016	123 410 00 15	FLEXIBLE DISC KIT	13
11 410 017	126 410 01 15	FLEXIBLE DISC KIT	14
11 410 018	201 410 07 15	FLEXIBLE DISC KIT	14
11 410 019	124 410 08 15	FLEXIBLE DISC KIT	14
11 410 020	202 410 10 15	FLEXIBLE DISC KIT	14
11 410 021	202 410 11 15	FLEXIBLE DISC KIT	15
11 410 022	202 410 13 15	FLEXIBLE DISC KIT	15
11 410 023	210 410 08 15	FLEXIBLE DISC KIT	15
11 410 024	202 410 12 15	FLEXIBLE DISC KIT	15
11 410 025	202 411 03 15	FLEXIBLE DISC KIT	16
11 410 026	202 411 06 15	FLEXIBLE DISC KIT	16
11 410 027	210 410 12 15	FLEXIBLE DISC KIT	16
11 410 028	210 411 05 15	FLEXIBLE DISC KIT	16
11 410 029	129 410 02 15	FLEXIBLE DISC KIT	17
11 410 029	210 410 11 15	FLEXIBLE DISC KIT	17
11 410 081	123 410 10 81	PROPELLER SHAFT MOUNTING	18
11 410 415	126 410 04 15	FLEXIBLE DISC KIT	17
11 410 481	202 410 04 81	PROPELLER SHAFT MOUNTING	18
11 410 581	202 410 05 81	PROPELLER SHAFT MOUNTING	18
11 410 615	124 410 06 15	FLEXIBLE DISC KIT	17
11 410 681	124 410 06 81	PROPELLER SHAFT MOUNTING	19
11 410 781	124 410 02 81	PROPELLER SHAFT MOUNTING	19
11 410 781	124 410 07 81	PROPELLER SHAFT MOUNTING	19
11 460 183	000 460 01 83	EXPANSION TANK, POWER STEERING	99
11 500 001	220 500 00 93	BLOWER MOTOR	121
11 500 003	201 500 29 03	RADIATOR	157
11 500 006	163 500 00 06	RADIATOR CAP	159
11 500 010	220 501 00 82	RADIATOR HOSE	159
11 500 049	220 500 00 49	EXPANSION TANK	136
11 500 051	221 500 03 49	EXPANSION TANK	136
11 500 093	000 500 79 93	BLOWER MOTOR	121
11 500 103	124 500 98 03	RADIATOR	157
11 500 155	124 505 01 55	GUARD, FAN SHROUD	153
11 500 203	124 500 90 03	RADIATOR	158
11 500 249	202 500 02 49	EXPANSION TANK	136
11 500 293	001 500 12 93	BLOWER MOTOR	121
11 500 303	126 500 51 03	RADIATOR	158
11 500 349	124 500 13 49	EXPANSION TANK	136
11 500 355	140 500 03 55	GUARD, FAN SHROUD	153
11 500 393	001 500 13 93	BLOWER MOTOR	122
11 500 403	126 500 48 03	RADIATOR	158
11 500 493	001 500 16 93	BLOWER MOTOR	122
11 500 493	001 500 38 93	BLOWER MOTOR	122



Umschlüsselung / Cross Referenz

AL-HU TECH	DB	Description	Page
11 500 503	140 500 21 03	RADIATOR	158
11 500 549	126 500 15 49	EXPANSION TANK	137
11 500 593	000 500 85 93	BLOWER MOTOR	122
11 500 603	201 500 46 03	RADIATOR	159
11 500 646	202 500 06 49	EXPANSION TANK	137
11 500 655	124 500 06 55	GUARD, FAN SHROUD	153
11 500 693	000 500 76 93	BLOWER MOTOR	122
11 500 749	124 500 17 49	EXPANSION TANK	137
11 500 755	124 500 07 55	GUARD, FAN SHROUD	154
11 500 758	124 830 07 58	EVAPORATOR	135
11 500 793	001 500 05 93	BLOWER MOTOR	123
11 500 849	203 500 00 49	EXPANSION TANK	137
11 500 993	000 500 60 93	BLOWER MOTOR	123
11 500 994	000 500 70 93	BLOWER MOTOR	123
11 500 994	000 500 71 93	BLOWER MOTOR	123
11 500 996	001 830 57 08	BLOWER MOTOR	123
11 501 349	163 500 03 49	EXPANSION TANK	138
11 501 355	202 505 21 55	FAN SHROUD	152
11 501 549	210 500 05 49	EXPANSION TANK	138
11 501 749	140 500 17 49	EXPANSION TANK	138
11 501 949	211 500 00 49	EXPANSION TANK	138
11 540 008	210 540 90 08	ABS SENSOR	38
11 540 024	210 545 00 24	SENSOR, COOLANT LEVEL	184
11 540 108	210 540 91 08	ABS SENSOR	38
11 540 244	124 540 02 44	SENSOR, COOLANT LEVEL	184
11 540 253	203 540 00 53	SPACER	162
11 540 253	203 540 01 53	SPACER	162
11 540 253	203 540 02 53	SPACER	162
11 540 324	129 545 02 24	SENSOR, COOLANT LEVEL	185
11 540 524	210 540 00 45	SENSOR, COOLANT LEVEL	185
11 540 624	140 540 00 17	SENSOR, COOLANT LEVEL	185
11 540 717	210 540 07 17	ABS SENSOR	38
11 542 017	124 542 00 17	SENDER OIL UNIT	183
11 542 170	009 542 08 17	OIL PRESSURE SWITCH	181
11 542 217	008 542 32 17	WATER TEMPERATURE SENSOR	189
11 542 417	006 542 94 17	OIL PRESSURE SWITCH	182
11 542 418	000 542 84 18	SENSOR, OUTER TEMPERATURE	185
11 542 517	008 542 45 17	COOLANT SWITCH ( LIGHT BLUE )	180
11 542 617	005 542 26 17	WATER TEMPERATURE SENSOR	190
11 542 817	126 542 08 17	OIL LEVEL SENSOR	181
11 543 117	011 542 51 17	TEMPERATURE SENSOR	188
11 543 317	000 542 51 18	WATER TEMPERATURE SENSOR	190
11 543 517	009 542 35 17	WATER TEMPERATURE SENSOR	190
11 545 124	006 545 91 24	SENDER UNIT100 (BLACK)	184
11 545 224	006 545 42 24	THERMO SWITCH	188
11 545 424	006 545 14 24	THERMO SWITCH 100 degrees/grey	188
11 545 524	006 545 15 24	THERMO SWITCH 100/95 (RED)	189
11 545 525	006 545 15 24	THERMO SWITCH 85 degree	189
11 545 724	006 545 37 24	THERMO SWITCH 110 degree	189
11 821 551	210 821 15 51	BLOWER REGULATOR	177
11 821 651	210 821 16 51	BLOWER REGULATOR	177
11 830 001	230 830 01 84	EXPANSION VALVE	139
11 830 002	202 830 01 84	EXPANSION VALVE	139
11 830 003	140 830 04 84	EXPANSION VALVE	139

Umschlüsselung / Cross Referenz

AL-HU TECH	DB	Description	Page
11 830 008	220 830 03 84	EXPANSION VALVE	140
11 830 009	126 830 03 84	EXPANSION VALVE	140
11 830 010	000 820 80 10	CONDENSER FAN SWITCH	180
11 830 011	140 830 01 83	DRYER BOTTLE	132
11 830 012	140 830 02 83	DRYER BOTTLE	132
11 830 013	202 830 02 83	DRYER BOTTLE	132
11 830 014	211 835 00 47	DRYER BOTTLE	133
11 830 017	164 830 00 84	EXPANSION VALVE	140
11 830 070	202 830 09 70	CONDENSOR	126
11 830 083	220 830 00 83	DRYER BOTTLE	133
11 830 170	124 830 12 70	CONDENSOR	126
11 830 170	124 830 16 70	CONDENSOR	126
11 830 183	107 830 14 83	DRYER BOTTLE	133
11 830 208	140 830 12 08	BLOWER MOTOR	62
11 830 254	203 500 12 54	CONDENSOR	126
11 830 270	124 830 10 70	CONDENSOR	126
11 830 270	124 830 17 70	CONDENSOR	126
11 830 283	210 830 03 83	DRYER BOTTLE	133
11 830 370	124 830 19 70	CONDENSOR	127
11 830 383	126 830 03 83	DRYER BOTTLE	134
11 830 470	126 830 24 70	CONDENSOR	127
11 830 570	126 830 27 70	CONDENSOR	127
11 830 570	126 830 28 70	CONDENSOR	127
11 830 670	140 830 05 70	CONDENSOR	127
11 830 770	210 830 03 70	CONDENSOR	128
11 830 870	202 830 10 70	CONDENSOR	128
11 830 883	210 830 04 83	DRYER BOTTLE	134
11 830 958	210 830 09 58	EVAPORATOR	135
11 830 970	124 830 13 70	CONDENSOR	128
11 830 983	115 835 04 71	DRYER BOTTLE	134
11 831 058	220 830 10 58	EVAPORATOR	135
11 831 083	201 830 00 83	DRYER BOTTLE	134
11 831 183	124 830 03 83	DRYER BOTTLE	135
11 831 570	210 830 02 70	CONDENSOR	128
11 831 570	210 830 05 70	CONDENSOR	128
11 831 670	202 830 05 70	CONDENSOR	129
11 831 670	202 830 08 70	CONDENSOR	129
11 831 770	901 500 05 54	CONDENSOR	129
11 831 870	203 500 10 54	CONDENSOR	129
11 831 970	203 500 08 54	CONDENSOR	129
11 832 070	168 500 04 54	CONDENSOR	130
11 832 170	163 830 00 70	CONDENSOR	130
11 832 170	163 830 01 70	CONDENSOR	130
11 832 270	211 500 01 54	CONDENSOR	130
11 832 370	638 835 01 70	CONDENSOR	130
11 832 770	201 830 22 70	CONDENSOR	131
11 832 870	201 830 12 70	CONDENSOR	131
11 832 970	201 830 28 70	CONDENSOR	131
11 880 001	201 880 01 14	CLIP, BUMPER	66
11 880 004	203 887 01 27	HANDLE, BONNET RELEASE	68
11 880 004	203 887 04 27	HANDLE, BONNET RELEASE	68
11 880 005	220 887 02 27	HANDLE, BONNET RELEASE	68
11 880 006	001 997 95 86	CLIP, BUMPER	66
11 880 007	202 997 01 86	CLIP, BUMPER	67

**Umschlüsselung / Cross Referenz**

AL-HU TECH	DB	Description	Page
11 880 008	201 990 00 50	NUT, BUMPER	72
11 981 027	601 981 00 27	BUSHING,TENSIONER PULLEY DRIVE	124
12 018 182	112 018 01 82	HOSE, CRANKSHAFT BREATHER	154
12 018 282	112 018 02 82	HOSE, CRANKSHAFT BREATHER	154
12 018 302	000 010 02 85	OIL CAP	155
12 018 302	000 018 07 02	OIL CAP	155
12 018 302	111 018 03 02	OIL CAP	155
12 018 304	210 501 07 15	RADIATOR CAP	159
12 018 382	112 018 03 82	HOSE, CRANKSHAFT BREATHER	154
12 018 482	112 018 04 82	HOSE, CRANKSHAFT BREATHER	155
12 126 295	126 277 02 95	TRANSMISSION FILTER	58
12 129 195	129 277 01 95	TRANSMISSION FILTER	59
12 140 095	140 277 00 95	TRANSMISSION FILTER	58
12 271 080	140 271 00 80	TRANSMISSION FILTER GASKET	59
12 271 180	126 271 10 80	TRANSMISSION FILTER GASKET	59
12 271 180	126 271 11 80	TRANSMISSION FILTER GASKET	59
12 271 280	220 271 03 80	TRANSMISSION FILTER GASKET	60
12 271 380	201 271 03 80	TRANSMISSION FILTER GASKET	60
12 586 195	129 277 01 95	TRANSMISSION FILTER KIT	60
12 586 295	126 277 02 95	TRANSMISSION FILTER KIT	60
13 320 189	140 320 11 89	ROD, TORSION BAR	21
13 320 289	140 320 12 89	ROD, TORSION BAR	21
13 320 444	124 320 14 44	STRUT BEARING	30
13 320 689	210 320 36 89	STABILIZER LINK	28
13 320 789	210 320 37 89	STABILIZER LINK	29
13 330 003	140 330 00 03	TIE ROD	106
13 330 051	126 330 00 51	WHEEL BEARING KIT	31
13 330 107	220 330 91 07	LINK REPAIR KIT	17
13 330 207	140 330 82 07	CONTROL ARM KIT	96
13 330 307	123 330 46 07	CONTROL ARM	91
13 330 407	123 330 47 07	CONTROL ARM	91
13 330 507	126 330 06 07	CONTROL ARM	92
13 330 575	124 330 05 75	CONTROL ARM KIT	96
13 330 607	126 330 07 07	CONTROL ARM	92
13 330 675	115 330 16 75	CONTROL ARM KIT	96
13 330 707	140 330 77 07	CONTROL ARM	92
13 330 775	124 330 07 75	CONTROL ARM KIT	96
13 330 875	115 330 17 75	CONTROL ARM KIT	97
13 330 975	124 330 09 75	CONTROL ARM KIT	97
13 331 075	202 330 00 75	CONTROL ARM KIT	97
13 331 175	123 330 13 75	CONTROL ARM KIT	97
13 331 275	123 330 14 75	CONTROL ARM KIT	98
13 331 375	124 330 06 75	CONTROL ARM KIT	98
13 331 475	210 330 04 75	CONTROL ARM KIT	98
13 331 575	126 330 00 75	CONTROL ARM KIT	98
13 331 675	201 330 00 75	CONTROL ARM KIT	99
13 333 001	163 333 00 01	CONTROL ARM	92
13 333 101	163 333 01 01	CONTROL ARM	93
13 333 327	140 333 03 27	BALL JOINT	88
13 338 415	210 338 04 15	BALL JOINT	88
13 343 028	000 420 04 02	BRAKE WEAR INDICATOR	45
13 350 175	126 350 01 75	CONTROL ARM KIT	99
13 350 206	210 350 16 06	CONTROL ARM	93
13 350 206	210 350 17 06	CONTROL ARM	93

Umschlüsselung / Cross Referenz

AL-HU TECH	DB	Description	Page
13 350 206	210 350 24 06	CONTROL ARM	93
13 350 206	210 350 25 06	CONTROL ARM	93
13 350 206	210 350 34 06	CONTROL ARM	93
13 350 406	140 350 34 06	CONTROL ARM	93
13 350 408	124 350 64 08	SUBFRAME MOUNT KIT	30
13 350 506	140 350 35 06	CONTROL ARM	93
13 350 606	140 350 36 06	CONTROL ARM	94
13 350 608	124 350 86 08	SUBFRAME MOUNT KIT	30
13 350 753	210 350 18 53	TIE ROD	106
13 351 742	201 351 27 42	CONTROL ARM BUSHING	95
13 460 819	126 460 08 19	REP. KIT, STEERING ARM	20
13 540 001	670 540 00 17	BRAKE WEAR INDICATOR	45
13 540 021	901 540 02 17	BRAKE WEAR INDICATOR	45
13 540 021	901 540 03 17	BRAKE WEAR INDICATOR	45
13 540 031	201 540 03 17	BRAKE WEAR INDICATOR	45
13 540 041	669 540 04 17	BRAKE WEAR INDICATOR	46
13 540 061	460 540 06 17	BRAKE WEAR INDICATOR	46
13 540 062	601 540 06 17	BRAKE WEAR INDICATOR	46
13 540 071	211 540 07 17	BRAKE WEAR INDICATOR	46
13 540 072	677 540 07 17	BRAKE WEAR INDICATOR	47
13 540 073	669 540 07 17	BRAKE WEAR INDICATOR	47
13 540 081	669 540 08 17	BRAKE WEAR INDICATOR	47
13 540 111	210 540 11 17	BRAKE WEAR INDICATOR	47
13 540 117	901 540 00 17	BRAKE WEAR INDICATOR	48
13 540 117	901 540 01 17	BRAKE WEAR INDICATOR	48
13 540 121	000 540 02 17	BRAKE WEAR INDICATOR	48
13 540 121	123 540 00 17	BRAKE WEAR INDICATOR	48
13 540 121	126 540 20 17	BRAKE WEAR INDICATOR	48
13 540 121	140 540 12 17	BRAKE WEAR INDICATOR	48
13 540 131	601 540 13 17	BRAKE WEAR INDICATOR	48
13 540 151	163 540 15 17	BRAKE WEAR INDICATOR	48
13 540 151	163 540 17 17	BRAKE WEAR INDICATOR	48
13 540 317	163 540 13 17	BRAKE WEAR INDICATOR	49
13 540 320	906 540 13 17	BRAKE WEAR INDICATOR	49
13 540 417	163 540 14 17	BRAKE WEAR INDICATOR	49
13 540 517	164 540 10 17	BRAKE WEAR INDICATOR	49
13 540 517	220 540 15 17	BRAKE WEAR INDICATOR	49
13 540 517	639 540 15 17	BRAKE WEAR INDICATOR	49
13 540 617	220 540 06 17	BRAKE WEAR INDICATOR	50
13 540 617	220 540 07 17	BRAKE WEAR INDICATOR	50
13 540 717	202 540 07 17	BRAKE WEAR INDICATOR	50
13 540 835	639 540 14 17	BRAKE WEAR INDICATOR	50
13 540 838	906 540 14 17	BRAKE WEAR INDICATOR	50
13 540 838	906 540 15 17	BRAKE WEAR INDICATOR	50
13 540 917	669 540 09 17	BRAKE WEAR INDICATOR	51
13 542 017	435 542 00 17	BRAKE WEAR INDICATOR	51
13 752 228	002 153 92 28	ABS SENSOR	38
13 752 428	003 153 74 28	ABS SENSOR	39
13 752 528	002 153 95 28	SENSOR, CAMSHAFT	52
13 752 628	003 153 96 28	RPM SENSOR	52
13 752 728	003 153 27 28	RPM SENSOR	52
13 752 728	003 153 28 28	RPM SENSOR	52
13 752 928	004 153 69 28	SENSOR, CAMSHAFT	52
13 753 008	204 540 01 17	ABS SENSOR	39

**Umschlüsselung / Cross Referenz**

AL-HU TECH	DB	Description	Page
13 753 009	168 540 03 17	ABS SENSOR	39
13 756 017	168 540 01 17	ABS SENSOR	39
13 756 117	220 540 01 17	ABS SENSOR	40
13 756 217	210 540 06 17	ABS SENSOR	40
13 756 317	203 540 13 17	ABS SENSOR	40
13 756 318	203 540 14 17	ABS SENSOR	40
13 756 319	211 540 23 17	ABS SENSOR	41
13 756 320	211 540 24 17	ABS SENSOR	41
13 756 417	220 540 04 17	ABS SENSOR	41
13 756 517	220 540 05 17	ABS SENSOR	41
13 756 617	202 540 26 17	ABS SENSOR	42
13 756 717	129 540 27 17	ABS SENSOR	42
13 756 817	129 540 08 17	SENSOR, WHEEL SPEED	53
13 756 917	168 540 00 17	ABS SENSOR	42
13 927 001	901 542 08 17	ABS SENSOR	42
13 927 001	901 542 17 17	ABS SENSOR	42
13 927 002	901 542 11 17	ABS SENSOR	43
13 980 016	202 980 00 16	WHEEL BEARING KIT	31
13 980 516	140 980 05 16	WHEEL BEARING KIT	31
13 980 616	124 350 05 49	WHEEL BEARING KIT	31
13 980 616	124 980 05 16	WHEEL BEARING KIT	31
13 981 001	116 330 00 51	WHEEL BEARING KIT	32
13 981 001	611 330 07 25	WHEEL BEARING KIT	32
13 981 002	123 350 00 68	WHEEL BEARING KIT	32
13 981 003	124 350 05 49	WHEEL BEARING KIT	32
13 981 003	124 980 05 16	WHEEL BEARING KIT	32
13 981 004	124 350 06 49	WHEEL BEARING KIT	32
13 981 004	124 980 04 16	WHEEL BEARING KIT	32
13 981 006	140 330 00 51	WHEEL BEARING KIT	33
13 981 006	140 330 02 51	WHEEL BEARING KIT	33
13 981 007	140 980 04 16	WHEEL BEARING KIT	33
13 981 008	140 980 05 16	WHEEL BEARING KIT	33
13 981 009	140 980 06 16	WHEEL BEARING KIT	33
13 981 009	140 980 07 16	WHEEL BEARING KIT	33
13 981 010	163 330 00 51	WHEEL BEARING KIT	34
13 981 011	201 330 00 51	WHEEL BEARING KIT	34
13 981 012	201 330 01 51	WHEEL BEARING KIT	34
13 981 013	201 330 02 51	WHEEL BEARING KIT	34
13 981 014	202 980 00 16	WHEEL BEARING KIT	35
13 981 015	202 980 01 16	WHEEL BEARING KIT	35
13 981 016	203 330 00 51	WHEEL BEARING KIT	35
13 981 017	210 330 00 51	WHEEL BEARING KIT	35
13 981 018	220 330 07 25	WHEEL BEARING KIT	36
13 981 019	220 980 00 16	WHEEL BEARING KIT	36
13 981 020	220 980 01 16	WHEEL BEARING KIT	36
13 981 021	601 350 00 68	WHEEL BEARING KIT	36
13 981 021	601 350 01 68	WHEEL BEARING KIT	36
13 981 021	601 350 02 68	WHEEL BEARING KIT	36
13 981 021	601 350 04 68	WHEEL BEARING KIT	36
13 981 022	902 350 00 68	WHEEL BEARING KIT	37
13 981 023	230 330 03 25	WHEEL HUB	37
14 460 040	202 460 07 04	LOCK CYLINDER	101
14 460 050	201 460 00 50	REP. KIT, STEERING ARM	21
14 460 104	201 460 01 04	LOCK CYLINDER	102

Umschlüsselung / Cross Referenz

AL-HU TECH	DB	Description	Page
14 460 140	202 460 11 04	LOCK CYLINDER	102
14 460 319	202 460 03 19	REP. KIT, STEERING ARM	21
14 460 404	140 460 14 04	LOCK CYLINDER	102
14 460 640	126 460 06 04	LOCK CYLINDER	102
14 460 819	140 460 08 19	REPAIR KIT, IDLER ARM	20
14 462 327	901 462 03 79	LOCK CYLINDER	71
14 462 479	123 462 04 79	LOCK CYLINDER	103
14 752 000	171 540 06 17	BRAKE WEAR INDICATOR	51
15 226 044	210 540 01 44	STEERING COLUMN SWITCH	186
15 226 144	202 540 21 44	STEERING COLUMN SWITCH	186
15 226 146	208 545 00 10	STEERING COLUMN SWITCH	186
15 226 244	124 540 20 44	STEERING COLUMN SWITCH	186
15 226 445	000 540 74 45	STEERING COLUMN SWITCH	187
15 226 445	001 540 46 45	STEERING COLUMN SWITCH	187
15 226 544	004 545 67 24	STEERING COLUMN SWITCH	187
15 226 544	005 545 41 24	STEERING COLUMN SWITCH	187
15 227 144	220 545 00 10	STEERING COLUMN SWITCH	187
15 240 018	210 240 05 18	ENGINE MOUNTING	11
15 270 001	201 270 48 01	TRANSMISSION GASKET KIT	61
15 277 195	109 270 02 98	TRANSMISSION FILTER	59
15 454 510	124 820 45 10	WINDOW LIFTER SWITCH	190
15 454 610	124 820 46 10	WINDOW LIFTER SWITCH	191
15 458 110	000 820 81 10	WINDOW LIFTER SWITCH	191
15 458 210	000 820 82 10	WINDOW LIFTER SWITCH	191
15 540 645	000 540 67 45	RELAY	182
15 540 745	201 540 37 45	RELAY	182
15 545 005	003 545 25 05	RELAY	182
15 545 009	001 545 31 09	BRAKE LIGHT SWITCH	179
15 545 009	001 545 64 09	BRAKE LIGHT SWITCH	179
15 545 014	140 545 04 14	REVERSE LIGHT SWITCH	183
15 545 014	201 545 00 14	REVERSE LIGHT SWITCH	183
15 545 709	001 545 20 09	BRAKE LIGHT SWITCH	179
15 545 832	001 545 86 32	IGNITION MODULE	56
15 545 832	002 545 18 32	IGNITION MODULE	56
15 820 010	000 820 90 10	HAZARD LAMP SWITCH	180
15 820 110	124 820 01 10	HAZARD LAMP SWITCH	181
15 820 111	210 820 01 10	WINDOW LIFTER SWITCH	191
15 820 310	000 820 83 10	WINDOW LIFTER SWITCH	192
15 820 410	000 820 84 10	WINDOW LIFTER SWITCH	192
15 820 710	124 820 47 10	WINDOW LIFTER SWITCH	192
15 820 711	124 820 27 10	BLOWER REGULATOR	178
15 820 810	124 820 48 10	WINDOW LIFTER SWITCH	192
15 820 910	124 820 89 10	WINDOW LIFTER SWITCH	193
15 821 010	126 820 80 10	WINDOW LIFTER SWITCH	193
15 821 110	126 820 81 10	WINDOW LIFTER SWITCH	193
15 821 210	126 820 62 10	WINDOW LIFTER SWITCH	193
15 821 251	124 821 21 51	BLOWER REGULATOR	178
15 821 310	140 820 63 10	SWITCH, DOOR LOCK	188
15 821 451	140 821 64 51	HAZARD LAMP SWITCH	181
15 821 710	004 820 07 10	A/C SWITCH	177
15 821 710	004 820 68 10	A/C SWITCH	177
15 821 910	202 820 39 10	SWITCH, CENTRAL DOOR LOCK	187
15 821 910	202 820 40 10	SWITCH, CENTRAL DOOR LOCK	187
15 822 310	126 820 63 10	WINDOW LIFTER SWITCH	194

Umschlüsselung / Cross Referenz

AL-HU TECH	DB	Description	Page
15 823 310	124 820 83 10	A/C SWITCH	177
15 830 572	140 830 01 72	SENDER UNIT	183
15 830 772	210 830 05 72	SENDER UNIT	184
15 830 772	210 830 07 72	SENDER UNIT	184
16 124 460	124 460 01 61	GASKET SET STEERING PUMP	100
16 140 460	124 460 29 01	GASKET SET STEERING PUMP	100
16 140 460	140 460 29 01	GASKET SET STEERING PUMP	100
16 203 320	140 463 03 32	STEERING DAMPER	103
16 230 011	000 230 90 11	COMPRESSOR	125
16 230 111	000 230 91 11	COMPRESSOR	125
16 304 320	124 463 04 32	STEERING DAMPER	103
16 305 320	000 463 51 32	STEERING DAMPER	103
16 820 001	140 820 22 42	WIPER MOTOR	83
16 820 002	220 820 07 42	WIPER MOTOR	84
16 820 408	202 820 24 08	WIPER MOTOR	84
16 820 442	202 820 64 42	WIPER MOTOR	84
16 880 020	126 880 00 20	HANDLE, HOOD RELEASE CABLE	69
17 460 001	210 460 00 61	GASKET SET STEERING PUMP	100
17 460 004	000 460 47 80	GASKET SET STEERING PUMP	101
17 460 005	000 460 44 80	GASKET SET STEERING PUMP	100
18 158 001	103 158 05 85	SUPRESSOR HOUSING	164
18 158 002	103 158 06 85	SUPRESSOR HOUSING	164
18 200 001	102 200 42 01	WATER PUMP	169
18 200 002	102 200 50 01	WATER PUMP	169
18 200 003	103 200 37 01	WATER PUMP	169
18 200 004	104 200 31 01	WATER PUMP	169
18 200 005	104 200 49 01	WATER PUMP	170
18 200 006	110 200 17 20	WATER PUMP	170
18 200 007	111 200 23 01	WATER PUMP	170
18 200 008	102 200 43 01	WATER PUMP	170
18 200 009	111 200 42 01	WATER PUMP	171
18 200 010	112 200 14 01	WATER PUMP	171
18 200 013	117 200 33 01	WATER PUMP	171
18 200 014	119 200 04 01	WATER PUMP	171
18 200 014	119 200 09 01	WATER PUMP	171
18 200 014	119 200 15 01	WATER PUMP	171
18 200 015	119 200 21 01	WATER PUMP	172
18 200 016	271 200 02 01	WATER PUMP	172
18 200 017	601 200 09 20	WATER PUMP	172
18 200 019	120 200 11 01	WATER PUMP	172
18 200 020	104 200 30 01	WATER PUMP	173
18 200 021	104 200 32 01	WATER PUMP	173
18 200 029	104 200 33 01	WATER PUMP	173
18 200 029	104 200 47 01	WATER PUMP	173
18 200 040	103 200 05 01	WATER PUMP	173
18 200 040	103 200 38 01	WATER PUMP	173
18 200 042	104 200 29 01	WATER PUMP	174
18 200 043	104 200 44 01	WATER PUMP	174
18 200 047	110 200 19 20	WATER PUMP	174
18 200 055	111 200 22 01	WATER PUMP	174
18 200 056	166 200 07 20	WATER PUMP	175
18 200 057	611 200 10 01	WATER PUMP	175
18 200 058	611 200 11 01	WATER PUMP	175
18 200 059	646 200 03 01	WATER PUMP	175

Umschlüsselung / Cross Referenz

AL-HU TECH	DB	Description	Page
18 200 122	119 200 01 22	FAN CLUTCH	152
18 200 236	103 200 02 36	TENSIONER LEVER	164
18 200 430	111 200 43 01	WATER PUMP	176
18 200 801	111 200 38 01	WATER PUMP	176
18 200 901	111 200 39 01	WATER PUMP	176
18 201 120	611 200 12 01	WATER PUMP	176
18 210 251	202 820 25 10	BLOWER REGULATOR	178
18 210 351	140 821 83 51	BLOWER REGULATOR	178
18 210 921	220 820 92 10	BLOWER REGULATOR	179
18 230 001	000 230 31 65	VACUUM PUMP	168
18 501 002	104 203 04 82	RADIATOR HOSE	160
18 501 003	220 501 03 82	RADIATOR HOSE	160
18 501 004	220 501 04 82	RADIATOR HOSE	160
18 680 025	202 680 00 25	BONNET INSULATION	65
18 680 026	124 682 00 26	HOOD PAD	71
18 680 126	210 682 02 26	HOOD PAD	71
18 680 425	124 680 14 25	HOOD PAD WITH ALUMINIUM	71
18 719 046	638 720 00 46	WINDOW LIFTER	72
18 719 146	638 720 01 46	WINDOW LIFTER	72
18 719 246	638 720 00 46	WINDOW LIFTER	72
18 719 346	638 720 01 46	WINDOW LIFTER	73
18 719 646	124 720 17 46	WINDOW LIFTER	73
18 719 746	124 720 18 46	WINDOW LIFTER	73
18 720 046	210 720 11 46	WINDOW LIFTER	73
18 720 116	210 720 01 16	DOOR STOP	67
18 720 146	210 720 12 46	WINDOW LIFTER	74
18 720 346	124 720 03 46	WINDOW LIFTER	74
18 720 446	124 720 04 46	WINDOW LIFTER	74
18 720 516	126 720 05 16	DOOR STOP	67
18 720 546	220 720 03 46	WINDOW LIFTER	74
18 720 616	140 720 06 16	DOOR STOP	68
18 720 646	220 720 04 46	WINDOW LIFTER	75
18 720 746	220 720 25 46	WINDOW LIFTER	75
18 720 846	220 720 26 46	WINDOW LIFTER	75
18 721 446	140 720 29 46	WINDOW LIFTER	75
18 721 546	140 720 30 46	WINDOW LIFTER	76
18 721 846	163 720 11 46	WINDOW LIFTER	76
18 721 946	163 720 12 46	WINDOW LIFTER	76
18 724 346	126 720 13 46	WINDOW LIFTER	76
18 724 446	126 720 14 46	WINDOW LIFTER	77
18 724 546	202 720 15 46	WINDOW LIFTER	77
18 724 646	202 720 16 46	WINDOW LIFTER	77
18 730 046	126 730 09 46	WINDOW LIFTER	77
18 730 146	126 730 10 46	WINDOW LIFTER	78
18 730 546	210 730 15 46	WINDOW LIFTER	78
18 730 646	210 730 16 46	WINDOW LIFTER	78
18 731 146	140 730 11 46	WINDOW LIFTER	78
18 731 246	140 730 12 46	WINDOW LIFTER	79
18 731 346	124 730 03 46	WINDOW LIFTER	79
18 731 446	124 730 04 46	WINDOW LIFTER	79
18 731 546	220 730 03 46	WINDOW LIFTER	79
18 731 646	220 730 04 46	WINDOW LIFTER	80
18 731 746	220 730 23 46	WINDOW LIFTER	80
18 731 846	220 730 24 46	WINDOW LIFTER	80



Umschlüsselung / Cross Referenz

AL-HU TECH	DB	Description	Page
18 732 246	163 730 01 46	WINDOW LIFTER	80
18 732 346	163 730 02 46	WINDOW LIFTER	81
18 732 446	163 730 09 46	WINDOW LIFTER	81
18 732 546	163 730 10 46	WINDOW LIFTER	81
18 734 346	202 730 13 46	WINDOW LIFTER	81
18 734 446	202 730 14 46	WINDOW LIFTER	82
18 760 361	901 760 13 61	DOOR HANDLE	67
18 820 000	163 820 21 42	BLOWER MOTOR	62
18 820 001	202 820 92 42	BLOWER MOTOR	62
18 820 043	210 820 17 42	WIPER MOTOR	84
18 820 143	140 820 00 08	WIPER MOTOR	85
18 820 210	210 820 62 10	BLOWER REGULATOR	179
18 820 243	163 820 43 42	WIPER MOTOR	85
18 820 308	202 820 23 08	WIPER MOTOR	85
18 820 342	202 820 93 42	BLOWER MOTOR	62
18 820 343	163 820 44 42	WIPER MOTOR	85
18 820 442	210 820 24 42	BLOWER MOTOR	63
18 820 443	124 820 07 08	WIPER MOTOR	86
18 820 543	210 820 18 42	WIPER MOTOR	86
18 820 608	124 820 06 08	BLOWER MOTOR	63
18 820 643	201 820 36 42	WIPER MOTOR	86
18 820 743	202 820 04 08	WIPER MOTOR	86
18 820 943	201 820 45 42	BLOWER MOTOR	63
18 821 143	202 820 03 08	WIPER MOTOR	87
18 821 342	202 820 53 42	WIPER MOTOR	87
18 830 008	000 830 82 08	BLOWER MOTOR	63
18 830 208	002 830 15 08	BLOWER MOTOR	64
18 830 408	000 830 79 08	BLOWER MOTOR	64
18 830 608	002 830 16 08	BLOWER MOTOR	64
18 835 001	002 835 30 01	HEAT EXCHANGER	69
18 835 101	002 835 63 01	HEAT EXCHANGER	69
18 835 201	002 835 52 01	HEAT EXCHANGER	70
18 835 285	000 835 22 85	BLOWER MOTOR	64
18 835 301	001 835 83 01	HEAT EXCHANGER	70
18 835 385	000 835 23 85	BLOWER MOTOR	65
18 835 401	002 835 24 01	HEAT EXCHANGER	70
18 835 701	002 835 54 01	HEAT EXCHANGER	70
18 869 121	124 869 03 21	WINDSHIELD WASHER PUMP	82
18 869 121	124 869 05 21	WINDSHIELD WASHER PUMP	82
18 869 121	129 869 00 21	WINDSHIELD WASHER PUMP	82
18 869 221	140 869 00 21	WINDSHIELD WASHER PUMP	82
18 869 221	140 869 02 21	WINDSHIELD WASHER PUMP	82
18 869 321	124 869 02 21	WINDSHIELD WASHER PUMP	82
18 869 421	210 869 08 21	WINDSHIELD WASHER PUMP	83
18 869 521	210 869 10 21	WINDSHIELD WASHER PUMP	83
18 869 621	202 869 00 21	WINDSHIELD WASHER PUMP	83
18 869 621	202 869 01 21	WINDSHIELD WASHER PUMP	83
18 880 220	124 880 02 20	HANDLE, BONNET RELEASE	68
19 545 001	001 545 21 09	BRAKE LIGHT SWITCH	180
21 200 215	611 200 02 15	THERMOSTAT HOUSING	167
21 200 215	611 200 07 15	THERMOSTAT HOUSING	167
21 300 030	901 300 10 30	ACCELERATION CABLE	109
21 301 030	901 300 16 30	ACCELERATION CABLE	109
21 301 030	901 300 17 30	ACCELERATION CABLE	109

## Umschlüsselung / Cross Referenz

AL-HU TECH	DB	Description	Page
21 830 054	906 500 00 54	CONDENSOR	131
22 270 500	140 270 65 00	TRANSMISSION GASKET KIT	61
28 760 459	901 760 04 59	HANDLE, DOOR AND SLIDING DOOR	69
29 545 114	202 545 01 14	REVERSE LIGHT SWITCH	183
58 290 002	001 988 60 81	CLIP	65
58 290 003	001 988 51 81	CLIP	65
58 290 004	001 988 49 81	CLIP	66
58 290 005	000 990 44 92	CLIP	66
63 451 420	104 094 35 82	BREATHER HOSE	124
63 451 421	104 094 36 82	BREATHER HOSE	124
63 451 422	005 153 63 28	COOLANT TEMPERATURE SENSOR	132
63 451 423	000 158 25 45	RESISTOR, black	56
63 451 424	126 350 03 37	BOOT KIT	2
63 451 425	140 350 11 37	BOOT KIT	2
63 451 426	210 357 00 91	BOOT KIT	2
63 451 426	210 357 01 91	BOOT KIT	2
63 451 427	210 460 23 00	STEERING BELLOW	29
63 451 439	204 500 05 49	EXPANSION TANK	139
63 512 0	000 460 47 80	GASKET SET STEERING PUMP	101

## Umschlüsselung OEM / Cross Reference OEM

DB	AL-HU TECH	Description	Page
000 010 02 85	12 018 302	OIL CAP	155
000 018 07 02	12 018 302	OIL CAP	155
000 078 15 89	11 078 489	FUEL PRESSURE REGULATOR	152
000 078 18 89	11 078 489	FUEL PRESSURE REGULATOR	152
000 094 00 48	11 094 648	AIR MASS SENSOR	110
000 094 05 48	11 095 348	AIR MASS SENSOR	111
000 094 08 48	11 094 748	AIR MASS SENSOR	110
000 094 09 48	11 094 348	AIR MASS SENSOR	109
000 094 10 48	11 094 448	AIR MASS SENSOR	110
000 140 71 60	11 140 160	THERMO VALVE ( RED )	165
000 156 57 10	11 156 710	SPARK PLUG ADAPTOR	163
000 156 66 10	11 156 510	SPARK PLUG ADAPTOR	163
000 156 67 10	11 156 810	SPARK PLUG ADAPTOR	163
000 156 68 10	11 156 810	SPARK PLUG ADAPTOR	163
000 156 72 10	11 156 110	SPARK PLUG ADAPTOR	162
000 156 75 10	11 156 110	SPARK PLUG ADAPTOR	162
000 158 25 45	63 451 423	RESISTOR, black	56
000 158 26 31	11 158 009	DISTRIBUTOR ROTOR	56
000 158 27 02	11 158 005	DISTRIBUTOR CAP	55
000 158 36 31	11 158 008	DISTRIBUTOR ROTOR	55
000 158 43 02	11 158 001	DISTRIBUTOR CAP	54
000 158 44 02	11 158 004	DISTRIBUTOR CAP	54
000 158 49 02	11 158 002	DISTRIBUTOR CAP	54
000 159 35 42	11 156 642	SPARK PLUG ADAPTOR	163
000 159 36 42	11 156 642	SPARK PLUG ADAPTOR	163
000 159 41 42	11 156 142	SPARK PLUG ADAPTOR	162
000 200 04 22	11 200 142	FAN CLUTCH	147
000 200 37 22	11 200 722	FAN CLUTCH	148
000 200 38 22	11 202 822	FAN CLUTCH	150
000 200 39 22	11 200 036	FAN CLUTCH	146
000 200 51 22	11 206 122	FAN CLUTCH	152
000 200 58 22	11 201 822	FAN CLUTCH	149
000 200 59 22	11 200 028	FAN CLUTCH	145
000 202 00 19	11 200 019	BELT TENSIONER PULLEY	116
000 202 03 19	11 200 319	BELT TENSIONER PULLEY	119
000 202 09 19	11 200 019	BELT TENSIONER PULLEY	116
000 230 31 65	18 230 001	VACUUM PUMP	168
000 230 35 65	11 145 565	VACUUM PUMP	168
000 230 36 65	11 145 665	VACUUM PUMP	168
000 230 38 65	11 145 665	VACUUM PUMP	168
000 230 43 65	11 145 365	VACUUM PUMP	167
000 230 70 11	11 230 011	COMPRESSOR	125
000 230 90 11	16 230 011	COMPRESSOR	125
000 230 91 11	16 230 111	COMPRESSOR	125
000 254 18 08	11 254 808	CLUTCH RELEASE BEARING	58
000 420 04 02	13 343 028	BRAKE WEAR INDICATOR	45
000 460 01 83	11 460 183	EXPANSION TANK, POWER STEERING	99
000 460 44 80	17 460 005	GASKET SET STEERING PUMP	100
000 460 47 80	17 460 004	GASKET SET STEERING PUMP	101
000 460 47 80	63 512 0	GASKET SET STEERING PUMP	101
000 463 51 32	16 305 320	STEERING DAMPER	103
000 500 60 93	11 500 993	BLOWER MOTOR	123
000 500 70 93	11 500 994	BLOWER MOTOR	123
000 500 71 93	11 500 994	BLOWER MOTOR	123

## Umschlüsselung OEM / Cross Reference OEM

DB	AL-HU TECH	Description	Page
000 500 76 93	11 500 693	BLOWER MOTOR	122
000 500 79 93	11 500 093	BLOWER MOTOR	121
000 500 85 93	11 500 593	BLOWER MOTOR	122
000 540 02 17	13 540 121	BRAKE WEAR INDICATOR	48
000 540 67 45	15 540 645	RELAY	182
000 540 74 45	15 226 445	STEERING COLUMN SWITCH	187
000 542 51 18	11 543 317	WATER TEMPERATURE SENSOR	190
000 542 84 18	11 542 418	SENSOR, OUTER TEMPERATURE	185
000 820 80 10	11 830 010	CONDENSER FAN SWITCH	180
000 820 81 10	15 458 110	WINDOW LIFTER SWITCH	191
000 820 82 10	15 458 210	WINDOW LIFTER SWITCH	191
000 820 83 10	15 820 310	WINDOW LIFTER SWITCH	192
000 820 84 10	15 820 410	WINDOW LIFTER SWITCH	192
000 820 90 10	15 820 010	HAZARD LAMP SWITCH	180
000 830 79 08	18 830 408	BLOWER MOTOR	64
000 830 82 08	18 830 008	BLOWER MOTOR	63
000 835 22 85	18 835 285	BLOWER MOTOR	64
000 835 23 85	18 835 385	BLOWER MOTOR	65
000 990 44 92	58 290 005	CLIP	66
001 140 07 60	11 140 760	THERMO VALVE ( WHITE )	165
001 140 52 60	11 140 560	THERMO VALVE (GREEN)	165
001 140 62 60	11 140 260	THERMO VALVE BLACK	164
001 428 95 35	10 000 009	BRAKE HOSE	44
001 500 05 93	11 500 793	BLOWER MOTOR	123
001 500 12 93	11 500 293	BLOWER MOTOR	121
001 500 13 93	11 500 393	BLOWER MOTOR	122
001 500 16 93	11 500 493	BLOWER MOTOR	122
001 500 38 93	11 500 493	BLOWER MOTOR	122
001 540 46 45	15 226 445	STEERING COLUMN SWITCH	187
001 545 20 09	15 545 709	BRAKE LIGHT SWITCH	179
001 545 21 09	19 545 001	BRAKE LIGHT SWITCH	180
001 545 31 09	15 545 009	BRAKE LIGHT SWITCH	179
001 545 64 09	15 545 009	BRAKE LIGHT SWITCH	179
001 545 86 32	15 545 832	IGNITION MODULE	56
001 830 57 08	11 500 996	BLOWER MOTOR	123
001 835 83 01	18 835 301	HEAT EXCHANGER	70
001 988 49 81	58 290 004	CLIP	66
001 988 51 81	58 290 003	CLIP	65
001 988 60 81	58 290 002	CLIP	65
001 997 95 86	11 880 006	CLIP, BUMPER	66
002 091 97 01	10 000 000	FUEL PUMP	153
002 153 92 28	13 752 228	ABS SENSOR	38
002 153 95 28	13 752 528	SENSOR, CAMSHAFT	52
002 154 58 06	11 311 090	VOLTAGE REGULATOR	57
002 154 72 06	11 311 023	VOLTAGE REGULATOR	57
002 154 85 06	11 311 090	VOLTAGE REGULATOR	57
002 250 18 15	11 250 115	CLUTCH RELEASE BEARING	58
002 545 18 32	15 545 832	IGNITION MODULE	56
002 830 15 08	18 830 208	BLOWER MOTOR	64
002 830 16 08	18 830 608	BLOWER MOTOR	64
002 835 24 01	18 835 401	HEAT EXCHANGER	70
002 835 30 01	18 835 001	HEAT EXCHANGER	69
002 835 52 01	18 835 201	HEAT EXCHANGER	70
002 835 54 01	18 835 701	HEAT EXCHANGER	70

Umschlüsselung OEM / Cross Reference OEM

DB	AL-HU TECH	Description	Page
002 835 63 01	18 835 101	HEAT EXCHANGER	69
003 153 27 28	13 752 728	RPM SENSOR	52
003 153 28 28	13 752 728	RPM SENSOR	52
003 153 74 28	13 752 428	ABS SENSOR	39
003 153 96 28	13 752 628	RPM SENSOR	52
003 205 03 06	11 205 306	FAN BLADE	141
003 205 13 06	11 205 316	FAN BLADE	144
003 545 25 05	15 545 005	RELAY	182
004 153 69 28	13 752 928	SENSOR, CAMSHAFT	52
004 545 67 24	15 226 544	STEERING COLUMN SWITCH	187
004 820 07 10	15 821 710	A/C SWITCH	177
004 820 68 10	15 821 710	A/C SWITCH	177
005 153 63 28	63 451 422	COOLANT TEMPERATURE SENSOR	132
005 542 26 17	11 542 617	WATER TEMPERATURE SENSOR	190
005 545 41 24	15 226 544	STEERING COLUMN SWITCH	187
006 542 94 17	11 542 417	OIL PRESSURE SWITCH	182
006 545 14 24	11 545 424	THERMO SWITCH 100 degrees/grey	188
006 545 15 24	11 545 524	THERMO SWITCH 100/95 (RED)	189
006 545 15 24	11 545 525	THERMO SWITCH 85 degree	189
006 545 37 24	11 545 724	THERMO SWITCH 110 degree	189
006 545 42 24	11 545 224	THERMO SWITCH	188
006 545 91 24	11 545 124	SENDER UNIT100 (BLACK)	184
008 542 32 17	11 542 217	WATER TEMPERATURE SENSOR	189
008 542 45 17	11 542 517	COOLANT SWITCH ( LIGHT BLUE )	180
009 542 08 17	11 542 170	OIL PRESSURE SWITCH	181
009 542 35 17	11 543 517	WATER TEMPERATURE SENSOR	190
011 542 51 17	11 543 117	TEMPERATURE SENSOR	188
102 010 42 13	11 010 213	OIL PAN	156
102 052 03 16	11 203 160	SLIDING RAIL	161
102 052 04 16	11 203 260	SLIDING RAIL	162
102 200 04 17	11 200 417	THERMOSTAT HOUSING	166
102 200 14 14	11 200 414	SHOCK ABSORBER	161
102 200 15 15	11 200 515	THERMOSTAT HOUSING, complete	167
102 200 20 23	11 200 723	FAN BLADE	142
102 200 21 23	11 201 123	FAN BLADE	143
102 200 42 01	18 200 001	WATER PUMP	169
102 200 43 01	18 200 008	WATER PUMP	170
102 200 50 01	18 200 002	WATER PUMP	169
102 200 69 70	11 200 270	BELT TENSIONER	112
102 200 77 70	11 200 003	BELT TENSIONER	112
103 010 05 13	11 010 513	OIL PAN	156
103 158 00 02	11 158 003	DISTRIBUTOR CAP	54
103 158 03 31	11 158 006	DISTRIBUTOR ROTOR	55
103 158 05 85	18 158 001	SUPRESSOR HOUSING	164
103 158 06 85	18 158 002	SUPRESSOR HOUSING	164
103 200 01 14	11 200 114	SHOCK ABSORBER	161
103 200 02 36	18 200 236	TENSIONER LEVER	164
103 200 03 23	11 203 423	FAN BLADE	143
103 200 04 22	11 200 422	FAN CLUTCH	147
103 200 04 23	11 203 423	FAN BLADE	143
103 200 05 01	18 200 040	WATER PUMP	173
103 200 05 70	11 200 570	BELT TENSIONER PULLEY	119
103 200 06 22	11 200 622	FAN CLUTCH	147
103 200 06 23	11 200 623	FAN BLADE	142

Umschlüsselung OEM / Cross Reference OEM

DB	AL-HU TECH	Description	Page
103 200 08 70	11 200 470	BELT TENSIONER	113
103 200 09 22	11 203 822	FAN CLUTCH	151
103 200 11 22	11 203 822	FAN CLUTCH	151
103 200 17 28	11 200 180	FAN BRACKET	144
103 200 37 01	18 200 003	WATER PUMP	169
103 200 38 01	18 200 040	WATER PUMP	173
103 988 01 11	11 000 047	RUBBER MOUNTING	27
104 014 15 02	11 010 013	OIL PAN	155
104 094 35 82	63 451 420	BREATHER HOSE	124
104 094 36 82	63 451 421	BREATHER HOSE	124
104 158 02 31	11 158 007	DISTRIBUTOR ROTOR	55
104 200 04 70	11 202 470	BELT TENSIONER PULLEY	121
104 200 05 70	11 202 070	BELT TENSIONER	114
104 200 08 70	11 200 870	BELT TENSIONER	113
104 200 10 70	11 200 070	BELT TENSIONER PULLEY	118
104 200 15 28	11 200 280	FAN BRACKET	144
104 200 29 01	18 200 042	WATER PUMP	174
104 200 30 01	18 200 020	WATER PUMP	173
104 200 31 01	18 200 004	WATER PUMP	169
104 200 32 01	18 200 021	WATER PUMP	173
104 200 33 01	18 200 029	WATER PUMP	173
104 200 44 01	18 200 043	WATER PUMP	174
104 200 47 01	18 200 029	WATER PUMP	173
104 200 49 01	18 200 005	WATER PUMP	170
104 203 04 82	18 501 002	RADIATOR HOSE	160
107 492 00 82	11 000 048	RUBBER MOUNTING	27
107 830 14 83	11 830 183	DRYER BOTTLE	133
109 270 02 98	15 277 195	TRANSMISSION FILTER	59
110 200 01 23	11 202 123	FAN BLADE	143
110 200 05 15	11 203 002	THERMOSTAT	165
110 200 17 20	18 200 006	WATER PUMP	170
110 200 19 20	18 200 047	WATER PUMP	174
111 018 03 02	12 018 302	OIL CAP	155
111 094 01 48	11 094 948	AIR MASS SENSOR	111
111 200 00 23	11 200 023	FAN BLADE	141
111 200 00 70	11 200 670	BELT TENSIONER PULLEY	119
111 200 03 15	11 200 115	THERMOSTAT HOUSING	166
111 200 04 14	11 200 514	SHOCK ABSORBER	161
111 200 04 15	11 200 015	THERMOSTAT HOUSING	166
111 200 04 22	11 200 022	FAN CLUTCH	145
111 200 05 22	11 202 522	FAN CLUTCH	150
111 200 07 70	11 200 370	BELT TENSIONER	112
111 200 09 15	11 200 015	THERMOSTAT HOUSING	166
111 200 22 01	18 200 055	WATER PUMP	174
111 200 23 01	18 200 007	WATER PUMP	170
111 200 38 01	18 200 801	WATER PUMP	176
111 200 39 01	18 200 901	WATER PUMP	176
111 200 42 01	18 200 009	WATER PUMP	171
111 200 43 01	18 200 430	WATER PUMP	176
111 202 01 19	11 200 119	BELT TENSIONER PULLEY	118
112 010 06 28	11 010 628	OIL PAN	156
112 018 01 82	12 018 182	HOSE, CRANKSHAFT BREATHER	154
112 018 02 82	12 018 282	HOSE, CRANKSHAFT BREATHER	154
112 018 03 82	12 018 382	HOSE, CRANKSHAFT BREATHER	154

Umschlüsselung OEM / Cross Reference OEM

DB	AL-HU TECH	Description	Page
112 018 04 82	12 018 482	HOSE, CRANKSHAFT BREATHER	155
112 094 00 48	11 094 248	AIR MASS SENSOR	109
112 200 00 14	11 200 014	SHOCK ABSORBER	160
112 200 01 22	11 200 122	FAN CLUTCH	147
112 200 02 22	11 202 222	FAN CLUTCH	149
112 200 09 70	11 201 070	BELT TENSIONER PULLEY	120
112 200 14 01	18 200 010	WATER PUMP	171
113 094 00 48	11 094 548	AIR MASS SENSOR	110
113 200 01 22	11 203 122	FAN CLUTCH	150
115 205 03 06	11 205 406	FAN BLADE	144
115 205 04 06	11 205 406	FAN BLADE	144
115 330 16 75	13 330 675	CONTROL ARM KIT	96
115 330 17 75	13 330 875	CONTROL ARM KIT	97
115 330 18 75	11 000 000	CONTROL ARM KIT	95
115 835 04 71	11 830 983	DRYER BOTTLE	134
116 050 18 11	11 050 911	CHAIN ADJUSTER	125
116 130 01 60	11 200 004	BELT TENSIONER PULLEY	115
116 130 04 60	11 130 460	IDLER PULLEY	155
116 200 05 22	11 202 122	FAN CLUTCH	149
116 200 06 22	11 200 035	FAN CLUTCH	146
116 200 08 22	11 200 822	FAN CLUTCH	148
116 200 11 22	11 200 822	FAN CLUTCH	148
116 240 04 18	11 240 026	ENGINE MOUNTING	10
116 330 00 51	13 981 001	WHEEL BEARING KIT	32
116 333 40 14	11 000 001	RUBBER MOUNTING	22
117 050 09 11	11 050 911	CHAIN ADJUSTER	125
117 200 33 01	18 200 013	WATER PUMP	171
119 200 00 22	11 200 922	FAN CLUTCH	148
119 200 01 22	18 200 122	FAN CLUTCH	152
119 200 02 22	11 203 222	FAN CLUTCH	150
119 200 02 70	11 201 270	BELT TENSIONER	113
119 200 03 70	11 201 670	BELT TENSIONER PULLEY	120
119 200 04 01	18 200 014	WATER PUMP	171
119 200 04 70	11 205 470	BELT TENSIONER	115
119 200 09 01	18 200 014	WATER PUMP	171
119 200 11 70	11 201 170	BELT TENSIONER	113
119 200 14 70	11 201 970	BELT TENSIONER PULLEY	120
119 200 15 01	18 200 014	WATER PUMP	171
119 200 21 01	18 200 015	WATER PUMP	172
120 200 01 22	11 200 001	FAN CLUTCH	145
120 200 03 70	11 201 370	BELT TENSIONER	114
120 200 04 70	11 202 170	BELT TENSIONER	114
120 200 11 01	18 200 019	WATER PUMP	172
123 240 13 18	11 240 019	ENGINE MOUNTING	8
123 240 22 18	11 240 027	ENGINE MOUNTING	10
123 241 30 13	11 240 014	ENGINE MOUNTING	7
123 241 41 13	11 240 015	ENGINE MOUNTING	7
123 241 46 13	11 240 016	ENGINE MOUNTING	8
123 241 50 13	11 240 022	ENGINE MOUNTING	9
123 241 52 13	11 240 023	ENGINE MOUNTING	9
123 330 13 75	13 331 175	CONTROL ARM KIT	97
123 330 14 75	13 331 275	CONTROL ARM KIT	98
123 330 46 07	13 330 307	CONTROL ARM	91
123 330 47 07	13 330 407	CONTROL ARM	91

Umschlüsselung OEM / Cross Reference OEM

DB	AL-HU TECH	Description	Page
123 350 00 68	13 981 002	WHEEL BEARING KIT	32
123 350 00 75	11 000 002	CONTROL ARM KIT	95
123 351 10 42	11 000 003	RUBBER MOUNTING	22
123 410 00 15	11 410 016	FLEXIBLE DISC KIT	13
123 410 10 81	11 410 081	PROPELLER SHAFT MOUNTING	18
123 411 00 15	11 000 004	FLEXIBLE DISC KIT	11
123 411 02 15	11 000 005	FLEXIBLE DISC KIT	12
123 428 02 35	10 000 003	BRAKE HOSE	43
123 428 05 35	10 000 006	BRAKE HOSE	44
123 462 04 79	14 462 479	LOCK CYLINDER	103
123 500 00 12	11 000 006	RADIATOR MOUNTING KIT	19
123 540 00 17	13 540 121	BRAKE WEAR INDICATOR	48
124 240 06 18	11 240 002	TRANSMISSION MOUNTING	30
124 240 15 17	11 000 007	ENGINE MOUNTING	2
124 240 16 17	11 240 018	ENGINE MOUNTING	8
124 240 17 17	11 240 003	ENGINE MOUNTING	5
124 240 19 17	11 240 004	ENGINE MOUNTING	5
124 240 22 17	11 000 008	ENGINE MOUNTING	3
124 240 26 17	11 240 005	ENGINE MOUNTING	5
124 300 12 30	11 300 330	ACCELERATION CABLE	107
124 300 15 30	11 300 530	ACCELERATION CABLE	108
124 300 43 30	11 300 830	ACCELERATION CABLE	108
124 300 50 30	11 300 430	ACCELERATION CABLE	107
124 300 67 30	11 300 630	ACCELERATION CABLE	108
124 320 04 73	11 000 009	RUBBER MOUNTING	22
124 320 14 44	13 320 444	STRUT BEARING	30
124 320 19 47	11 000 010	STABILIZER KIT	27
124 320 21 47	11 000 011	STABILIZER KIT	28
124 323 04 26	11 000 012	RUBBER MOUNTING	22
124 323 05 26	11 000 013	RUBBER MOUNTING	23
124 323 54 85	11 000 014	RUBBER MOUNTING	23
124 323 56 85	11 000 015	RUBBER MOUNTING	23
124 330 05 75	13 330 575	CONTROL ARM KIT	96
124 330 06 75	13 331 375	CONTROL ARM KIT	98
124 330 07 75	13 330 775	CONTROL ARM KIT	96
124 330 09 75	13 330 975	CONTROL ARM KIT	97
124 333 43 14	11 000 016	RUBBER MOUNTING	23
124 350 05 49	13 980 616	WHEEL BEARING KIT	31
124 350 05 49	13 981 003	WHEEL BEARING KIT	32
124 350 06 49	13 981 004	WHEEL BEARING KIT	32
124 350 64 08	13 350 408	SUBFRAME MOUNT KIT	30
124 350 86 08	13 350 608	SUBFRAME MOUNT KIT	30
124 351 19 42	11 000 017	RUBBER MOUNTING	24
124 352 34 65	11 000 018	RUBBER MOUNTING	24
124 352 77 65	11 000 019	RUBBER MOUNTING	24
124 410 00 15	11 410 015	FLEXIBLE DISC KIT	13
124 410 02 81	11 410 781	PROPELLER SHAFT MOUNTING	19
124 410 06 15	11 410 615	FLEXIBLE DISC KIT	17
124 410 06 81	11 410 681	PROPELLER SHAFT MOUNTING	19
124 410 07 81	11 410 781	PROPELLER SHAFT MOUNTING	19
124 410 08 15	11 410 019	FLEXIBLE DISC KIT	14
124 411 04 15	11 000 020	FLEXIBLE DISC KIT	12
124 411 05 15	11 000 021	FLEXIBLE DISC KIT	12
124 411 06 15	11 000 022	FLEXIBLE DISC KIT	12



Umschlüsselung OEM / Cross Reference OEM

DB	AL-HU TECH	Description	Page
124 460 01 61	16 124 460	GASKET SET STEERING PUMP	100
124 460 01 61	634034	GASKET SET STEERING PUMP	101
124 460 29 01	16 140 460	GASKET SET STEERING PUMP	100
124 463 04 32	16 304 320	STEERING DAMPER	103
124 492 00 44	11 000 023	RUBBER MOUNTING	24
124 500 06 55	11 500 655	GUARD, FAN SHROUD	153
124 500 07 55	11 500 755	GUARD, FAN SHROUD	154
124 500 13 49	11 500 349	EXPANSION TANK	136
124 500 17 49	11 500 749	EXPANSION TANK	137
124 500 90 03	11 500 203	RADIATOR	158
124 500 98 03	11 500 103	RADIATOR	157
124 505 01 55	11 500 155	GUARD, FAN SHROUD	153
124 540 02 44	11 540 244	SENSOR, COOLANT LEVEL	184
124 540 20 44	15 226 244	STEERING COLUMN SWITCH	186
124 542 00 17	11 542 017	SENDER OIL UNIT	183
124 680 14 25	18 680 425	HOOD PAD WITH ALUMINIUM	71
124 682 00 26	18 680 026	HOOD PAD	71
124 720 03 46	18 720 346	WINDOW LIFTER	74
124 720 04 46	18 720 446	WINDOW LIFTER	74
124 720 17 46	18 719 646	WINDOW LIFTER	73
124 720 18 46	18 719 746	WINDOW LIFTER	73
124 730 03 46	18 731 346	WINDOW LIFTER	79
124 730 04 46	18 731 446	WINDOW LIFTER	79
124 820 01 10	15 820 110	HAZARD LAMP SWITCH	181
124 820 06 08	18 820 608	BLOWER MOTOR	63
124 820 07 08	18 820 443	WIPER MOTOR	86
124 820 27 10	15 820 711	BLOWER REGULATOR	178
124 820 45 10	15 454 510	WINDOW LIFTER SWITCH	190
124 820 46 10	15 454 610	WINDOW LIFTER SWITCH	191
124 820 47 10	15 820 710	WINDOW LIFTER SWITCH	192
124 820 48 10	15 820 810	WINDOW LIFTER SWITCH	192
124 820 83 10	15 823 310	A/C SWITCH	177
124 820 89 10	15 820 910	WINDOW LIFTER SWITCH	193
124 821 21 51	15 821 251	BLOWER REGULATOR	178
124 830 03 83	11 831 183	DRYER BOTTLE	135
124 830 07 58	11 500 758	EVAPORATOR	135
124 830 10 70	11 830 270	CONDENSOR	126
124 830 12 70	11 830 170	CONDENSOR	126
124 830 13 70	11 830 970	CONDENSOR	128
124 830 16 70	11 830 170	CONDENSOR	126
124 830 17 70	11 830 270	CONDENSOR	126
124 830 19 70	11 830 370	CONDENSOR	127
124 869 02 21	18 869 321	WINDSHIELD WASHER PUMP	82
124 869 03 21	18 869 121	WINDSHIELD WASHER PUMP	82
124 869 05 21	18 869 121	WINDSHIELD WASHER PUMP	82
124 880 02 20	18 880 220	HANDLE, BONNET RELEASE	68
124 980 04 16	13 981 004	WHEEL BEARING KIT	32
124 980 05 16	13 980 616	WHEEL BEARING KIT	31
124 980 05 16	13 981 003	WHEEL BEARING KIT	32
126 270 61 00	632074	TRANSMISSION GASKET KIT	61
126 271 10 80	12 271 180	TRANSMISSION FILTER GASKET	59
126 271 11 80	12 271 180	TRANSMISSION FILTER GASKET	59
126 277 02 95	12 126 295	TRANSMISSION FILTER	58
126 277 02 95	12 586 295	TRANSMISSION FILTER KIT	60

## Umschlüsselung OEM / Cross Reference OEM

DB	AL-HU TECH	Description	Page
126 330 00 51	13 330 051	WHEEL BEARING KIT	31
126 330 00 75	13 331 575	CONTROL ARM KIT	98
126 330 06 07	13 330 507	CONTROL ARM	92
126 330 07 07	13 330 607	CONTROL ARM	92
126 350 01 75	13 350 175	CONTROL ARM KIT	99
126 350 03 37	63 451 424	BOOT KIT	2
126 352 01 65	11 000 024	RUBBER MOUNTING	25
126 410 01 15	11 410 017	FLEXIBLE DISC KIT	14
126 410 04 15	11 410 415	FLEXIBLE DISC KIT	17
126 460 06 04	14 460 640	LOCK CYLINDER	102
126 460 08 19	13 460 819	REP. KIT, STEERING ARM	20
126 500 15 49	11 500 549	EXPANSION TANK	137
126 500 48 03	11 500 403	RADIATOR	158
126 500 51 03	11 500 303	RADIATOR	158
126 540 20 17	13 540 121	BRAKE WEAR INDICATOR	48
126 542 08 17	11 542 817	OIL LEVEL SENSOR	181
126 720 05 16	18 720 516	DOOR STOP	67
126 720 13 46	18 724 346	WINDOW LIFTER	76
126 720 14 46	18 724 446	WINDOW LIFTER	77
126 730 09 46	18 730 046	WINDOW LIFTER	77
126 730 10 46	18 730 146	WINDOW LIFTER	78
126 820 62 10	15 821 210	WINDOW LIFTER SWITCH	193
126 820 63 10	15 822 310	WINDOW LIFTER SWITCH	194
126 820 80 10	15 821 010	WINDOW LIFTER SWITCH	193
126 820 81 10	15 821 110	WINDOW LIFTER SWITCH	193
126 830 03 83	11 830 383	DRYER BOTTLE	134
126 830 03 84	11 830 009	EXPANSION VALVE	140
126 830 24 70	11 830 470	CONDENSOR	127
126 830 27 70	11 830 570	CONDENSOR	127
126 830 28 70	11 830 570	CONDENSOR	127
126 880 00 20	16 880 020	HANDLE, HOOD RELEASE CABLE	69
129 277 01 95	12 129 195	TRANSMISSION FILTER	59
129 277 01 95	12 586 195	TRANSMISSION FILTER KIT	60
129 410 01 15	11 000 025	FLEXIBLE DISC KIT	13
129 410 02 15	11 410 029	FLEXIBLE DISC KIT	17
129 428 10 35	10 000 008	BRAKE HOSE	44
129 540 08 17	13 756 817	SENSOR, WHEEL SPEED	53
129 540 27 17	13 756 717	ABS SENSOR	42
129 545 02 24	11 540 324	SENSOR, COOLANT LEVEL	185
129 869 00 21	18 869 121	WINDSHIELD WASHER PUMP	82
137 202 01 19	11 200 021	BELT TENSIONER PULLEY	117
140 240 02 17	11 000 026	ENGINE MOUNTING	3
140 240 08 18	11 240 020	ENGINE MOUNTING	9
140 240 09 18	11 000 027	ENGINE MOUNTING	3
140 240 15 17	11 240 017	ENGINE MOUNTING	8
140 240 20 17	11 240 007	ENGINE MOUNTING	6
140 240 21 17	11 240 006	ENGINE MOUNTING	5
140 240 22 17	11 000 028	ENGINE MOUNTING	3
140 270 65 00	22 270 500	TRANSMISSION GASKET KIT	61
140 271 00 80	12 271 080	TRANSMISSION FILTER GASKET	59
140 277 00 95	12 140 095	TRANSMISSION FILTER	58
140 320 11 89	13 320 189	ROD, TORSION BAR	21
140 320 12 89	13 320 289	ROD, TORSION BAR	21
140 330 00 03	13 330 003	TIE ROD	106

## Umschlüsselung OEM / Cross Reference OEM

DB	AL-HU TECH	Description	Page
140 330 00 51	13 981 006	WHEEL BEARING KIT	33
140 330 02 51	13 981 006	WHEEL BEARING KIT	33
140 330 77 07	13 330 707	CONTROL ARM	92
140 330 82 07	13 330 207	CONTROL ARM KIT	96
140 333 03 27	13 333 327	BALL JOINT	88
140 333 18 14	11 000 029	RUBBER MOUNTING	25
140 350 11 37	63 451 425	BOOT KIT	2
140 350 34 06	13 350 406	CONTROL ARM	93
140 350 35 06	13 350 506	CONTROL ARM	93
140 350 36 06	13 350 606	CONTROL ARM	94
140 350 87 08	11 000 030	REP KIT REAR SUBFRAME	19
140 420 00 48	10 000 007	BRAKE HOSE	44
140 460 08 19	14 460 819	REPAIR KIT, IDLER ARM	20
140 460 14 04	14 460 404	LOCK CYLINDER	102
140 460 29 01	16 140 460	GASKET SET STEERING PUMP	100
140 463 03 32	16 203 320	STEERING DAMPER	103
140 500 03 55	11 500 355	GUARD, FAN SHROUD	153
140 500 17 49	11 501 749	EXPANSION TANK	138
140 500 21 03	11 500 503	RADIATOR	158
140 540 00 17	11 540 624	SENSOR, COOLANT LEVEL	185
140 540 12 17	13 540 121	BRAKE WEAR INDICATOR	48
140 545 04 14	15 545 014	REVERSE LIGHT SWITCH	183
140 720 06 16	18 720 616	DOOR STOP	68
140 720 29 46	18 721 446	WINDOW LIFTER	75
140 720 30 46	18 721 546	WINDOW LIFTER	76
140 730 11 46	18 731 146	WINDOW LIFTER	78
140 730 12 46	18 731 246	WINDOW LIFTER	79
140 820 00 08	18 820 143	WIPER MOTOR	85
140 820 22 42	16 820 001	WIPER MOTOR	83
140 820 63 10	15 821 310	SWITCH, DOOR LOCK	188
140 821 64 51	15 821 451	HAZARD LAMP SWITCH	181
140 821 83 51	18 210 351	BLOWER REGULATOR	178
140 830 01 72	15 830 572	SENDER UNIT	183
140 830 01 83	11 830 011	DRYER BOTTLE	132
140 830 02 83	11 830 012	DRYER BOTTLE	132
140 830 04 84	11 830 003	EXPANSION VALVE	139
140 830 05 70	11 830 670	CONDENSOR	127
140 830 12 08	11 830 208	BLOWER MOTOR	62
140 869 00 21	18 869 221	WINDSHIELD WASHER PUMP	82
140 869 02 21	18 869 221	WINDSHIELD WASHER PUMP	82
140 980 04 16	13 981 007	WHEEL BEARING KIT	33
140 980 05 16	13 980 516	WHEEL BEARING KIT	31
140 980 05 16	13 981 008	WHEEL BEARING KIT	33
140 980 06 16	13 981 009	WHEEL BEARING KIT	33
140 980 07 16	13 981 009	WHEEL BEARING KIT	33
163 330 00 51	13 981 010	WHEEL BEARING KIT	34
163 333 00 01	13 333 001	CONTROL ARM	92
163 333 01 01	13 333 101	CONTROL ARM	93
163 500 00 06	11 500 006	RADIATOR CAP	159
163 500 03 49	11 501 349	EXPANSION TANK	138
163 540 13 17	13 540 317	BRAKE WEAR INDICATOR	49
163 540 14 17	13 540 417	BRAKE WEAR INDICATOR	49
163 540 15 17	13 540 151	BRAKE WEAR INDICATOR	48
163 540 17 17	13 540 151	BRAKE WEAR INDICATOR	48

Umschlüsselung OEM / Cross Reference OEM

DB	AL-HU TECH	Description	Page
163 720 11 46	18 721 846	WINDOW LIFTER	76
163 720 12 46	18 721 946	WINDOW LIFTER	76
163 730 01 46	18 732 246	WINDOW LIFTER	80
163 730 02 46	18 732 346	WINDOW LIFTER	81
163 730 09 46	18 732 446	WINDOW LIFTER	81
163 730 10 46	18 732 546	WINDOW LIFTER	81
163 820 21 42	18 820 000	BLOWER MOTOR	62
163 820 43 42	18 820 243	WIPER MOTOR	85
163 820 44 42	18 820 343	WIPER MOTOR	85
163 830 00 70	11 832 170	CONDENSOR	130
163 830 01 70	11 832 170	CONDENSOR	130
164 540 10 17	13 540 517	BRAKE WEAR INDICATOR	49
164 830 00 84	11 830 017	EXPANSION VALVE	140
166 200 07 20	18 200 056	WATER PUMP	175
166 202 06 19	11 200 020	BELT TENSIONER PULLEY	117
168 500 04 54	11 832 070	CONDENSOR	130
168 540 00 17	13 756 917	ABS SENSOR	42
168 540 01 17	13 756 017	ABS SENSOR	39
168 540 03 17	13 753 009	ABS SENSOR	39
171 540 06 17	14 752 000	BRAKE WEAR INDICATOR	51
201 240 40 17	11 240 003	ENGINE MOUNTING	5
201 240 43 17	11 240 004	ENGINE MOUNTING	5
201 241 16 13	11 240 024	ENGINE MOUNTING	10
201 241 17 13	11 240 025	ENGINE MOUNTING	10
201 270 48 01	15 270 001	TRANSMISSION GASKET KIT	61
201 271 03 80	12 271 380	TRANSMISSION FILTER GASKET	60
201 300 27 30	11 300 730	ACCELERATION CABLE	108
201 300 30 30	11 300 030	ACCELERATION CABLE	107
201 320 00 47	11 000 031	STABILIZER KIT	28
201 323 23 40	11 000 032	RUBBER MOUNTING	25
201 323 55 40	11 000 033	RUBBER MOUNTING	25
201 323 56 40	11 000 034	RUBBER MOUNTING	26
201 330 00 51	13 981 011	WHEEL BEARING KIT	34
201 330 00 75	13 331 675	CONTROL ARM KIT	99
201 330 01 51	13 981 012	WHEEL BEARING KIT	34
201 330 02 51	13 981 013	WHEEL BEARING KIT	34
201 351 27 42	13 351 742	CONTROL ARM BUSHING	95
201 410 05 81	11 000 035	PROPELLER SHAFT MOUNTING	18
201 410 07 15	11 410 018	FLEXIBLE DISC KIT	14
201 410 10 15	11 000 036	FLEXIBLE DISC KIT	13
201 460 00 50	14 460 050	REP. KIT, STEERING ARM	21
201 460 01 04	14 460 104	LOCK CYLINDER	102
201 492 01 16	11 000 037	RUBBER MOUNTING	26
201 500 29 03	11 500 003	RADIATOR	157
201 500 46 03	11 500 603	RADIATOR	159
201 540 03 17	13 540 031	BRAKE WEAR INDICATOR	45
201 540 37 45	15 540 745	RELAY	182
201 545 00 14	15 545 014	REVERSE LIGHT SWITCH	183
201 820 36 42	18 820 643	WIPER MOTOR	86
201 820 45 42	18 820 943	BLOWER MOTOR	63
201 830 00 83	11 831 083	DRYER BOTTLE	134
201 830 12 70	11 832 870	CONDENSOR	131
201 830 22 70	11 832 770	CONDENSOR	131
201 830 28 70	11 832 970	CONDENSOR	131

Umschlüsselung OEM / Cross Reference OEM

DB	AL-HU TECH	Description	Page
201 880 01 14	11 880 001	CLIP, BUMPER	66
201 990 00 50	11 880 008	NUT, BUMPER	72
202 240 04 18	11 240 021	ENGINE MOUNTING	9
202 240 16 17	11 000 038	ENGINE MOUNTING	4
202 240 17 17	11 000 039	ENGINE MOUNTING	4
202 240 28 17	11 000 040	ENGINE MOUNTING	4
202 300 01 30	11 300 130	ACCELERATION CABLE	107
202 323 02 85	11 000 041	STABILIZER MOUNTING	29
202 330 00 75	13 331 075	CONTROL ARM KIT	97
202 333 64 14	11 000 042	RUBBER MOUNTING	26
202 350 34 08	11 000 043	REPAIR KIT, AXLE BODY	20
202 352 01 65	11 352 165	CONTROL ARM BUSHING	94
202 410 04 81	11 410 481	PROPELLER SHAFT MOUNTING	18
202 410 05 81	11 410 581	PROPELLER SHAFT MOUNTING	18
202 410 10 15	11 410 020	FLEXIBLE DISC KIT	14
202 410 11 15	11 410 021	FLEXIBLE DISC KIT	15
202 410 12 15	11 410 024	FLEXIBLE DISC KIT	15
202 410 13 15	11 410 022	FLEXIBLE DISC KIT	15
202 411 03 15	11 410 025	FLEXIBLE DISC KIT	16
202 411 06 15	11 410 026	FLEXIBLE DISC KIT	16
202 460 03 19	14 460 319	REP. KIT, STEERING ARM	21
202 460 04 05	10 000 027	DRAG LINK	99
202 460 07 04	14 460 040	LOCK CYLINDER	101
202 460 11 04	14 460 140	LOCK CYLINDER	102
202 500 02 49	11 500 249	EXPANSION TANK	136
202 500 06 49	11 500 646	EXPANSION TANK	137
202 505 21 55	11 501 355	FAN SHROUD	152
202 540 07 17	13 540 717	BRAKE WEAR INDICATOR	50
202 540 21 44	15 226 144	STEERING COLUMN SWITCH	186
202 540 26 17	13 756 617	ABS SENSOR	42
202 545 01 14	29 545 114	REVERSE LIGHT SWITCH	183
202 680 00 25	18 680 025	BONNET INSULATION	65
202 720 15 46	18 724 546	WINDOW LIFTER	77
202 720 16 46	18 724 646	WINDOW LIFTER	77
202 730 13 46	18 734 346	WINDOW LIFTER	81
202 730 14 46	18 734 446	WINDOW LIFTER	82
202 820 03 08	18 821 143	WIPER MOTOR	87
202 820 04 08	18 820 743	WIPER MOTOR	86
202 820 23 08	18 820 308	WIPER MOTOR	85
202 820 24 08	16 820 408	WIPER MOTOR	84
202 820 25 10	18 210 251	BLOWER REGULATOR	178
202 820 39 10	15 821 910	SWITCH, CENTRAL DOOR LOCK	187
202 820 40 10	15 821 910	SWITCH, CENTRAL DOOR LOCK	187
202 820 53 42	18 821 342	WIPER MOTOR	87
202 820 64 42	16 820 442	WIPER MOTOR	84
202 820 92 42	18 820 001	BLOWER MOTOR	62
202 820 93 42	18 820 342	BLOWER MOTOR	62
202 830 01 84	11 830 002	EXPANSION VALVE	139
202 830 02 83	11 830 013	DRYER BOTTLE	132
202 830 05 70	11 831 670	CONDENSOR	129
202 830 08 70	11 831 670	CONDENSOR	129
202 830 09 70	11 830 070	CONDENSOR	126
202 830 10 70	11 830 870	CONDENSOR	128
202 869 00 21	18 869 621	WINDSHIELD WASHER PUMP	83

Umschlüsselung OEM / Cross Reference OEM

DB	AL-HU TECH	Description	Page
202 869 01 21	18 869 621	WINDSHIELD WASHER PUMP	83
202 980 00 16	13 980 016	WHEEL BEARING KIT	31
202 980 00 16	13 981 014	WHEEL BEARING KIT	35
202 980 01 16	13 981 015	WHEEL BEARING KIT	35
202 997 01 86	11 880 007	CLIP, BUMPER	67
203 240 05 17	11 000 044	ENGINE MOUNTING	4
203 240 06 17	11 240 008	ENGINE MOUNTING	6
203 320 25 89	10 000 017	STABILIZER LINK	28
203 330 00 51	13 981 016	WHEEL BEARING KIT	35
203 330 01 11	11 330 003	CONTROL ARM	89
203 330 02 11	11 330 004	CONTROL ARM	89
203 330 19 11	11 330 005	CONTROL ARM	89
203 330 33 11	11 330 005	CONTROL ARM	89
203 330 34 11	11 330 006	CONTROL ARM	89
203 333 09 14	11 352 166	CONTROL ARM BUSHING	94
203 500 00 49	11 500 849	EXPANSION TANK	137
203 500 08 54	11 831 970	CONDENSOR	129
203 500 10 54	11 831 870	CONDENSOR	129
203 500 12 54	11 830 254	CONDENSOR	126
203 540 00 53	11 540 253	SPACER	162
203 540 01 53	11 540 253	SPACER	162
203 540 02 53	11 540 253	SPACER	162
203 540 13 17	13 756 317	ABS SENSOR	40
203 540 14 17	13 756 318	ABS SENSOR	40
203 887 01 27	11 880 004	HANDLE, BONNET RELEASE	68
203 887 04 27	11 880 004	HANDLE, BONNET RELEASE	68
204 500 05 49	63 451 439	EXPANSION TANK	139
204 540 01 17	13 753 008	ABS SENSOR	39
208 323 01 40	11 352 167	STABILIZER BUSHING	27
208 545 00 10	15 226 146	STEERING COLUMN SWITCH	186
210 240 01 17	11 240 009	ENGINE MOUNTING	6
210 240 02 17	11 240 010	ENGINE MOUNTING	6
210 240 05 18	15 240 018	ENGINE MOUNTING	11
210 240 20 17	11 240 029	ENGINE MOUNTING	11
210 320 36 89	13 320 689	STABILIZER LINK	28
210 320 37 89	13 320 789	STABILIZER LINK	29
210 330 00 51	13 981 017	WHEEL BEARING KIT	35
210 330 04 75	13 331 475	CONTROL ARM KIT	98
210 330 87 07	11 330 001	CONTROL ARM	88
210 330 88 07	11 330 002	CONTROL ARM	88
210 333 68 14	11 352 168	CONTROL ARM BUSHING	94
210 338 04 15	13 338 415	BALL JOINT	88
210 350 16 06	13 350 206	CONTROL ARM	93
210 350 17 06	13 350 206	CONTROL ARM	93
210 350 18 53	13 350 753	TIE ROD	106
210 350 24 06	13 350 206	CONTROL ARM	93
210 350 25 06	13 350 206	CONTROL ARM	93
210 350 34 06	13 350 206	CONTROL ARM	93
210 350 58 08	11 352 170	REPAIR KIT, AXLE BODY	20
210 351 08 42	11 000 045	RUBBER MOUNTING	26
210 357 00 91	63 451 426	BOOT KIT	2
210 357 01 91	63 451 426	BOOT KIT	2
210 410 08 15	11 410 023	FLEXIBLE DISC KIT	15
210 410 11 15	11 410 029	FLEXIBLE DISC KIT	17

## Umschlüsselung OEM / Cross Reference OEM

DB	AL-HU TECH	Description	Page
210 410 12 15	11 410 027	FLEXIBLE DISC KIT	16
210 411 05 15	11 410 028	FLEXIBLE DISC KIT	16
210 428 00 35	10 000 005	BRAKE HOSE	43
210 460 00 61	17 460 001	GASKET SET STEERING PUMP	100
210 460 23 00	63 451 427	STEERING BELLOW	29
210 500 05 49	11 501 549	EXPANSION TANK	138
210 501 07 15	12 018 304	RADIATOR CAP	159
210 540 00 45	11 540 524	SENSOR, COOLANT LEVEL	185
210 540 01 44	15 226 044	STEERING COLUMN SWITCH	186
210 540 06 17	13 756 217	ABS SENSOR	40
210 540 07 17	11 540 717	ABS SENSOR	38
210 540 11 17	13 540 111	BRAKE WEAR INDICATOR	47
210 540 90 08	11 540 008	ABS SENSOR	38
210 540 91 08	11 540 108	ABS SENSOR	38
210 545 00 24	11 540 024	SENSOR, COOLANT LEVEL	184
210 682 02 26	18 680 126	HOOD PAD	71
210 720 01 16	18 720 116	DOOR STOP	67
210 720 11 46	18 720 046	WINDOW LIFTER	73
210 720 12 46	18 720 146	WINDOW LIFTER	74
210 730 15 46	18 730 546	WINDOW LIFTER	78
210 730 16 46	18 730 646	WINDOW LIFTER	78
210 820 01 10	15 820 111	WINDOW LIFTER SWITCH	191
210 820 17 42	18 820 043	WIPER MOTOR	84
210 820 18 42	18 820 543	WIPER MOTOR	86
210 820 24 42	18 820 442	BLOWER MOTOR	63
210 820 62 10	18 820 210	BLOWER REGULATOR	179
210 821 15 51	11 821 551	BLOWER REGULATOR	177
210 821 16 51	11 821 651	BLOWER REGULATOR	177
210 830 02 70	11 831 570	CONDENSOR	128
210 830 03 70	11 830 770	CONDENSOR	128
210 830 03 83	11 830 283	DRYER BOTTLE	133
210 830 04 83	11 830 883	DRYER BOTTLE	134
210 830 05 70	11 831 570	CONDENSOR	128
210 830 05 72	15 830 772	SENDER UNIT	184
210 830 07 72	15 830 772	SENDER UNIT	184
210 830 09 58	11 830 958	EVAPORATOR	135
210 869 08 21	18 869 421	WINDSHIELD WASHER PUMP	83
210 869 10 21	18 869 521	WINDSHIELD WASHER PUMP	83
211 333 10 14	11 352 169	CONTROL ARM BUSHING	95
211 500 00 49	11 501 949	EXPANSION TANK	138
211 500 01 54	11 832 270	CONDENSOR	130
211 540 07 17	13 540 071	BRAKE WEAR INDICATOR	46
211 540 23 17	13 756 319	ABS SENSOR	41
211 540 24 17	13 756 320	ABS SENSOR	41
211 835 00 47	11 830 014	DRYER BOTTLE	133
220 240 02 18	11 240 028	ENGINE MOUNTING	11
220 240 06 17	11 240 012	ENGINE MOUNTING	7
220 240 07 17	11 240 013	ENGINE MOUNTING	7
220 271 03 80	12 271 280	TRANSMISSION FILTER GASKET	60
220 330 07 25	13 981 018	WHEEL BEARING KIT	36
220 330 57 11	11 330 009	CONTROL ARM	90
220 330 58 11	11 330 010	CONTROL ARM	90
220 330 83 07	11 330 007	CONTROL ARM	90
220 330 84 07	11 330 008	CONTROL ARM	90

Umschlüsselung OEM / Cross Reference OEM

DB	AL-HU TECH	Description	Page
220 330 89 07	11 330 012	CONTROL ARM	91
220 330 90 07	11 330 011	CONTROL ARM	91
220 330 91 07	13 330 107	LINK REPAIR KIT	17
220 330 93 07	11 330 007	CONTROL ARM	90
220 330 94 07	11 330 008	CONTROL ARM	90
220 500 00 49	11 500 049	EXPANSION TANK	136
220 500 00 93	11 500 001	BLOWER MOTOR	121
220 501 00 82	11 500 010	RADIATOR HOSE	159
220 501 03 82	18 501 003	RADIATOR HOSE	160
220 501 04 82	18 501 004	RADIATOR HOSE	160
220 540 01 17	13 756 117	ABS SENSOR	40
220 540 04 17	13 756 417	ABS SENSOR	41
220 540 05 17	13 756 517	ABS SENSOR	41
220 540 06 17	13 540 617	BRAKE WEAR INDICATOR	50
220 540 07 17	13 540 617	BRAKE WEAR INDICATOR	50
220 540 15 17	13 540 517	BRAKE WEAR INDICATOR	49
220 545 00 10	15 227 144	STEERING COLUMN SWITCH	187
220 720 03 46	18 720 546	WINDOW LIFTER	74
220 720 04 46	18 720 646	WINDOW LIFTER	75
220 720 25 46	18 720 746	WINDOW LIFTER	75
220 720 26 46	18 720 846	WINDOW LIFTER	75
220 730 03 46	18 731 546	WINDOW LIFTER	79
220 730 04 46	18 731 646	WINDOW LIFTER	80
220 730 23 46	18 731 746	WINDOW LIFTER	80
220 730 24 46	18 731 846	WINDOW LIFTER	80
220 820 07 42	16 820 002	WIPER MOTOR	84
220 820 92 10	18 210 921	BLOWER REGULATOR	179
220 830 00 83	11 830 083	DRYER BOTTLE	133
220 830 03 84	11 830 008	EXPANSION VALVE	140
220 830 10 58	11 831 058	EVAPORATOR	135
220 887 02 27	11 880 005	HANDLE, BONNET RELEASE	68
220 980 00 16	13 981 019	WHEEL BEARING KIT	36
220 980 01 16	13 981 020	WHEEL BEARING KIT	36
221 500 03 49	11 500 051	EXPANSION TANK	136
230 330 03 25	13 981 023	WHEEL HUB	37
230 830 01 84	11 830 001	EXPANSION VALVE	139
266 202 00 19	11 200 024	BELT TENSIONER PULLEY	117
271 200 02 01	18 200 016	WATER PUMP	172
271 200 02 70	11 206 270	BELT TENSIONER	115
272 200 02 70	11 200 271	BELT TENSIONER	112
272 202 10 19	11 200 008	BELT TENSIONER PULLEY	116
272 202 14 19	11 200 272	BELT TENSIONER PULLEY	118
435 542 00 17	13 542 017	BRAKE WEAR INDICATOR	51
460 540 06 17	13 540 061	BRAKE WEAR INDICATOR	46
601 094 03 91	11 094 091	BOOT	124
601 200 00 15	11 203 003	THERMOSTAT	166
601 200 03 23	11 200 323	FAN BLADE	142
601 200 04 23	11 202 423	FAN BLADE	141
601 200 07 70	11 200 770	BELT TENSIONER PULLEY	119
601 200 09 20	18 200 017	WATER PUMP	172
601 200 09 70	11 200 970	BELT TENSIONER PULLEY	120
601 200 10 70	11 200 170	BELT TENSIONER PULLEY	118
601 200 12 70	11 200 005	BELT TENSIONER PULLEY	116
601 200 17 73	11 201 870	BELT TENSIONER LEVER	115



Umschlüsselung OEM / Cross Reference OEM

DB	AL-HU TECH	Description	Page
601 350 00 68	13 981 021	WHEEL BEARING KIT	36
601 350 01 68	13 981 021	WHEEL BEARING KIT	36
601 350 02 68	13 981 021	WHEEL BEARING KIT	36
601 350 04 68	13 981 021	WHEEL BEARING KIT	36
601 540 06 17	13 540 062	BRAKE WEAR INDICATOR	46
601 540 13 17	13 540 131	BRAKE WEAR INDICATOR	48
601 981 00 27	11 981 027	BUSHING,TENSIONER PULLEY DRIVE	124
602 200 01 22	11 204 122	FAN CLUTCH	151
602 200 04 23	11 201 423	FAN BLADE	143
602 321 02 50	11 000 046	STABILIZER MOUNTING	29
603 200 00 22	11 200 002	FAN CLUTCH	145
603 200 04 23	11 200 423	FAN BLADE	142
603 200 05 22	11 201 522	FAN CLUTCH	148
603 200 05 23	11 200 523	FAN BLADE	140
603 200 06 22	11 203 622	FAN CLUTCH	151
604 150 06 60	11 200 025	PULLEY	157
604 200 00 22	11 202 022	FAN CLUTCH	149
604 200 01 23	11 200 123	FAN BLADE	141
606 200 01 22	11 200 033	FAN CLUTCH	146
606 202 01 20	11 201 570	BEARING JOURNAL	111
611 094 00 48	11 095 248	AIR MASS SENSOR	111
611 155 02 15	11 200 006	BELT TENSIONER PULLEY	116
611 155 04 15	11 200 026	PULLEY	157
611 155 07 15	11 200 007	PULLEY	156
611 200 02 15	21 200 215	THERMOSTAT HOUSING	167
611 200 03 15	11 200 315	THERMOSTAT with housing	167
611 200 03 70	11 202 270	BELT TENSIONER	114
611 200 05 15	11 200 315	THERMOSTAT with housing	167
611 200 05 70	11 202 270	BELT TENSIONER	114
611 200 07 15	21 200 215	THERMOSTAT HOUSING	167
611 200 10 01	18 200 057	WATER PUMP	175
611 200 11 01	18 200 058	WATER PUMP	175
611 200 12 01	18 201 120	WATER PUMP	176
611 330 07 25	13 981 001	WHEEL BEARING KIT	32
613 200 00 22	11 200 034	FAN CLUTCH	146
616 200 03 22	11 203 322	FAN CLUTCH	151
617 200 07 20	11 200 072	WATER PUMP	168
631 428 00 35	10 000 004	BRAKE HOSE	43
638 720 00 46	18 719 046	WINDOW LIFTER	72
638 720 00 46	18 719 246	WINDOW LIFTER	72
638 720 01 46	18 719 146	WINDOW LIFTER	72
638 720 01 46	18 719 346	WINDOW LIFTER	73
638 835 01 70	11 832 370	CONDENSOR	130
639 540 14 17	13 540 835	BRAKE WEAR INDICATOR	50
639 540 15 17	13 540 517	BRAKE WEAR INDICATOR	49
640 202 04 19	11 200 027	BELT TENSIONER PULLEY	117
646 200 02 70	11 202 270	BELT TENSIONER	114
646 200 03 01	18 200 059	WATER PUMP	175
669 540 04 17	13 540 041	BRAKE WEAR INDICATOR	46
669 540 07 17	13 540 073	BRAKE WEAR INDICATOR	47
669 540 08 17	13 540 081	BRAKE WEAR INDICATOR	47
669 540 09 17	13 540 917	BRAKE WEAR INDICATOR	51
670 540 00 17	13 540 001	BRAKE WEAR INDICATOR	45
677 540 07 17	13 540 072	BRAKE WEAR INDICATOR	47

## Umschlüsselung OEM / Cross Reference OEM

DB	AL-HU TECH	Description	Page
901 300 10 30	21 300 030	ACCELERATION CABLE	109
901 300 16 30	21 301 030	ACCELERATION CABLE	109
901 300 17 30	21 301 030	ACCELERATION CABLE	109
901 462 03 79	14 462 327	LOCK CYLINDER	71
901 500 05 54	11 831 770	CONDENSOR	129
901 540 00 17	13 540 117	BRAKE WEAR INDICATOR	48
901 540 01 17	13 540 117	BRAKE WEAR INDICATOR	48
901 540 02 17	13 540 021	BRAKE WEAR INDICATOR	45
901 540 03 17	13 540 021	BRAKE WEAR INDICATOR	45
901 542 08 17	13 927 001	ABS SENSOR	42
901 542 11 17	13 927 002	ABS SENSOR	43
901 542 17 17	13 927 001	ABS SENSOR	42
901 760 04 59	28 760 459	HANDLE, DOOR AND SLIDING DOOR	69
901 760 13 61	18 760 361	DOOR HANDLE	67
902 350 00 68	13 981 022	WHEEL BEARING KIT	37
906 500 00 54	21 830 054	CONDENSOR	131
906 540 13 17	13 540 320	BRAKE WEAR INDICATOR	49
906 540 14 17	13 540 838	BRAKE WEAR INDICATOR	50
906 540 15 17	13 540 838	BRAKE WEAR INDICATOR	50

**Garantie**

Alle ALHU-tech-Produkte sind im Bezug auf Materialfehler und Fertigungsmängel garantiert. Diese Garantie beschränkt sich ausschließlich auf den Ersatz des fehlerhaften Bestandteils. Wir übernehmen keine Haftung für Schäden, die sich aufgrund von Missbrauch, Vernachlässigung, Unfall, Abnutzung und Verschleiß ergeben. Alle Verluste und Folgeschäden sind ausdrücklich ausgeschlossen. Forderungen bezüglich Schäden oder Unstimmigkeiten hinsichtlich von Produktlieferungen der Firma ALHU Fahrzeugtechnik GmbH sind unmittelbar und schriftlich vorzulegen. Dieser Katalog enthält das komplette ALHU-tech-Programm an Automobil-Elektroteilen und dient als Leitfaden der möglichen Einsatzbereiche. Obwohl wir bei der Erstellung dieser Angaben höchste Sorgfalt angewandt haben, können wir keine Gewähr für die absolute Richtigkeit der Informationen abgeben. Technische und konstruktive Produktänderungen können im Laufe der Gültigkeit dieses Katalogs erforderlich sein, so dass sich möglicherweise Unterschiede zwischen den ursprünglichen Abbildungen und tatsächlich gelieferten Produkten ergeben.

**Guarantee**

All ALHU-tech products are guaranteed against defects arising from faulty materials or workmanship. The guarantee is limited to the replacement of the faulty part; we cannot extend the guarantee to cover defects caused by misuse, neglect, accident or wear and tear. We cannot accept liability for consequential loss or damage which is claimed to have resulted from use of one of our products. Claims resulting from damage or discrepancies during delivery of goods from ALHU Fahrzeugtechnik GmbH must be made without delay and reported in writing. This catalogue shows the range of ALHU-tech auto-electrical parts and is a guide to the vehicles to which they apply. Whilst great care has been taken in the preparation of the catalogue we cannot guarantee the complete accuracy of this information. In some instances technical and design changes may be necessary during the life of this catalogue which may result in some difference between the original illustrations and products currently supplied.

**Garantie**

Toutes les pièces ALHU-tech figurant dans ce catalogue sont garanties contre tout vice de fabrication. La garantie est limitée au remplacement du produit défectueux; la garantie ne couvre pas des défauts résultants d'abus, négligence, accident ou usure. Nous ne pouvons pas accepter la responsabilité pour des pertes ou dégâts résultants de l'emploi de nos produits. Les réclamations résultants de produit endommagé ou manquant au livraison doivent être communiquées sans délai et par écrit à ALHU Fahrzeugtechnik GmbH. Les références, numéros d'origine ou autres, étrangers aux numéros propres de ALHU-tech ne sont portés qu'à titre indicatif et ne peuvent en aucun cas donner matière à confusion. De temps en temps des modifications techniques peuvent être nécessaires, résultant dans des différences entre les illustrations et les produits fournis.

**Garanzia**

Tutti i prodotti ALHU-tech sono garantiti da difetti derivanti da materiali non conformi o da cattiva esecuzione. La garanzia è limitata alla sostituzione delle parti difettate; la garanzia non vale per difetti causati da utilizzo improprio, danni a usura. Non ci riteniamo responsabili per eventuali difetti o danni derivanti da un cattivo utilizzo dei nostri prodotti.

Eventuali reclami per danni o difetti causati durante il trasporto dalla ALHU Fahrzeugtechnik GmbH ci devono pervenire per tempo e per iscritto.

Il presente catalogo illustra la gamma delle parti elettriche delle automobili ALHU-tech ed è una guida per i veicoli a cui esse vanno applicate.

Nonostante il catalogo sia stato preparato con grande accuratezza, non garantiamo l'esattezza delle informazioni contenute.

Per alcuni modelli potrebbero essere necessarie delle modifiche o di design, perciò potrebbero riscontrarsi delle differenze tra le illustrazioni originarie ed i prodotti forniti dopo la distribuzione del catalogo.

**Garantia**

Todos os produtos da ALHU-tech tem garantia contra defeito de material ou de mau-de-obra. A garantia limita-se a troca da peça defeituosa e não podemos estender a garantia a defeitos provocados por mau uso, negligência, acidente ou desgaste. Também não podemos tomar a responsabilidade por qualquer perda ou dano que se pretenda tenha resultado do uso de qualquer dos nossos produtos. Reclamações sobre danos ou faltas na entrega, devem ser feitas o mais rápido possível e por escrito.

Este catálogo apresenta a gama de peças auto-eléctricas da ALHU-tech e, e um guia para os automóveis nas quais se aplicam. Embora tenha sido prestado o maior cuidado na compilação deste catálogo, não podemos garantir a sua completa exactitude.

Em alguns casos, alterações técnicas ou ilustrativas podem ser necessárias durante a existência deste catálogo, as quais poderão resultar em diferenças entre as ilustrações e os produtos fornecidos actualmente.

**Garantía**

Todos los productos de ALHU-tech estan garantizados contra defectos de material o de mano de obra - la garantía se limita al cambio de la pieza defectuosa, no podemos extender la garantía a defectos causados por mal uso, negligencia, accidente o desgaste - tampoco podemos aceptar responsabilidad por cualquier pérdida o daño que se pretenda haya resultado en el uso de cualquiera de nuestros productos. Reclamaciones, sobre daños o faltas en las entregas, deberan hacerse sin pérdida de tiempo y por escrito.

Este catálogo muestra la gama de las piezas autoeléctricas de ALHU-tech y es una guía para los automóviles a los cuales se aplican. Si bien se ha prestado mucha atención, no podemos garantizar su completa exactitud.

En algunos casos, cambios técnicos o en el diseño, pueden ser necesarios durante la existencia de este catálogo, lo cual puede resultar en diferencias entre las ilustraciones y los productos suministrados actualmente.

## **Auszug aus unseren Allgemeinen Lieferungs- und Garantiebedingungen.**

Gültig für Angebote, Verkäufe und Lieferungen.

Angebote sind freibleibend und ohne Verbindlichkeit für uns. Wenn nicht anders vereinbart, verstehen sich alle Preise netto, ab Werk einschließlich Verpackung.

Es werden die am Tage der Lieferung gültigen Preise berechnet. Bei Sonderanfertigungen sind Ober- oder Unterlieferungen bis zu 10% der bestellten Menge zulässig.

Mängelrügen gegen Gewicht, Stückzahl, Güte oder Ausführung der Ware können nur berücksichtigt werden, wenn sie unverzüglich mitgeteilt werden. Wir garantieren für gute Qualität und sorgfältige Ausführung der gelieferten Ware auf die Dauer von zwölf Monaten (ab Versanddatum gerechnet). Diese Garantie erstreckt sich auf Material- und Fabrikationsfehler, die sich im Laufe dieses Zeitabschnittes zeigen. Wir verpflichten uns, während der Dauer der Garantie defekte Teile kostenlos instand zu setzen, zu ersetzen oder zu vergüten.

Unsere Garantie erstreckt sich nicht über den natürlichen Verschleiß von Bestandteilen sowie Schäden noch deren Folgen, welche durch falsche Bedienung, Nachlässigkeit, übermäßige Beanspruchung verursacht werden. Unsere gesamte Garantie erlischt sofort, wenn Änderungen oder Reparaturen ohne Zustimmung vorgenommen werden. Zeichnungen, Unterlagen und Entwürfe unserer Firma dürfen vom Empfänger irgendwelchen dritten Personen nicht bekannt gegeben werden.

Sämtliche Angaben dieses Kataloges sind mit größter Sorgfalt zusammengestellt worden, und sind - soweit wir feststellen können - richtig. Irgendwelche Ersatzansprüche aufgrund unserer Katalogangaben können jedoch nicht anerkannt werden. Hinweise auf Fehler sind uns stets willkommen.

### **Nachdruck**

Auch auszugsweise nicht gestattet: Alle Rechte, insbesondere die der Vervielfältigung, sowie der Speicherung auf Datenträgern - auch auszugsweise - bleiben vorbehalten.

### **Wichtiger Hinweis**

Teile-Nummern anderer Hersteller sind ausschließlich zu Vergleichszwecken aufgeführt. Diese dürfen in Rechnungen an Endverbraucher nicht verwendet werden.

ALHU Fahrzeugtechnik GmbH, D-22301 Hamburg