

truck and bus spare parts for

MAN

Achse / Axle

21 524 005 ABS PULSE WHEEL

MAN
81.52403.6005



63 450 155 AIR SPRING BASE

TGA

MAN
81.43603.0044



63 450 183 AIR SPRING BASE

MAN
81.43603.0062



63 450 184 AIR SPRING BASE

F 2000

MAN
81.43603.0041



Achse / Axle

63 450 185 AIR SPRING BASE

MAN
81.43603.0055



63 450 186 AIR SPRING BASE

MAN
81.43603.0060



63 450 570 AIR SPRING BASE

MAN
81.43603.0047



23 350 447 AXLE ROD MOUNTING

MAN
81.96210.0447



Achse / Axle

23 350 448 AXLE ROD MOUNTING

MAN
81.96210.0448



21 401 019 BALL BEARING

MAN 06.32489.0051 **FAG** 32018

Mercedes Benz
004 981 43 05



21 981 001 BALL BEARING

MAN 06.32489.0041 **FAG** 33210

Mercedes Benz **ZF**
002 981 79 05 0750 117 209



21 981 004 BALL BEARING
37X74X45

MAN
51.93410.0119

BMW
33 41 1 123 415



Achse / Axle

63 451 331 BALL BEARING

MAN
06.32499.0058



63 451 332 BALL BEARING

MAN
06.32499.0108



23 330 133 BALL JOINT REPAIR KIT

MAN
81.95301.6133



23 330 706 BALL JOINT REPAIR KIT

MAN
81.95301.6132

Volvo
273706

LMI
1177101



Achse / Axle

23 331 009 BALL JOINT REPAIR KIT

MAN
81.43315.0009



23 350 001 BALL JOINT REPAIR KIT

TGA TGS TGX

MAN
81.43220.6285



23 350 002 BALL JOINT REPAIR KIT

MAN
85.43220.6002

Mercedes Benz
000 330 20 11



23 350 003 BALL JOINT REPAIR KIT

MAN
81.43270.6100



Achse / Axle

23 350 004 BALL JOINT REPAIR KIT

TGA

MAN
81.43270.6072



23 350 009 BALL JOINT REPAIR KIT

L 2000

MAN
81.43250.6009



23 350 010 BALL JOINT REPAIR KIT

MAN
81.43270.6080



23 350 011 BALL JOINT REPAIR KIT

MAN
81.43270.6133



Achse / Axle

23 350 012 BALL JOINT REPAIR KIT

MAN
81.95302.0077



23 350 013 BALL JOINT REPAIR KIT

MAN
81.96401.0152

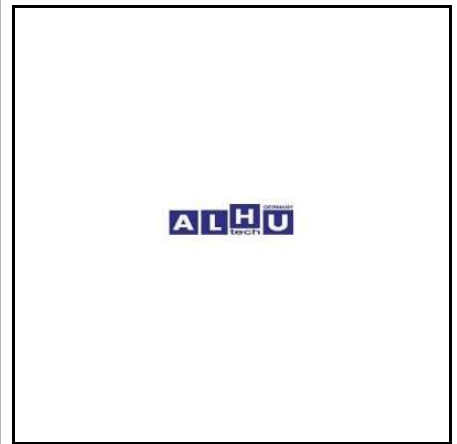

23 350 015 BALL JOINT REPAIR KIT

MAN
81.43220.6203

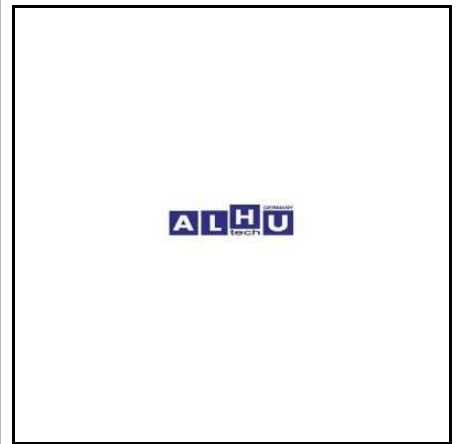

23 350 043 BALL JOINT REPAIR KIT

MAN
81.43230.6043

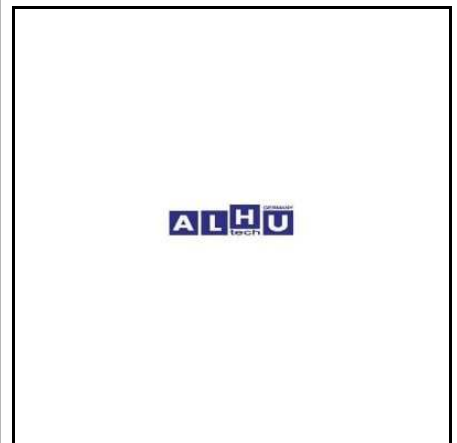

Achse / Axle

23 350 051 BALL JOINT REPAIR KIT

MAN 81.43230.6051	Scania 550806
Mercedes Benz 000 330 07 07	Volvo 271187



23 350 065 BALL JOINT REPAIR KIT

L 2000 M 2000

MAN
81.43270.6065



23 350 079 BALL JOINT REPAIR KIT

TGA

MAN
81.43270.6079



23 350 106 BALL JOINT REPAIR KIT

TGA TGS TGX

MAN
81.43270.6105

Mercedes Benz
000 350 28 05



Achse / Axle

23 350 107 BALL JOINT REPAIR KIT

MAN 81.43220.6107 81.95302.0059	Scania 638862
Mercedes Benz 000 330 06 11	



23 350 108 BALL JOINT REPAIR KIT

MAN 81.43220.6108	
-----------------------------	--



23 350 109 BALL JOINT REPAIR KIT

MAN 81.43220.6073	
Mercedes Benz 000 350 05 06	



23 350 113 BALL JOINT REPAIR KIT

MAN 81.43220.6202	Scania 550812 639319
LMI 1967701	Volvo 275988



Achse / Axle

23 350 114 BALL JOINT REPAIR KIT

TGA

MAN
81.43220.6244



23 350 116 BALL JOINT REPAIR KIT

MAN
81.43230.6061

Mercedes Benz
000 330 02 07



23 350 117 BALL JOINT REPAIR KIT

MAN 81.43270.6040 **Iveco** 93192619

Mercedes Benz
000 350 04 13



23 350 204 BALL JOINT REPAIR KIT

S 2000

MAN
81.43220.6204

LMI
2526801



Achse / Axle

23 350 250 BALL JOINT REPAIR KIT

TGA

MAN
81.43220.6250

Mercedes Benz
000 350 15 13



23 350 905 BALL JOINT REPAIR KIT

TGA TGS TGX

MAN
81.43270.6110

Mercedes Benz
000 350 24 05



23 352 505 BALL JOINT REPAIR KIT

MAN
81.43220.6322



63 451 066 BALL JOINT REPAIR KIT

MAN 81.43270.6091 **Scania** 1498132

Mercedes Benz
629 330 00 07



Achse / Axle

63 451 067 BALL JOINT REPAIR KIT

MAN
81.43270.6119

Volvo
20547286

Scania
1515981



63 451 343 BALL JOINT REPAIR KIT

MAN
81.43230.6060



63 451 344 BALL JOINT REPAIR KIT

MAN
81.43270.6047



63 451 365 BALL SOCKET

MAN
81.95301.0048



Achse / Axle

21 000 009 BEARING BUSH

MAN
06.36959.0027



24 420 014 BEARING BUSH

TGA TGS TGX

MAN
06.36959.0014

Mercedes Benz
000 981 60 31



63 450 193 BEARING BUSH

MAN
06.36950.0508

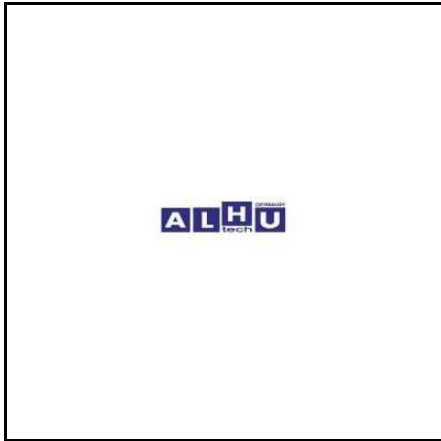

23 718 043 BEARING CAP

MAN
81.43718.0043

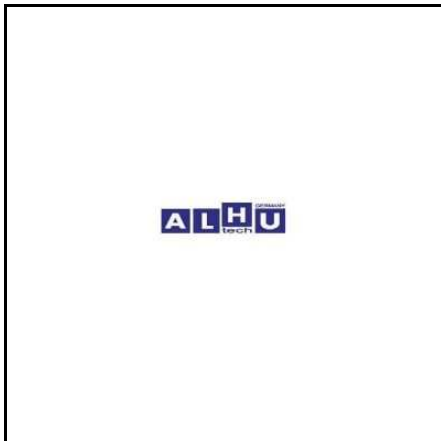

Achse / Axle

23 718 044 BEARING CAP

MAN
81.43718.0044



63 450 091 BELLOW

L 2000 M 2000

MAN
81.96420.0529



23 320 241 BRACKET

MAN
81.41301.0241



23 325 106 BRACKET

MAN
81.41301.5106



Achse / Axle

23 325 193 BRACKET

MAN
81.43705.0193



23 705 241 BRACKET
left

MAN
81.43705.0241



23 705 242 BRACKET
right

MAN
81.43705.0242



616708 BUSH

MAN
81.93021.0218

Mercedes Benz
653 353 00 50



Achse / Axle

63 451 364 BUSHING

MAN
81.93020.2315



23 323 344 CAB SUPPORT

MAN
81.41701.5344



23 323 345 CAB SUPPORT

MAN
81.41701.5345



63 450 087 CABIN MOUNTING

MAN
81.96210.0364



Achse / Axle

63 450 194 CABIN MOUNTING

MAN
81.96210.0603



23 320 002 CAP

MAN
81.41352.0002



23 323 009 CAP

MAN
81.41352.0009



21 990 501 CARDAN BOLT

MAN
81.90001.0174

Mercedes Benz
395 990 05 01



Achse / Axle

23 350 016 CONTROL ARM

MAN
81.43220.6190



23 350 017 CONTROL ARM

MAN
81.43220.6189



23 350 018 CONTROL ARM

MAN
81.43220.6185



23 350 058 CONTROL ARM

F 2000

MAN
81.43230.6058



Achse / Axle

23 350 076 CONTROL ARM	
	F 2000
<p>MAN 81.43270.6076</p>	



23 350 087 CONTROL ARM	
	F 2000
<p>MAN 81.43270.6087</p>	



23 350 092 CONTROL ARM	
<p>MAN 81.43220.6092</p>	
<p>LMI 1849501</p>	

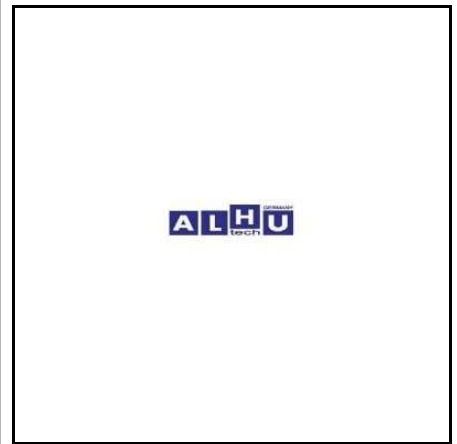

23 350 096 CONTROL ARM	
	TGA
<p>MAN 81.43270.6096</p>	

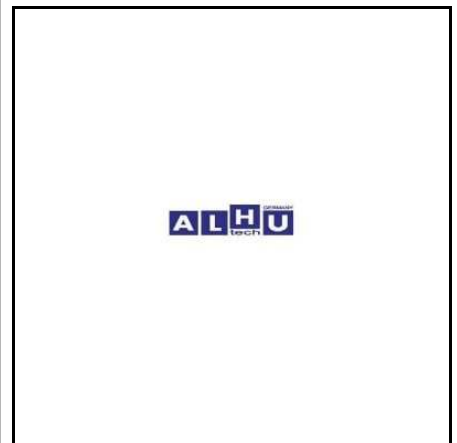

Achse / Axle

23 350 097 CONTROL ARM

F 2000

MAN
81.43220.6097
81.43220.6129

TA501
114 154

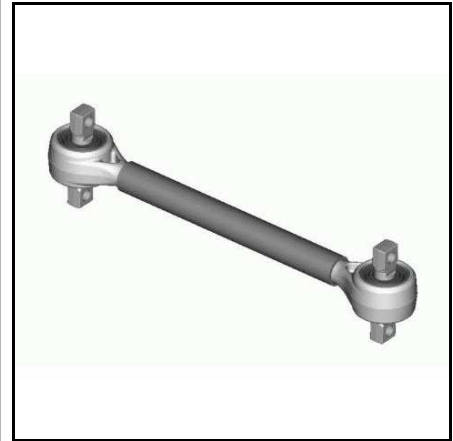

23 350 111 CONTROL ARM

MAN
81.43220.6183

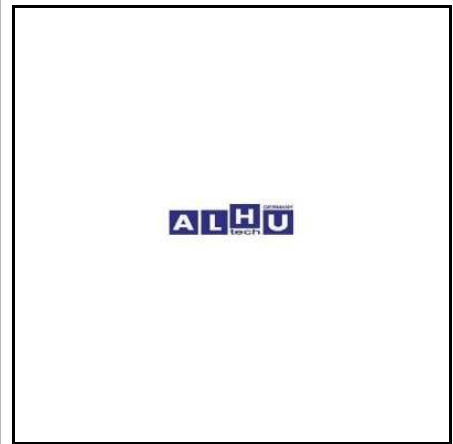

23 350 112 CONTROL ARM

F 2000

MAN
81.43220.6112



23 350 118 CONTROL ARM

MAN
81.43270.6077

Frimatec
114 279

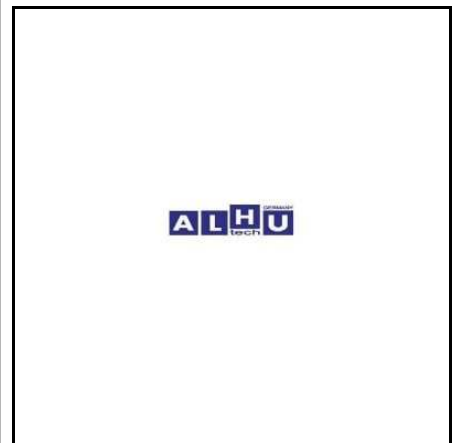

Achse / Axle

23 350 121 CONTROL ARM

MAN
81.43230.6037



23 350 125 CONTROL ARM

MAN
81.43220.6093



23 350 126 CONTROL ARM

MAN
81.43270.6137



23 350 128 CONTROL ARM

TGA TGX

MAN
81.43270.6117



Achse / Axle

23 350 137 CONTROL ARM

MAN
81.43220.6135
81.43220.6137



23 350 196 CONTROL ARM

F 2000

MAN
81.43220.6196

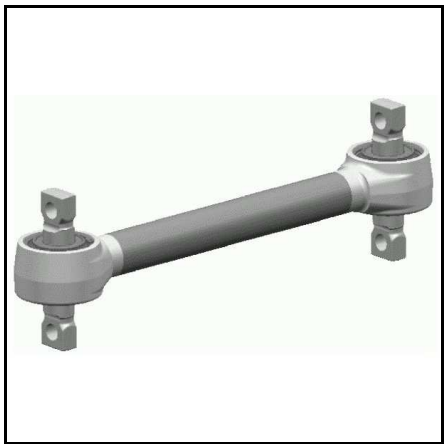

23 350 220 CONTROL ARM

MAN
81.43220.6220

LMI
2526701



23 350 229 CONTROL ARM

TGA TGX

MAN
81.43220.6229
81.43220.6268



Achse / Axle

23 350 236 CONTROL ARM

MAN
81.43220.6236
81.43220.9236

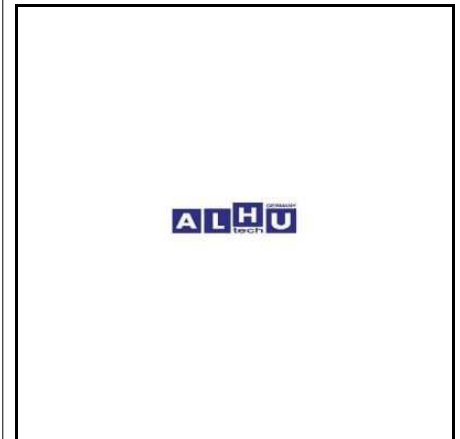

63 450 243 CONTROL ARM

MAN
81.43220.6215

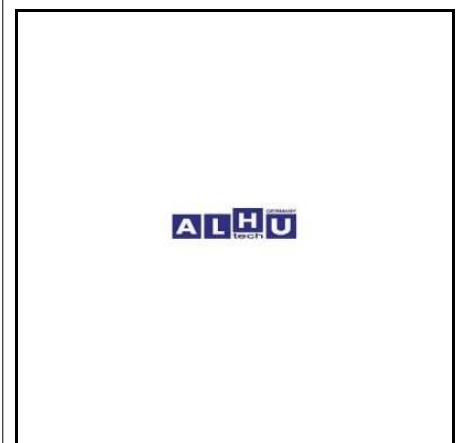

23 460 319 CONTROL ARM BUSHING

MAN
81.93001.0319

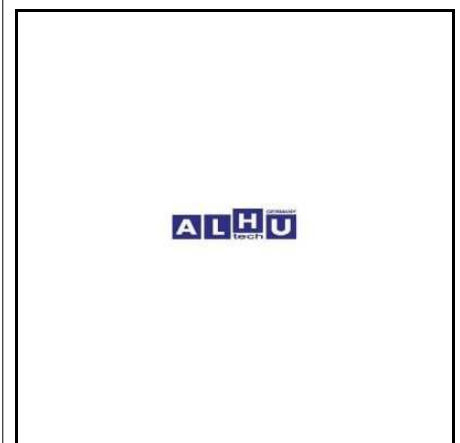

63 451 118 COVER

MAN
81.91605.0043

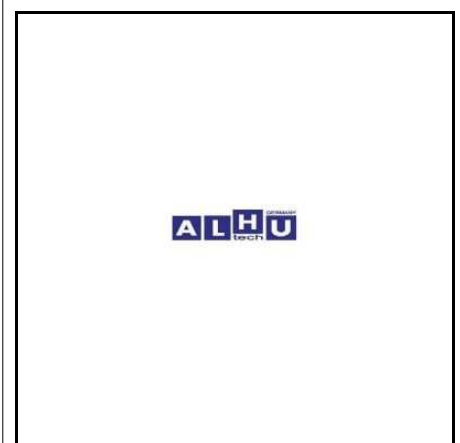

Achse / Axle

616702 DRIVE SHAFT

MAN
81.35611.0017

Mercedes Benz
355 353 09 35



21 115 567 DRIVING FLANGE

MAN
81.39115.5067

Mercedes Benz
355 350 12 45



63 450 013 DRIVING FLANGE

MAN
81.39115.5061



63 450 069 DRIVING FLANGE

MAN
81.39115.5068



Achse / Axle

63 450 103 DRIVING FLANGE

MAN
81.39115.0207

Mercedes Benz
355 353 22 45



63 450 686 DRIVING FLANGE

MAN
81.39115.5042



23 332 141 DUST COVER

F 2000

MAN
81.50101.5141



21 210 552 ENGINE MOUNTING

MAN
81.96210.0552



Achse / Axle

21 241 202 ENGINE MOUNTING

MAN
81.96020.0202



21 241 373 ENGINE MOUNTING

MAN
81.96210.0373

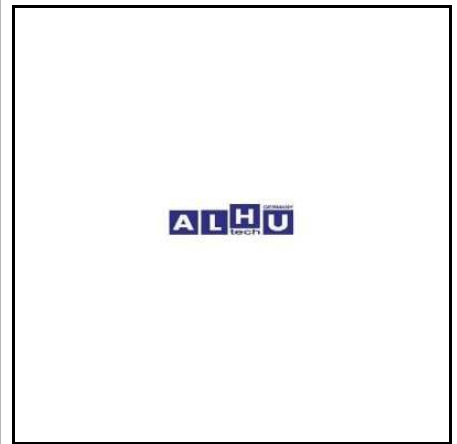

63 450 088 ENGINE MOUNTING

TGA

MAN
81.96210.0574

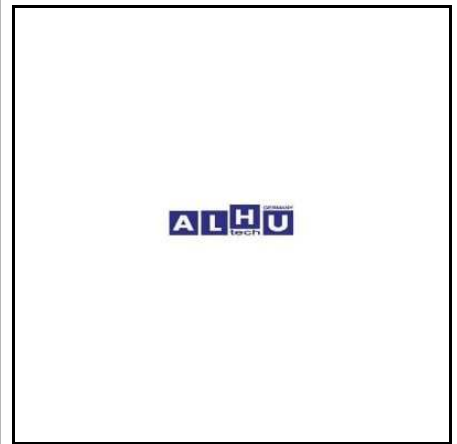

63 450 089 ENGINE MOUNTING

rear

TGA

MAN
81.96210.0597

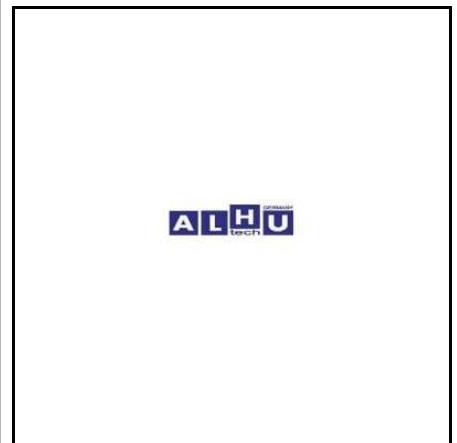

Achse / Axle

63 450 090 ENGINE MOUNTING
rear
TGA

MAN
81.96210.6072



63 450 541 ENGINE MOUNTING

MAN
81.96210.0367



63 451 121 ENGINE MOUNTING

MAN
81.96210.0302



63 453 048 ENGINE MOUNTING

MAN
81.96210.0023



Achse / Axle

63 453 050 ENGINE MOUNTING



MAN
81.96210.0238



21 350 445 FLANGE

MAN
81.39115.5030

Mercedes Benz
346 350 04 45



21 601 298 GASKET
APL axle

MAN
81.96601.0298

Mercedes Benz
650 356 01 80



63 451 393 GASKET

MAN
85.96501.0002



Achse / Axle

23 324 004 GLIDER PLATE

MAN
81.41405.0004



23 324 012 GLIDER PLATE

MAN
81.41405.0012



11.020.0805.19 HEX COLLAR NUT, black

MAN
81.45503.0047



63 450 323 HEX SHOULDER STUD

MAN
06.01494.7317



Achse / Axle

21 114 086 HUB CAP

MAN
81.35114.0086

Mercedes Benz
624 356 00 20



21 334 025 HUB CAP

MAN
81.44312.0003

Mercedes Benz
389 334 00 25



63 450 003 INTERMEDIATE BEARING

MAN
81.39410.6028



616706 KING PIN BUSHING

MAN
81.93020.0678

Mercedes Benz
355 353 09 50



Achse / Axle

616707 KING PIN BUSHING

MAN
81.93020.0679

Mercedes Benz
355 353 10 50

**21 330 001 KING PIN SET**

MAN
81.36305.6004

**21 330 004 KING PIN SET**

MAN
81.44205.6010

**21 330 005 KING PIN SET**

MAN
81.44205.6011



Achse / Axle

21 330 006 KING PIN SET

MAN
81.44205.6012



21 330 007 KING PIN SET

L 2000 M 2000

MAN
81.44205.6019



21 330 008 KING PIN SET

L 2000

MAN
81.44205.6020



21 330 033 KING PIN SET

TGL

MAN
81.44205.6033



Achse / Axle

23 330 009 KING PIN SET

MAN
81.44205.6009

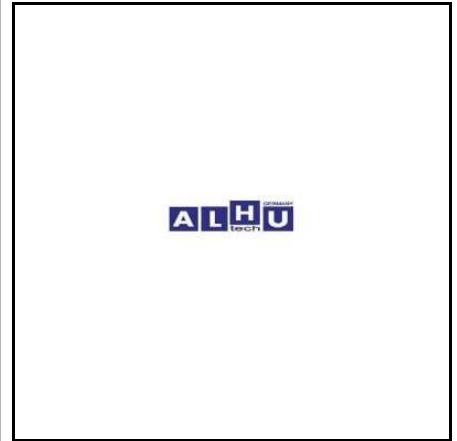

23 330 010 KING PIN SET

MAN
81.44205.6010

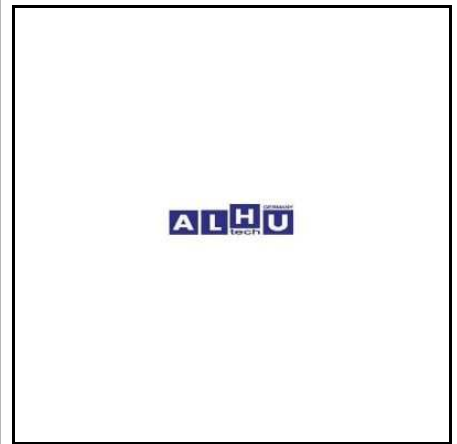

23 330 013 KING PIN SET

F 2000

MAN
81.44205.6013



23 330 016 KING PIN SET

G 90

MAN
81.44205.6016

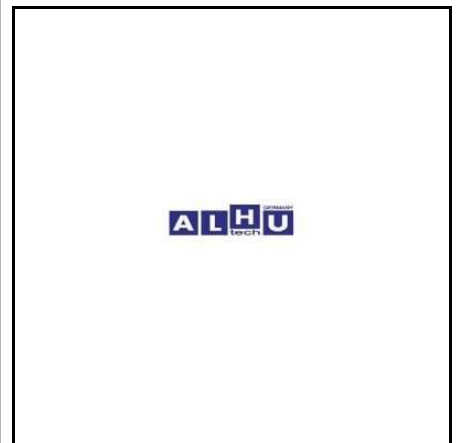

Achse / Axle

23 330 018 KING PIN SET

MAN
81.44205.6018



23 330 023 KING PIN SET

F 2000

MAN
81.44205.6023



23 330 024 KING PIN SET

L 2000

MAN
81.44205.6024

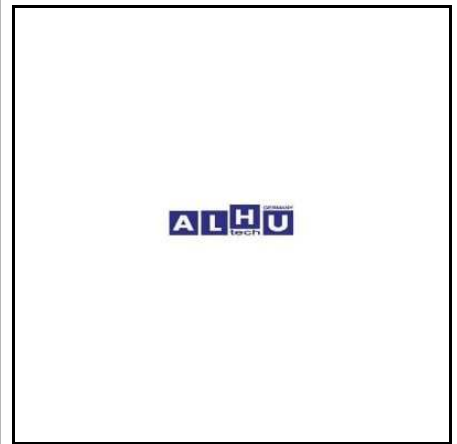

23 330 025 KING PIN SET

L 2000 M 2000

MAN
81.44205.6025

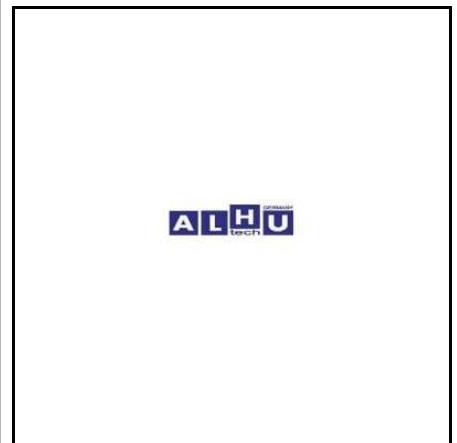

Achse / Axle

23 330 027 KING PIN SET

L 2000 M 2000

MAN
81.44205.6027



23 330 030 KING PIN SET

F 2000 TGA TGS

MAN
81.44205.6030
81.44205.6037



23 330 031 KING PIN SET

TGA TGS TGX

MAN
81.44205.6031
81.44205.6038



23 323 010 LOCATING ARM

F 2000

MAN
81.41715.6010



Achse / Axle

21 994 109 LOCK PLATE

MAN
81.90801.0225

Mercedes Benz
346 994 01 09



21 620 048 LOCK RING

MAN
81.90620.0048

Mercedes Benz
355 356 01 26



23 356 002 LOCK RING

MAN
81.41355.0001



63 450 192 LOCK RING M100X1,5

TGA TGS TGX

MAN
81.90620.0092



Achse / Axle

63 450 150 NEEDLE SLEEVE

MAN
06.33719.0057

ZF
7230110000

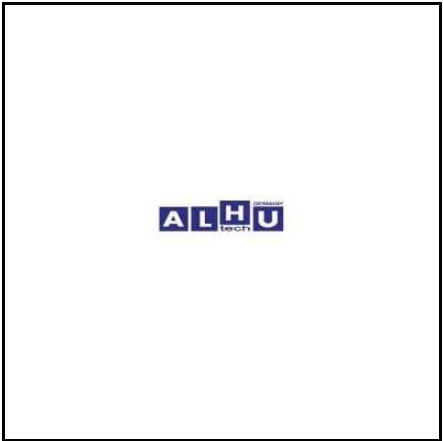

21 353 126 NUT

MAN
81.90620.0047

Mercedes Benz
346 353 01 26

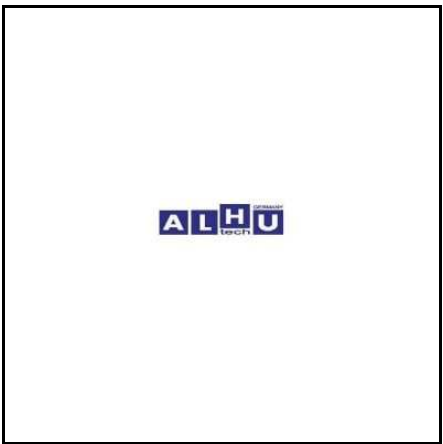

21 503 333 OIL SEAL

MAN
81.96503.0333

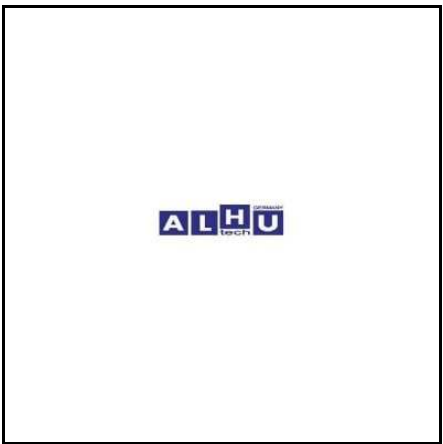

63 450 102 OUTPUT SHAFT

MAN
81.35604.0017

Mercedes Benz
385 353 08 35

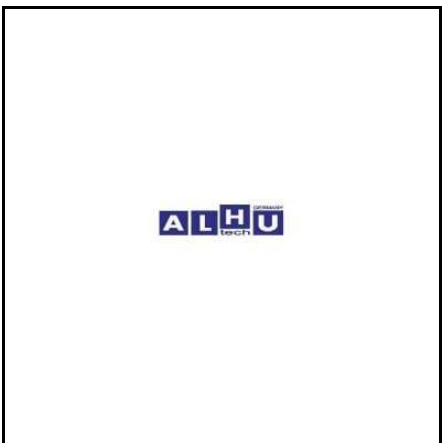

Achse / Axle

63 450 094 PARABOLIC SPRING

TGA TGS TGX

MAN
81.43402.6225



63 450 283 PARABOLIC SPRING

MAN
81.43402.6058



63 453 054 PARABOLIC SPRING



MAN
81.43402.6217
81.43402.6224



63 453 055 PARABOLIC SPRING



MAN
81.43402.6300
81.43402.6320



Achse / Axle

63 451 115 PIN

MAN
81.50211.0030

Mercedes Benz
307 421 00 74



23 356 215 PRESSURE RING

MAN
81.35710.0045

Mercedes Benz
355 356 12 15



23 356 415 PRESSURE RING

MAN
81.35710.0044

Mercedes Benz
346 356 14 15



63 450 079 PROPELLER SHAFT

MAN
81.39335.6110



Achse / Axle

63 450 158 PROPELLER SHAFT

MAN
81.39324.6068

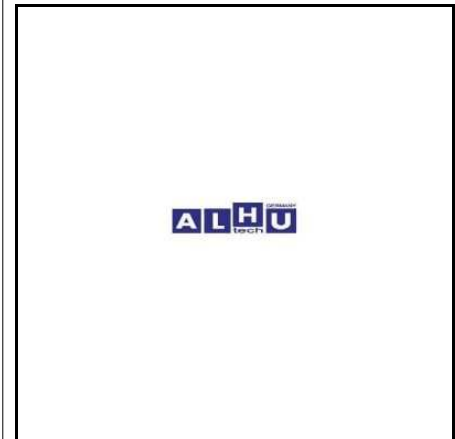

63 450 159 PROPELLER SHAFT

MAN
81.39324.6070

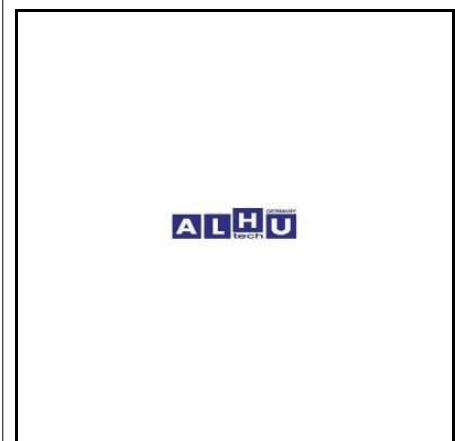

24 410 017 PROPELLER SHAFT BEARING

F 2000 TGA TGS TGX

MAN
81.39410.6017
81.39410.6019

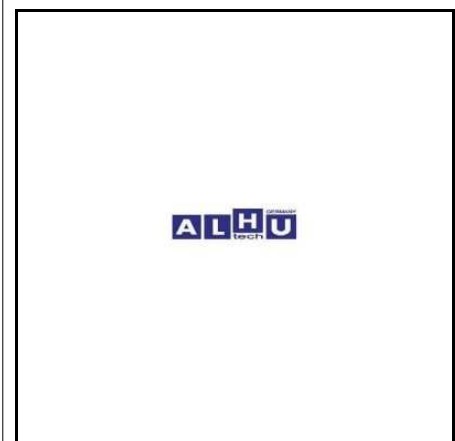

24 410 018 PROPELLER SHAFT BEARING

L 2000 M 2000

MAN
81.39410.6018

Iveco
93192009

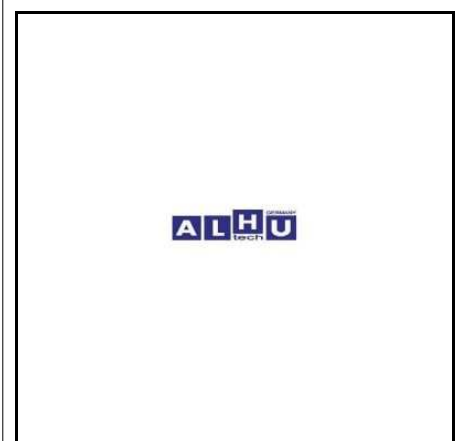

Achse / Axle

24 410 021 PROPELLER SHAFT BEARING

TGA

MAN

81.39410.6021

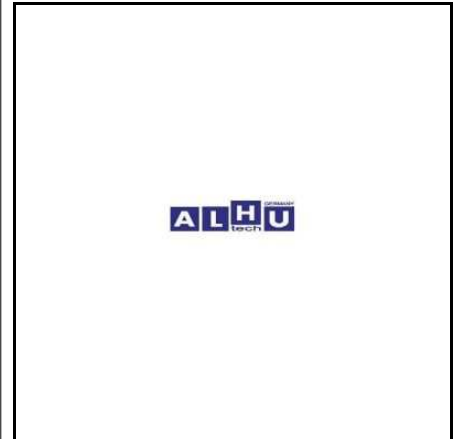

24 410 023 PROPELLER SHAFT BEARING

TGA

MAN

81.39410.6023

81.39410.6031

81.39410.6034

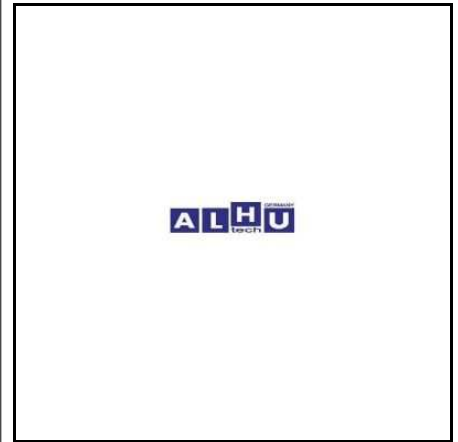

63 450 018 PROPELLER SHAFT BEARING

TGA

MAN

81.39410.6032



63 450 107 PROPELLER SHAFT BEARING

MAN

81.39410.6037

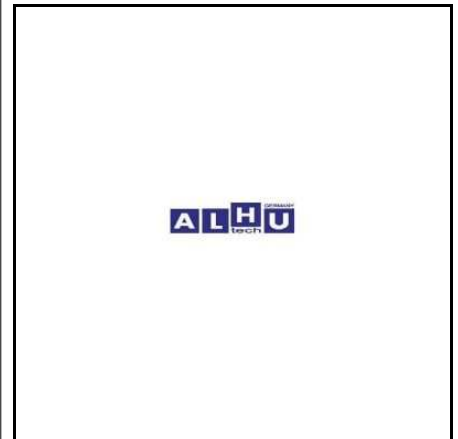

Achse / Axle

63 450 481 PROPELLER SHAFT MOUNTING

MAN
81.96210.0063



23 356 001 PROTECTIVE RING

MAN
81.41353.0001

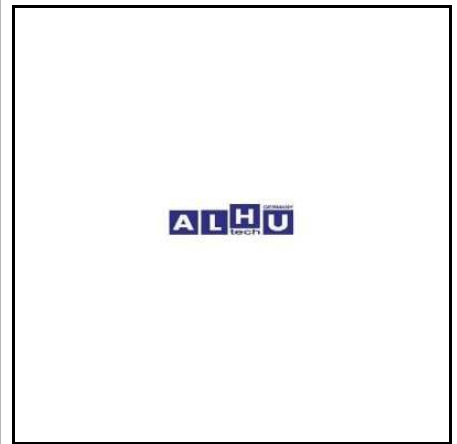

63 451 119 RADIATOR MOUNTING

MAN
81.96210.0243

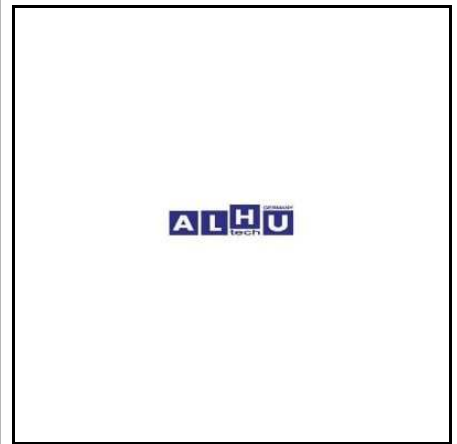

63 450 151 REPAIR KIT

F 2000

MAN
81.41700.6096

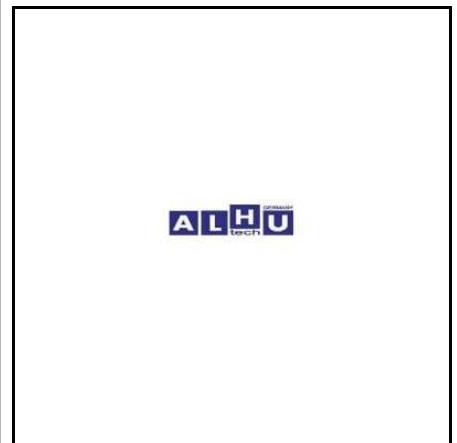

Achse / Axle

63 450 085 RUBBER BUFFER

MAN
81.96210.0479



63 450 458 RUBBER BUFFER

MAN
85.96210.0039



21 000 014 RUBBER BUSHING

MAN
85.41715.0006



63 451 114 RUBBER BUSHING

MAN
81.43706.0011



Achse / Axle

21 000 013 RUBBER MOUNTING

MAN
81.96210.0240



21 240 001 RUBBER MOUNTING

MAN
88.43704.0002



23 321 186 RUBBER MOUNTING

MAN
81.96020.0186

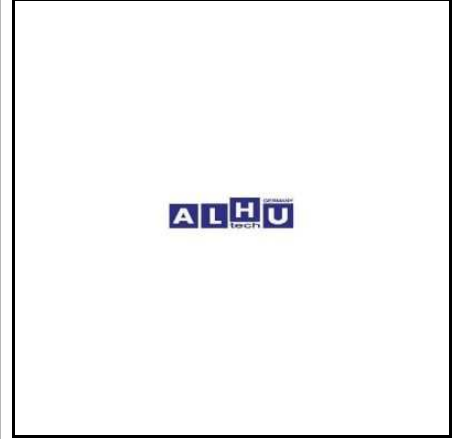

63 450 049 RUBBER MOUNTING

MAN
81.96210.0379



Achse / Axle

63 450 080 RUBBER MOUNTING

MAN
81.96210.0508



63 450 540 RUBBER MOUNTING

MAN
81.96210.0540



63 451 120 RUBBER MOUNTING

MAN
81.96210.0121



63 451 341 RUBBER MOUNTING

MAN
81.41401.0055



Achse / Axle

63 451 342 RUBBER MOUNTING

MAN
81.41506.6195

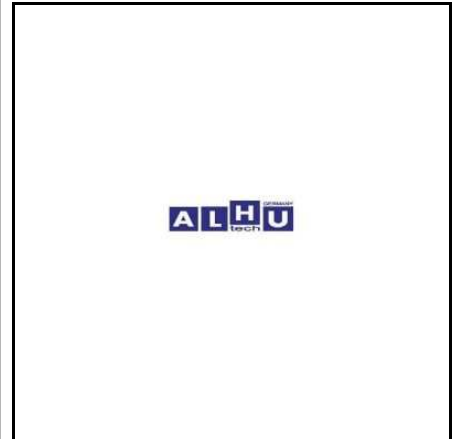

63 451 345 RUBBER MOUNTING

MAN
81.43271.0029



63 451 346 RUBBER MOUNTING

MAN
81.43271.0087



63 451 347 RUBBER MOUNTING

MAN
81.43407.0112

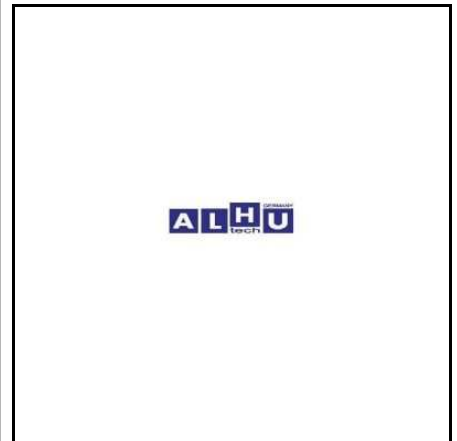

Achse / Axle

63 451 348 RUBBER MOUNTING

MAN
81.43704.0025



63 451 349 RUBBER MOUNTING

MAN
81.43704.0038



63 451 350 RUBBER MOUNTING

MAN
81.43704.0053



63 451 351 RUBBER MOUNTING

MAN
81.44204.0012

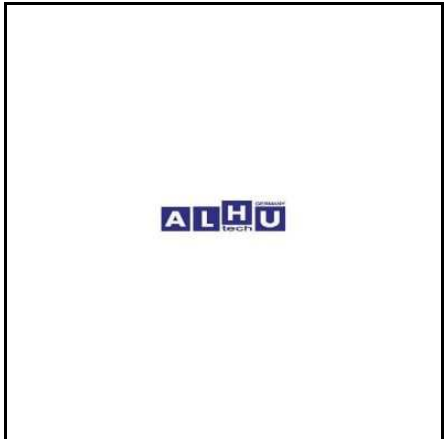

Achse / Axle

63 451 368 RUBBER MOUNTING

MAN
81.96210.0100



63 451 369 RUBBER MOUNTING

MAN
81.96210.0130



63 451 370 RUBBER MOUNTING

MAN
81.96210.0132



63 451 371 RUBBER MOUNTING

MAN
81.96210.0278



Achse / Axle

63 451 372 RUBBER MOUNTING

MAN
81.96210.0289



63 451 373 RUBBER MOUNTING

MAN
81.96210.0294



63 451 374 RUBBER MOUNTING

MAN
81.96210.0348



63 451 375 RUBBER MOUNTING

MAN
81.96210.0353



Achse / Axle

63 451 376 RUBBER MOUNTING

MAN
81.96210.0402



63 451 377 RUBBER MOUNTING

MAN
81.96210.5011



63 451 387 RUBBER MOUNTING

MAN
85.43704.0002



63 451 388 RUBBER MOUNTING

MAN
85.43722.0007

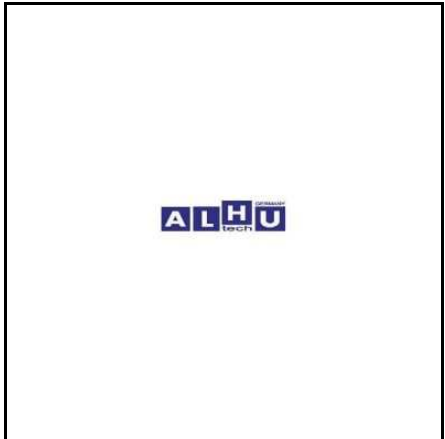

Achse / Axle

63 451 389 RUBBER MOUNTING

MAN
85.43722.0010



63 451 390 RUBBER MOUNTING

MAN
85.43722.0011



63 451 391 RUBBER MOUNTING

MAN
85.96210.0008



63 451 392 RUBBER MOUNTING

MAN
85.96210.0020

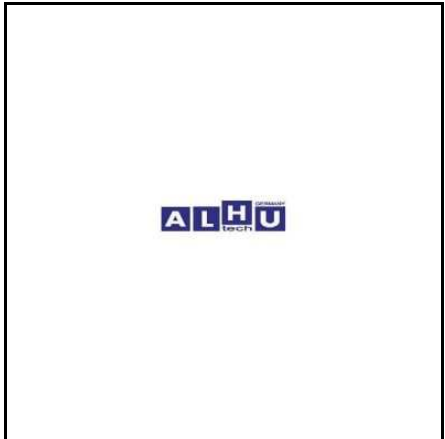

Achse / Axle

63 453 047 RUBBER MOUNTING



MAN
81.96210.0184



63 451 363 SCREW

MAN
81.90490.0696



63 451 366 SEAL

MAN
81.95310.0015



23 332 011 SEAL HOLDER

TGA TGS TGX

MAN
81.50308.0011

Mercedes Benz
346 423 00 58



Achse / Axle

63 451 152 SEAL HOLDER

MAN
81.35412.0009

Mercedes Benz
355 353 01 58



63 450 104 SELECTOR FORK

MAN
81.35614.0001

Mercedes Benz
355 353 02 34



63 450 105 SHIFT CYLINDER

MAN
81.35631.0006

Mercedes Benz
346 353 06 55



63 450 030 SHOCK ABSORBER

Neoplan
1203 362 00



Achse / Axle

63 450 034 SHOCK ABSORBER

MAN
81.43701.6714



63 450 035 SHOCK ABSORBER

MAN
81.43701.6893



63 450 037 SHOCK ABSORBER

MAN
81.43701.6890



63 450 038 SHOCK ABSORBER

MAN
81.43701.6794



Achse / Axle

63 450 039 SHOCK ABSORBER

MAN
81.43701.6911



63 450 040 SHOCK ABSORBER

L 2000

MAN
81.43701.6927



63 450 050 SHOCK ABSORBER

MAN
81.43701.6793



63 450 065 SHOCK ABSORBER

MAN
81.43701.6713

Mercedes Benz
357 323 04 00



Achse / Axle

63 450 066 SHOCK ABSORBER

MAN
81.43701.6715



63 450 077 SHOCK ABSORBER

MAN
81.43701.6830



63 450 078 SHOCK ABSORBER
AIR SUSPENSION

MAN
81.43701.6924



63 450 081 SHOCK ABSORBER

MAN
81.43701.6900



Achse / Axle

63 450 082 SHOCK ABSORBER

MAN
85.41722.6010



63 450 116 SHOCK ABSORBER

MAN
81.43701.6964



63 450 117 SHOCK ABSORBER

MAN
81.43701.6948



63 450 138 SHOCK ABSORBER

MAN
81.43701.6842



Achse / Axle

63 450 196 SHOCK ABSORBER

MAN
85.41722.6011



63 450 813 SHOCK ABSORBER

MAN
81.43702.6077



63 451 395 SHOCK ABSORBER

 **MAN**
82.43701.6017



63 453 007 SHOCK ABSORBER

 **MAN**
81.43701.6584



Achse / Axle

63 453 009 SHOCK ABSORBER



MAN
81.43701.6904

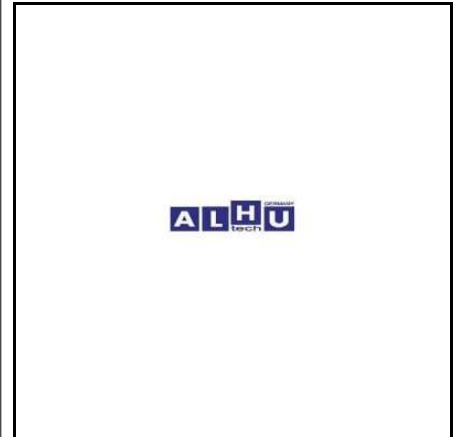

21 710 163 SPACER

MAN
81.91710.0163

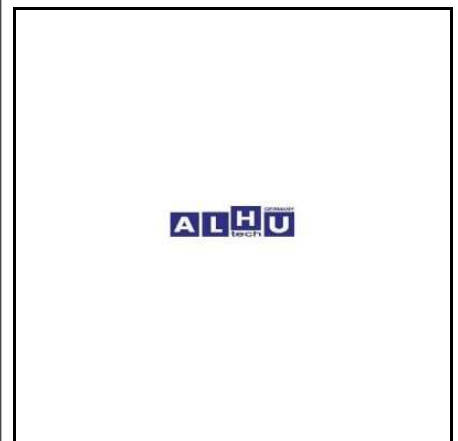

24 420 243 SPACER

MAN
81.90713.0243

Mercedes Benz
346 423 07 52



21 002 000 SPRING BOLT

MAN
06.09019.0032

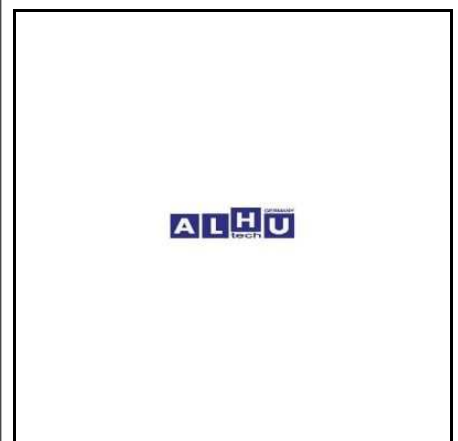

Achse / Axle

21 002 001 SPRING BOLT

MAN
06.09019.0049



21 002 002 SPRING BOLT

MAN
06.09019.0063



21 002 003 SPRING BOLT

MAN
06.09019.0095



23 322 110 SPRING BRACKET
front, right

F 2000

MAN
81.41301.6114



Achse / Axle

23 322 111 SPRING BRACKET
 front, keft
 F 2000

MAN
 81.41301.6115

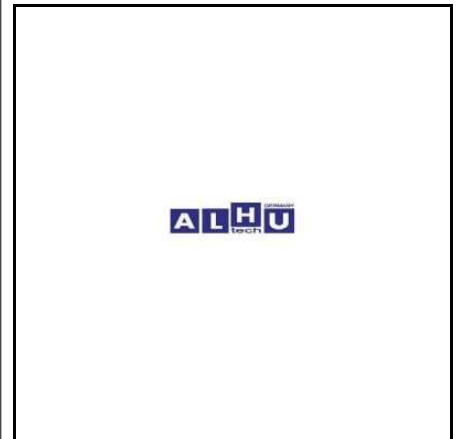

23 324 253 SPRING BRACKET
 front

MAN
 81.41301.0253

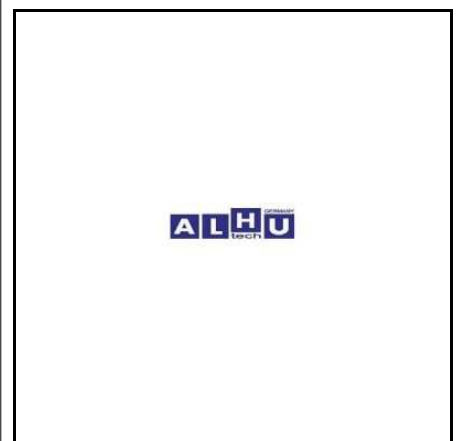

23 321 230 SPRING BUFFER

MAN
 81.96020.0230

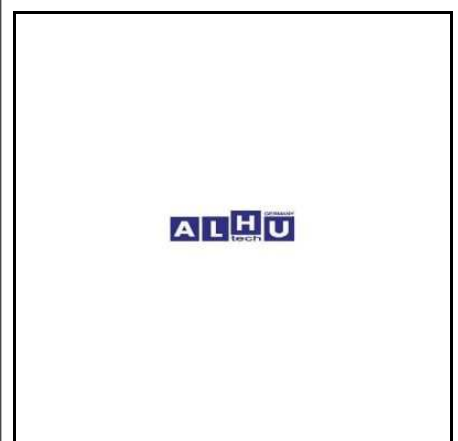

23 324 006 SPRING BUFFER

MAN
 81.96020.6006



Achse / Axle

23 324 739 SPRING BUFFER

MAN
81.96101.0739



23 326 431 SPRING BUFFER

MAN
81.96210.0431



23 324 040 SPRING BUSHING

MAN
81.41304.0040



23 324 061 SPRING BUSHING

MAN
81.43722.0061



Achse / Axle

23 324 062 SPRING BUSHING

MAN
81.43722.0062



23 324 070 SPRING BUSHING

MAN
81.43722.0070

TGA TGX TGS



63 451 337 SPRING BUSHING

MAN
81.41304.0041



63 451 338 SPRING BUSHING

MAN
81.41304.0042



Achse / Axle

63 451 339 SPRING BUSHING

MAN
81.41304.0043



63 451 340 SPRING BUSHING

MAN
81.41304.0050



23 325 022 SPRING CUSHION

F 2000

MAN
81.96210.5022



23 325 025 SPRING CUSHION

TGA

MAN
81.96210.5025



Achse / Axle

23 325 550 SPRING CUSHION

MAN
81.96210.0550



23 325 554 SPRING CUSHION
right
TGA

MAN
81.96210.0554



23 325 555 SPRING CUSHION
left
TGA

MAN
81.96210.0555



23 325 001 SPRING HANGER

MAN
81.41350.0009



Achse / Axle

23 325 018 SPRING HANGER

MAN
81.41350.0018



23 326 017 SPRING HANGER

MAN
81.41350.0017



63 451 661 SPRING MOUNTING

MAN
85.96210.0025



21 000 010 SPRING PAD

MAN
81.43407.0102

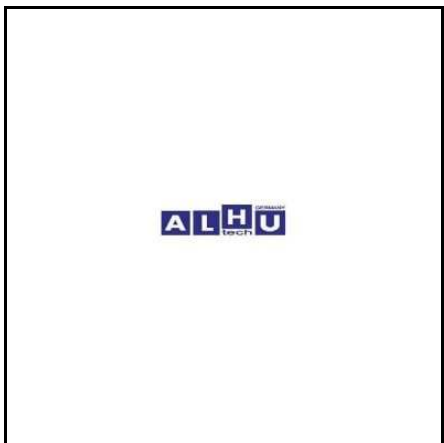

Achse / Axle

21 000 011 SPRING PAD

MAN
81.43407.5003



23 325 065 SPRING SADDLE

MAN
81.41320.0065



23 324 079 SPRING SHACKLE

MAN
81.41303.0079



21 000 012 STABILIZER MOUNTING

TGA TGX TGS

MAN
81.43722.0087



Achse / Axle

21 722 048 STABILIZER MOUNTING

MAN
81.43722.0048



23 323 021 STABILIZER MOUNTING

MAN
81.44204.0021



23 323 029 STABILIZER MOUNTING

MAN
81.43704.0029



23 323 047 STABILIZER MOUNTING

MAN
81.43722.0047



Achse / Axle

23 323 057 STABILIZER MOUNTING

MAN
81.43704.0057

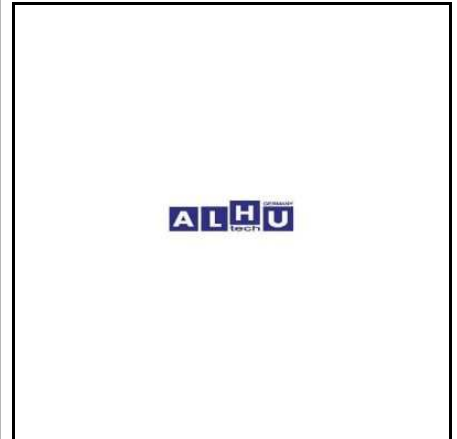

23 323 074 STABILIZER MOUNTING

MAN
81.43704.0074



23 323 077 STABILIZER MOUNTING

MAN
81.43704.0077



23 323 078 STABILIZER MOUNTING

MAN
81.43704.0078



Achse / Axle

23 323 081 STABILIZER MOUNTING

MAN
81.43271.0081

Mercedes Benz
396 323 00 50



23 323 150 STABILIZER MOUNTING

MAN
81.96210.0150



23 323 159 STABILIZER MOUNTING

MAN
81.43722.0059



23 324 086 STABILIZER MOUNTING

MAN
81.43722.0085



Achse / Axle

23 325 074 STABILIZER MOUNTING

MAN
81.43271.0074



23 326 025 STABILIZER MOUNTING

MAN
81.43316.0021



23 326 032 STABILIZER MOUNTING

MAN
81.43704.0032



23 326 040 STABILIZER MOUNTING

MAN
81.43722.0040



Achse / Axle

23 326 052 STABILIZER MOUNTING

MAN
81.43722.0052



23 326 053 STABILIZER MOUNTING

MAN
81.43722.0053



23 326 060 STABILIZER MOUNTING

MAN
81.43704.0060

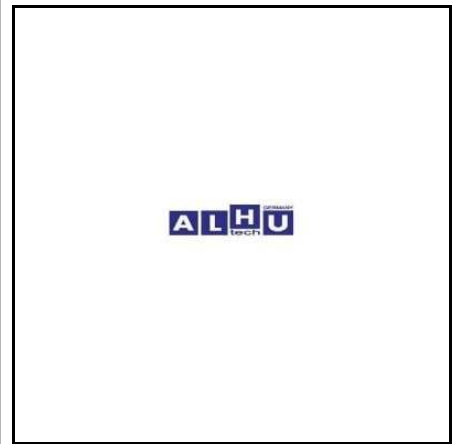

23 326 061 STABILIZER MOUNTING

MAN
81.43704.0061

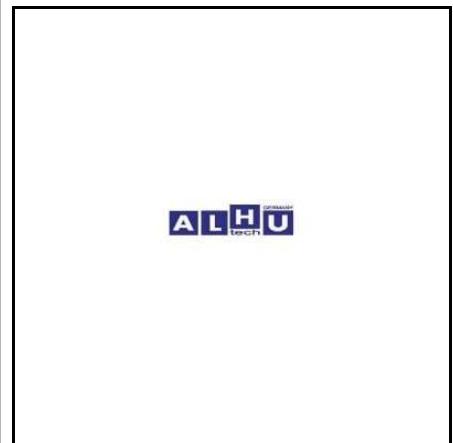

Achse / Axle

23 326 062 STABILIZER MOUNTING

MAN
81.43722.0051
81.43722.0060

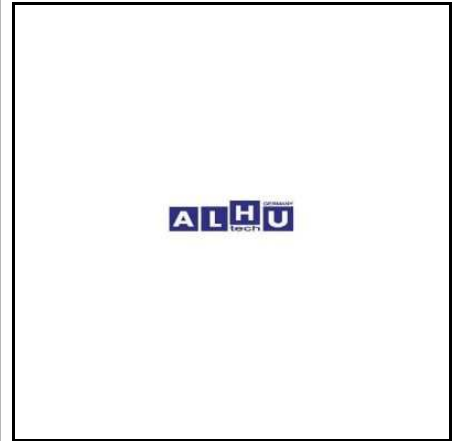

23 326 063 STABILIZER MOUNTING

F 2000

MAN
81.43722.0063



23 326 068 STABILIZER MOUNTING

MAN
81.43722.0068

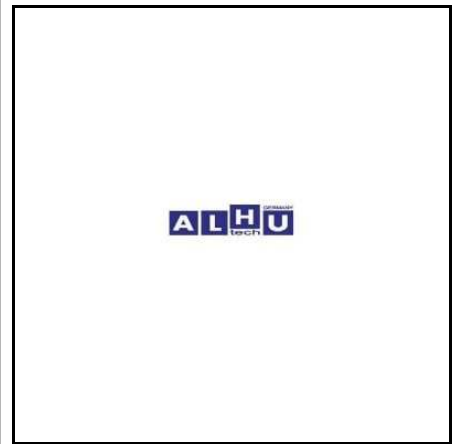

23 326 072 STABILIZER MOUNTING

MAN
81.43722.0072

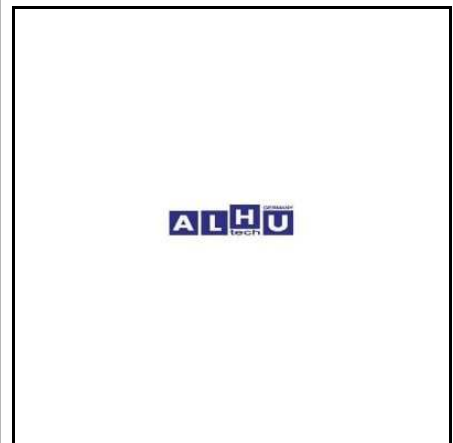

Achse / Axle

23 326 078 STABILIZER MOUNTING

MAN
81.43271.0078



23 326 080 STABILIZER MOUNTING

MAN
81.43271.0080

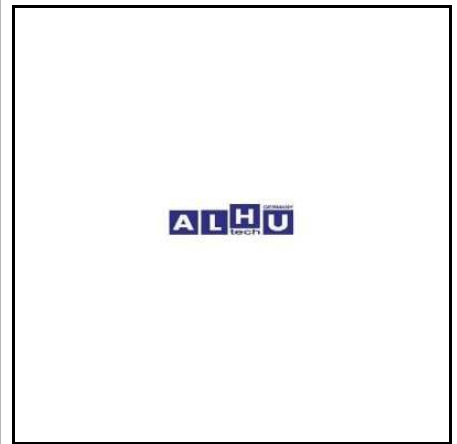

23 326 082 STABILIZER MOUNTING

MAN
81.43271.0082

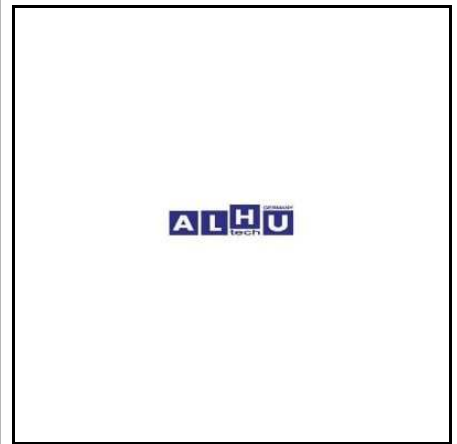

23 326 083 STABILIZER MOUNTING

MAN
81.43271.0083



Achse / Axle

23 326 450 STABILIZER MOUNTING

MAN
81.96210.0450

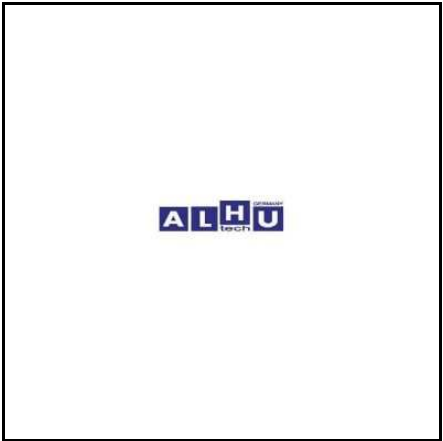

23 326 511 STABILIZER MOUNTING

MAN
81.96210.0452
81.96210.0511
81.99164.8844

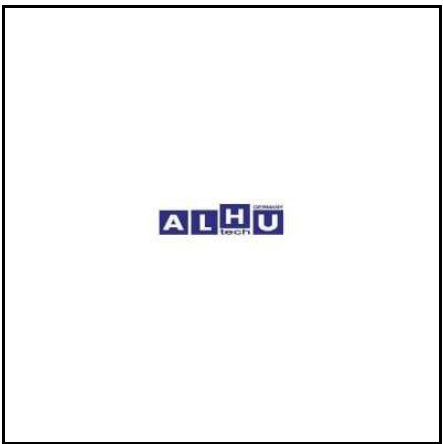

23 327 083 STABILIZER MOUNTING

MAN
81.43722.0083

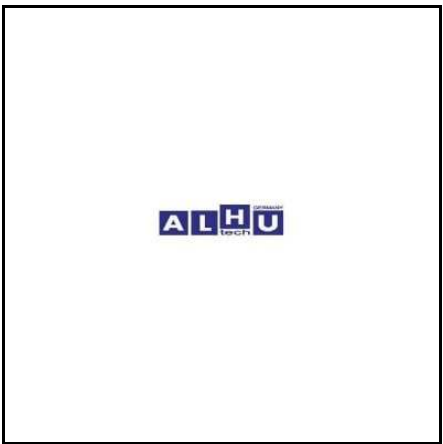

63 450 139 STABILIZER MOUNTING

MAN
81.43722.0019

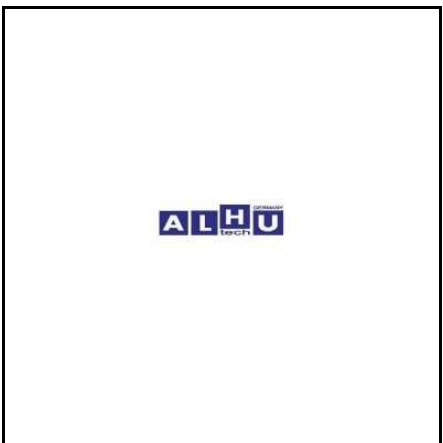

Achse / Axle

63 450 239 STABILIZER MOUNTING

MAN
81.43704.0076



63 450 571 STABILIZER MOUNTING

MAN
85.43704.0005



63 450 572 STABILIZER MOUNTING

MAN
81.43722.0091



63 450 579 STABILIZER MOUNTING

MAN
81.43722.0092



Achse / Axle

63 450 835 STABILIZER MOUNTING

MAN
81.43704.0079



63 451 113 STABILIZER MOUNTING

MAN
81.43704.0045



63 451 367 STABILIZER MOUNTING

MAN
81.96020.0286



63 450 113 STOP WASHER

MAN
85.90710.0014



Achse / Axle

21 353 925 THREADED RING

MAN
81.90685.0053

Mercedes Benz
346 353 09 25



21 410 003 THREADED ROD

MAN
81.39460.0003



616701 THRUST WASHER

MAN
81.35204.0018

Mercedes Benz
355 353 18 62



616705 THRUST WASHER

MAN
81.90701.0722

Mercedes Benz
355 353 01 76



Achse / Axle

21 215 001 THRUST WASHER

F 2000

MAN
81.44215.0016

Mercedes Benz
386 332 00 62



21 336 062 THRUST WASHER

MAN
81.90711.0890

Mercedes Benz
346 336 00 62



63 450 687 THRUST WASHER

MAN
81.44215.0017



23 323 059 TRUNNION

MAN
81.35401.0059



Achse / Axle

23 323 089 TRUNNION

F 2000 TGA

MAN
81.35401.0089



63 450 685 TRUNNION

MAN
81.35401.0135



21 710 001 TRUST RING REPAIR KIT

F 2000 TGA

MAN
81.35710.6016



21 710 002 TRUST RING REPAIR KIT

MAN
81.35710.6008



Achse / Axle

21 410 004 UNIVERSAL JOINT

MAN
81.39126.6020

Iveco
42536996



63 450 001 UNIVERSAL JOINT

MAN
81.39126.6009



63 450 002 UNIVERSAL JOINT
MAINTENANCE FREE

MAN
81.39126.6030



63 450 004 UNIVERSAL JOINT

f 2000

MAN
81.39126.6033
81.39374.6004

Iveco
42534500



Achse / Axle

63 450 015 UNIVERSAL JOINT

MAN
81.39374.6001

Iveco
42533783



63 450 016 UNIVERSAL JOINT

MAN
81.39100.6007



63 450 017 UNIVERSAL JOINT

MAN
81.39108.6052

Mercedes Benz
000 330 07 28



63 450 021 UNIVERSAL JOINT

MAN
81.39108.6050
81.39108.6055
81.99917.8469

Iveco
93160516



Achse / Axle

63 450 028 UNIVERSAL JOINT

MAN
81.39126.6029



63 450 067 UNIVERSAL JOINT

MAN
81.36415.6035

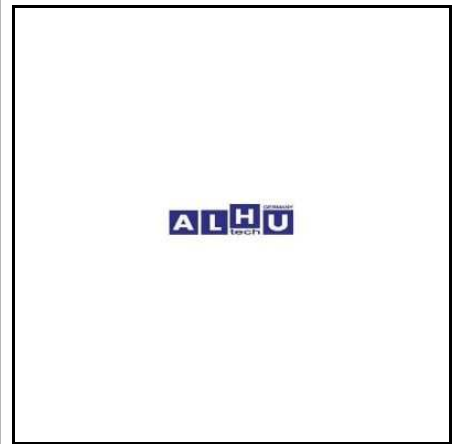

63 450 068 UNIVERSAL JOINT

MAN
81.39108.6053

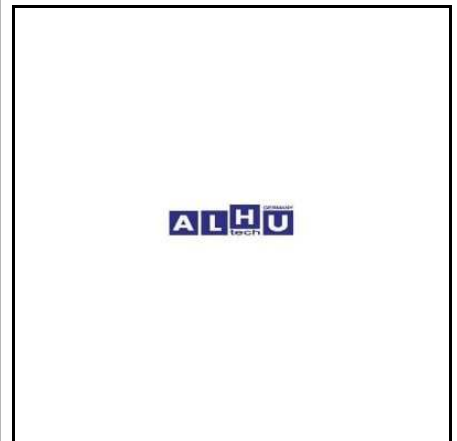

63 450 555 UNIVERSAL JOINT

MAN
81.39108.6229

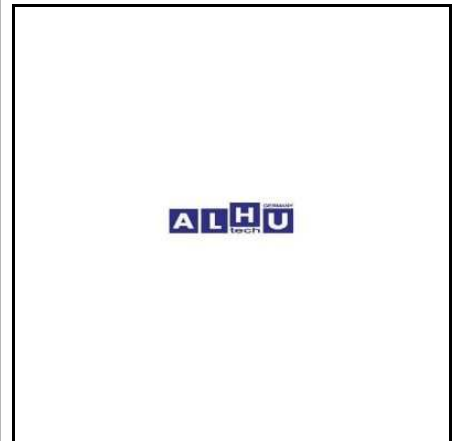

Achse / Axle

21 001 002 U-BOLT

MAN
06.46113.0370



21 001 003 U-BOLT

MAN
06.46113.2510



21 001 005 U-BOLT

MAN
06.46119.0003



73 240 001 U-BOLT

MAN
06.46110.2135



Achse / Axle

73 240 002 U-BOLT

MAN
06.46112.0205



73 240 003 U-BOLT

MAN
06.46115.0460



73 240 004 U-BOLT

MAN
06.46119.0021



73 240 005 U-BOLT

MAN
06.46113.3360



Achse / Axle

21 302 021 WASHER

MAN
81.41302.0021



21 710 057 WASHER

MAN
81.90710.0057



23 303 022 WASHER

F 2000

MAN
81.44303.0022



23 303 034 WASHER

F 2000

MAN
81.44303.0034



Achse / Axle

23 326 030	WASHER
<p>MAN 81.41302.0030</p>	

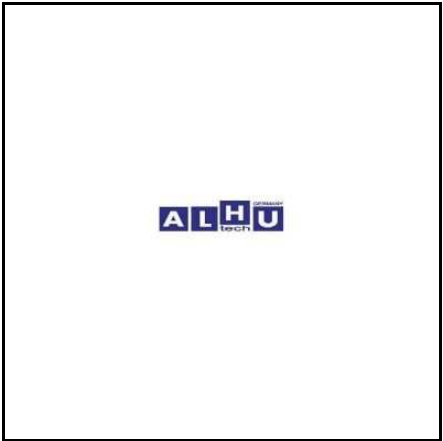

21 356 008	WHEEL HUB
<p>MAN 81.44301.0169</p>	



21 356 009	WHEEL HUB
<p>MAN 81.35701.0155</p>	

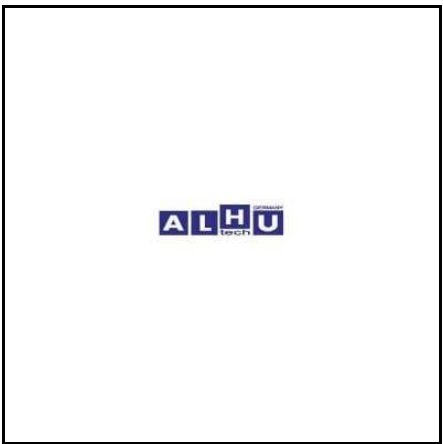

21 356 010	WHEEL HUB
<p>MAN 81.35701.0159</p>	

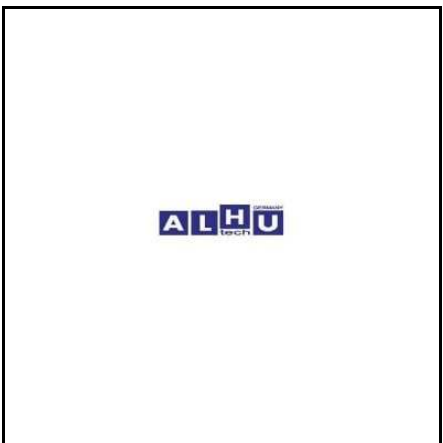

Achse / Axle

21 356 011 WHEEL HUB

MAN
81.44301.0107

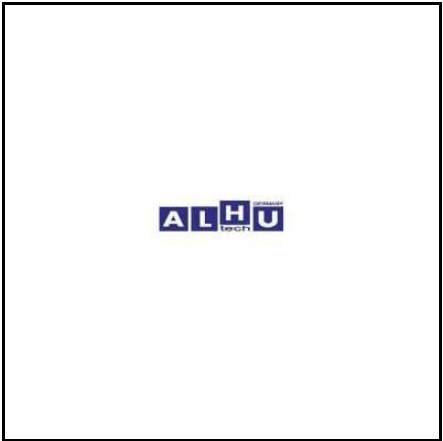

21 356 012 WHEEL HUB
front F 2000

MAN
81.44301.0146

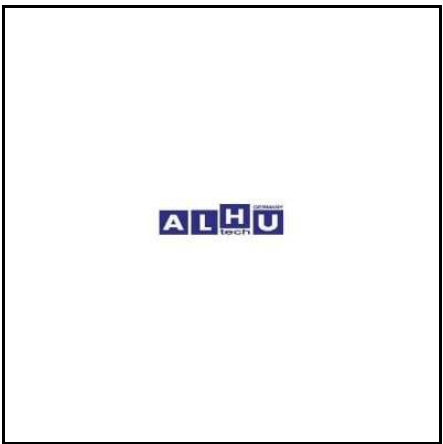

21 356 013 WHEEL HUB

MAN
81.36501.0091

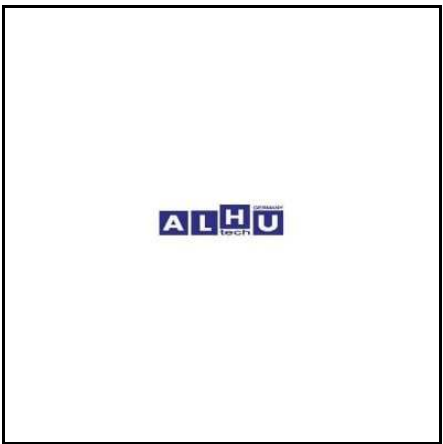

21 356 014 WHEEL HUB

MAN
81.44301.0179

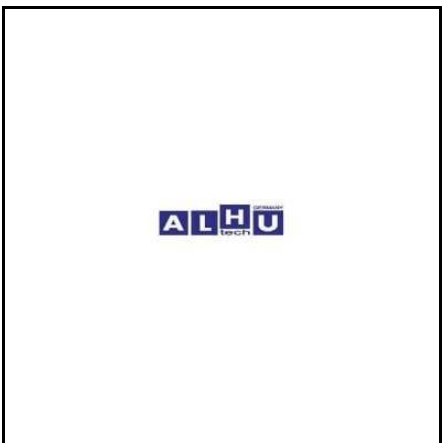

Achse / Axle

21 356 019 WHEEL HUB

MAN
81.44301.0174



21 356 020 WHEEL HUB

MAN
81.44301.0182



21 356 035 WHEEL HUB
front TGA

MAN
81.44301.0177



21 356 037 WHEEL HUB

MAN
81.36501.0107



Achse / Axle

21 356 038 WHEEL HUB

MAN
81.35701.0146



21 356 039 WHEEL HUB

MAN
81.35701.0147

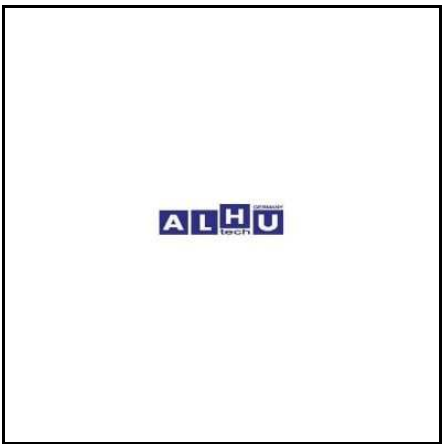

23 356 141 WHEEL HUB

MAN
81.35701.0141

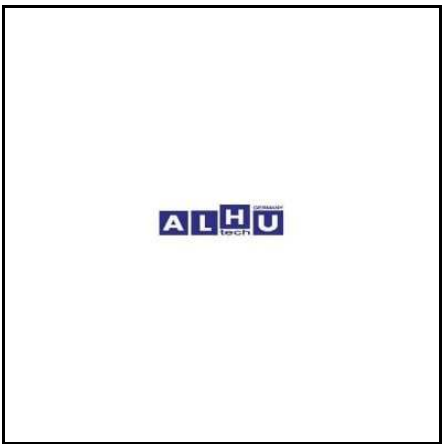

63 450 842 WHEEL NUT

MAN
81.45503.0055
81.45503.0058

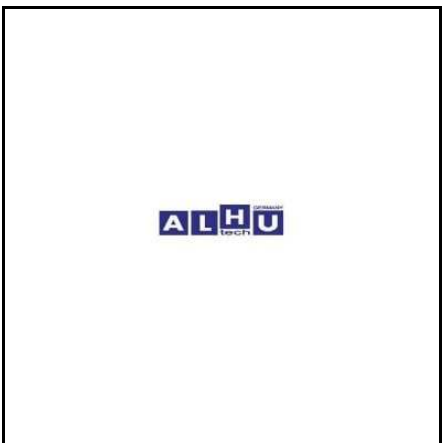

Bremse / Brake

22 120 156 ABS SENSOR

MAN
81.27120.6156

Bosch
0486000241N00



22 120 149 ABS SENSOR

MAN
81.27120.6149

Bosch
0 486 000 238



22 120 151 ABS SENSOR

MAN
81.27120.6151

Bosch
0486000240N00



63 450 748 ABS SENSOR

MAN
51.27120.7037

Bosch
0 281 002 315



Bremse / Brake

63 450 756 ABS SENSOR

MAN
81.27120.6064

KNORR
0486000103N00



63 450 757 ABS SENSOR

MAN
81.27120.6065

KNORR
0486000104N00



63 450 758 ABS SENSOR

MAN
81.27120.6165

KNORR
0486000256N00



63 450 759 ABS SENSOR

MAN
81.27120.6164

KNORR
0486000257N00



Bremse / Brake

63 450 760 ABS SENSOR

MAN
81.27120.6169

KNORR
0486000260N00



63 450 761 ABS SENSOR

MAN
81.27120.6168

KNORR
0486000261N00



63 450 762 ABS SENSOR

MAN
81.27120.6146

KNORR
0486001041N00



63 450 763 ABS SENSOR

MAN
81.27120.6147

KNORR
0486001042N00



Bremse / Brake

63 450 765 ABS SENSOR

MAN
81.27120.6150

Bosch
0486000239N00



63 450 766 ABS SENSOR

MAN
81.27120.6151

Bosch
0486000240N00



63 450 768 ABS SENSOR

MAN
81.27120.6157

Bosch
0 486 000 242



63 450 776 ABS SENSOR



MAN
81.27120.6209

Wabco
441.032.165.0



Bremse / Brake

63 450 777 ABS SENSOR



MAN
81.27120.6210

Wabco
441.032.166.0



63 450 778 ABS SENSOR



MAN
81.27120.6186

Wabco
441.032.288.0



63 450 779 ABS SENSOR



MAN
81.27120.6187

Wabco
441.032.289.0



63 450 780 ABS SENSOR



MAN
81.27120.6189

Wabco
441.032.291.0



Bremse / Brake

63 450 781 ABS SENSOR



MAN
81.27120.6182

Wabco
441.032.296.0



63 450 782 ABS SENSOR



MAN
81.27120.6183

Wabco
441.032.297.0



63 450 783 ABS SENSOR



MAN
81.27120.6184

Wabco
441.032.298.0



63 450 784 ABS SENSOR



MAN
81.27120.6185

Wabco
441.032.299.0



Bremse / Brake

24 000 002 ABS SOLENOID VALVE

MAN
81.52452.6014
81.52452.6015

KNORR
II15492



21 130 003 AIR COMPRESSOR

MAN
51.54100.7003



21 130 007 AIR COMPRESSOR

TGA

MAN
51.54100.6007
51.54100.9007



21 130 009 AIR COMPRESSOR

MAN
51.54100.6001



Bremse / Brake

21 130 015 AIR COMPRESSOR

MAN
51.54100.6015



21 130 016 AIR COMPRESSOR

MAN
51.54101.7247

KNORR
I136925



21 130 047 AIR COMPRESSOR

MAN
51.54000.7112



21 130 058 AIR COMPRESSOR

MAN
51.54000.7058



Bremse / Brake

21 130 063 AIR COMPRESSOR

MAN
51.54000.7063



21 130 065 AIR COMPRESSOR

MAN
51.54000.7128



21 130 079 AIR COMPRESSOR

MAN
51.54000.7079



21 130 121 AIR COMPRESSOR

MAN
51.54100.7121



Bremse / Brake

21 130 129 AIR COMPRESSOR

MAN
51.54000.7129

**21 131 021 AIR COMPRESSOR BEARING FLANGE**

MAN
51.54130.6021

**28 130 335 AIR COMPRESSOR BUSH**

MAN
51.93020.0335

**21 131 011 AIR COMPRESSOR BUSHING**

MAN
81.54130.0011

Mercedes Benz
000 131 30 50



Bremse / Brake

21 130 025 AIR COMPRESSOR CONROD

MAN
81.54106.0006

Mercedes Benz
000 131 18 17



21 130 039 AIR COMPRESSOR CONROD

MAN
81.54106.0013



21 130 816 AIR COMPRESSOR CONROD

MAN
51.54106.6013

Mercedes Benz
403 130 28 16



24 130 916 AIR COMPRESSOR CONROD

MAN
51.54106.6021

Mercedes Benz
442 131 00 17
442 131 02 17
541 131 00 17



Bremse / Brake

21 130 033 AIR COMPRESSOR CRANKSHAFT

MAN
81.54113.0038



21 130 040 AIR COMPRESSOR CRANKSHAFT

MAN
81.54113.0036



21 130 044 AIR COMPRESSOR CRANKSHAFT

MAN
51.54113.5044



21 131 016 AIR COMPRESSOR CRANKSHAFT

MAN
51.54113.0017

Mercedes Benz
403 131 07 16



Bremse / Brake

21 131 116 AIR COMPRESSOR CRANKSHAFT

MAN
51.54113.5027

Mercedes Benz
403 131 10 16



21 130 051 AIR COMPRESSOR CRANKSHAFT SCRE

MAN
51.90020.0131

Mercedes Benz
403 990 00 10

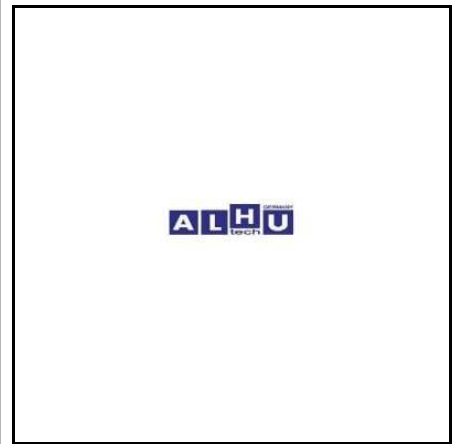

21 130 038 AIR COMPRESSOR CYLINDER

MAN
81.54105.0024

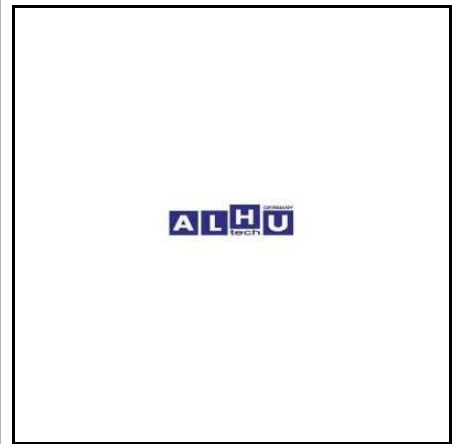

21 130 043 AIR COMPRESSOR CYLINDER

MAN
81.54114.0022

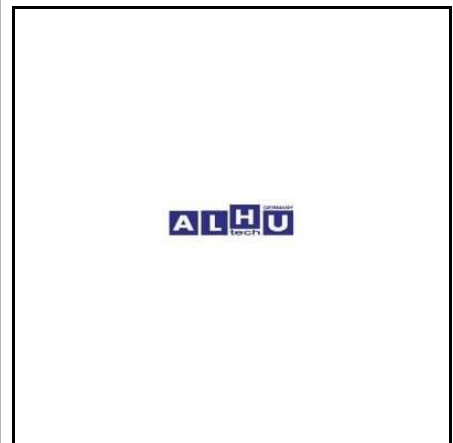

Bremse / Brake

21 130 019 AIR COMPRESSOR CYLINDER HEAD

MAN
51.54114.6054

KNORR
ZB4275

Mercedes Benz
000 130 26 19
407 130 05 19

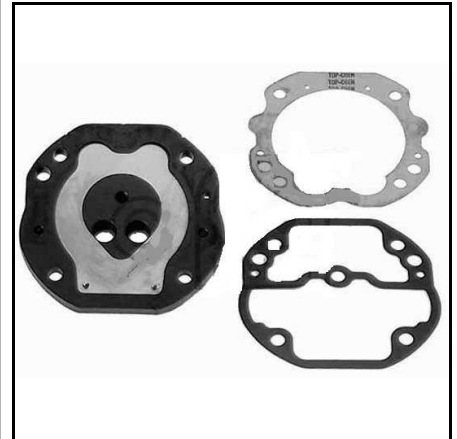

21 130 081 AIR COMPRESSOR CYLINDER HEAD

MAN
51.54114.6081

Wabco
412.090.803.2



21 130 021 AIR COMPRESSOR CYLINDER HEAD

MAN
51.54105.6021

Kolbenschmidt
89 535 110

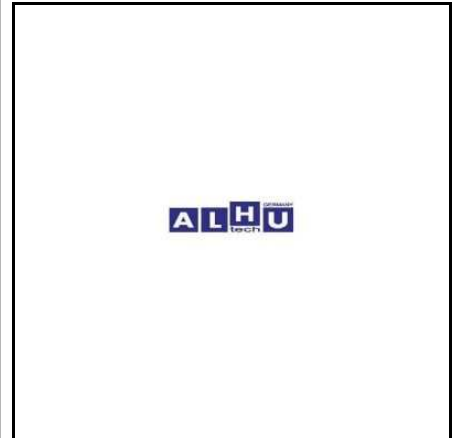

21 130 073 AIR COMPRESSOR CYLINDER HEAD

MAN
51.54114.6073

Wabco
412.100.806.2



Bremse / Brake

21 130 084 AIR COMPRESSOR CYLINDER HEAD

MAN
51.54114.6084

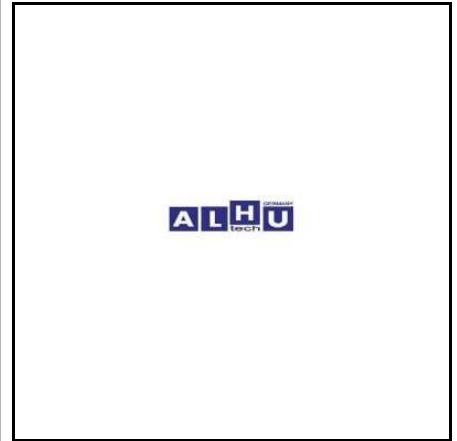

21 130 141 AIR COMPRESSOR DRIVE GEAR

MAN
51.54210.0141

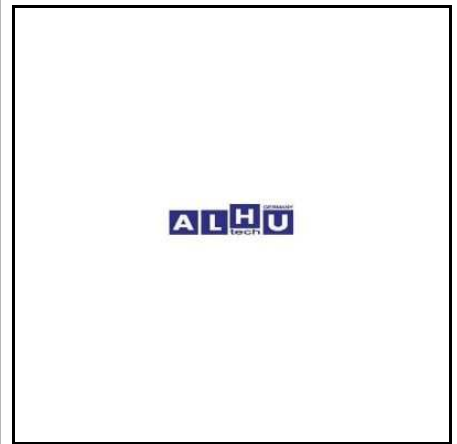

21 130 182 AIR COMPRESSOR DRIVE GEAR

MAN
51.54210.0182

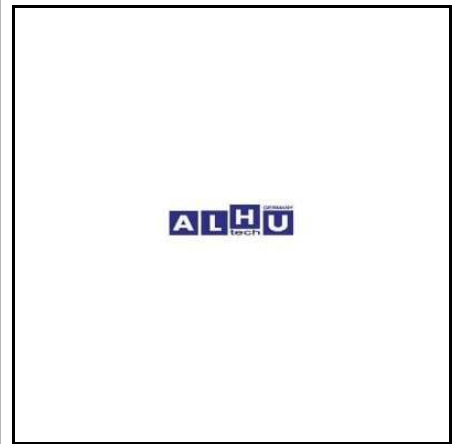

21 130 045 AIR COMPRESSOR FLANGE

MAN
51.54130.6011

Mercedes Benz
403 130 16 45

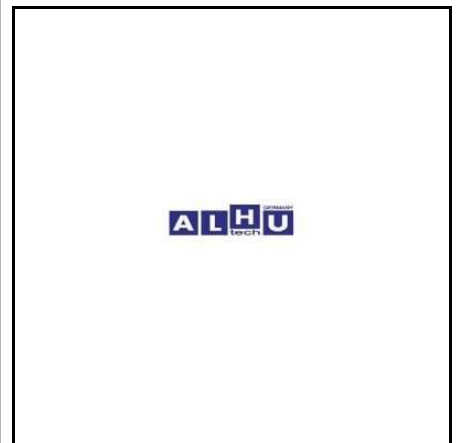

Bremse / Brake

21 130 048 AIR COMPRESSOR FLAP VALVE KIT

MAN
81.54124.6013

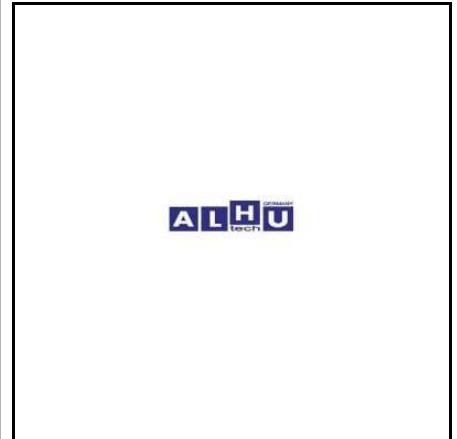

21 130 050 AIR COMPRESSOR FLAP VALVE KIT

MAN
81.54124.6019



21 130 034 AIR COMPRESSOR GASKET

MAN
51.54901.0034



21 130 035 AIR COMPRESSOR GASKET

MAN
51.54901.0035

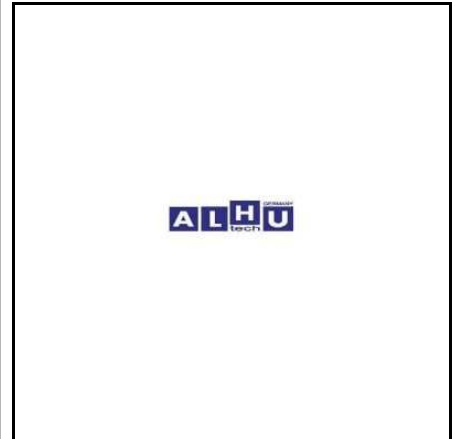

Bremse / Brake

21 130 042 AIR COMPRESSOR GASKET

MAN
51.54901.0042

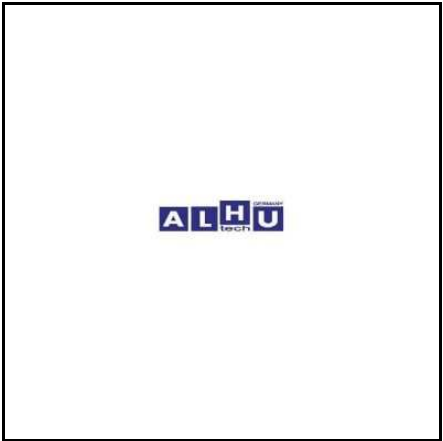

21 130 046 AIR COMPRESSOR GASKET

MAN
81.54901.0094

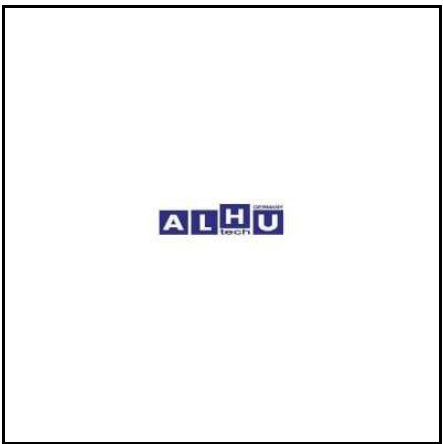

63 451 126 AIR COMPRESSOR GASKET

MAN
81.54901.0102

Wabco
897.317.013.4

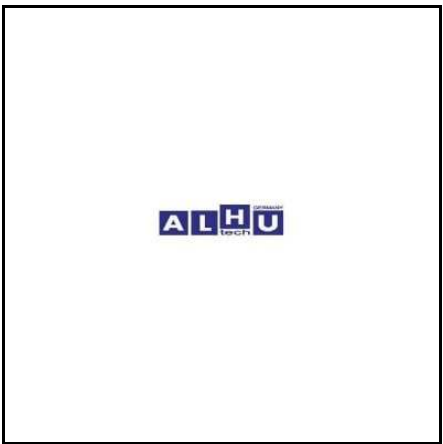

21 130 006 AIR COMPRESSOR GASKET SET

MAN
81.54901.6006

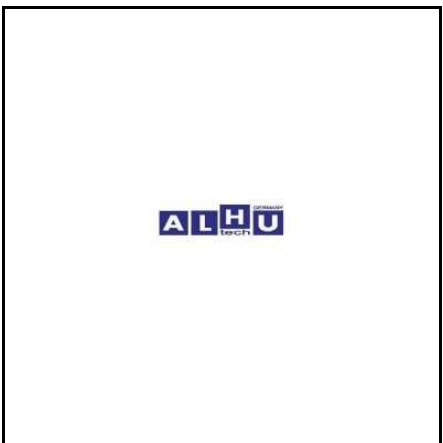

Bremse / Brake

21 130 010 AIR COMPRESSOR GASKET SET

MAN
81.54901.6007

**21 130 024 AIR COMPRESSOR GEAR**

MAN
51.54210.0038

**21 131 108 AIR COMPRESSOR GEAR**

MAN
51.54210.0108

**21 130 030 AIR COMPRESSOR HOUSING**

MAN
51.54112.6030



Bremse / Brake

21 130 110 AIR COMPRESSOR HOUSING

MAN
51.54112.6020



24 130 010 AIR COMPRESSOR HOUSING

MAN
51.54112.6008

Mercedes Benz
407 130 06 10



21 130 005 AIR COMPRESSOR LAMELLA

MAN
51.54124.6004



21 132 002 AIR COMPRESSOR PISTON

MAN
51.54119.6001

Kolbenschmidt
94919600



Bremse / Brake

21 130 008 AIR COMPRESSOR PISTON ASSEMBLY

MAN
51.54105.6006

Mercedes Benz
442 130 00 08



21 130 608 AIR COMPRESSOR PISTON ASSEMBLY

MAN
51.54105.6008

Mercedes Benz
402 130 06 08

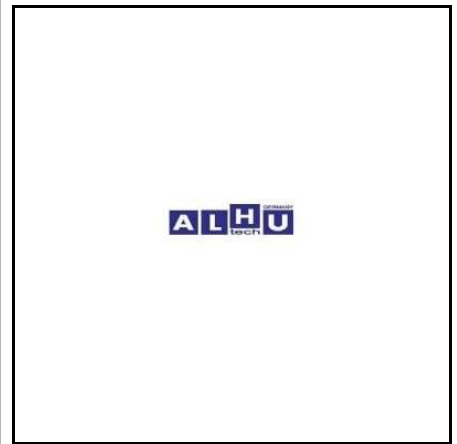

21 130 027 AIR COMPRESSOR PISTON RING

MAN
51.54103.0002

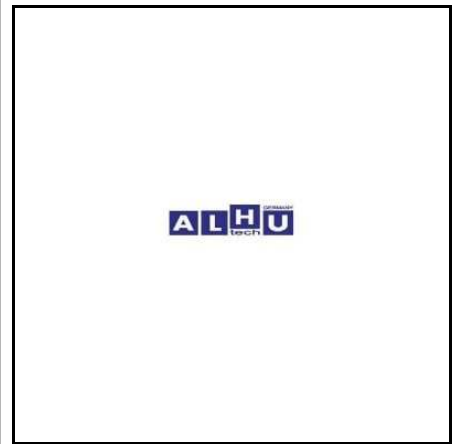

21 131 001 AIR COMPRESSOR PISTON RING

MAN
51.54103.0001

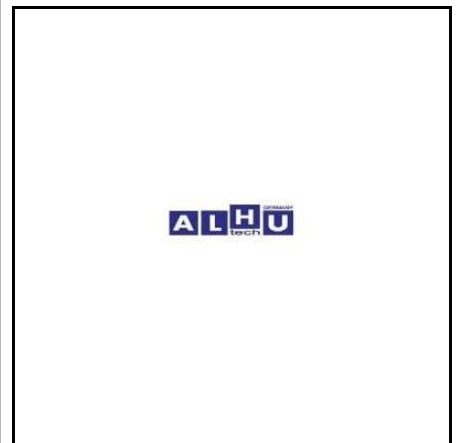

Bremse / Brake

21 132 009 AIR COMPRESSOR PISTON RING

MAN
51.54119.6009



21 130 004 AIR COMPRESSOR PRESSURE VALVE

MAN
81.54122.6004

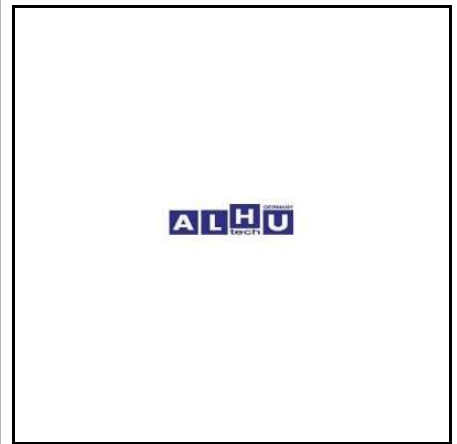

21 130 011 AIR COMPRESSOR REPAIR KIT

 **MAN**
51.54124.6003

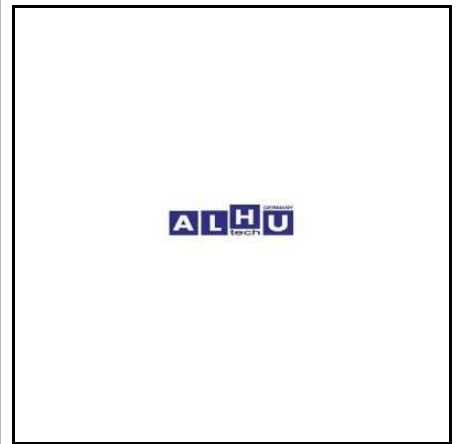

21 130 023 AIR COMPRESSOR REPAIR KIT

MAN
81.54124.6023

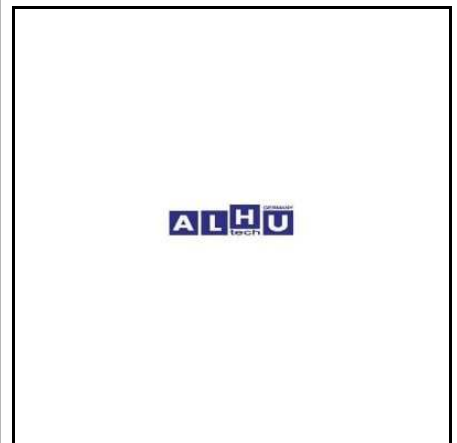

Bremse / Brake

21 130 049 AIR COMPRESSOR REPAIR KIT

MAN
51.54100.6049



21 130 064 AIR COMPRESSOR REPAIR KIT

MAN
81.54101.6055



21 130 132 AIR COMPRESSOR REPAIR KIT

MAN
81.54124.0005

Mercedes Benz
000 130 13 20



21 131 042 AIR COMPRESSOR REPAIR KIT

MAN
51.54100.6042



Bremse / Brake

21 130 002 AIR COMPRESSOR SUCTION DISC

MAN
51.54116.0002



21 130 320 AIR COMPRESSOR VALVE PLATE KIT

Mercedes Benz
402 130 03 20



24 000 009 AIR DRYER

F 2000

MAN
81.52102.6098
81.52102.6100

KNORR
II19206

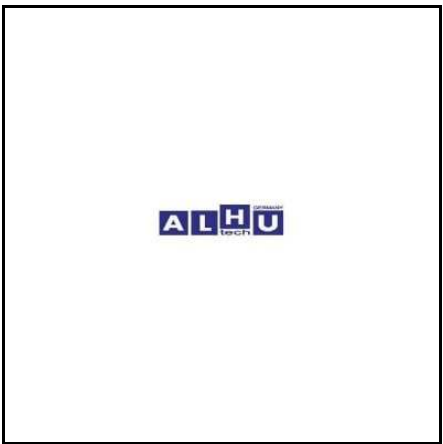

24 000 010 AIR DRYER

TGA TGS TGX

MAN
81.52102.6101

Wabco
432.410.113.0

KNORR
II19208

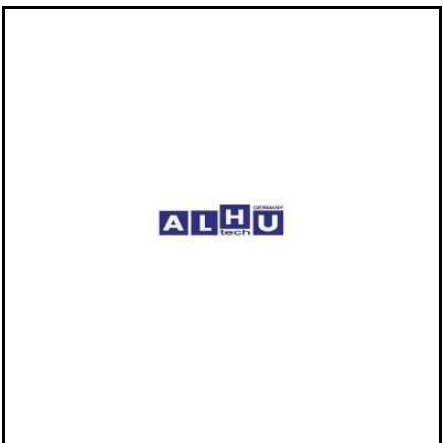

Bremse / Brake

24 410 010 AIR DRYER

MAN 81.52102.6072	Wabco 432.410.250.0
KNORR II31477	



63 453 018 AIR DRYER



MAN 81.52102.6103 81.52102.6104	Wabco 432.410.116.0
KNORR II19207	



21 350 001 AIR DRYER CARTRIDGE

MAN 82.52102.0013	KNORR II40100F
Mercedes Benz 000 429 37 95 000 430 09 69	Mann + Hummel TB 1374X

weitere/another



21 350 003 AIR DRYER CARTRIDGE

MAN 81.52108.6025	Mann + Hummel TB 1394/1 X
Mercedes Benz 000 429 56 95	Volvo 20557234 20972915 21508133

weitere/another



Bremse / Brake

21 350 008 AIR DRYER CARTRIDGE	
MAN 81.52102.6146 TA501 78964	Mercedes Benz 000 429 46 95 Iveco 42535061
weitere/another	



23 500 003 AIR SPRING VALVE	
	TGA TGS TGX
MAN 81.43610.6129 DAF 759050	Iveco 8188642 RENAULT-TRUCKS 5010136105
weitere/another	

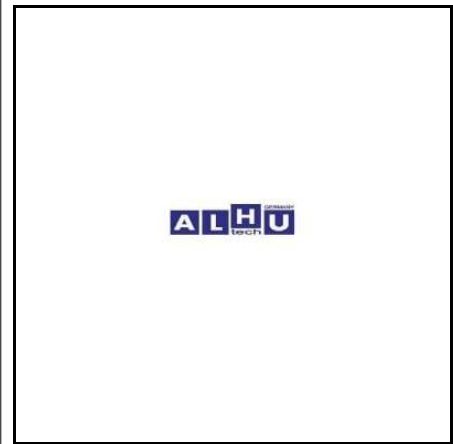

23 500 008 AIR SPRING VALVE	
MAN 84.43610.6006 Mercedes Benz 000 328 23 30	Volvo 1576736 Wabco 464.002.330.0

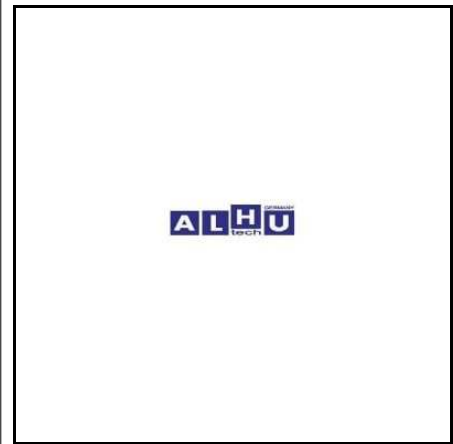

23 500 094 AIR SPRING VALVE	
MAN 81.43610.6054 KNORR I80091	Scania 405674 Volvo 1587153
weitere/another	



Bremse / Brake

23 500 095 AIR SPRING VALVE	
<p>MAN 81.43610.6061</p> <p>KNORR I85698</p>	<p>Scania 426380</p>



63 450 689 AIR TANK	
<p>MAN 81.51401.0129</p>	



63 450 690 AIR TANK	
<p>MAN 81.51401.0133</p>	



63 450 076 AIRCOIL	
<p>black</p>	
<p>MAN 81.96340.0902</p>	



Bremse / Brake

63 451 381 BELLOWS SEAL

MAN
81.96420.0207



63 451 679 BRAKE ANCHOR PLATE



MAN
81.50202.0108

Mercedes Benz
346 421 31 06



06 501 568 BRAKE ANCHOR PLATE

MAN
81.50202.0127

Mercedes Benz
346 423 09 06



22 010 004 BRAKE CAMSHAFT

MAN
81.50301.0223

Mercedes Benz
623 421 01 36



Bremse / Brake

22 010 005 BRAKE CAMSHAFT

MAN
81.50301.0224

Mercedes Benz
623 421 02 36



22 010 006 BRAKE CAMSHAFT

MAN
81.50301.0113

Mercedes Benz
623 423 01 36



22 010 007 BRAKE CAMSHAFT

MAN
81.50301.0112

Mercedes Benz
623 423 02 36



22 010 008 BRAKE CAMSHAFT

MAN
81.50301.0225

Mercedes Benz
305 421 18 36



Bremse / Brake

22 010 009 BRAKE CAMSHAFT

MAN
81.50301.0226

Mercedes Benz
305 421 19 36



22 010 001 BRAKE CAMSHAFT REPAIR KIT

MAN
81.51901.6005



24 420 006 BRAKE CAMSHAFT REPAIR KIT

F 2000

MAN
81.51901.6006



24 106 027 BRAKE CHAMBER

MAN
81.51101.6455

Wabco
423.109.102.0

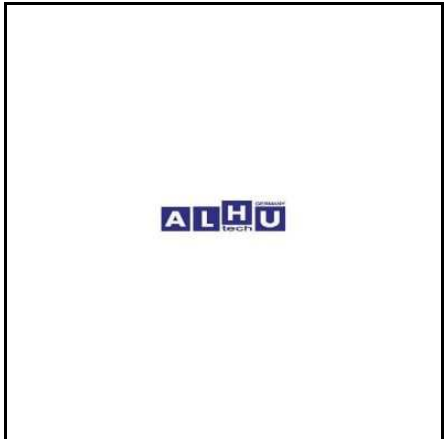

Bremse / Brake

24 106 028 BRAKE CHAMBER

MAN
81.51101.6481

Wabco
423.109.120.0



69 030 000 BRAKE PAD SET

 complete with accessoires **MERITOR** brake

Textar
29030 07



69 202 000 BRAKE PAD SET

 complete with accessoires **KNORR** brake

KNORR
K046771K50

Textar
29202 02



24 420 019 BRAKE SHOE

STEEL, 410 X 160 MM **F 2000**

MAN
81.50201.6190

Mercedes Benz
393 420 25 19



Bremse / Brake

24 420 184	BRAKE SHOE
CAST IRON 180 mm	
TGA TGS TGX	
MAN	
81.50201.6184	
Mercedes Benz	
659 420 06 19	



24 420 188	BRAKE SHOE
CAST IRON 410 x 220 MM	
MAN	
81.50201.6188	



24 420 519	BRAKE SHOE
CAST IRON, 410 x 220 mm	
TGA TGS TGX	
MAN	
81.50201.6218	
Mercedes Benz	
659 420 05 19	



22 001 002	BRAKE SHOE PIN
MAN	
81.50212.0036	
Mercedes Benz	
497 421 00 74	



Bremse / Brake

22 001 003 BRAKE SHOE PIN REPAIR KIT

MAN
81.50212.0036S



22 000 031 BRAKE SHOE SPRING

MAN
81.97610.0317



22 000 032 BRAKE SHOE SPRING

MAN
81.97610.0208

Mercedes Benz
617 993 06 10



63 451 352 BRAKE SHOE SPRING PIN

MAN
81.50211.0018



Bremse / Brake

13 815 004 BRAKE WEAR INDICATOR

F 2000

MAN
81.50811.0004

KÄSSBOHRER
82823884510

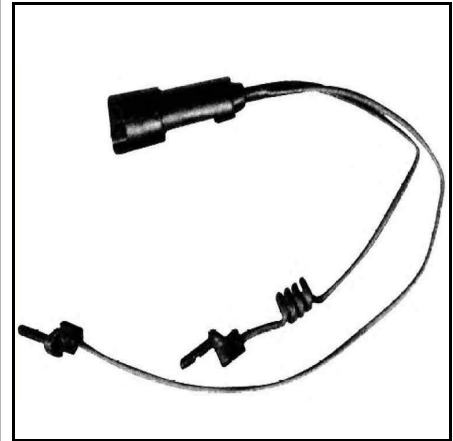

13 815 012 BRAKE WEAR INDICATOR

MAN
81.50822.6017

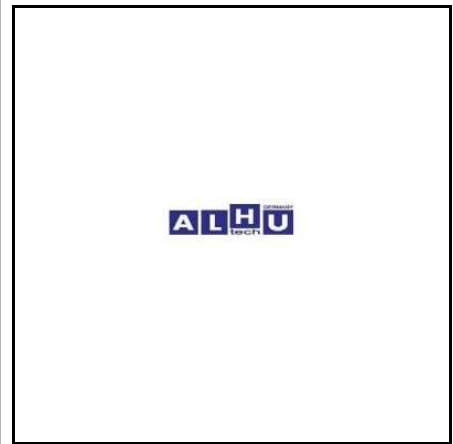

13 815 013 BRAKE WEAR INDICATOR

F 2000

MAN
81.50822.6013



13 815 015 BRAKE WEAR INDICATOR

L 2000 M 2000

MAN
81.50822.6015
81.50822.6029

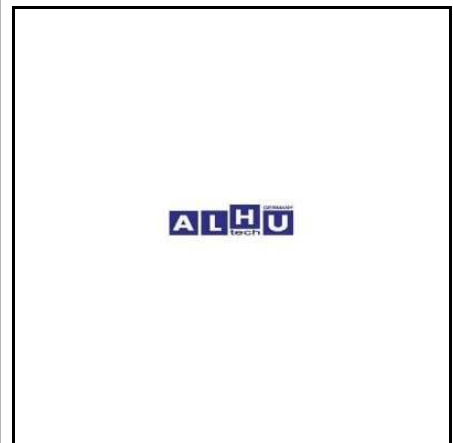

Bremse / Brake

13 815 022 BRAKE WEAR INDICATOR

F 2000

MAN
81.25937.6012



13 815 601 BRAKE WEAR INDICATOR

F 2000

MAN
81.25937.6011



13 815 011 BRAKE WEAR INDICATOR KIT
not complete

F 2000 TGA

MAN
81.50822.6016



13 815 014 BRAKE WEAR INDICATOR KIT
without back-plate

L 2000 M 2000

MAN
81.50822.6014

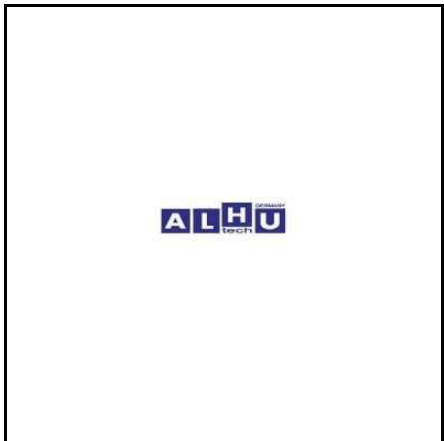

Bremse / Brake

22 420 007 CALIPER BOLT REPAIR KIT

F 2000

MAN 81.50802.6009	Mercedes Benz 000 420 02 76
TA501 SJ 4011	



22 420 005 CALIPER BOLT REPAIR KIT

F 2000 TGA TGS TGX

MAN 81.50802.6025	
TA501 MCK1243	



22 420 008 CALIPER COVER SET

MAN 81.50802.6007	Mercedes Benz 000 423 00 82
TA501 SJ 1212	



63 450 816 CONTAINER VALVE

MAN 81.43610.6134	HALDEX 338021001
Mercedes Benz 000 329 08 25	KNORR I83153

weitere/another



Bremse / Brake

22 937 015 ECAS HEIGHT SENSOR

MAN 81.25937.0015	Mercedes Benz 010 542 78 17
DAF 1247631	Wabco 441.050.008.0



22 937 016 ECAS HEIGHT SENSOR

MAN 81.25937.0016	Scania 1398840
DAF 1305844	Wabco 441.050.011.0



63 450 795 ECAS HEIGHT SENSOR



MAN 81.25937.0014	
Wabco 441.050.006.0	



63 450 796 ECAS HEIGHT SENSOR



MAN 81.25937.0040	Wabco 441.050.120.0
Mercedes Benz 002 542 67 18	



Bremse / Brake

22 902 175 ECAS VALVE REPAIR KIT

MAN
81.25902.6175

Wabco
472.905.004.2

Mercedes Benz
000 320 13 58

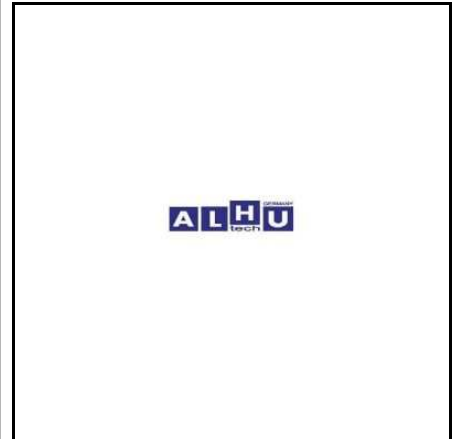

24 013 116 ENGINE STOP VALVE

MAN
81.52185.6018

KNORR
I75794

Mercedes Benz
000 434 21 01

Neoplan
110208

weitere/another



63 450 242 FOLLOWER

MAN
51.54206.0004



24 000 004 FOOT BRAKE VALVE

MAN
81.52130.6149
81.52130.6222

KNORR
I130848

TA501
320060112

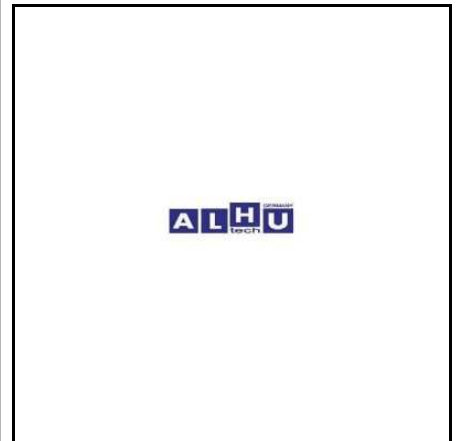

Bremse / Brake

24 000 005 FOOT BRAKE VALVE	
MAN 81.52130.6192 81.52130.6218	KNORR II19090
TA501 320060101	



24 000 006 FOOT BRAKE VALVE	
MAN 81.52130.6148 81.52130.6150 81.52130.6219	HALDEX 320060102
TA501 320060102	KNORR II36299



63 450 199 FOOT BRAKE VALVE	
MAN 81.52130.6106	
Wabco 461.315.086.0	



63 451 123 FOOT BRAKE VALVE	
MAN 81.52130.6129 81.52130.6130	
Wabco 461.315.089.0	



Bremse / Brake

24 430 118 HAND BRAKE VALVE

MAN
81.52315.6156

Wabco
961.723.118.0



63 450 198 HAND BRAKE VALVE

MAN
81.52315.6086
81.52315.6090

Wabco
961.722.262.0

KNORR
I92190



22 722 004 HAND BRAKE VALVE REPAIR KIT

MAN
81.52315.6106

Wabco
961.722.004.2

Mercedes Benz
003 430 33 81



21 203 009 HOSE PIPE

MAN
06.54099.0124



Bremse / Brake

63 450 092 HOSE PIPE

MAN
06.54059.0012



24 500 020 LINE FILTER, COMPRESSOR SYSTEM

MAN 81.51270.6026	HALDEX 310005011
Mercedes Benz 000 429 29 95	Wabco 432.500.020.0



24 000 003 LOAD SENSING VALVE

MAN
81.43618.6008

Wabco
433.302.026.0



22 420 004 PISTON RETAINING PLATE

MAN
81.50822.0006

TA501
68321678



Bremse / Brake

22 015 004 PRESSURE LIMITER VALVE

MAN 81.52101.6153	Wabco 475.015.004.0
Mercedes Benz 001 431 63 06	



24 000 007 PRESSURE LIMITER VALVE

MAN 81.52101.6269	
Wabco 475.010.300.0	



24 000 008 PRESSURE LIMITER VALVE

MAN 81.52101.6270	
Wabco 475.010.301.0	



63 451 124 PRESSURE LIMITER VALVE

MAN 81.52101.6022 81.52101.6073	KNORR 0481039202000
Mercedes Benz 001 431 41 06 001 431 43 06	Wabco 975.303.447.0



Bremse / Brake

63 451 004 PRESSURE LIMITING VALVE

MAN
81.52101.6283

Wabco
475.010.314.0

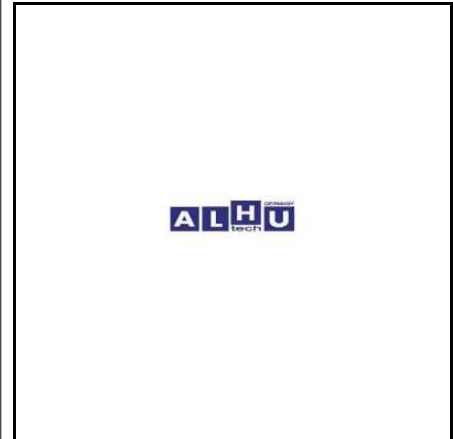

24 303 473 PRESSURE REGULATOR

MAN
81.52101.6076

Iveco
4842611

Mercedes Benz
001 431 00 06
002 431 43 06

KHD
2516923

weitere/another



24 303 474 PRESSURE REGULATOR

MAN
84.52101.6017

Mercedes Benz
003 431 36 06

Bosch
0 481 039 209

Wabco
975.303.474.0



22 116 075 RELAY VALVE

MAN
81.52116.6075

Wabco
973.006.003.0

Mercedes Benz
004 429 63 44

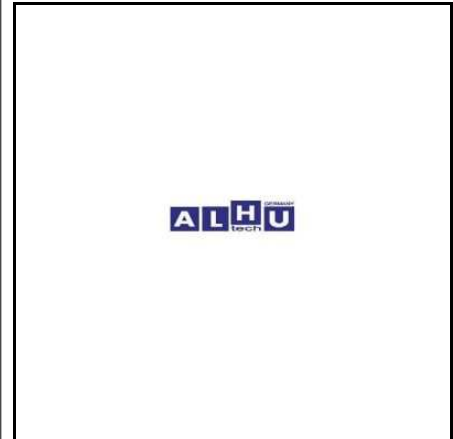

Bremse / Brake

24 001 100 RELAY VALVE

MAN 81.43609.6008	KHD 42030573
Mercedes Benz 000 429 65 44	KNORR 176792

weitere/another



24 001 200 RELAY VALVE

MAN 81.52116.6022	Mercedes Benz 001 429 68 44 002 429 92 44
Bosch 0 481 026 005	Neoplan 110205

weitere/another



24 001 221 RELAY VALVE

MAN 81.52150.6011	
KNORR RE 1141	



63 450 152 RELAY VALVE

MAN 81.52116.6070	KNORR K008490
Mercedes Benz 004 429 38 44	Wabco 973.011.001.0

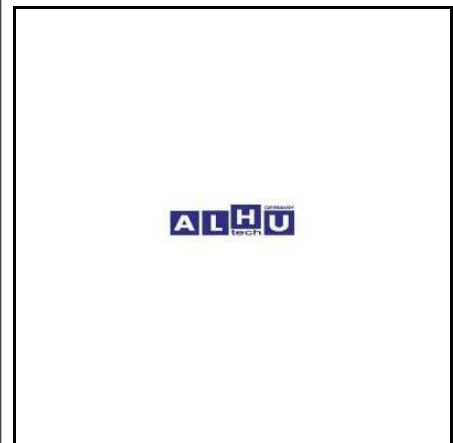

Bremse / Brake

63 450 244 RELIEF VALVE

D 2866 D 2876

MAN
51.54122.0007

KNORR
I99812



63 451 125 REPAIR KIT

MAN
81.52130.6104

Wabco
461.315.005.2

Mercedes Benz
001 430 04 60



24 420 022 REPAIR KIT RUBBER BUSH

MAN
81.50802.6022

Meritor
MCK1103



22 420 944 REPAIR KIT, BRAKE CALIPER

TGA TGS TGX

MAN
81.50822.6032

KNORR
K000944

Mercedes Benz
000 420 06 82
000 420 39 82



Bremse / Brake

22 420 102 REPAIR KIT, BRONZE BUSHING

F 2000 TGA TGS TGX

MAN
81.50802.6021

TA501
MCK1102

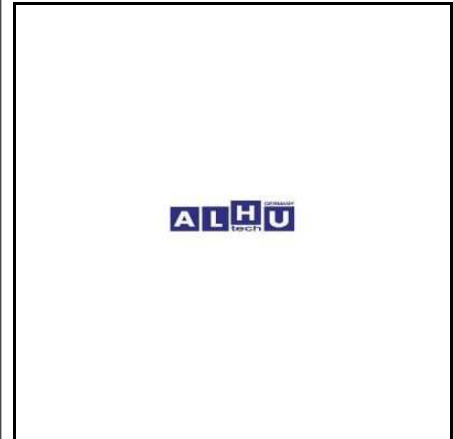

24 300 000 REPAIR KIT, UNLOADER VALVE

MAN
81.52101.6118

Wabco
975.300.000.2

Mercedes Benz
000 430 11 07



24 002 107 SHUT-OFF VALVE

MAN
81.51230.6009

KNORR
I28323

Mercedes Benz
000 429 16 31

Wabco
452.002.107.0



24 407 060 SILENCER

MAN
81.52101.6274

Wabco
432.407.060.0

Mercedes Benz
000 430 23 70

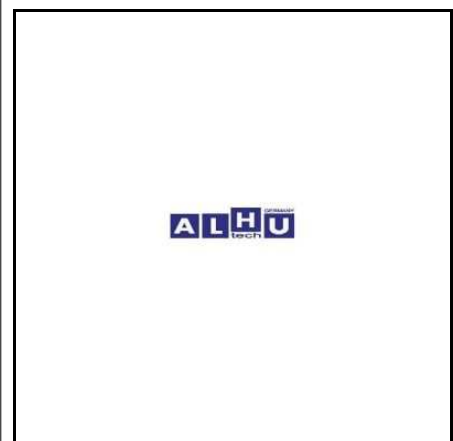

Bremse / Brake

24 407 070 SILENCER

MAN
81.52101.6275

Wabco
432.407.070.0



24 407 071 SILENCER

MAN
81.52101.6264

Wabco
432.407.012.0

Mercedes Benz
000 430 20 70



22 420 210 SLACK ADJUSTER
right

MAN
81.50610.6210



22 420 211 SLACK ADJUSTER
left

MAN
81.50610.6211



Bremse / Brake

63 451 116 SLACK ADJUSTER

MAN
81.50610.6220

HALDEX
79223C



63 451 117 SLACK ADJUSTER

MAN
81.50610.6222



63 451 145 SLACK ADJUSTER

MAN
81.50610.6266



63 453 049 SLACK ADJUSTER

MAN
81.50610.6221

HALDEX
79224C



Bremse / Brake

24 420 092 SLACK ADJUSTER KIT	
<p>MAN 81.50610.6132</p> <p>Mercedes Benz 000 420 00 92</p>	<p>RENAULT-TRUCKS 5001825536</p> <p>Scania 324728 324729 1350817</p> <p style="text-align: right;">weitere/another</p>



22 160 087 SOLENOID VALVE	
<p>MAN 81.52160.6087</p> <p>Wabco 472.132.198.0</p>	

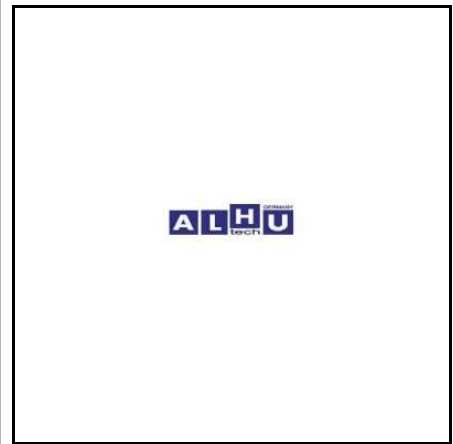

63 450 764 SPEED SENDER	
<p>MAN 51.27120.7038</p> <p>Bosch 0 281 002 662</p>	

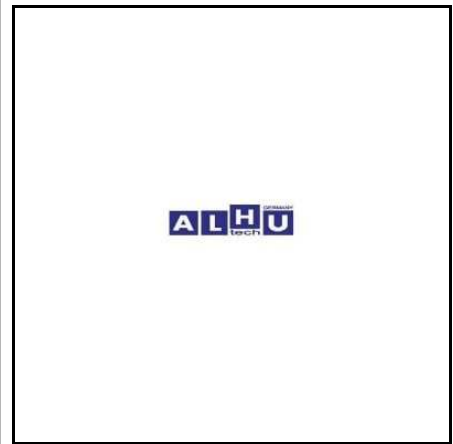

21 271 008 SPEED SENSOR	
<p>MAN 51.27120.0008</p> <p>Bosch 0 281 002 270</p>	

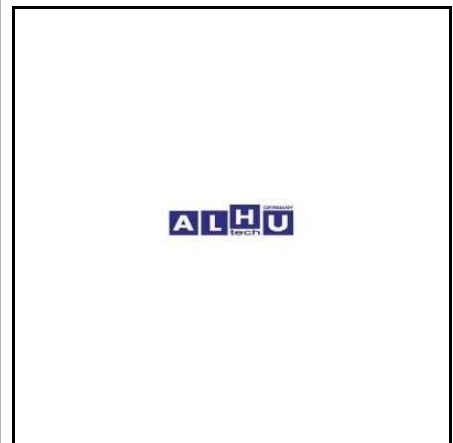

Bremse / Brake

21 271 009 SPEED SENSOR

MAN
51.27120.0009

Bosch
0 281 002 271

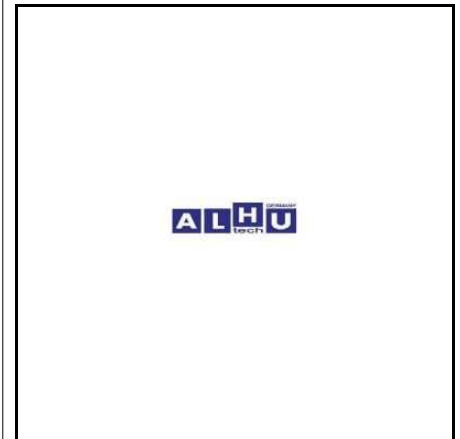

21 271 014 SPEED SENSOR

MAN
51.27120.0014

Bosch
0 281 002 426

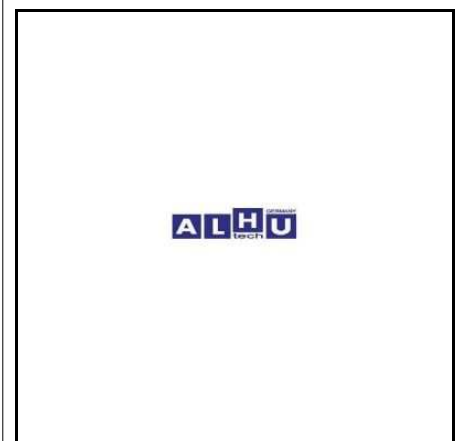

21 271 015 SPEED SENSOR

MAN
51.27120.0015

Bosch
0 281 002 427

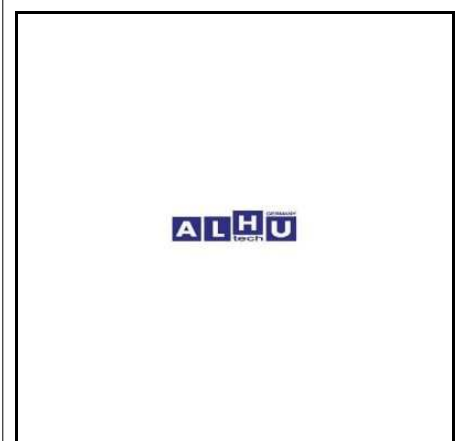

22 610 265 SPRING

MAN
81.97610.0265

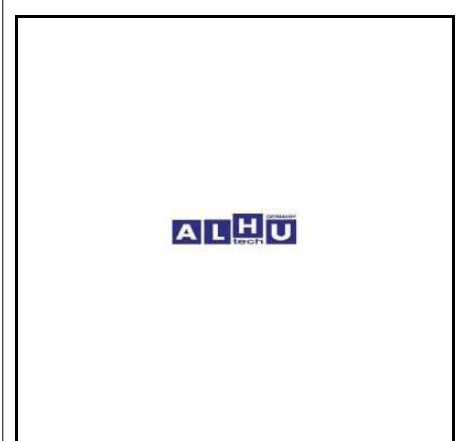

Bremse / Brake

63 451 384 SPRING

MAN
81.97610.0224



63 451 385 SPRING

MAN
81.97610.0271



63 451 386 SPRING

MAN
81.97610.6013



23 410 118 SPRING BRAKE CYLINDER

MAN
81.50410.6118

KNORR
BZ 6621 AFM



Bremse / Brake

63 450 824 SPRING RETAINING PIN

MAN
81.50211.0027

Mercedes Benz
387 421 00 74
658 421 00 74

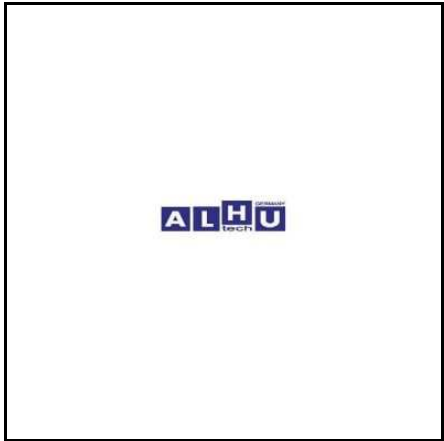

22 420 006 TAPPET HEAD REPAIR KIT

F 2000 TGA TGS TGX

MAN
81.50802.6024

Meritor
MCK1139



63 450 814 TAPPETS KIT

MAN
81.50822.6031

KNORR
K010603



24 002 210 TRAILER CONTROL VALVE

MAN 81.52301.6165	KNORR 0481061219000
Mercedes Benz 002 431 01 05	Wabco 973.002.521.0



Bremse / Brake

22 420 001 YOKE

MAN
06.36064.0164



24 170 156 3/2 WAY VALVE

F 2000

MAN
81.52170.6156



22 400 006 4-CIRCUIT PROTECTION VALVE

MAN
N1.01106.6148

Wabco
934.714.125.0

KNORR
II38801F



63 450 191 4-CIRCUIT PROTECTION VALVE



MAN
81.52151.6073

KNORR
II 18172



Diverse / Diverse

8.8M12X1.5X30 CHEESE HEAD SCREW DIN 912

MAN
06.02099.0204

Mercedes Benz
000 912 01 20 47



63 450 119 CLEVIS PIN
steel DIN 1444

MAN
06.21569.0066



63 450 128 CLEVIS PIN
steel DIN 1444

MAN
06.21569.0077



23 000 015 CYLINDER LOCK SCREW

MAN
81.90030.0146



Diverse / Diverse

23 000 007 CYLINDER SCREW

MAN
06.02191.2923



M10X45 CYLINDER SCREW
DIN 912

MAN
06.02099.0351



M14X1.5 DRAIN PLUG

MAN
06.08042.0603



66 220 002 DRAIN PLUG
 M16X1.5 ST

MAN
06.08042.0604



Diverse / Diverse

G 1/2 A DRAIN PLUG DIN 908

MAN
06.08049.0028

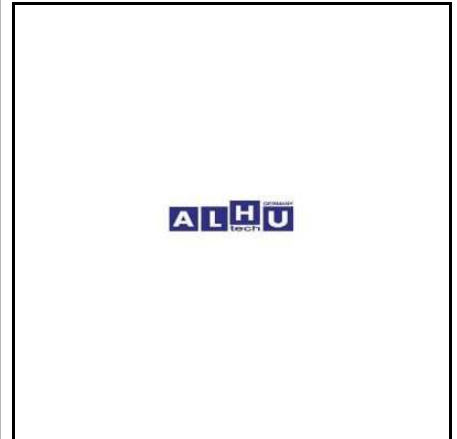

23 000 001 FITTED BOLT

MAN
81.90001.0414



20 001 005 FLAT COLLAR NUT

MAN
06.11251.2005

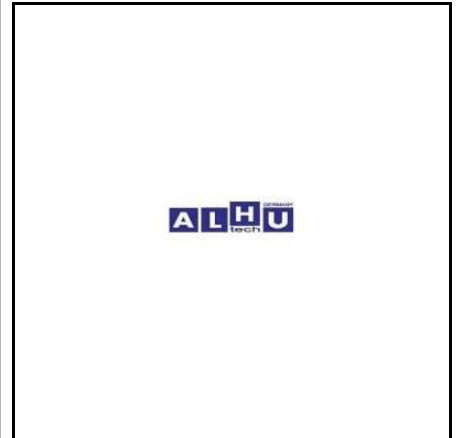

20 001 108 FLAT COLLAR NUT

MAN
06.11251.8108



Diverse / Diverse

23 000 014 HEX BOLT

MAN
06.01733.4921



23 000 002 HEX COLLAR BOLT

MAN
06.02202.1013

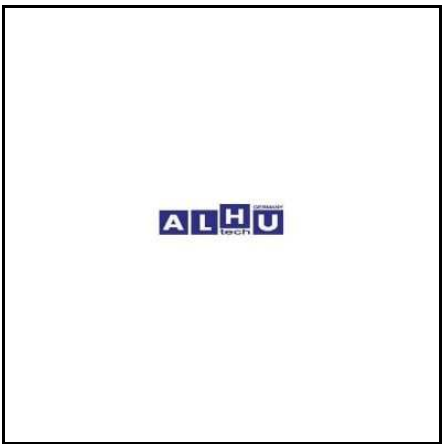

63 450 593 HEX COLLAR BOLT

MAN
06.02202.4212

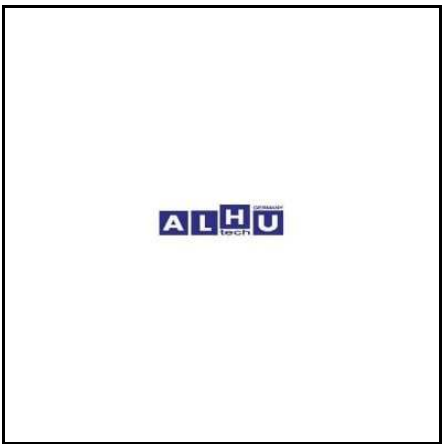

AM 16X1.5 HEX LOCK NUT

MAN
06.11241.0317

Mercedes Benz
913 004 01 60 05

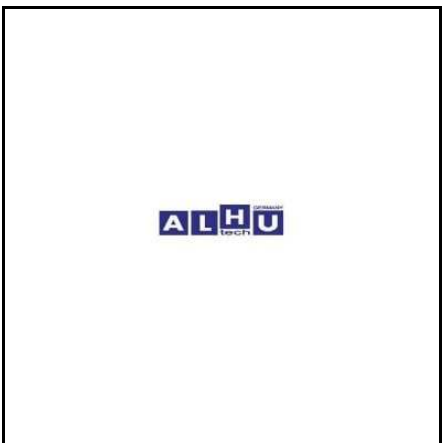

Diverse / Diverse

20 000 912 HEX LOCK SCREW

MAN
06.02813.4912

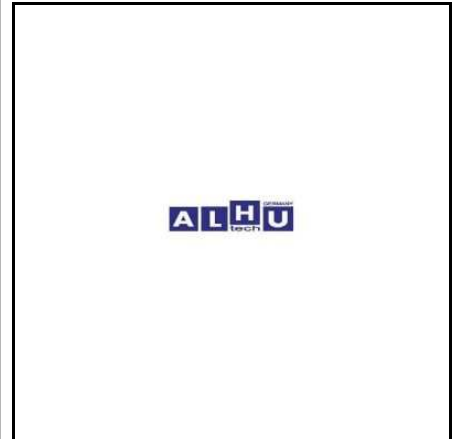

23 000 003 HEX SHOULDER SCREW

MAN
06.01494.4734



23 000 005 HEX SHOULDER SCREW

MAN
06.01494.6724



23 000 006 HEX SHOULDER SCREW

MAN
06.01493.4730

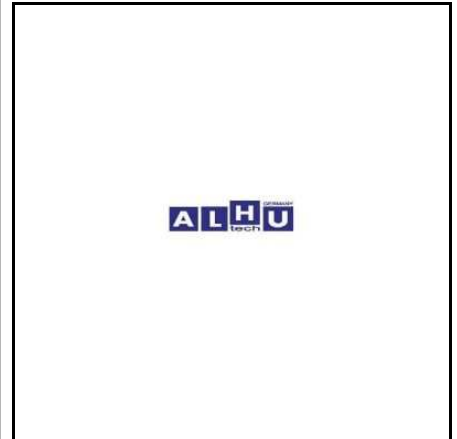

Diverse / Diverse

23 000 008 HEX SHOULDER SCREW

MAN
06.01499.0173



23 000 009 HEX SHOULDER SCREW

MAN
06.01494.4718



23 000 010 HEX SHOULDER SCREW

MAN
06.01493.4740



23 000 013 HEX SHOULDER SCREW

MAN
06.01493.4925



Diverse / Diverse

20 000 933 HEX SHOULDER STUD

MAN
06.01494.6933



20 000 935 HEX SHOULDER STUD

MAN
06.01494.4935



23 000 004 HEX SHOULDER STUD

MAN
06.01493.4719



23 000 011 HEX SHOULDER STUD

MAN
06.01493.4733

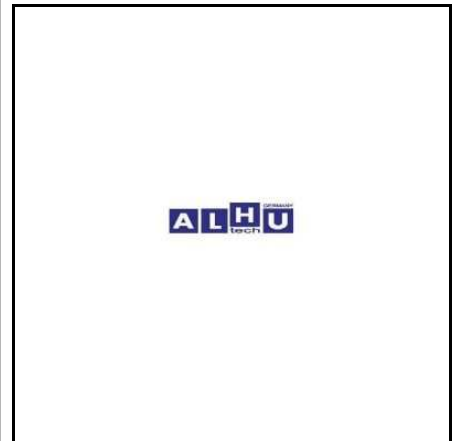

Diverse / Diverse

23 000 012 HEX SHOULDER STUD

MAN
06.01493.4725



66 220 006 HEX SHOULDER STUD
DIN 960 | 10.9 M16X1.5X170

MAN
06.01494.6526



63 450 594 HEX SHOULDER STUD DIN 960

MAN
06.01493.4932

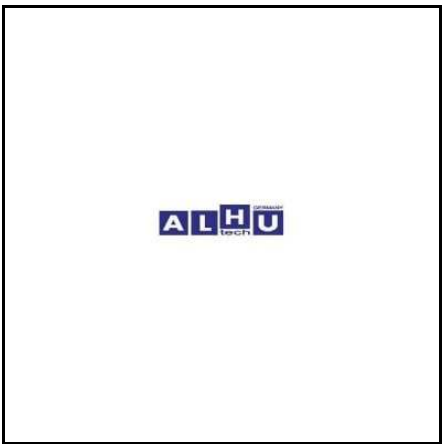

66 220 007 HEX SHOULDER STUD M10X80 8.8
DIN 931

MAN
06.01013.7221

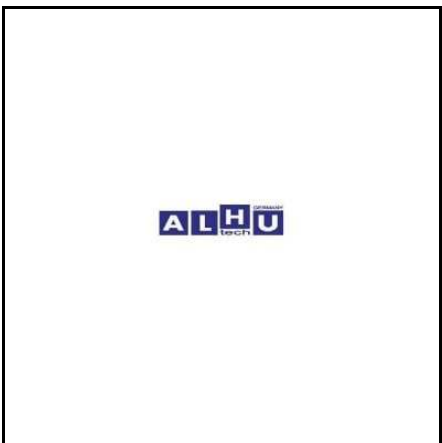

Diverse / Diverse

20 000 936 HEX SHOULDER STUD 10.9

MAN
06.01494.6511



M14X1.5 HEXAGON NUT DIN 934

MAN
06.11065.2317



CHF11S HYDRAULIC OIL 1 LITRE TIN

MAN 09.11003.0427	BMW 81 22 9 407 758 83 29 0 429 576
Diverse TA800 CHF11S	VW G 002 000



63 450 591 LOCK SCREW

MAN
06.02819.0005

Mercedes Benz
914 112 01 43 13



Diverse / Diverse

63 450 592 LOCK SCREW

MAN
06.02816.1413

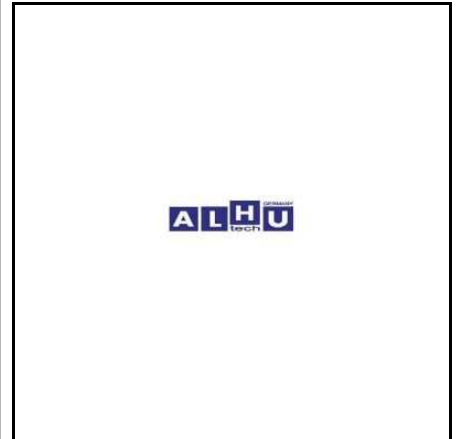

63 450 588 LOCKING PIN

MAN
06.43809.0176

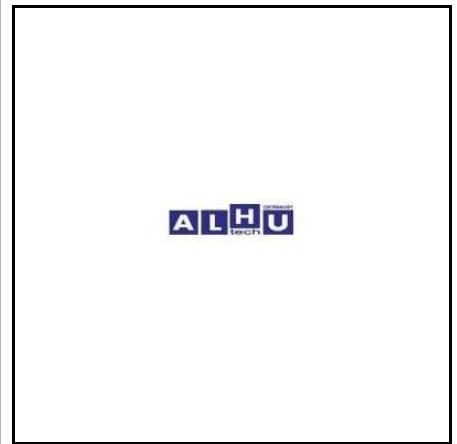

20 000 013 TENSILOCK SCREW

MAN
06.02813.5013

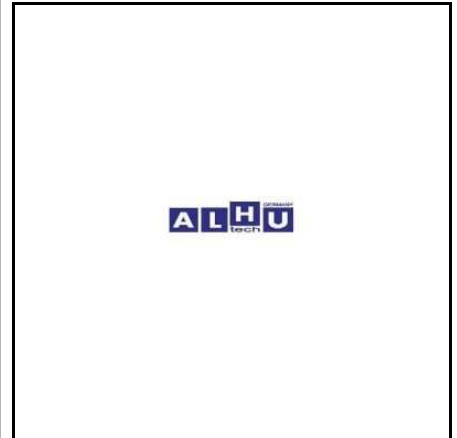

20 000 015 TENSILOCK SCREW

MAN
06.02815.9015



Diverse / Diverse

20 000 017 TENSILOCK SCREW

MAN
06.02815.9017



20 000 022 TENSILOCK SCREW

MAN
06.02815.9022



20 000 812 TENSILOCK SCREW

MAN
06.02815.8812



20 000 911 TENSILOCK SCREW

MAN
06.02815.8911

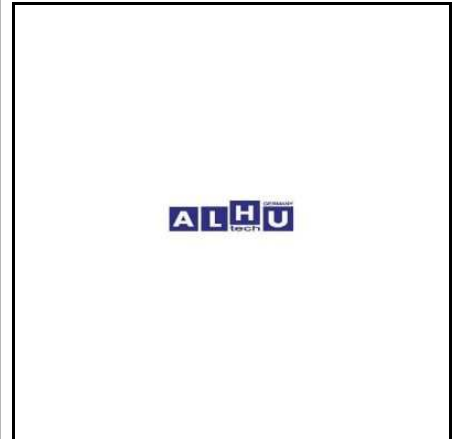

Diverse / Diverse

20 000 913 TENSILOCK SCREW

MAN
06.02815.8913



20 000 914 TENSILOCK SCREW

MAN
06.02815.8914



20 000 915 TENSILOCK SCREW

MAN
06.02813.4915



20 000 916 TENSILOCK SCREW

MAN
06.02813.4916



Diverse / Diverse

20 000 917 TENSILOCK SCREW

MAN
06.02815.8917



20 000 919 TENSILOCK SCREW

MAN
06.02813.4919

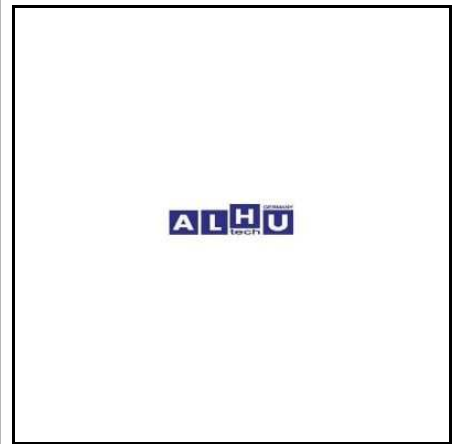

Elektrik / Electric

21 325 500 ALTERNATOR

MAN
51.26101.7266
51.26101.9266

Bosch
0 123 325 500



21 468 053 ALTERNATOR
28 V

MAN
51.26101.7192

Mercedes Benz
007 154 92 02

Bosch
0 120 468 053
0 120 468 107



21 469 982 ALTERNATOR
10/55 A

MAN
51.26101.7201

Mercedes Benz
009 154 07 02

Bosch
0 120 469 982



21 488 291 ALTERNATOR
28 V,35 A with fan

MAN
51.26101.7215

Mercedes Benz
009 154 15 02

Bosch
0 120 488 291



Elektrik / Electric

21 489 728 ALTERNATOR
27 A

MAN
51.26101.7148

Mercedes Benz
007 154 90 02

Bosch
0 120 489 728

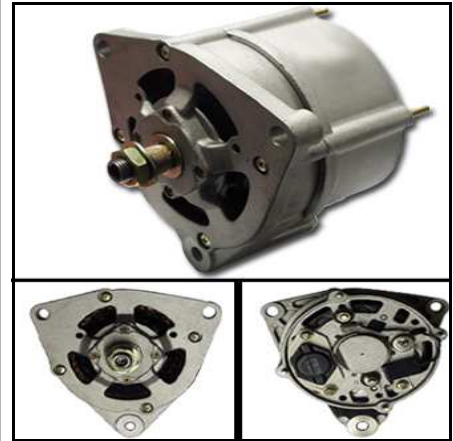

21 525 501 ALTERNATOR

MAN
51.26101.7265
51.26101.9265

Bosch
0 123 525 501

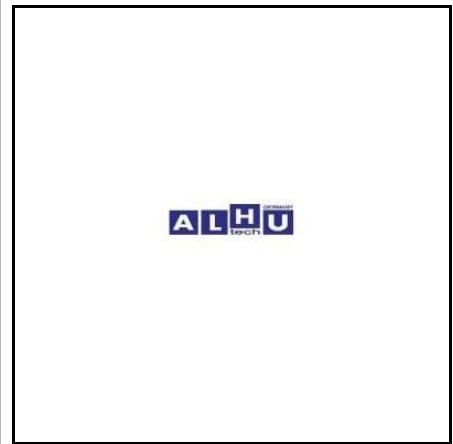

21 555 013 ALTERNATOR
28 V,80 A

MAN
51.26101.7271
51.26101.9271

Bosch
0 124 555 013
0 986 047 420

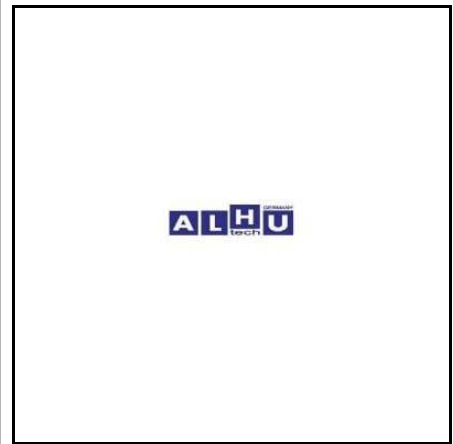

21 555 014 ALTERNATOR

MAN
51.26101.7269
51.26101.9269

Bosch
0 124 555 014

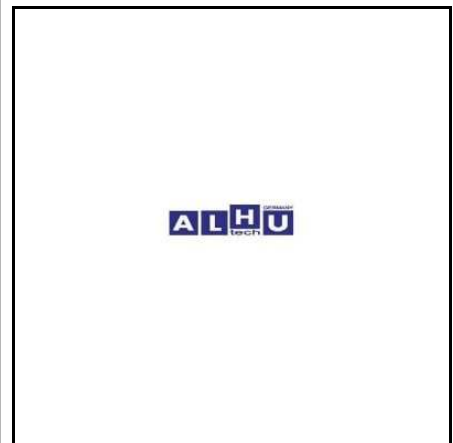

Elektrik / Electric

21 655 009 ALTERNATOR

MAN
51.26101.7270
51.26101.9270

Bosch
0 124 655 009



21 655 011 ALTERNATOR

MAN
51.26101.7268

Bosch
0 124 655 011



21 689 541 ALTERNATOR
70/140 AMPERE

MAN
81.26101.6084

Mercedes Benz
011 154 96 02

Bosch
0 120 689 569



21 005 022 ARMATURE
KB24 Volt-5,4 KW

MAN
81.26203.6018

DAF
697876

Bosch
2 004 005 037
2 004 005 153

Mercedes Benz
000 151 40 15



Elektrik / Electric

21 005 023 ARMATURE

MAN 81.26203.6019 81.26203.6020	Scania 353381
Bosch 2 004 005 023	



21 005 025 ARMATURE

MAN 81.26203.6007	Mercedes Benz 000 151 39 15
Bosch 2 004 005 025	



21 014 052 CARBON BRUSH SET

MAN A5.00024.0938	Mercedes Benz 000 151 54 14
Bosch 2 007 014 052	Scania 292896

weitere/another



21 014 070 CARBON BRUSH SET

MAN 81.25921.6051	Mercedes Benz 000 151 89 14
Bosch 2 007 014 061 2 007 014 070	Scania 313201

weitere/another

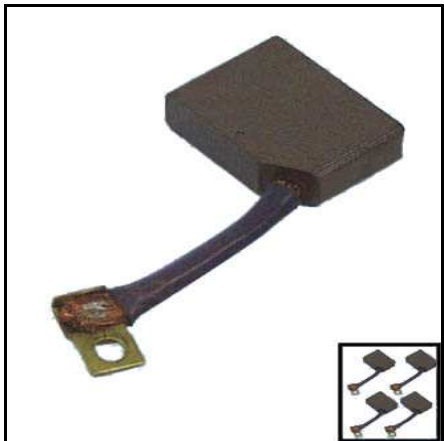

Elektrik / Electric

21 014 079 CARBON BRUSH SET

MAN 81.25921.6058	Mercedes Benz 001 151 32 14
Bosch 2 007 014 079	



25 545 060 CENTRAL ELECTRIC

MAN
81.25444.6060



25 545 074 CENTRAL ELECTRIC

TGA

MAN
81.25444.6074



21 880 166 COMMUTATOR END SHIELD

MAN
81.26207.0021



Elektrik / Electric

25 545 497 CONTROL UNIT, GLOW PLUG SYSTEM

MAN

81.25902.0441
81.25902.0497



21 825 071 DRIVE BEARING, STARTER

MAN

90.81690.1173



21 825 218 DRIVE BEARING, STARTER

MAN

81.26215.6014

Bosch

2 005 825 218



21 003 040 ENGAGEMENT ROD

MAN

81.26214.0003

Scania

353384

Bosch

2 003 050 040

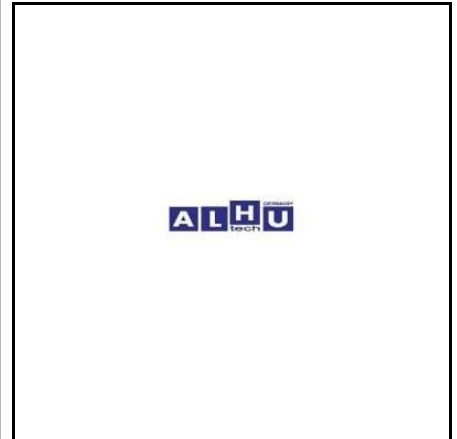

Elektrik / Electric

21 004 036 FIELD COIL	
MAN 81.26204.0013 Bosch 2 004 125 036	RENAULT-TRUCKS 7701008182 Scania 220365 weitere/another



21 004 078 FIELD COIL	
MAN 81.26204.0032 Bosch 2 004 125 078	Mercedes Benz 000 151 70 55 weitere/another

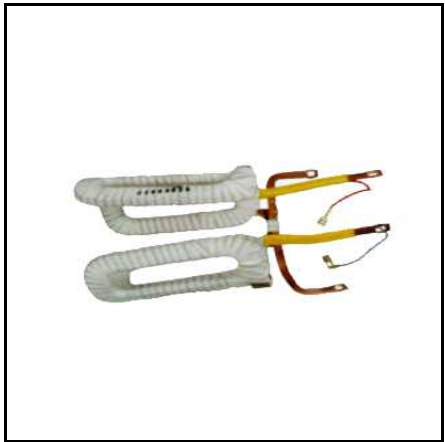

21 004 083 FIELD COIL	
MAN 81.26204.0033 Bosch 2 004 125 083	Mercedes Benz 000 151 80 55 Iveco 8198726 weitere/another

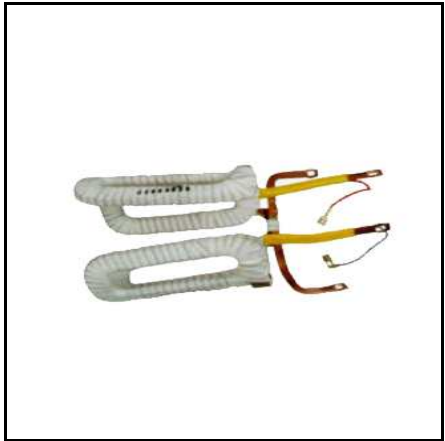

25 542 120 HORN 24V, 335 HZ	
MAN 81.25301.6066 Bosch 0 986 320 301	Mercedes Benz 002 542 67 20 KHD 42047451

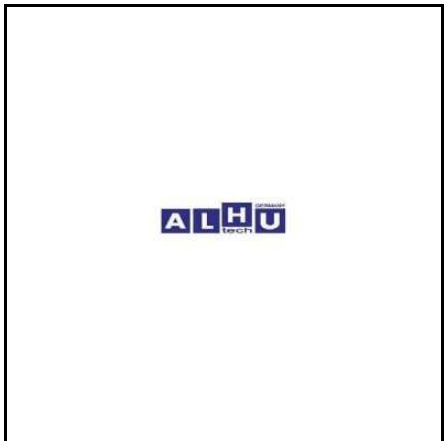

Elektrik / Electric

25 215 002 INDICATOR RELAY	
MAN 88.25310.6002	Mercedes Benz 002 544 79 32
Bosch 0 335 215 154	Volvo 1582410



25 215 006 INDICATOR RELAY	
MAN 81.25311.0006	



25 215 350 INDICATOR RELAY	
MAN 81.25311.0005	



25 215 450 INDICATOR RELAY	
MAN 81.25311.0023	



Elektrik / Electric

25 215 550 INDICATOR RELAY	
MAN 81.25310.0034	Mercedes Benz 002 544 80 32
Bosch 0 335 215 143	Volvo 1501686 1587993



25 545 519 LOAD RELAY	
MAN 81.25902.0519	



63 451 653 RECTIFIER	
 MAN 81.26109.0014	Mercedes Benz 001 154 12 16
Bosch 1 127 320 961	



21 127 097 RECTIFIER ASSY	
Bosch 1 127 011 098	Mercedes Benz 000 154 58 16
DAF 694065	KHD 1309115



Elektrik / Electric

63 453 042 RECTIFIER ASSY



MAN 81.26109.0018	Mercedes Benz 001 154 21 16
Bosch 1 127 320 989	Volvo 3090260 3090262



25 545 107 RELAIS

MAN
81.25927.0107



25 545 376 RELAIS

MAN
81.25902.0376



25 545 410 RELAIS

MAN
81.25902.0410



Elektrik / Electric

25 545 469 RELAIS

MAN
81.25902.0469



25 545 473 RELAIS

MAN
81.25902.0473

Bosch
0 332 019 204
0 332 019 213



25 545 474 RELAY, 2-WAY CONTACT

MAN
81.25902.0474

Bosch
0 332 209 216



63 450 236 REPAIR KIT

MAN
81.26100.6029

Bosch
1 127 011 166



Elektrik / Electric

21 101 006 SOLENOID SWITCH	
MAN 81.26212.0011	DAF 252120
Bosch 0 331 101 006	Mercedes Benz 000 152 40 10
weitere/another	

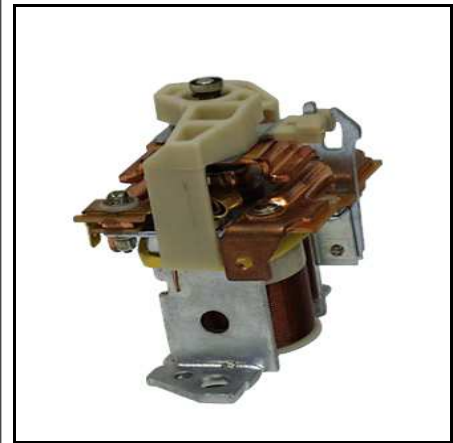

21 450 001 SOLENOID SWITCH	
MAN 81.26212.0012 81.26212.0017	DAF 252121
Bosch 0 331 450 001	Mercedes Benz 000 152 42 10 000 152 89 10
weitere/another	

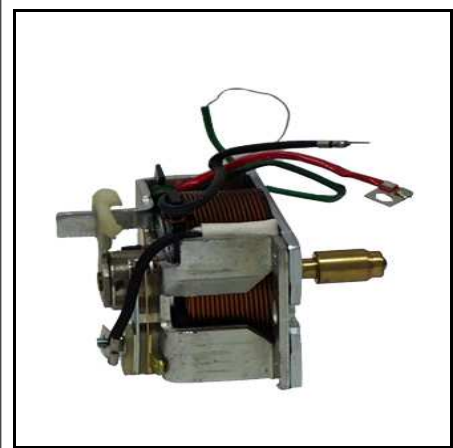

25 545 478 SPEED SENSOR	
MAN 81.25902.0378	

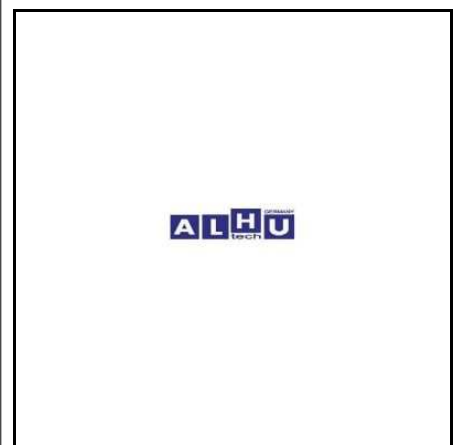

21 301 043 STARTER BUSHING	
18x14x13,8 mm	
Bosch 2 000 301 043	KHD 1308147
Mercedes Benz 000 151 35 50	Scania 313263



Elektrik / Electric

21 401 527 STARTER CLUTCH

MAN 81.26225.6003	DAF 244606
Bosch 2 006 401 527	Mercedes Benz 000 151 06 33

weitere/another



29 542 819 STARTER INTERLOCK

MAN 81.25902.0203	Mercedes Benz 001 542 48 19
Bosch 0 331 801 300	

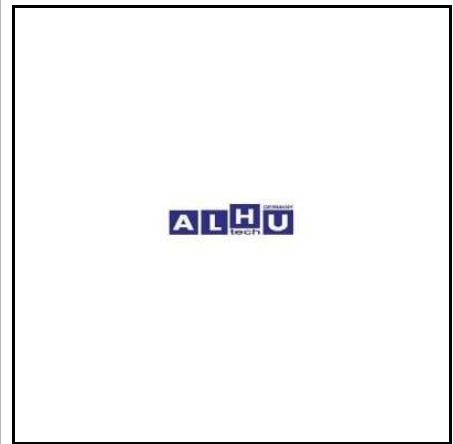

21 231 030 STARTER MOTOR

MAN 51.26201.7213 51.26201.9213	
Bosch 0 001 231 030	

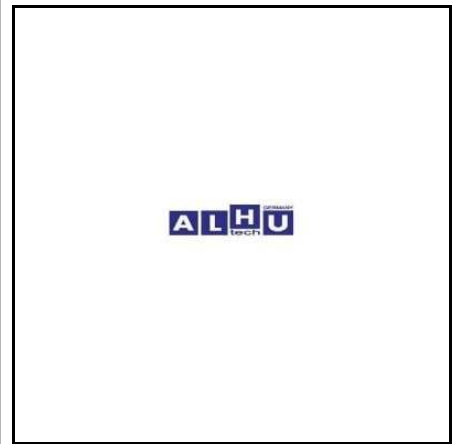

21 416 022 STARTER MOTOR

MAN 51.26201.7112	Mercedes Benz 003 151 95 01
Bosch 0 001 416 022	



Elektrik / Electric

21 416 024 STARTER MOTOR

MAN 51.26201.7074	Mercedes Benz 003 151 60 01
Bosch 0 001 416 024	



21 417 001 STARTER MOTOR
24 V - 6,6 KW

MAN 51.26201.7123	Mercedes Benz 004 151 61 01 005 151 28 01
Bosch 0 001 411 009 0 001 417 001	



21 431 002 STARTER MOTOR
24V - 5,4 KW

MAN 51.26201.7159	Mercedes Benz 004 151 60 01
Bosch 0 001 416 002 0 001 416 078 0 986 011 570	



63 453 010 STARTER MOTOR

new

MAN
51.26201.7231

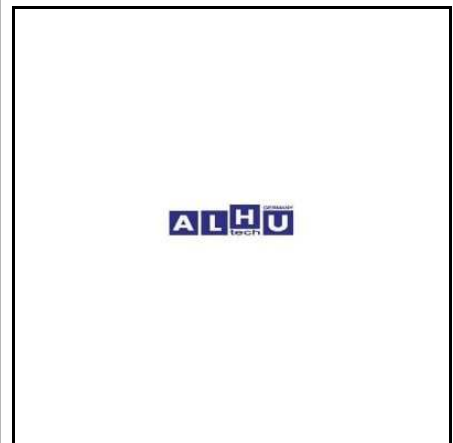

Elektrik / Electric

21 006 020 STARTER PINION	
MAN 81.26209.0015 Bosch 2 006 382 176	Mercedes Benz 001 151 05 13



21 209 422 STARTER PINION	
MAN 81.26209.0016 Bosch 2 006 209 422	Mercedes Benz 000 151 66 13



21 301 015 STARTER SHAFT BUSHING	
48x40x10,3 mm	
MAN 81.93020.0427 Bosch 2 000 301 015	DAF 573329 Mercedes Benz 000 151 40 50



21 301 016 STARTER SHAFT BUSHING	
28x22x11,3 mm	
MAN 81.93020.0428 Bosch 2 000 301 016	Mercedes Benz 000 151 41 50



Elektrik / Electric

21 144 122 VOLTAGE REGULATOR



MAN
51.25601.0006

Bosch
F 00M 144 122

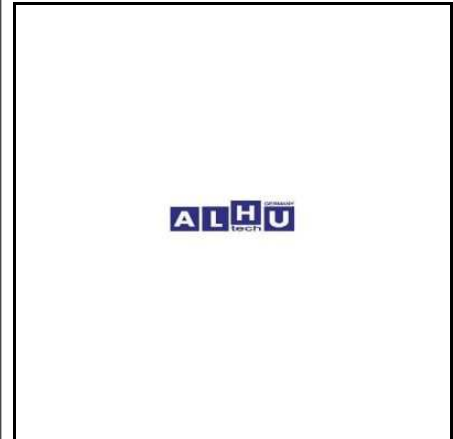

21 192 005 VOLTAGE REGULATOR

28 V

MAN
81.25601.0011

Mercedes Benz
001 154 88 06

Bosch
0 192 033 005

KHD
1162829



21 192 014 VOLTAGE REGULATOR

28 VOLT

MAN
81.25601.6030

Mercedes Benz
002 154 96 06

Bosch
0 192 053 014
1 197 311 315



21 311 301 VOLTAGE REGULATOR

28 VOLT

MAN
81.25601.6035

Iveco
93158421

Mercedes Benz
000 154 17 05
002 154 17 05
002 154 84 06

Scania
1117253

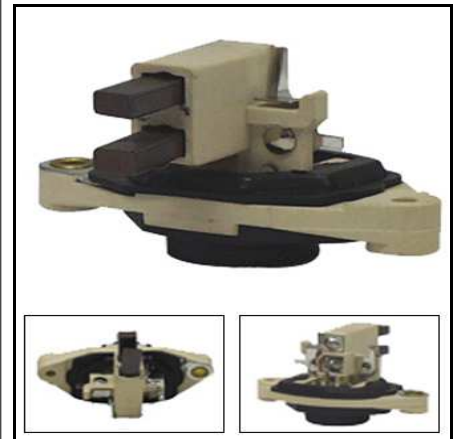

Elektrik / Electric

21 311 558 VOLTAGE REGULATOR

MAN
81.25601.0025

Bosch
1 197 311 558

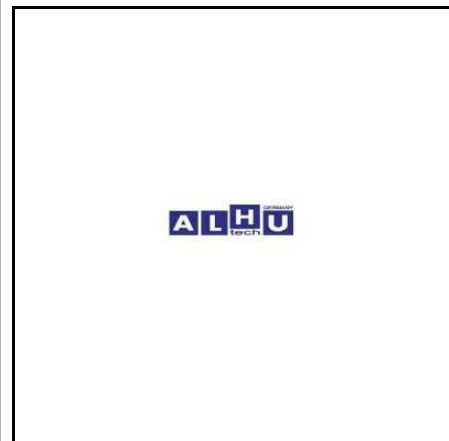

Getriebe / Gear

21 140 144	BALL JOINT
TGA TGS TGX	
<p>MAN 81.95301.6144</p>	



21 250 043	BALL JOINT
<p>MAN 81.95302.0044</p>	



22 268 189	BALL JOINT
LEFT	
<p>MAN 81.95301.6171</p>	<p>Scania 371451</p>
<p>Mercedes Benz 000 268 61 89</p>	<p>ZF 0732 107 019</p>



22 268 289	BALL JOINT
RIGHT	
<p>MAN 81.95301.6170</p>	<p>Scania 371452</p>
<p>Mercedes Benz 000 268 62 89</p>	<p>ZF 0732 107 018</p>



Getriebe / Gear

22 268 589 BALL JOINT
TOP, W. NUT

MAN
81.95301.6169

ZF
0501 203 819
0501 204 714

Mercedes Benz
000 268 48 89
000 268 52 89



21 255 002 BEARING BRACKET

MAN
81.32404.0002

ZF
1315 306 080



22 260 121 BELLOW

MAN
81.96420.0142



25 580 007 BLEEDER VALVE

TGA

MAN
81.32580.0007

ZF
0501 202 797

Mercedes Benz
000 260 03 58

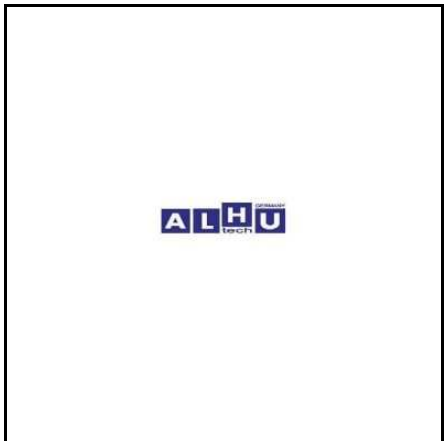

Getriebe / Gear

63 450 112 BUSH

MAN
81.93020.0525

ZF
0730 260 330

Mercedes Benz
000 268 21 50



63 450 163 BUSH

MAN
81.93020.0986



24 051 111 CLUTCH BOOSTER

MAN
81.30725.6026

Wabco
970.051.111.0

KNORR
I93581



24 051 157 CLUTCH BOOSTER

F 2000

MAN
81.30725.6053

Wabco
970.051.157.0



Getriebe / Gear

24 051 176 CLUTCH BOOSTER

MAN
N1.01101.0080

Wabco
970.051.176.0

KÄSSBOHRER
89199177844



24 051 307 CLUTCH BOOSTER

F 2000

MAN
81.30725.6065

KNORR
II31733
628027AM



24 051 406 CLUTCH BOOSTER

L 2000 M 2000

MAN
81.30725.6069

Wabco
970.051.406.0



24 051 412 CLUTCH BOOSTER

TGA TGS TGX

MAN
81.30725.6084

Wabco
970.051.412.0

KNORR
630361AM



Getriebe / Gear

24 051 441 CLUTCH BOOSTER

MAN
81.30725.6104

Wabco
970.051.441.0

Mercedes Benz
000 254 04 47



63 450 810 CLUTCH BOOSTER

 **MAN**
81.32735.6047

Wabco
470.051.114.0

Mercedes Benz
001 295 47 06



24 051 905 CLUTCH BOOSTER KIT

MAN
81.30725.6040

Wabco
970.051.905.2



21 290 113 CLUTCH CYLINDER REPAIR KIT

MAN
81.30715.6113

TA501
RK23722



Getriebe / Gear

21 290 118 CLUTCH CYLINDER REPAIR KIT

MAN
81.30715.6118

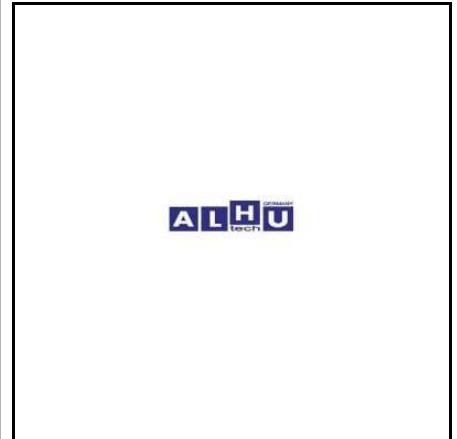

63 451 665 CLUTCH FORK



MAN
81.30530.0037

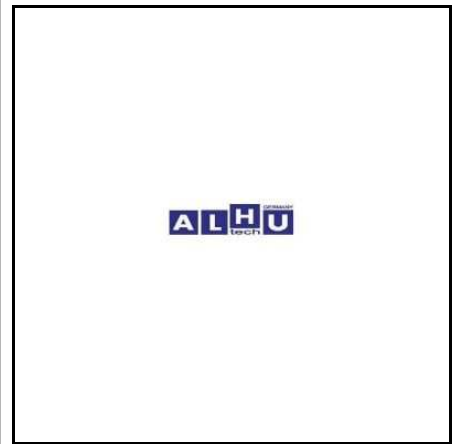

21 250 019 CLUTCH FORK REPAIR KIT

MAN
81.30560.6019



21 203 012 CLUTCH HOSE

MAN
06.54100.4370

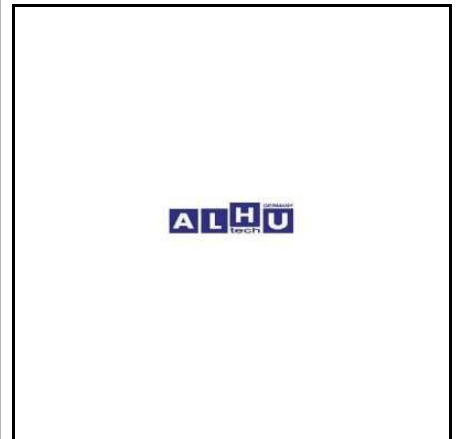

Getriebe / Gear

21 250 115 CLUTCH MASTER CYLINDER

MAN
81.30715.6115

FTE
KG 23712.1.4



21 290 011 CLUTCH MASTER CYLINDER

MAN
81.30715.6040



21 290 051 CLUTCH MASTER CYLINDER

MAN
81.30715.6051



21 290 116 CLUTCH MASTER CYLINDER

MAN
81.30715.6116

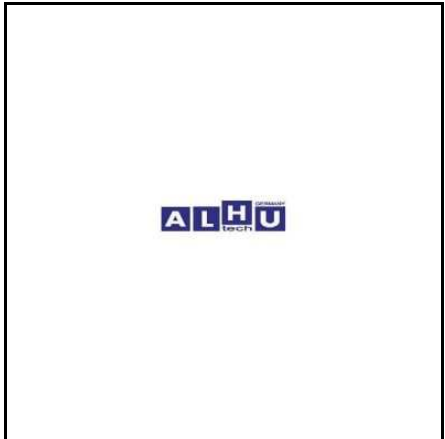

Getriebe / Gear

21 290 119 CLUTCH MASTER CYLINDER

MAN
81.30715.6119



21 290 120 CLUTCH MASTER CYLINDER

F 2000

MAN
81.30715.6120



21 290 135 CLUTCH MASTER CYLINDER

F 2000

MAN
81.30715.6135



63 450 672 CLUTCH MASTER CYLINDER

MAN
81.30715.6117

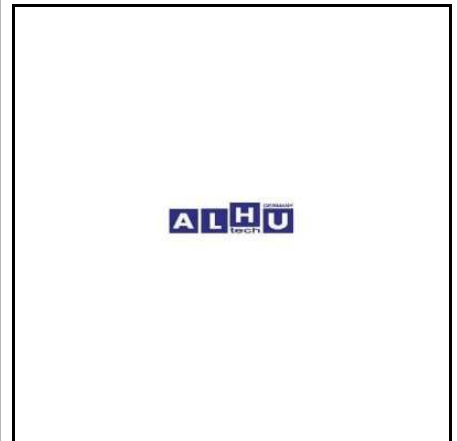

Getriebe / Gear

21 250 050 CLUTCH OPERATING LEVER

MAN
81.30560.0050

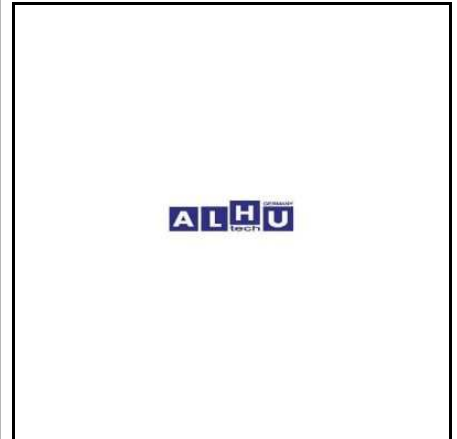

21 255 055 CLUTCH PIVOT

MAN
81.30560.0055



21 250 002 CLUTCH RELEASE BEARING

MAN
81.30550.0117

Mercedes Benz
002 250 49 15
003 250 14 15



21 250 082 CLUTCH RELEASE BEARING

TGL TGM

MAN
81.30550.0082

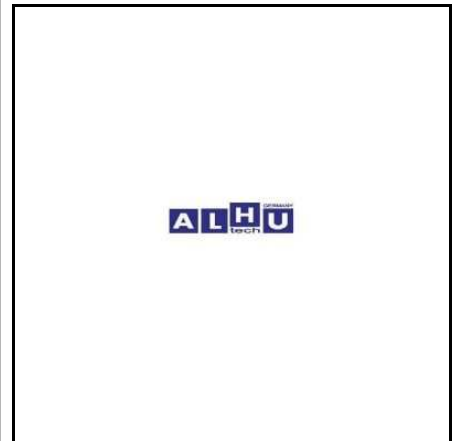

Getriebe / Gear

21 250 085 CLUTCH RELEASE BEARING

MAN
81.30550.0085

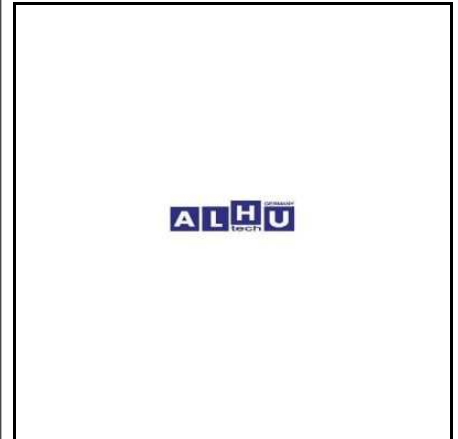

21 250 105 CLUTCH RELEASE BEARING

MAN
81.30550.0105

Mercedes Benz
002 250 51 15

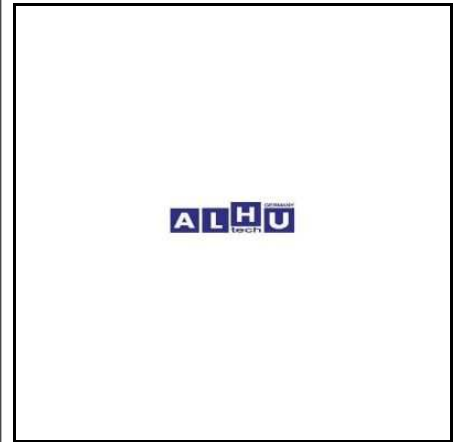

21 250 109 CLUTCH RELEASE BEARING

MAN
81.30550.0116



21 250 110 CLUTCH RELEASE BEARING

MAN
81.30550.0110

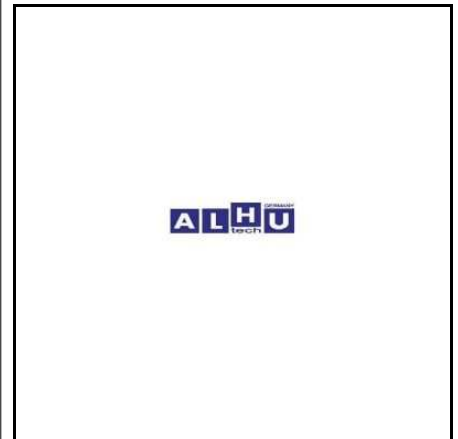

Getriebe / Gear

63 450 668 CLUTCH RELEASE BEARING

MAN
81.30550.0050

**63 450 669 CLUTCH RELEASE BEARING**

MAN
81.30550.0056

**63 450 670 CLUTCH RELEASE BEARING**

MAN
81.30550.0251

**21 250 007 CLUTCH RELEASE LEVER**

for ZF gearbox

MAN
81.32411.0007

ZF
1315 268 017



Getriebe / Gear

21 250 063 CLUTCH RELEASE LEVER
for EATON gearbox

MAN
81.30560.0063



25 250 001 CLUTCH RELEASE LEVER

MAN
81.30560.0061

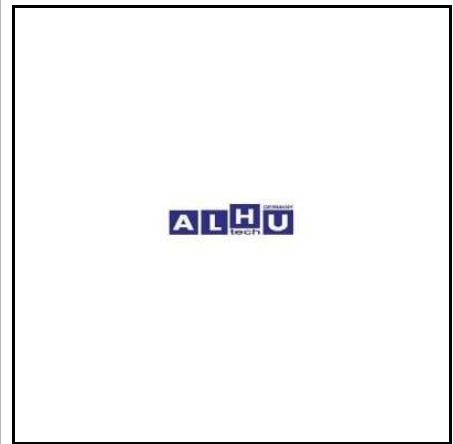

21 252 646 CLUTCH REPAIR KIT

MAN 81.30300.6002 81.30300.6003	Mercedes Benz 000 252 06 46
DAF 1328793	Iveco 93161755

weitere/another



25 250 010 CLUTCH REPAIR KIT

MAN
81.30300.6004

Mercedes Benz
000 252 03 46

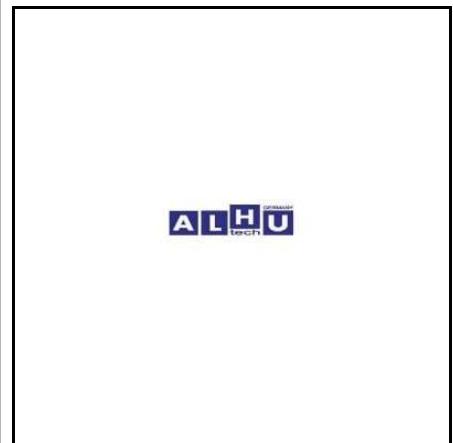

Getriebe / Gear

63 450 674 CLUTCH SLAVE CYLINDER

MAN
81.30716.6044



63 450 675 CLUTCH SLAVE CYLINDER

MAN
81.30716.6057

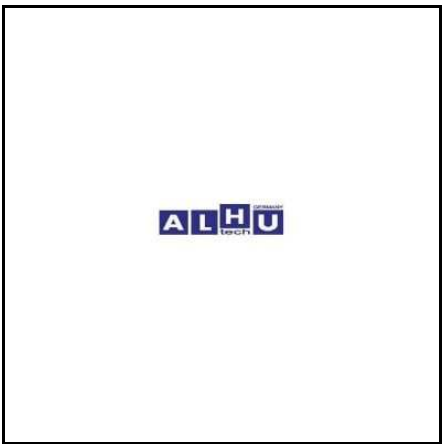

63 450 677 CLUTCH SLAVE CYLINDER

MAN
81.30716.6082

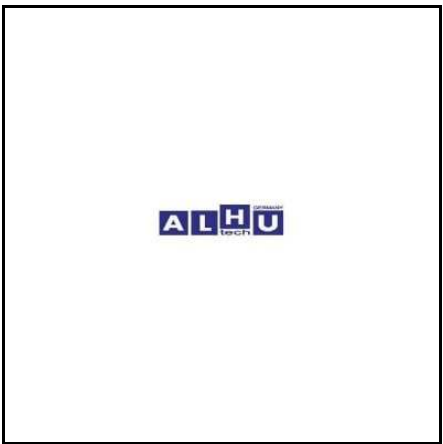

22 260 010 COVER, GEARSHIFT

F 2000

MAN
81.97010.0210

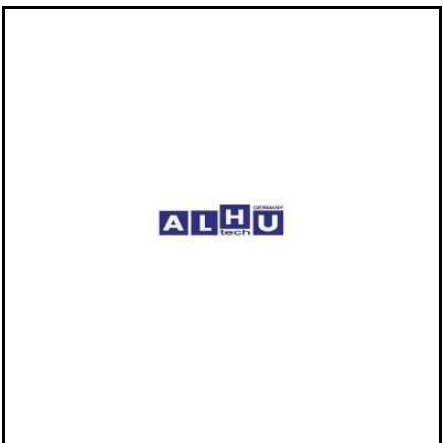

Getriebe / Gear

63 450 728 COVER, GEARSHIFT

MAN
81.97010.0211



22 260 017 CUT-OFF VALVE

MAN
81.52131.6017

ZF
6038 202 043



22 713 014 DAMPING WASHER

MAN
81.90713.0014



22 713 015 DAMPING WASHER

TGA

MAN
81.90713.0015



Getriebe / Gear

21 527 022 DOUBLE GROOVED RING

MAN
81.32527.0022

ZF
0750 112 177

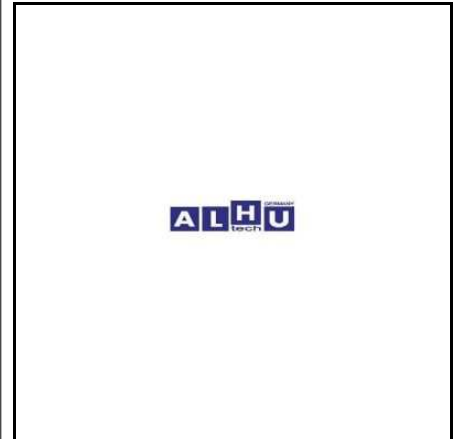

22 260 324 GEAR LEVER BOOT

F 2000

MAN
81.96420.0324



22 268 089 GEARBOX MOUNTING

MAN
81.96210.0089



21 470 046 GEARBOX OIL FILTER

MAN
81.33901.6046

TA501
59.3355.10

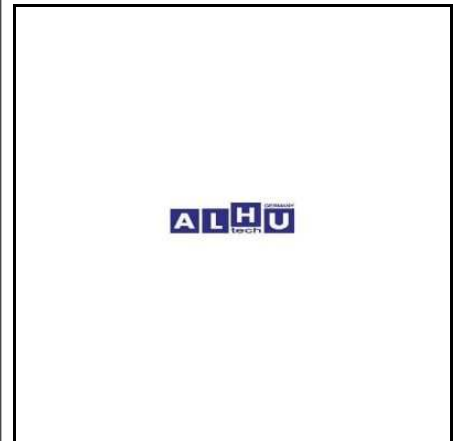

Getriebe / Gear

63 450 679 GEARSHIFT LEVER COVER
black

MAN
81.32620.0101



63 450 680 GEARSHIFT LEVER COVER
grey

MAN
81.32620.0102



63 450 681 GEARSHIFT LEVER HANDLE

MAN
81.32620.0106



25 670 199 GEARSHIFT LEVER REPAIR KIT

MAN
81.32670.6199



Getriebe / Gear

63 450 086 GUIDE RING	
MAN 81.91710.0357	Iveco 08190758
Mercedes Benz 000 267 10 59	ZF 0750 112 066



21 470 006 HYDRAULIC OIL FILTER	
MAN 81.06668.0006	
Mann + Hummel H 824/2 X	



22 260 007 INSULATING ELEMENT	
	F 2000
MAN 81.32616.0007	



22 260 008 INSULATING ELEMENT	
	L 2000 M 2000
MAN 81.32616.0013	



Getriebe / Gear

63 450 678 INSULATING ELEMENT

MAN
81.32616.0011

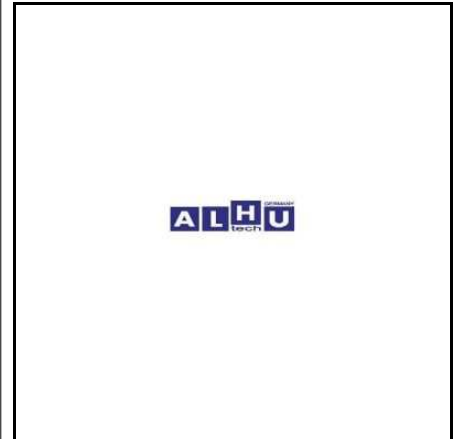

63 450 111 LATCH STOP

MAN
81.32545.0033

ZF
1315 207 014

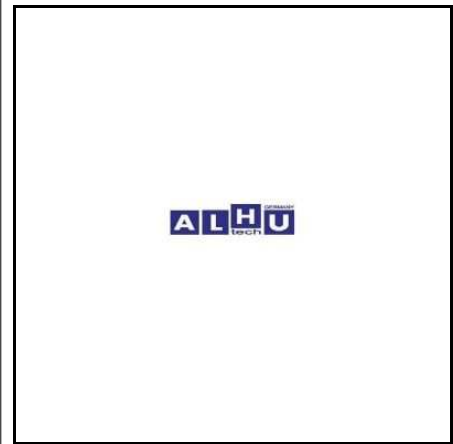

22 550 012 MAGNETIC VALVE

MAN
81.32550.0012

ZF
0501 321 458

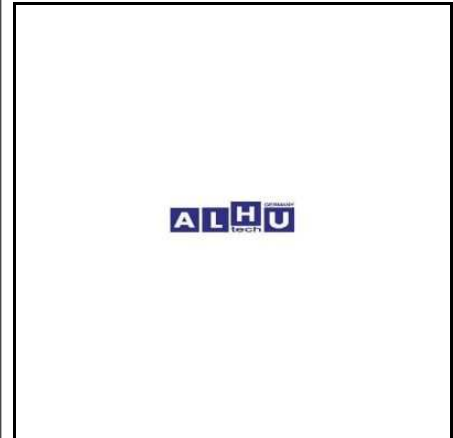

22 260 157 MULTIWAY VALVE

MAN
85.32734.6001

Iveco
42634677

DAF
1374723

ZF
0501 208 629



Getriebe / Gear

22 260 457 MULTIWAY VALVE

MAN
81.32734.6001

Wabco
571.003.104.0

Mercedes Benz
000 260 14 57



23 351 006 OIL SEAL

MAN
81.41351.0006

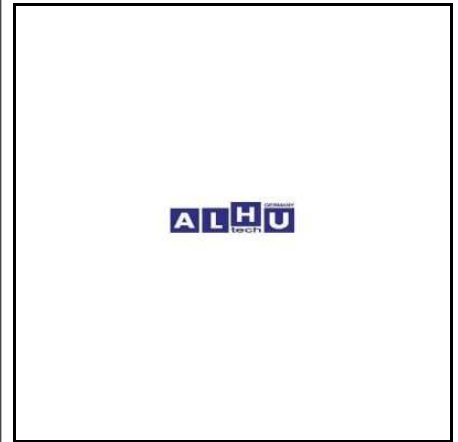

63 451 664 RELEASE LEVER



MAN
81.30560.0078

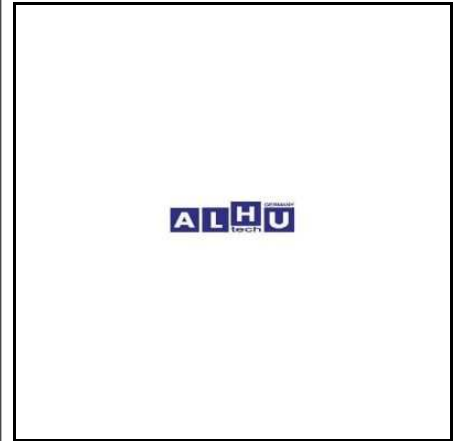

63 450 671 REPAIR KIT
for clutch master cylinder

MAN
81.30715.6104

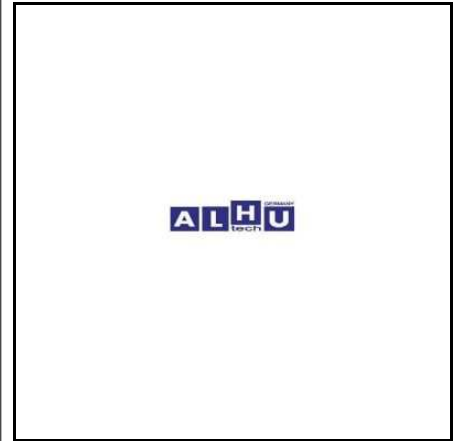

Getriebe / Gear

63 450 673 REPAIR KIT
for clutch master cylinder

MAN
81.30715.6126



63 450 676 REPAIR KIT
for clutch slave cylinder

MAN
81.30716.6071



63 451 336 REPAIR KIT

MAN
81.32670.6259



63 450 684 REPAIR KIT GEAR SHIFT COVER

MAN
81.32655.6180



Getriebe / Gear

25 655 157 REPAIR KIT, SHIFT MECHANISM

TGA TGS TGX

MAN
81.32655.6157



22 240 388 RUBBER MOUNTING

MAN
81.96210.0388



22 260 267 RUBBER MOUNTING

MAN
81.96210.0267



22 655 182 SHIFT CYLINDER

TGA

MAN
81.32655.6115
81.32655.6182

ZF
0501 213 654

TA501
629219



Getriebe / Gear

22 260 001 SHIFT KNOB

F 2000

MAN
81.97010.6010



22 260 002 SHIFT KNOB

F 90

MAN
81.97010.6012

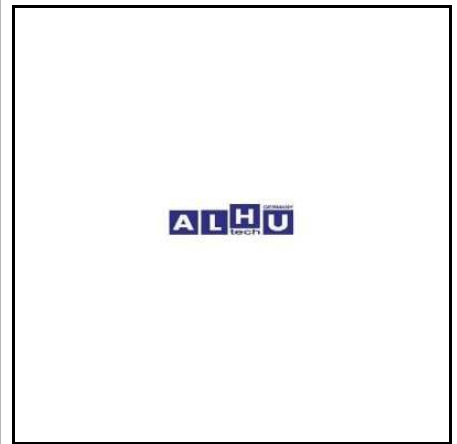

22 260 003 SHIFT KNOB

TGA TGS TGX

MAN
81.32620.0049

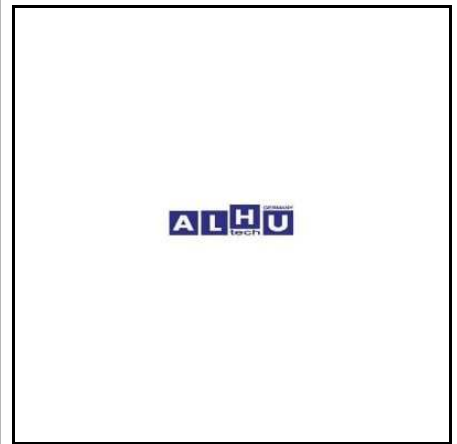

22 260 004 SHIFT KNOB

TGA TGS TGX

MAN
81.32620.0043

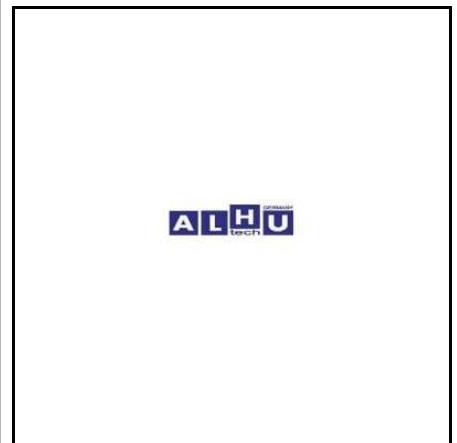

Getriebe / Gear

22 260 005 SHIFT KNOB

TGA

MAN
81.32620.0044



22 260 006 SHIFT KNOB

TGA TGS TGX

MAN
81.32620.0046



22 260 011 SHIFT KNOB

F 2000

MAN
81.97010.6011



22 260 012 SHIFT KNOB

MAN
81.97010.6007

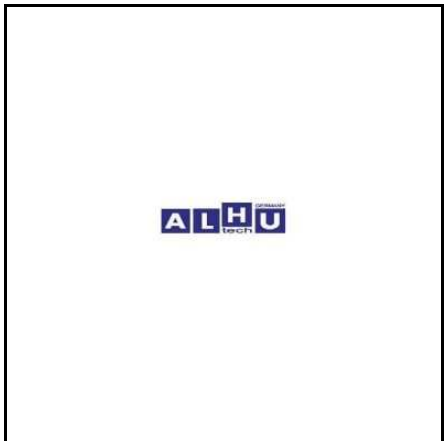

Getriebe / Gear

22 260 013 SHIFT KNOB

MAN
81.97010.6013



22 260 014 SHIFT KNOB

TGA TGS TGX

MAN
81.32620.0050

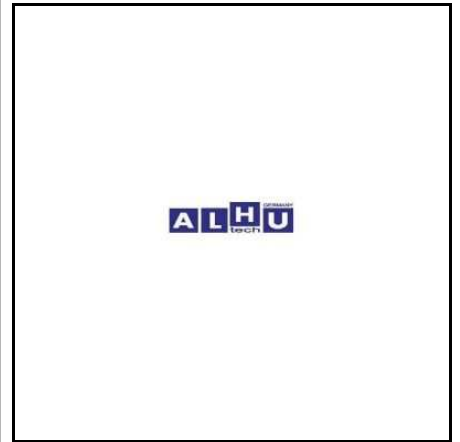

22 260 021 SHIFT KNOB

MAN
81.97010.6021

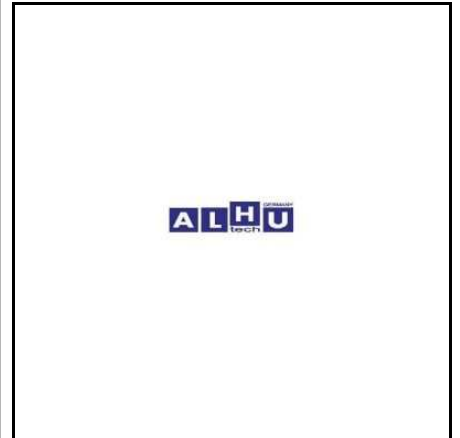

22 260 045 SHIFT KNOB

TGA TGS TGX

MAN
81.32620.0045

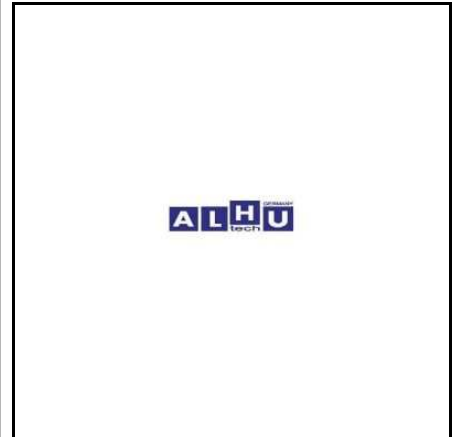

Getriebe / Gear

63 450 838 SHIFT KNOB

MAN
81.97010.6001

ZF
6038 323 060

Mercedes Benz
000 268 05 42

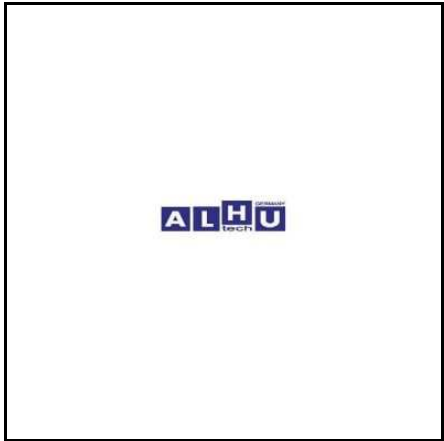

63 451 510 SHIFT KNOB



MAN
81.32620.0091



25 605 111 SHIFT MECHANISM

TGA TGX

MAN
81.32605.6111

TA501
627496AM



63 451 137 SHIFT MECHANISM

MAN
81.32655.6181

TA501
629218AM

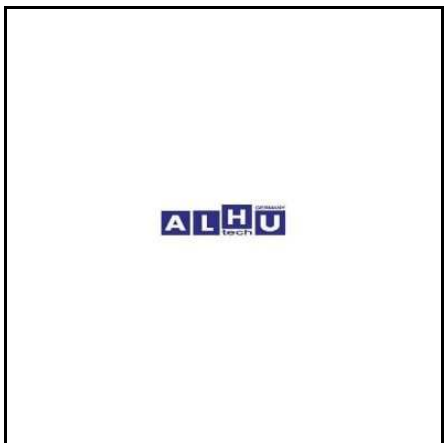

Getriebe / Gear

22 422 010 SHIFTING CYLINDER	
MAN 81.32735.6040	Wabco 422.010.010.0
Mercedes Benz 000 260 47 63	ZF 0750 132 009



22 422 012 SHIFTING CYLINDER	
MAN 81.32735.6041	Wabco 422.010.012.0
Mercedes Benz 000 260 46 63	ZF 0750 132 019



22 260 059 SHIFTING VALVE	
MAN 81.52170.6127	
ZF 0501 310 059	

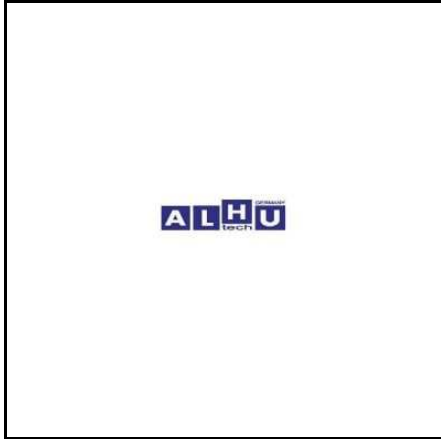

22 260 357 SHIFTING VALVE	
MAN 81.32550.0003	
Mercedes Benz 001 260 63 57	

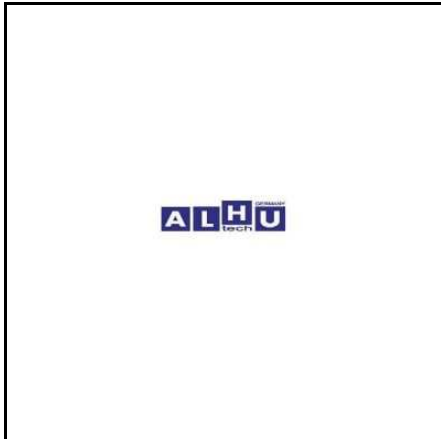

Getriebe / Gear

22 260 857 SHIFTING VALVE	
MAN 81.32734.6027	KNORR SV 3302
Mercedes Benz 001 260 27 57	



25 260 003 SHIFTING VALVE	
MAN 81.32734.6015	KNORR SV 3360
Mercedes Benz 001 260 02 57	ZF 0750 132 008



616710 SLIDING BLOCK	
MAN 81.32526.0031	ZF 1297 306 120
Mercedes Benz 000 268 11 49	



22 260 757 SPLITTER VALVE	
MAN 81.52170.6128	KNORR I76936 SV 3368
Mercedes Benz 001 260 67 57	ZF 6038 202 003



Getriebe / Gear

616709 THRUST PIECE

MAN 81.32510.0013	ZF 1297 304 436
Mercedes Benz 000 264 08 39	



25 820 520 WIRE RING

MAN
81.90820.0520



22 036 000 3/2 DIRECTIONAL CONTROL VALVE

MAN 81.52185.6023	KNORR 166920
Mercedes Benz 001 997 61 36	



25 131 015 5/2 WAY VALVE

MAN 81.52131.6015	Iveco 42535033
DAF 1374724	ZF 0501 215 359

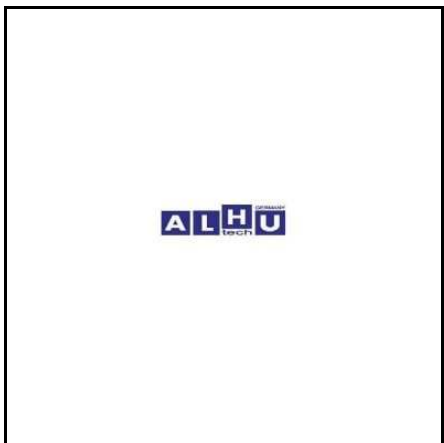

Kabine / Cabin

28 880 074 AIR DAM 190 MM

MAN
81.41613.0074



28 880 073 AIR DAM 250 MM

F 2000

MAN
81.41613.0073



28 880 071 AIR DAM 350 MM

F 2000

MAN
81.41613.0071



28 880 077 AIRDAM END PANEL LEFT

MAN
81.41613.0077

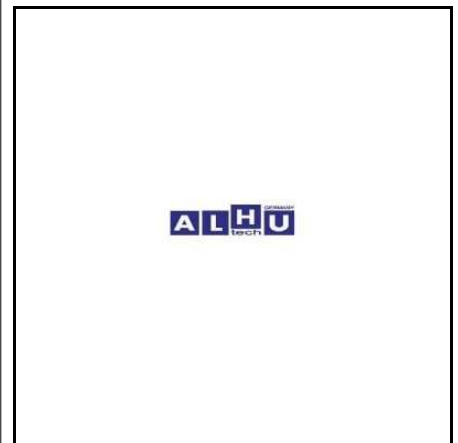

Kabine / Cabin

28 880 076 AIRDAM END PANEL RIGHT

MAN
81.41613.0076



28 880 078 AIRDAM END PANEL RIGHT

F 2000

MAN
81.41613.0078

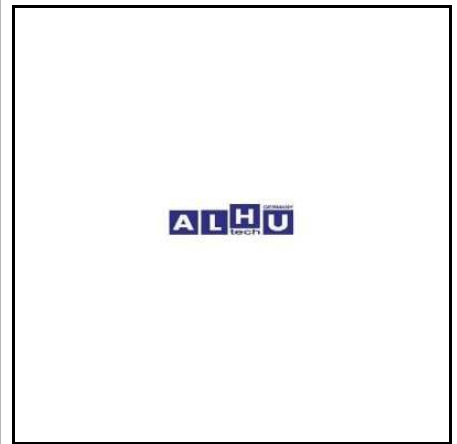

28 880 079 AIRDAM END PANEL, LEFT

F 2000

MAN
81.41613.0079

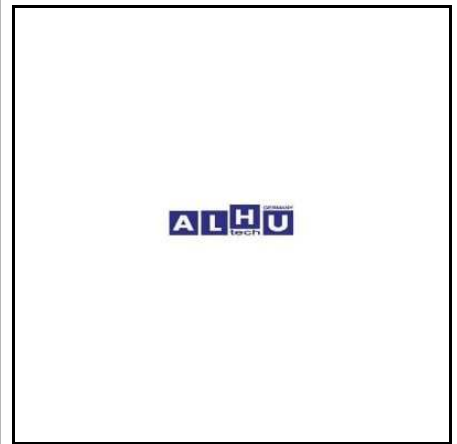

28 880 081 AIRDAM END PANEL, LEFT

F 2000

MAN
81.41613.0081

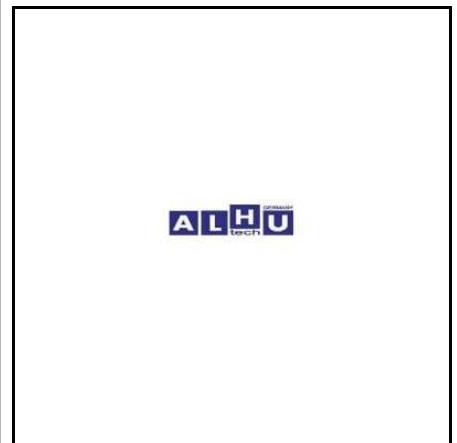

Kabine / Cabin

28 880 080 AIRDAM END PANEL, RIGHT

MAN
81.41613.0080

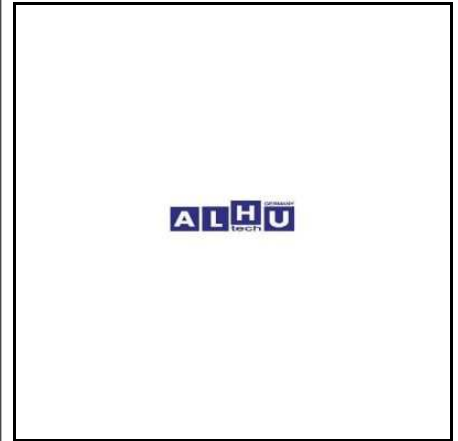

28 880 035 AIRDAM MOUNTING

F 2000

MAN
81.41613.5035



21 541 058 BATTERY COVER

F 2000

MAN
81.41860.0058



21 541 090 BATTERY COVER

TGA

MAN
81.41860.6090

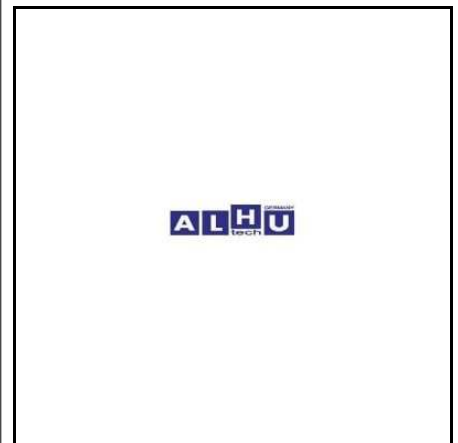

Kabine / Cabin

28 500 210 BEARING BUSH

MAN
06.36950.0210



28 826 089 BLINKER LAMP
E-mark yes
TGA

MAN
81.25320.6089

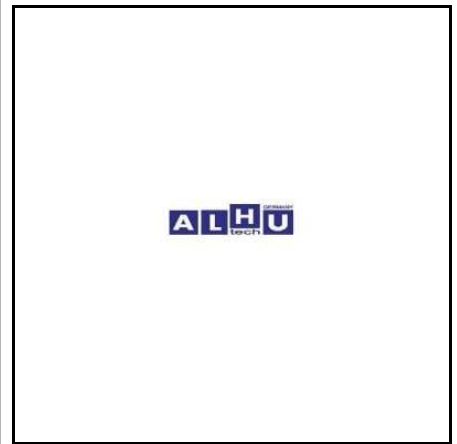

28 826 090 BLINKER LAMP
E-mark yes
TGA

MAN
81.25320.6090

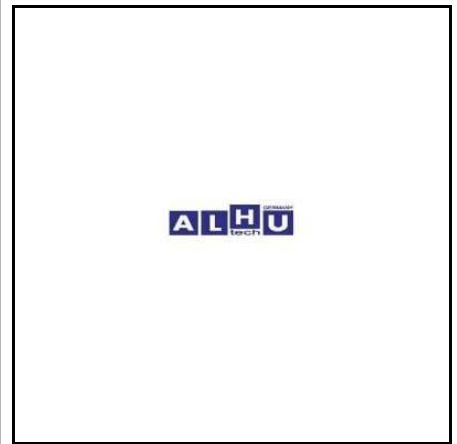

28 826 111 BLINKER LAMP
E-mark yes
TGA

MAN
81.25320.6091
81.25320.6111



Kabine / Cabin

28 826 112	BLINKER LAMP
E-mark yes	TGA
MAN 81.25320.6092 81.25320.6112	

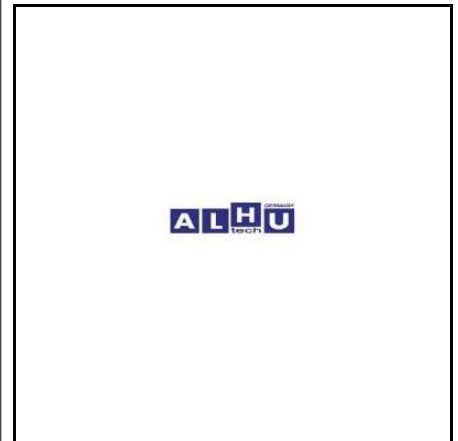

28 826 113	BLINKER LAMP
E-mark yes	TGA
MAN 81.25320.6113	

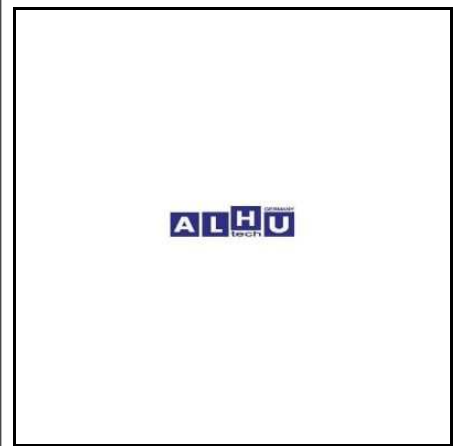

28 826 114	BLINKER LAMP
E-mark yes	TGA
MAN 81.25320.6114	

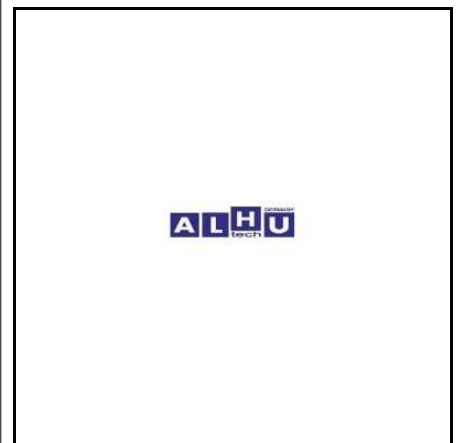

28 826 117	BLINKER LAMP
yellow	TGA
MAN 81.25320.6117	

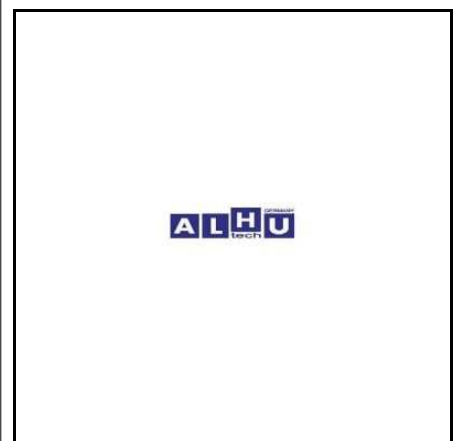

Kabine / Cabin

28 826 118	BLINKER LAMP
E-mark yes	TGX
MAN 81.25320.6118	

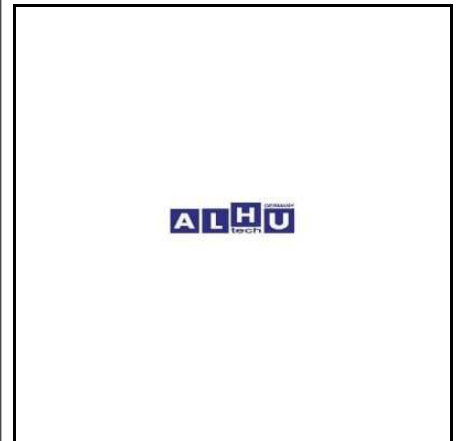

63 450 099	BLINKER LAMP
E-mark yes	F 2000
MAN 81.25260.6039	

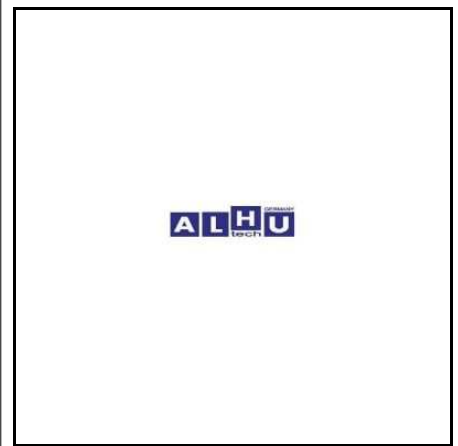

63 450 110	BLINKER LAMP
E-mark yes	TGA
MAN 81.25320.6088	

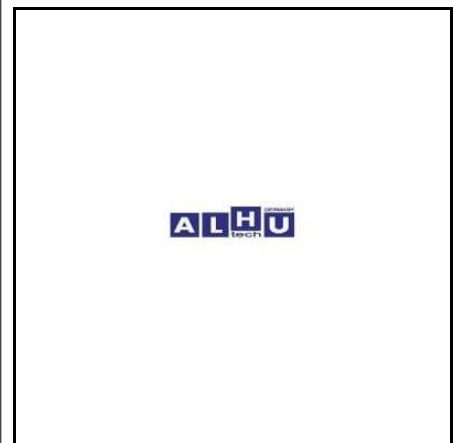

63 450 665	BLINKER LAMP
MAN 81.25320.6043	

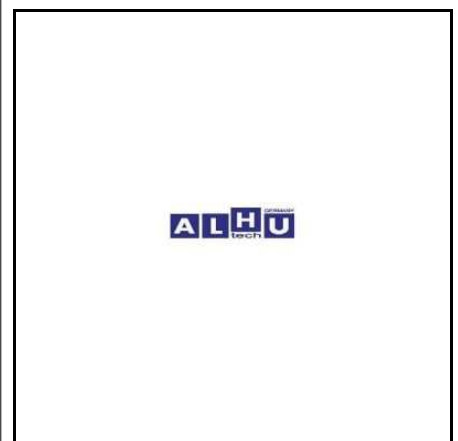

Kabine / Cabin

28 830 003 BLOWER MOTOR

MAN
81.61930.6098



28 830 108 BLOWER MOTOR

F 2000

MAN
81.61930.0055

Mercedes Benz
001 830 03 08

Bosch
0 130 111 130



28 830 204 BLOWER MOTOR

Bosch
0 130 111 204



28 830 208 BLOWER MOTOR

L 2000 M 2000

MAN
81.61930.0042

Mercedes Benz
001 830 02 08

Bosch
0 130 111 116

Volvo
8157216



Kabine / Cabin

28 830 308 BLOWER MOTOR

MAN
81.61930.0036

Mercedes Benz
000 830 93 08

Bosch
0 130 063 029



28 831 108 BLOWER MOTOR

F 2000

MAN
81.28601.6011

Bosch
0 130 007 004



63 450 205 BLOWER MOTOR

MAN
81.77930.6034
81.77930.6050



26 680 132 BOWDEN CABLE

MAN
81.62680.0132



Kabine / Cabin

63 450 682	BOWDEN CABLE
	9600MM
MAN	
81.32655.6072	

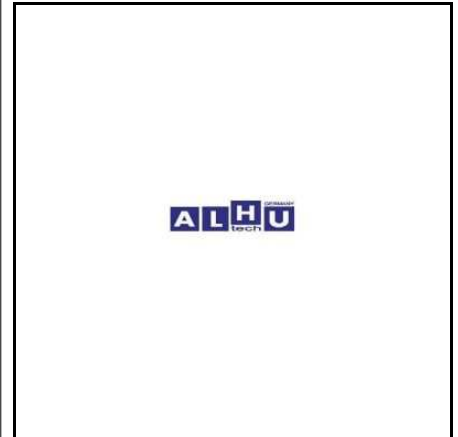

63 450 683	BOWDEN CABLE
	9260MM
MAN	
81.32655.6074	

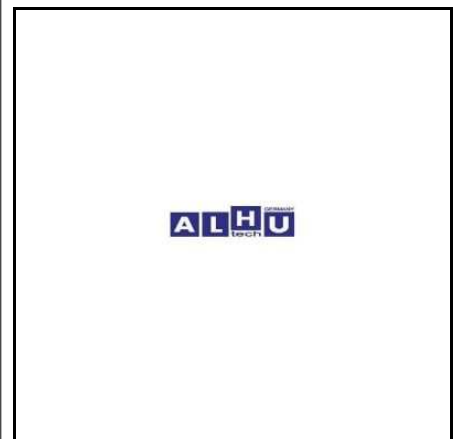

63 450 717	BOWDEN CABLE
	9390MM
MAN	
81.95501.6270	

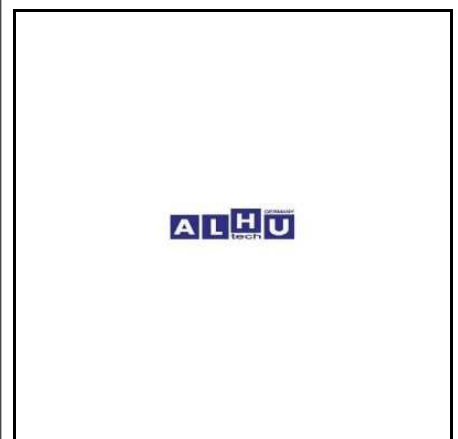

63 450 718	BOWDEN CABLE
	1990MM
MAN	
81.95501.6452	

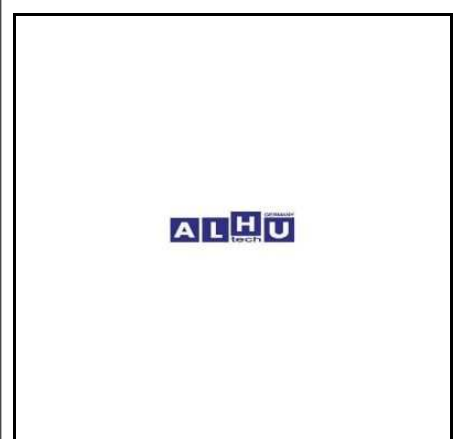

Kabine / Cabin

63 450 719 BOWDEN CABLE

MAN
81.95501.6457



63 450 720 BOWDEN CABLE

MAN
81.95501.6460



63 450 721 BOWDEN CABLE
2285MM

MAN
81.95501.6477



63 451 402 BOWDEN CABLE

 **MAN**
81.32655.6249



Kabine / Cabin

26 420 125	BRACKET
mudguard support	
MAN	
81.66420.0125	

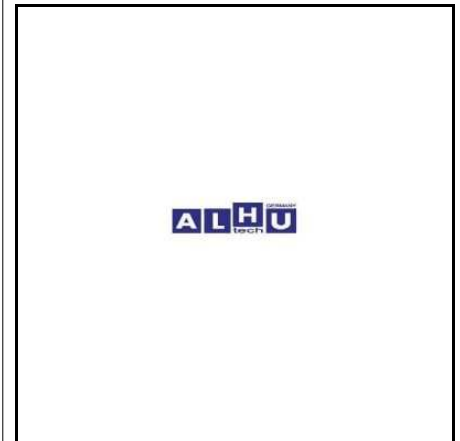

26 640 114	BRACKET
MAN	
81.43640.5114	

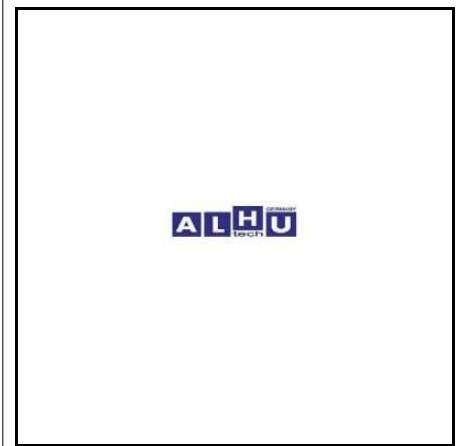

63 450 661	BRACKET
MAN	
81.25140.0121	

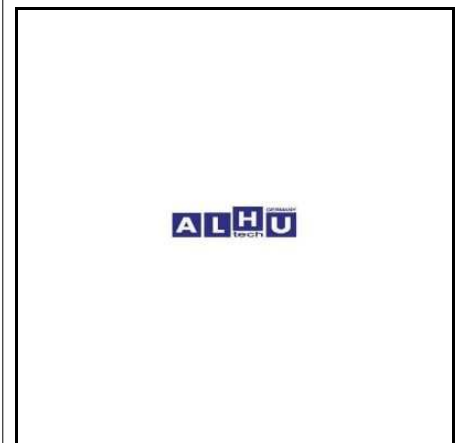

63 450 664	BRACKET
MAN	
81.25245.0144	

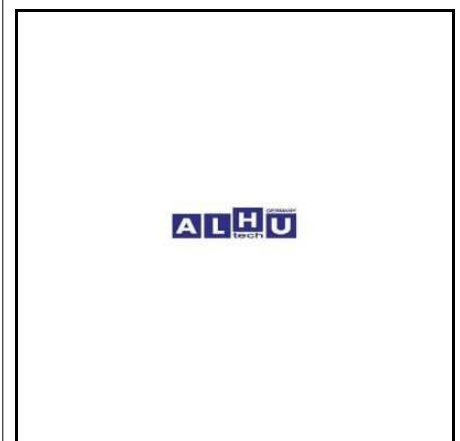

Kabine / Cabin

28 417 091 BRACKET LEFT

MAN
81.41720.0091



26 610 307 BUMPER

TGA TGS

MAN
81.41610.0307



26 610 308 BUMPER

MAN
81.41610.0308



26 660 000 BUMPER

MAN
81.41610.0361



Kabine / Cabin

26 660 001 BUMPER

MAN
81.41610.0364



28 880 114 BUMPER

F 2000

MAN
81.41610.4114



28 880 305 BUMPER

TGA TGX

MAN
81.41610.0305



28 880 306 BUMPER

TGA TGS TGX

MAN
81.41610.0306

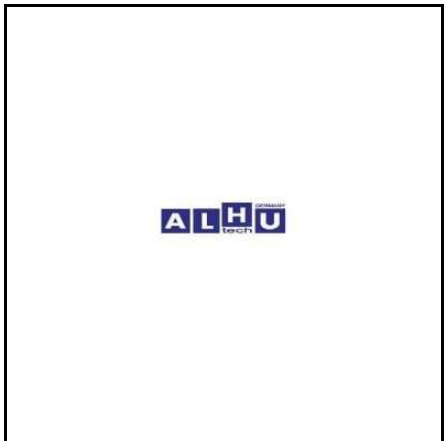

Kabine / Cabin

26 660 004 BUMPER CORNER

MAN
81.41614.0023

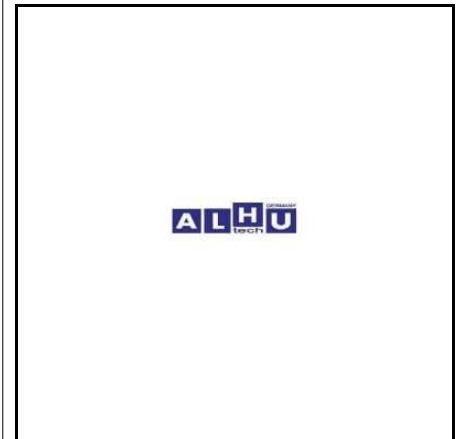

26 660 005 BUMPER CORNER

MAN
81.41614.0024

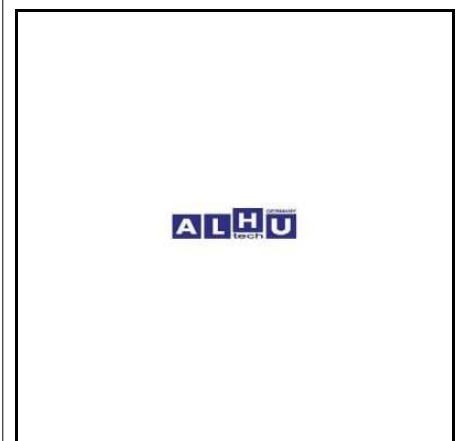

63 450 722 BUMPER COVER

MAN
81.96002.0328

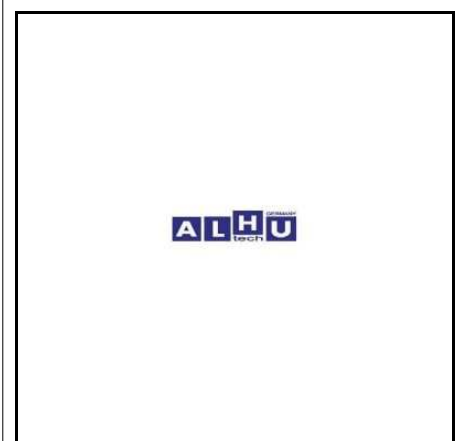

63 450 723 BUMPER COVER

MAN
81.96002.0491

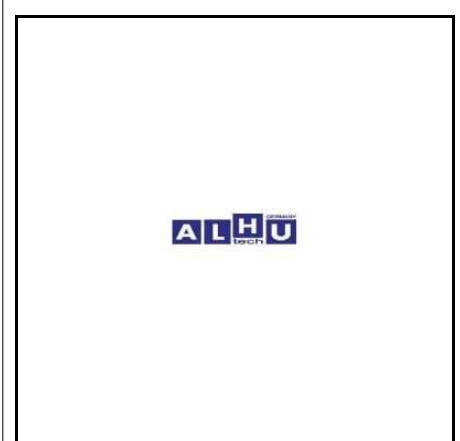

Kabine / Cabin

63 453 025 BUMPER COVER



MAN
81.41685.0029



26 610 231 BUMPER END PANEL

TGA

MAN
81.41610.0231



26 610 232 BUMPER END PANEL

TGA

MAN
81.41610.0232



26 660 002 BUMPER END PANEL

MAN
81.41610.0369



Kabine / Cabin

26 660 003 BUMPER END PANEL

MAN
81.41610.0370

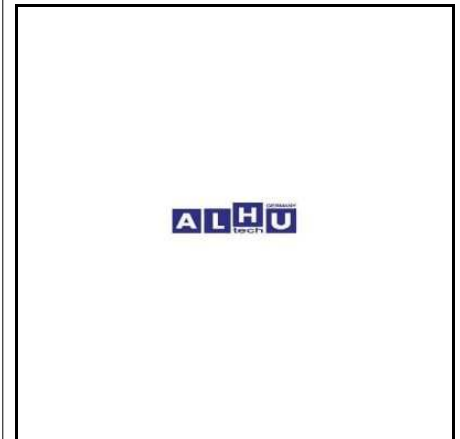

28 880 151 BUMPER END PANEL
left

F 2000

MAN
81.41610.0151

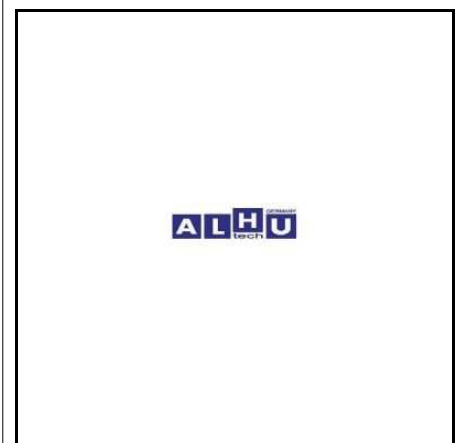

28 880 152 BUMPER END PANEL
right

F 2000

MAN
81.41610.0152

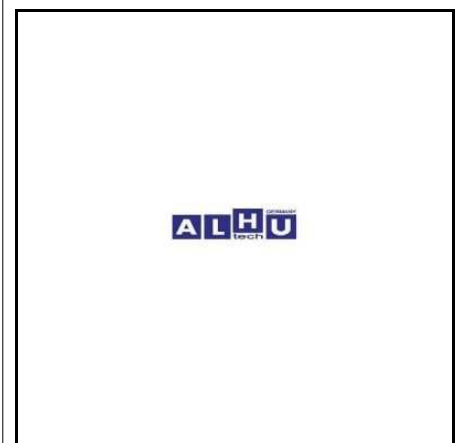

26 416 229 BUMPER PANEL

MAN
81.41610.0229

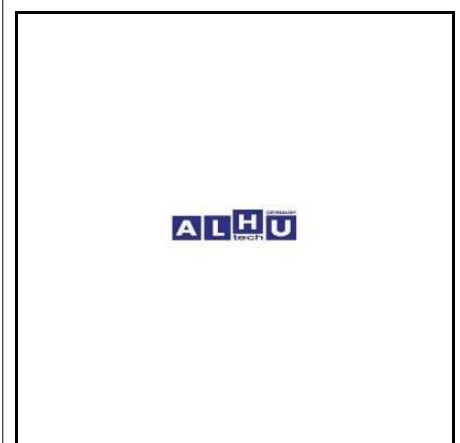

Kabine / Cabin

26 416 230 BUMPER PANEL

MAN
81.41610.0230

**28 723 046 BUSH**

MAN
81.62690.0046

**63 450 115 BUSH, CABIN TILT**

TGA

MAN
81.41723.0067

**28 500 638 CAB TILT OUTER WASHER**

MAN
81.96101.0638



Kabine / Cabin

28 553 005 CABIN CYLINDER

F 2000

MAN
81.41723.6099



28 553 105 CABIN CYLINDER

TGA TGS TGX

MAN
81.41723.6123



28 553 205 CABIN CYLINDER

TGA TGX

MAN
81.41723.6124



28 553 305 CABIN CYLINDER

F 90

MAN
81.41723.6076



Kabine / Cabin

63 453 008 CABIN DAMPER

new

MAN
85.41722.6017



28 618 003 CABIN LOCK

TGA TGS TGX

MAN
85.61851.6003



28 618 023 CABIN LOCK
without switch

F 2000 TGA

MAN
81.61851.6023



28 618 023B CABIN LOCK
with switch 25 545 814

F 2000 TGA

MAN
81.61851.6023



Kabine / Cabin

28 317 412 CABIN MOUNTING

MAN
81.96210.0437

ALHU tech
28 500 437



28 500 012 CABIN MOUNTING

MAN
85.96210.0012



28 500 019 CABIN MOUNTING

MAN
85.96210.0019



28 500 021 CABIN MOUNTING

MAN
85.96210.0021



Kabine / Cabin

28 500 909 CABIN MOUNTING

MAN
81.90713.0909

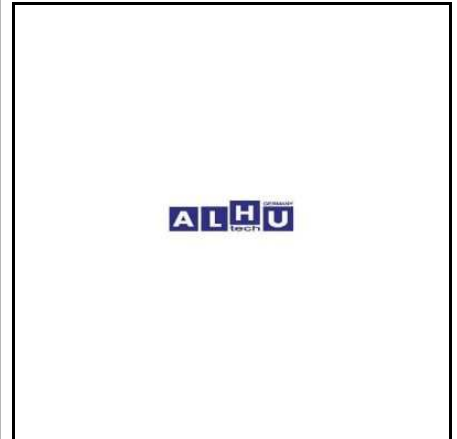

28 890 274 CABIN MOUNTING

MAN
81.96210.0274



28 890 400 CABIN MOUNTING

MAN
81.96210.0400

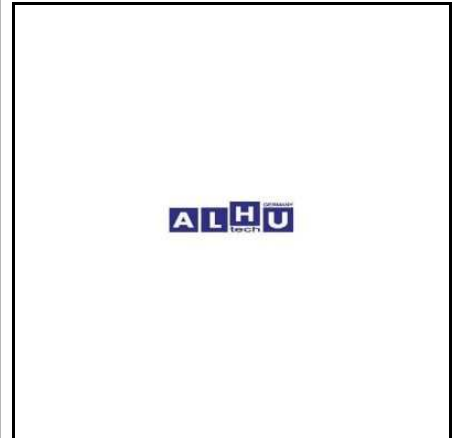

28 890 407 CABIN MOUNTING

MAN
81.96210.0407



Kabine / Cabin

28 890 462 CABIN MOUNTING

MAN
81.96210.0462

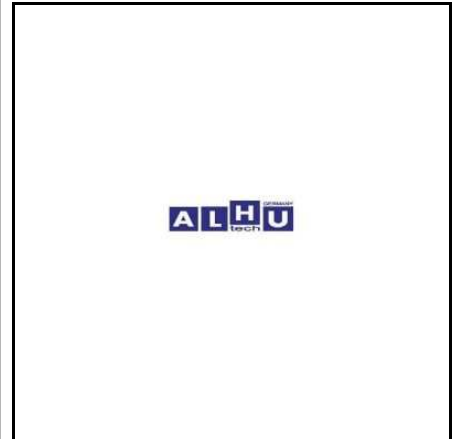

28 890 515 CABIN MOUNTING

MAN
81.96210.0515



28 890 536 CABIN MOUNTING

MAN
81.96210.0536



63 450 120 CABIN MOUNTING

TGA

MAN
85.96020.0004

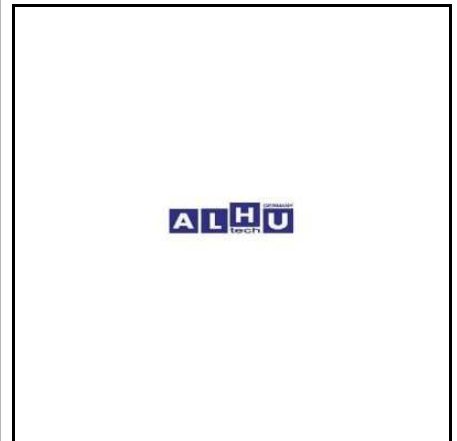

Kabine / Cabin

63 450 134 CABIN MOUNTING

MAN
85.96210.0030



28 500 437 CABIN MOUNTING KIT

MAN
81.96210.0437

ALHU tech
28 317 412



28 890 407S CABIN MOUNTING KIT

MAN
81.96210.0407



28 553 101 CABIN PUMP

F 2000

MAN
81.41723.6114



Kabine / Cabin

28 553 201 CABIN PUMP

TGA TGS TGX

MAN
 85.41723.6011
 85.41723.6020
 85.41723.6044



28 890 003 CABIN SHOCK ABSORBER

F 2000

MAN
 81.41722.6077
 85.41722.6022



28 890 004 CABIN SHOCK ABSORBER

F 2000

MAN
 81.41722.6058



28 890 005 CABIN SHOCK ABSORBER

F 2000

MAN
 81.41722.6057
 81.41722.6073



Kabine / Cabin

28 890 012 CABIN SHOCK ABSORBER

MAN
81.41722.6012



28 890 051 CABIN SHOCK ABSORBER FRONT

F 2000

MAN
81.41722.6051



28 890 052 CABIN SHOCK ABSORBER REAR

F 2000

MAN
81.41722.6052



28 891 013 CABIN SHOCK ABSORBER

MAN
81.41722.6013



Kabine / Cabin

63 450 023 CABIN SHOCK ABSORBER

MAN
81.41722.6050

**63 450 106 CABIN SHOCK ABSORBER**

MAN
85.41722.6023

**28 880 425 CAP, BUMPER**

MAN
81.96002.0425

**63 450 731 CLAMP LOCK**

MAN
81.97106.6015



Kabine / Cabin

63 450 211 CLEARANCE LAMP

MAN
81.25260.6074



63 450 212 CLEARANCE LAMP

MAN
81.25225.6485



63 451 130 CONNECTING LINK

MAN
81.26411.0093



63 451 131 CONNECTING LINK

MAN
81.26411.0094



Kabine / Cabin

63 451 132 CONNECTING LINK

MAN
81.26411.0095



28 880 022 CONTROL VALVE

MAN
81.61967.6022



26 624 046 CORNER COVER

MAN
81.62410.0046



26 624 047 CORNER COVER

MAN
81.62410.0047



Kabine / Cabin

26 624 091 CORNER COVER

MAN
81.62410.0091



26 624 092 CORNER COVER

MAN
81.62410.0092



26 610 226 CORNER COVER, RIGHT

TGA TGS

MAN
81.41610.0226



28 880 227 CORNER LEFT

TGA TGS TGX

MAN
81.41610.0227



Kabine / Cabin

28 880 228 CORNER RIGHT

TGA TGS TGX

MAN
81.41610.0228



63 450 724 CORRUGATED HOSE

MAN
81.96420.0156



28 880 158 COVER
right

MAN
81.41610.0158



28 880 159 COVER
left

MAN
81.41610.0159



Kabine / Cabin

63 450 280 COVER

MAN
81.91605.0041



63 450 101 COVER PLATE RAL9006

MAN
81.45950.0004



28 660 536 COVER STEPWELL

MAN
81.61510.0536



63 450 575 COVERING

MAN
85.41610.4013



Kabine / Cabin

28 670 011 DOOR ARRESTOR

F 2000

MAN
81.62670.6011



28 640 067 DOOR HANDLE
INNER, LEFT

TGA

MAN
81.62641.6067



28 640 068 DOOR HANDLE
INNER, RIGHT

MAN
81.62641.6068



28 641 085 DOOR HANDLE
left, complete

TGA TGS TGX

MAN
81.62641.6081
81.62641.6085



Kabine / Cabin

28 641 086	DOOR HANDLE
	right, complete
	TGA TGS TGX
MAN	
81.62641.6080	
81.62641.6086	



28 720 099	DOOR HANDLE
	LEFT
MAN	
81.62641.0099	



28 720 100	DOOR HANDLE
	RIGHT
MAN	
81.62641.0100	



28 971 099	DOOR HANDLE
	with lock and 2 keys
	F 2000
MAN	
81.97100.6099	



Kabine / Cabin

63 450 697	DOOR HANDLE
	inner
MAN	
81.62641.0001	

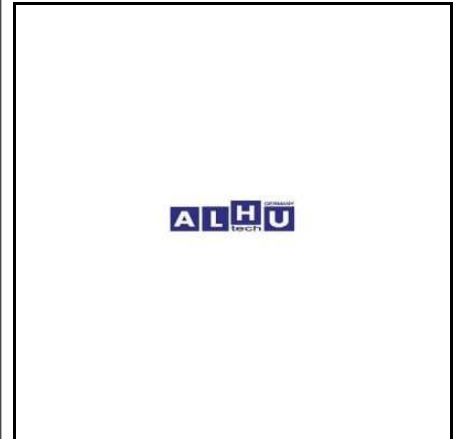

63 450 699	DOOR HANDLE
	right
MAN	
81.62641.0088	

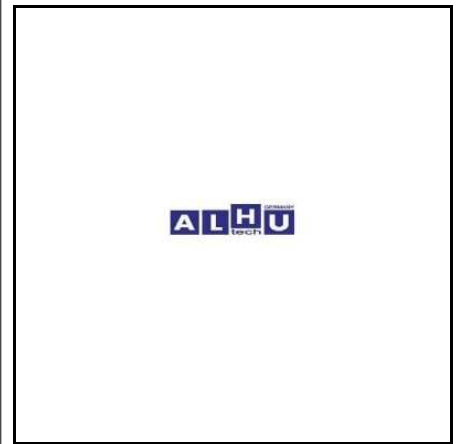

63 450 700	DOOR HANDLE
	left
MAN	
81.62641.0089	

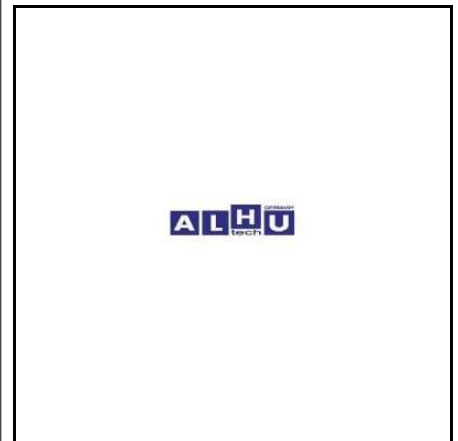

26 690 036	DOOR HINGE
	right
MAN	
81.62690.6036	

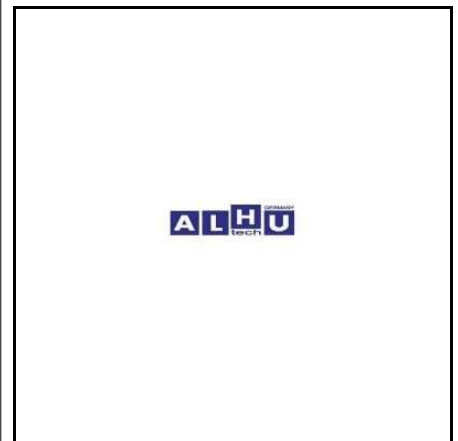

Kabine / Cabin

26 690 037	DOOR HINGE
	left
MAN	
81.62690.6037	



28 720 077	DOOR IN WHITE
	left
MAN	
81.62600.4087	



28 720 078	DOOR IN WHITE
	F 2000
MAN	
81.62600.4088	



28 626 095	DOOR LOCK
	LEFT
	F 2000
MAN	
81.62680.6095	



Kabine / Cabin

28 626 096	DOOR LOCK
	RIGHT
	F 2000
MAN	
81.62680.6096	



28 723 107	DOOR LOCK
	left
MAN	
81.62680.6107	

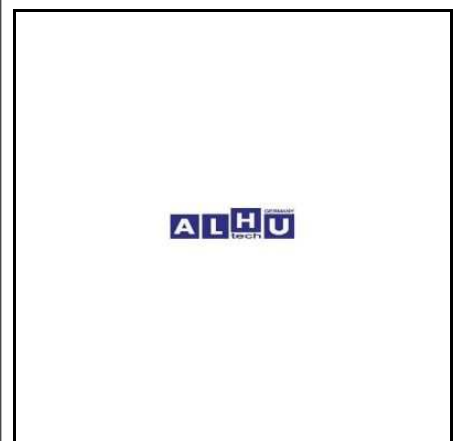

28 723 108	DOOR LOCK
	right
MAN	
81.62680.6108	

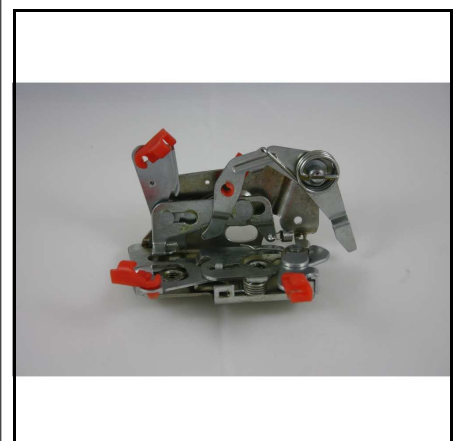

63 450 702	DOOR LOCK
	left
MAN	
81.62680.6065	

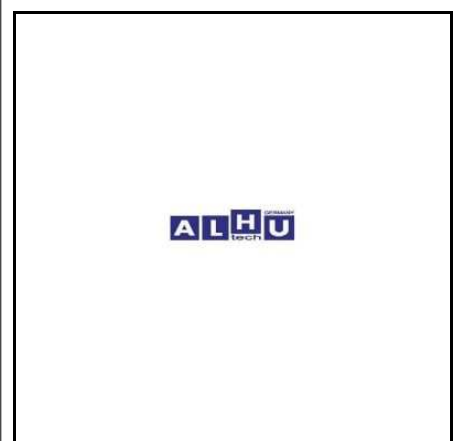

Kabine / Cabin

63 450 703 DOOR LOCK
right

MAN
81.62680.6066



63 451 138 DOOR LOCK

MAN
81.62680.6121



63 451 139 DOOR LOCK

MAN
81.62680.6122



28 720 021 DOOR PANELLING
left

MAN
81.62630.6021



Kabine / Cabin

28 720 020 DOOR PANNELING
right

MAN
81.62630.6020



63 450 136 ENGINE MOUNTING
right

MAN
81.96210.0406
81.96210.0604

LMI
2788901



63 450 733 ENGINE MOUNTING
left

MAN
81.96210.0605



28 880 020 EXPANSION VALVE

TGA TGS TGX

MAN
81.61967.0020



Kabine / Cabin

26 608 030 FAN SHROUD

MAN
51.06608.0030



26 662 158 FAN SHROUD

MAN
81.06620.0158



28 880 150 FLAP, LOWER

F 2000

MAN
81.41610.0150



28 880 191 FLAP, UPPER

MAN
81.41610.0191



Kabine / Cabin

25 260 005 **FLASHER LAMP**
 right, without E-mark

MAN
 81.25320.6078



63 450 097 **FLASHER LAMP**
 left

MAN
 81.25320.6095



63 450 100 **FLASHER LAMP**
 right

MAN
 81.25320.6096



63 450 207 **FLASHER LAMP**
 left, with E mark

MAN
 81.25225.6459

Mercedes Benz
 001 820 39 21



Kabine / Cabin

63 450 208 FLASHER LAMP

right, with E mark

MAN

81.25225.6460

Mercedes Benz

001 820 40 21

**28 820 085 FOG LAMP****MAN**

81.25102.6085

**63 450 232 FOG LAMP**

E-mark yes

TGX

MAN

81.25101.6521

**63 450 233 FOG LAMP**

E-mark yes

TGX

MAN

81.25101.6522



Kabine / Cabin

63 450 234	FOG LAMP LENS
E-mark yes	TGX
MAN 81.25110.0085	



63 450 235	FOG LAMP LENS
E-mark yes	TGX
MAN 81.25110.0086	



28 880 061	FOOTHOLD
MAN 81.41615.5061	



26 660 006	FRONT SERVICE DOOR
MAN 81.61110.6042	



Kabine / Cabin

28 888 053 FRONT SERVICE DOOR

MAN
81.61110.0053



28 888 043 FRONT SERVICE DOOR, WIDE

F 2000

MAN
81.61110.0043

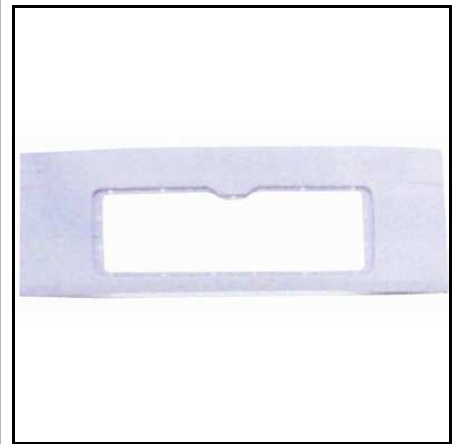

28 880 005 GAS SPRING

TGA TGS TGX

MAN
81.97006.0003

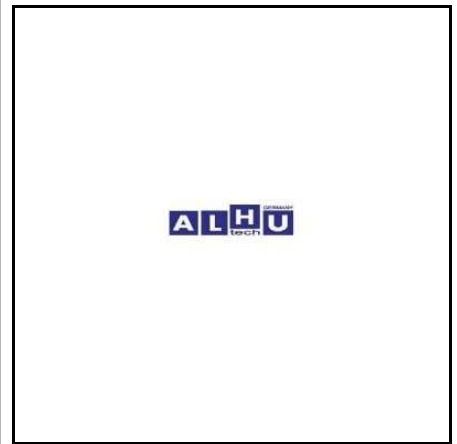

28 880 016 GAS SPRING

TGA TGS TGX

MAN
81.61140.0016

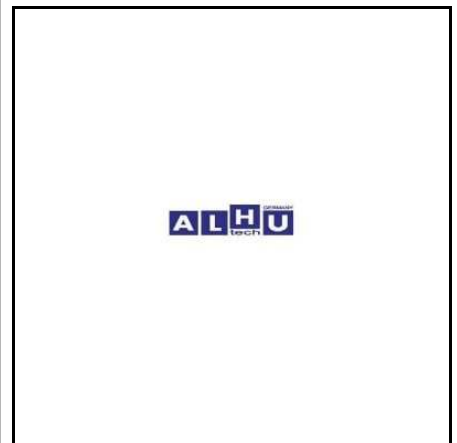

Kabine / Cabin

28 880 095 GAS SPRING

F 2000

MAN
81.74821.0095



28 880 149 GAS SPRING

TGA TGS TGX

MAN
81.74821.0149

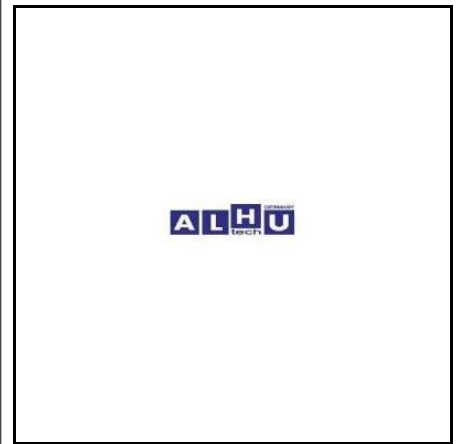

63 450 716 GAS SPRING

MAN
81.74821.0039

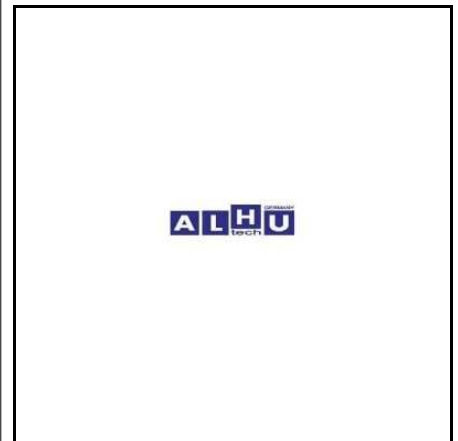

63 450 727 GAS SPRING
for tool box

MAN
81.97006.0033

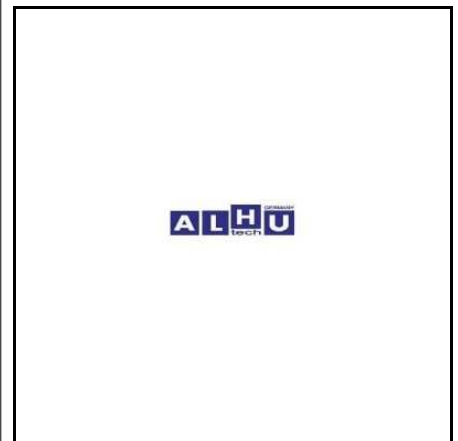

Kabine / Cabin

63 451 354 GAS SPRING

MAN
81.62900.6179



63 451 355 GAS SPRING

MAN
81.74821.0041



63 451 356 GAS SPRING

MAN
81.74821.0063



63 451 357 GAS SPRING

MAN
81.74821.0068

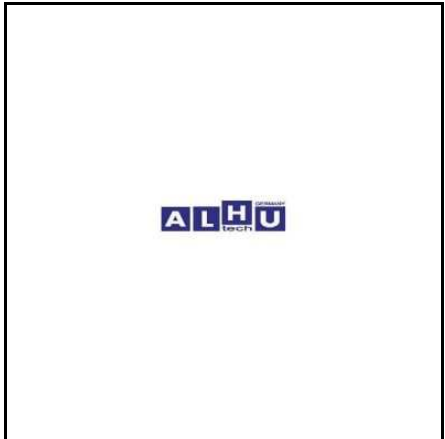

Kabine / Cabin

63 451 358 GAS SPRING

MAN
81.74821.0104

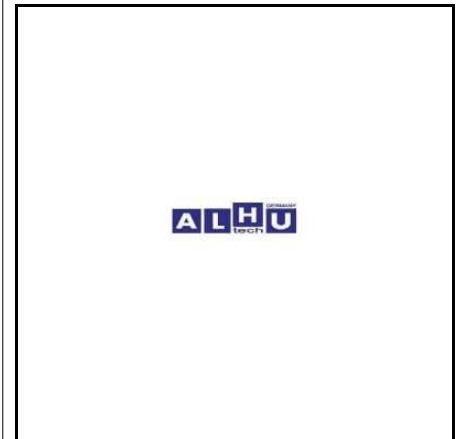

63 451 359 GAS SPRING

MAN
81.74821.0107

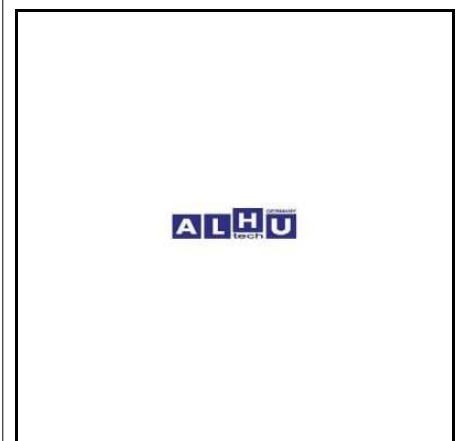

63 451 360 GAS SPRING

MAN
81.74821.0110

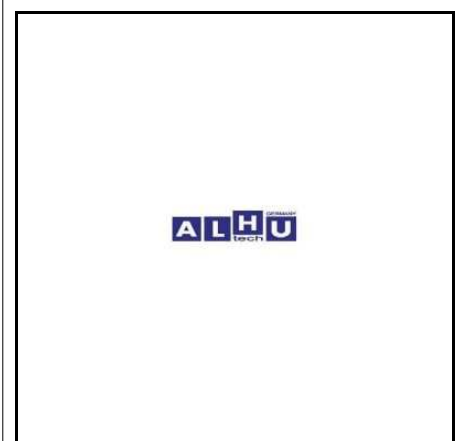

63 451 361 GAS SPRING

MAN
81.74821.0131

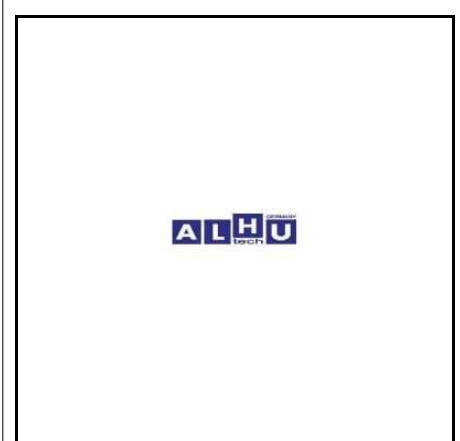

Kabine / Cabin

63 451 362 GAS SPRING

MAN
81.74821.0140



28 988 760 GLOVE BOX LOCK

MAN
81.61444.0003

Mercedes Benz
000 988 17 60



63 450 725 GRAB HANDLE
left

MAN
81.97001.5081



63 450 726 GRAB HANDLE
right

MAN
81.97001.5082



Kabine / Cabin

28 820 290	HEAD LAMP
	without adjustment. right
	F 2000
MAN	
81.25101.6290	



28 820 291	HEAD LAMP
	with range adjustment
	F 2000
MAN	
81.25101.6291	



28 820 292	HEAD LAMP
	with range adjustment
	F 2000
MAN	
81.25101.6292	



28 820 448	HEAD LAMP
	E-mark yes
	TGA
MAN	
81.25101.6448	

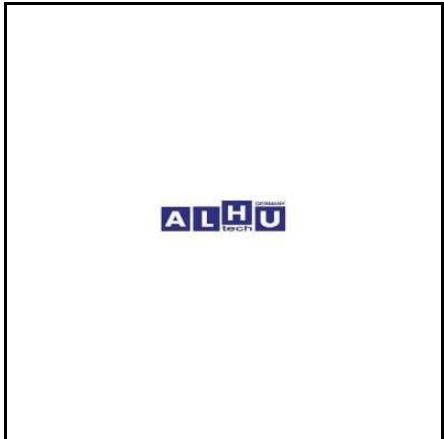

Kabine / Cabin

28 820 449	HEAD LAMP
E-mark yes	TGA
MAN 81.25101.6449	

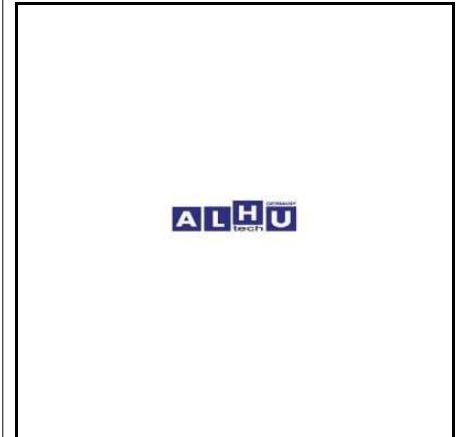

28 820 450	HEAD LAMP
E-mark yes	TGA
MAN 81.25101.6450	

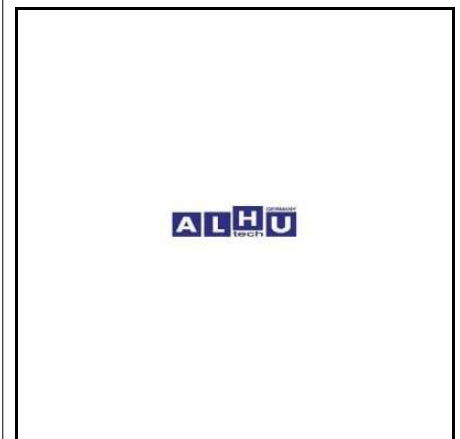

28 820 451	HEAD LAMP
E-mark yes	TGA
MAN 81.25101.6451	

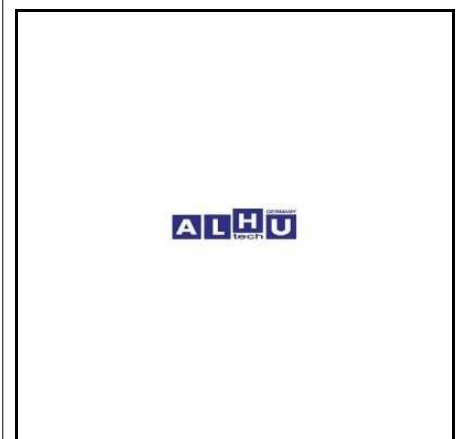

28 826 067	HEAD LAMP LENS
left - with E mark	F 2000
MAN 81.25110.0067	



Kabine / Cabin

28 826 068	HEAD LAMP LENS
	right with E mark
	F 2000
MAN	
81.25110.0068	

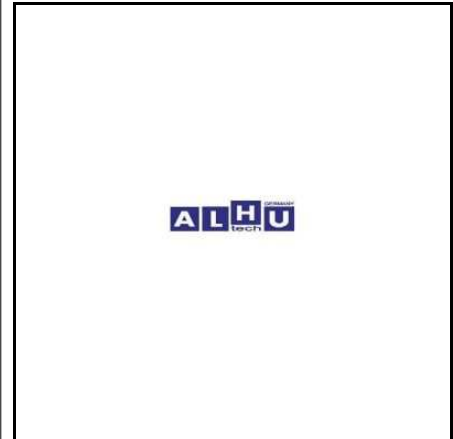

28 826 080	HEAD LAMP LENS
	left
	TGA
MAN	
81.25110.0080	

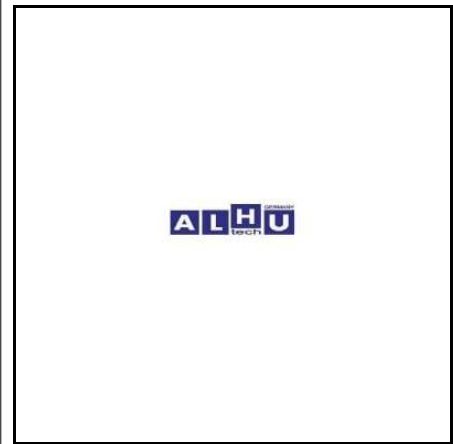

28 826 081	HEAD LAMP LENS
	right
	TGA
MAN	
81.25110.0081	

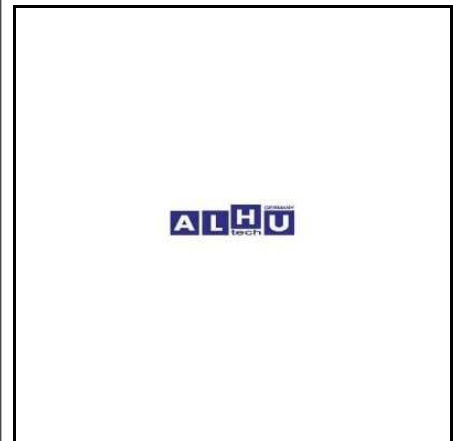

28 820 339	HEADLIGHTS AND FOGLIGHTS LEFT
	with E mark
	F 2000
MAN	
81.25101.6339	
81.25113.6021	

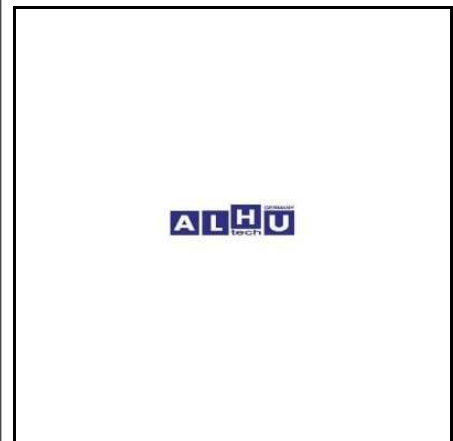

Kabine / Cabin

28 820 338 HEADLIGHTS AND FOGLIGHTS RIGHT
with E mark
F 2000

MAN
81.25101.6338
81.25113.6022

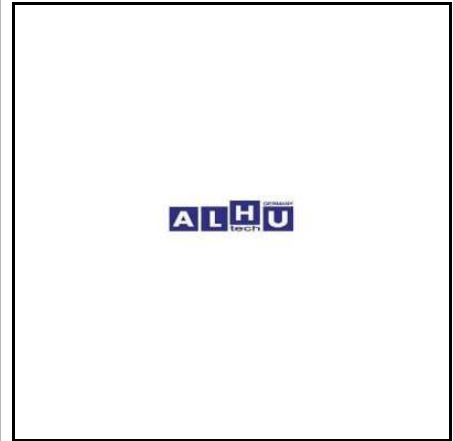

28 830 064 HEAT EXCHANGER
F 90

MAN
81.61901.0064

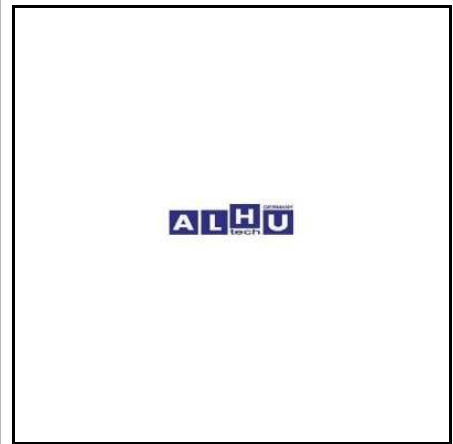

28 830 065 HEAT EXCHANGER
L 2000 / M 2000

MAN
81.61901.0065



28 830 066 HEAT EXCHANGER
TGA TGS TGX

MAN
81.61901.6166

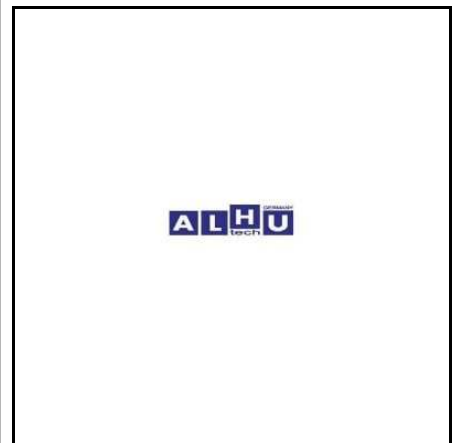

Kabine / Cabin

28 830 067 HEAT EXCHANGER

F 2000

MAN
81.61901.0067

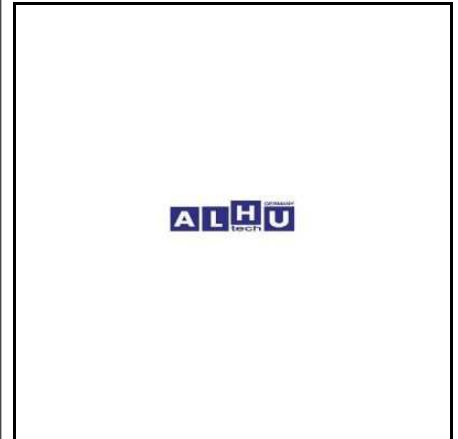

28 720 042 HINGE PART

MAN
81.62690.0042



28 720 047 HINGE PART

MAN
81.62690.0047



63 451 353 HOLDER

MAN
81.62158.5021

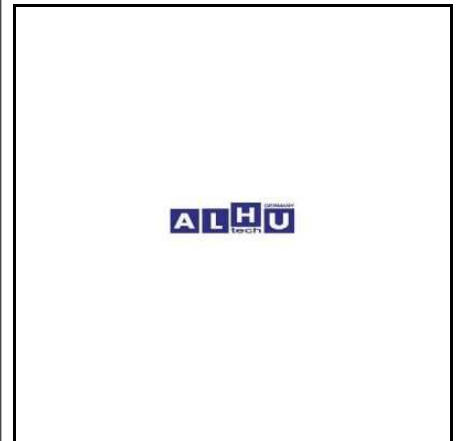

Kabine / Cabin

28 830 332 HOSE BEND

MAN
81.08201.0332



63 450 732 HOSE CLAMP

MAN
81.97440.0170



21 203 010 HOSE PIPE

TGA TGS TGX

MAN
06.54099.0121



25 260 006 INDICATOR LAMP

E-mark yes

F 2000

MAN
81.25320.6084



Kabine / Cabin

25 260 007 INDICATOR LAMP

MAN
81.25320.6087



28 320 001 INDICATOR LAMP
to fit 81 25320 6084

MAN
81.25229.0832



28 320 002 INDICATOR LAMP
E-mark yes
F 2000

MAN
81.25320.6082



28 830 028 INTAKE PIPE
F 2000

MAN
81.08201.6028



Kabine / Cabin

28 417 090 JOINT BEARING

MAN
81.41720.0090



25 229 889 LENS

MAN
81.25229.0889



28 229 603 LENS
FRONT INDICATOR

F 2000

MAN
81.25229.0603



26 421 068 LEVER, WINDSCREEN WIPER

MAN
81.26421.0068



Kabine / Cabin

63 450 660 LOCK PLATE

MAN
81.25140.0096



21 620 085 LOCK RING

MAN
81.90620.0085



28 971 034 LOCK SET

F 2000

MAN
81.97100.6034



28 971 098 LOCK SET

MAN
81.97100.6098



Kabine / Cabin

63 450 729 LOCK SET
left

MAN
81.97100.6030



63 450 730 LOCK SET
right

MAN
81.97100.6031



28 880 028 LOCK, GRILL

TGA TGS TGX

MAN
81.97122.0028



26 481 026 LOCK, WATER CONTAINER

MAN
81.26481.0026



Kabine / Cabin

25 810 430 MIRROR

TGA TGS TGX

MAN
81.63730.6430

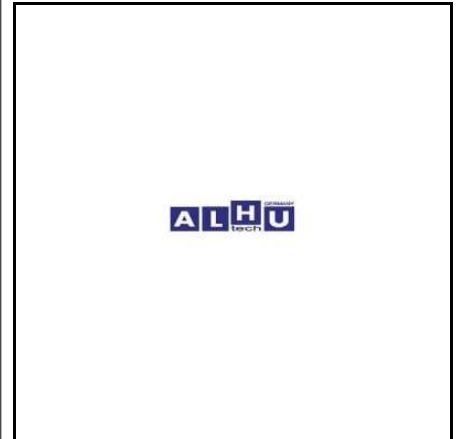

25 810 432 MIRROR

TGA TGS TGX

MAN
81.63730.6432

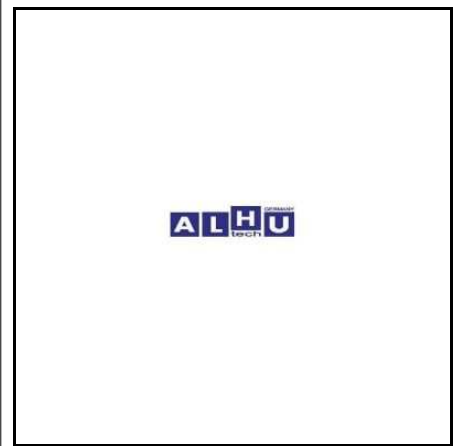

25 810 512 MIRROR

TGA TGS TGX

MAN
81.63730.6512

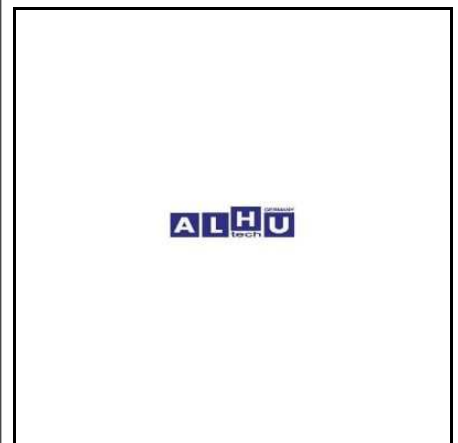

25 810 513 MIRROR

TGA TGS TGX

MAN
81.63730.6513

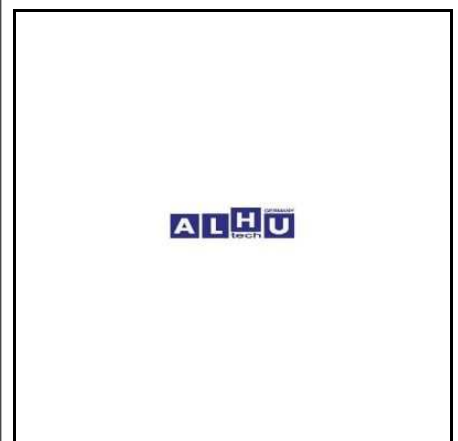

Kabine / Cabin

28 637 148	MIRROR
	WITH EU APPROVAL
	F7 F 90
MAN	
81.63730.6148	

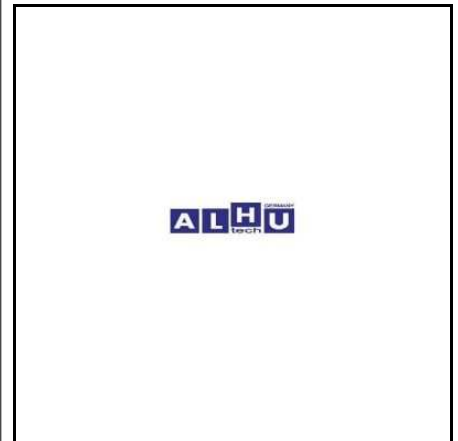

28 637 151	MIRROR
	HEATABLE, WITH EU
MAN	
81.63730.6151	

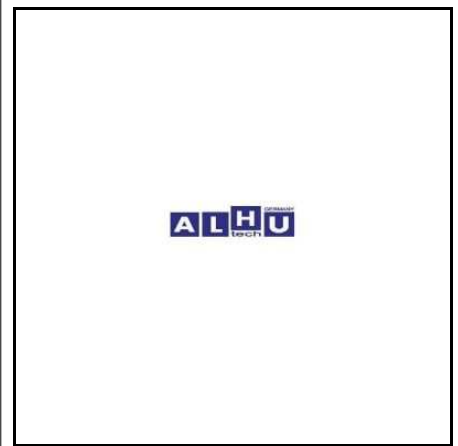

28 637 233	MIRROR
	WITH EU APPROVAL
	F 90
MAN	
81.63730.6233	

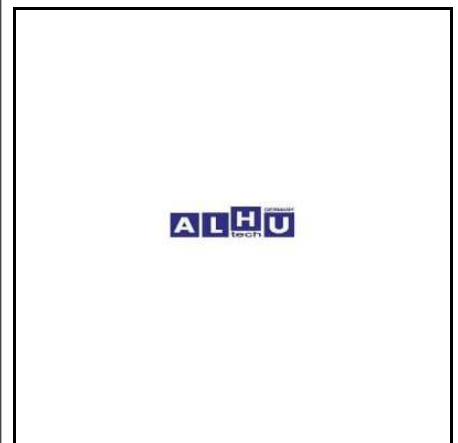

28 637 235	MIRROR
	WIDE-VIEW, WITH EU
	L 2000 M 2000
MAN	
81.63730.6235	

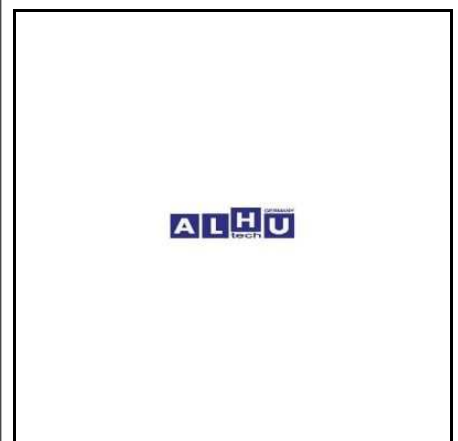

Kabine / Cabin

28 637 236	MIRROR
	WIDE-VIEW, WITH EU
	L 2000 M 2000
MAN	
81.63730.6236	

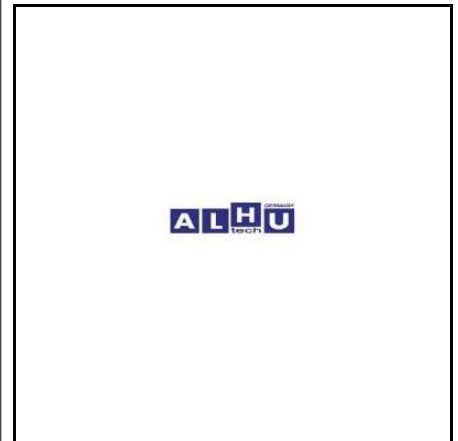

28 810 294	MIRROR
	CURB, WITHOUT EU APPROVAL
	F 2000
MAN	
81.63730.6294	

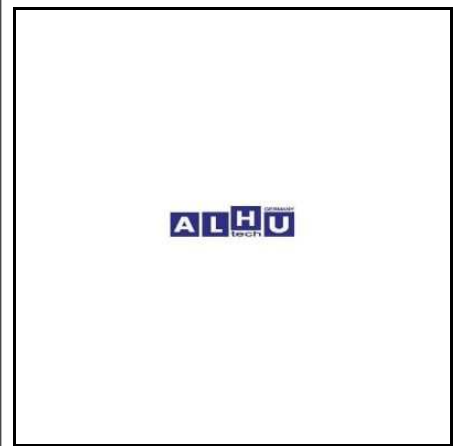

28 810 368	MIRROR
	WITHOUT EU APPROVAL
MAN	
81.63730.6364	
81.63730.6368	

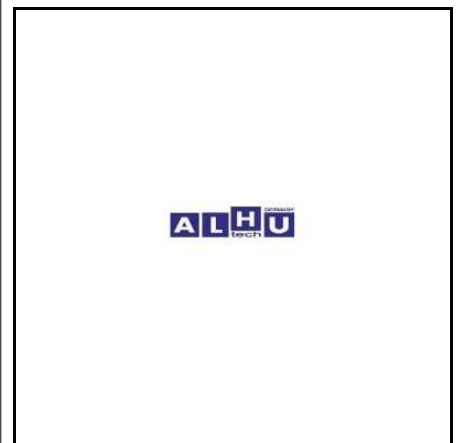

28 637 224	MIRROR GLASS
MAN	
81.63730.6224	

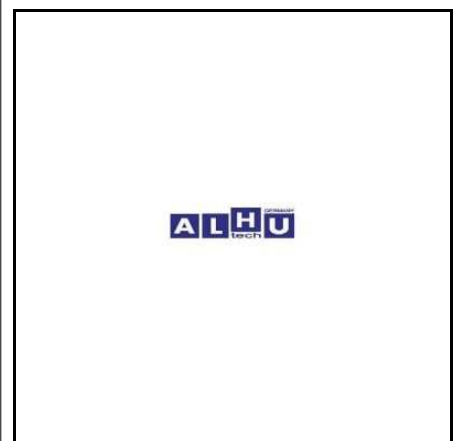

Kabine / Cabin

25 810 557 MIRROR ARM

TGA

MAN
81.63731.6557



25 810 560 MIRROR ARM

TGA

MAN
81.63731.6560



63 450 712 MIRROR ARM
right

MAN
81.63731.6566



63 450 713 MIRROR ARM
left

MAN
81.63731.6569



Kabine / Cabin

28 810 489	MIRROR BRACKET
	left
MAN	
81.63731.6489	



28 810 490	MIRROR BRACKET
	right
MAN	
81.63731.6490	



63 450 704	MIRROR BRACKET
MAN	
81.63731.0183	



63 450 705	MIRROR BRACKET
MAN	
81.63731.0197	



Kabine / Cabin

63 450 706 MIRROR BRACKET

MAN
81.63731.0228



63 450 709 MIRROR BRACKET
left

MAN
81.63731.6501



63 450 710 MIRROR BRACKET
right

MAN
81.63731.6502



63 450 114 MIRROR CAP

MAN
81.63731.0356



Kabine / Cabin

26 731 180 MIRROR COVER

MAN
81.63731.0180

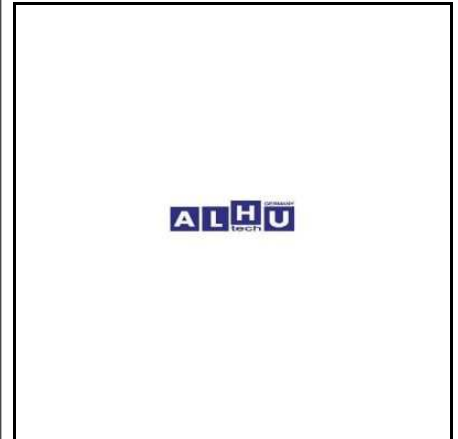

26 732 059 MIRROR COVER

TGA TGS TGX

MAN
81.63732.0059

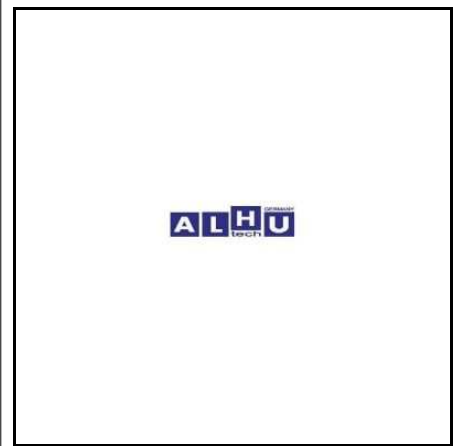

28 638 061 MIRROR COVER

left

TGA TGS TGX

MAN
81.63732.0061

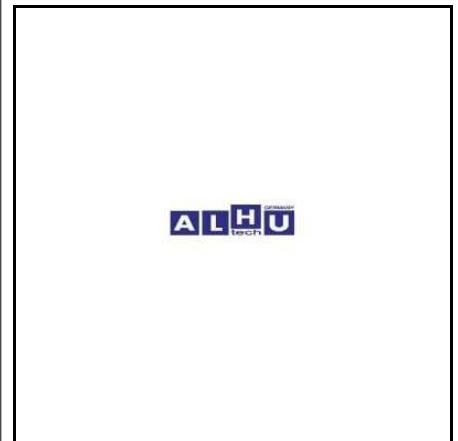

28 638 062 MIRROR COVER

right

TGA TGS TGX

MAN
81.63732.0062

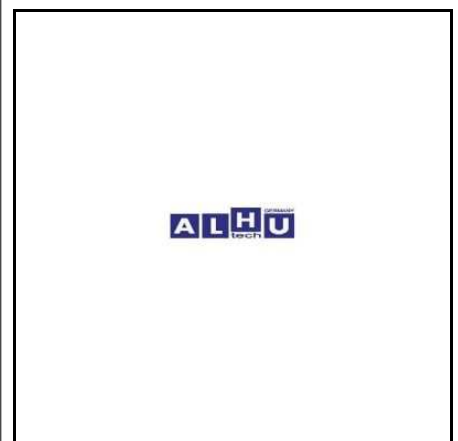

Kabine / Cabin

28 811 009 MIRROR COVER
left

MAN
85.63710.0009



28 811 010 MIRROR COVER
right

MAN
85.63710.0010

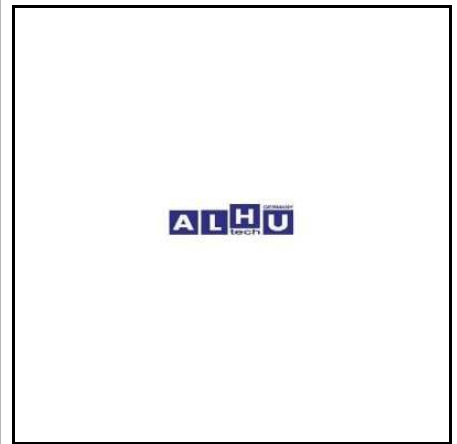

63 450 707 MIRROR COVER
right

MAN
81.63731.0260

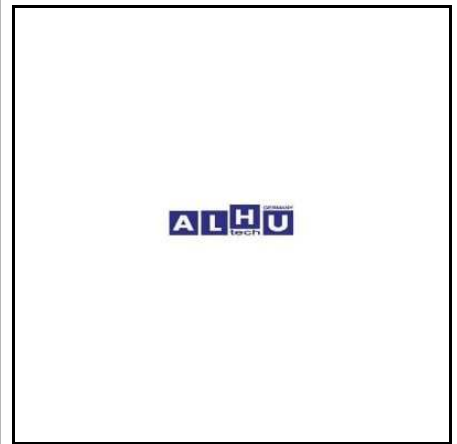

63 450 708 MIRROR COVER
left

MAN
81.63731.0261

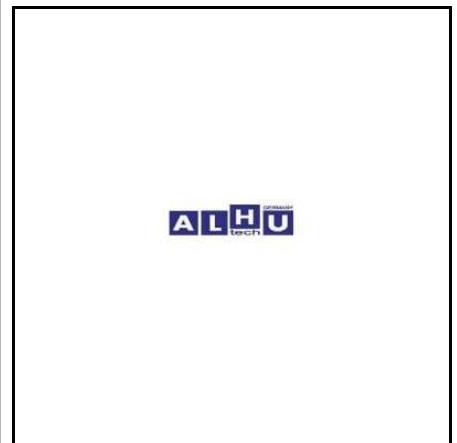

Kabine / Cabin

25 810 049 MIRROR GLASS

TGA TGS TGX

MAN
81.63733.6049



25 810 057 MIRROR GLASS

TGA TGS TGX

MAN
81.63733.6057



28 637 007 MIRROR GLASS

F 2000

MAN
81.63733.6007



28 637 027 MIRROR GLASS

L 2000 M 2000

MAN
81.63733.0027



Kabine / Cabin

28 637 030 MIRROR GLASS

MAN
81.63733.0030



28 637 061 MIRROR GLASS

L 2000 M 2000

MAN
81.63733.0061



26 641 293 MUDGUARD

TGA TGS TGX

MAN
81.66410.0293



26 641 294 MUDGUARD

TGA TGS TGX

MAN
81.66410.0294



Kabine / Cabin

26 660 013 MUDGUARD

MAN
81.66410.0172



26 660 014 MUDGUARD

MAN
81.66410.0173



26 660 015 MUDGUARD

MAN
81.66410.6086



26 660 016 MUDGUARD

MAN
81.66410.6606



Kabine / Cabin

28 880 086	MUDGUARD
	690 MM
	TGA
MAN	
81.66410.0086	



28 880 310	MUDGUARD
MAN	
81.61210.5310	



28 880 311	MUDGUARD
	F 2000
MAN	
81.61210.5311	



28 880 352	MUDGUARD
	REAR, RIGHT
	F 2000
MAN	
81.66410.0352	



Kabine / Cabin

28 880 353	MUDGUARD
	REAR, LEFT
	F 2000
MAN	
81.66410.0353	



28 880 363	MUDGUARD
	LEFT
	F 2000
MAN	
81.61210.5363	

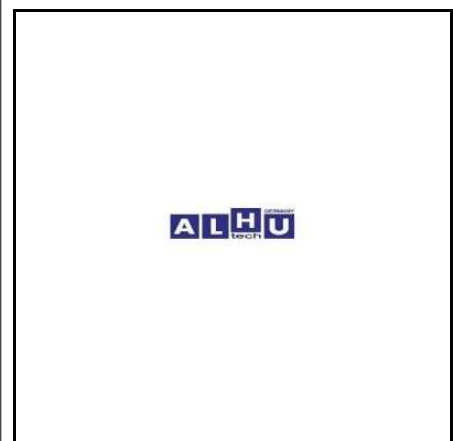

28 881 080	MUDGUARD
	RIGHT, REAR
	F 2000
MAN	
81.66410.5080	



28 881 081	MUDGUARD
	RIGHT, REAR
	F 90
MAN	
81.66410.5081	



Kabine / Cabin

26 641 306 MUDGUARD TRIM PLATE

MAN
81.66410.0306



26 641 307 MUDGUARD TRIM PLATE

MAN
81.66410.0307



26 641 308 MUDGUARD TRIM PLATE

MAN
81.66410.0308



26 641 309 MUDGUARD TRIM PLATE

MAN
81.66410.0309



Kabine / Cabin

26 660 009 MUDGUARDS EXTENSION

MAN
81.61510.0410



26 660 010 MUDGUARDS EXTENSION

MAN
81.61510.0411



28 660 409 MUDGUARDS EXTENSION, LEFT

MAN
81.61510.0409



28 660 408 MUDGUARDS EXTENSION, RIGHT

MAN
81.61510.0408



Kabine / Cabin

26 503 443 OIL SEAL

MAN
81.96503.0443



26 611 063 PANEL

TGA TGS TGX

MAN
81.61110.0063



26 000 001 PEDAL PAD

MAN
81.48227.0006



28 723 007 PIN

MAN
81.62691.0007



Kabine / Cabin

28 619 001 POLLEN FILTER

TGA TGS TGX

MAN
81.61910.0019

Mann + Hummel
CUK 4795



28 619 002 POLLEN FILTER

L 2000 M 2000

MAN
85.61950.0025



28 619 003 POLLEN FILTER

F 2000

MAN
81.61910.0011



28 619 004 POLLEN FILTER

TGA TGS TGX

MAN
81.61910.0018

Mann + Hummel
CU 4795



Kabine / Cabin

28 720 101 PULL HANDLE

MAN
81.62641.0101



28 880 050 RADIATOR GRILLE

MAN
81.61150.6050

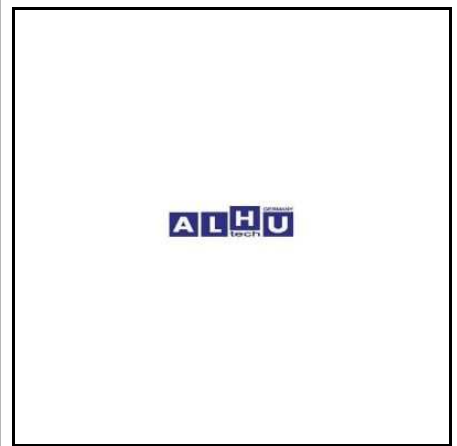

28 880 051 RADIATOR GRILLE

TGA TGS TGX

MAN
81.61150.6051

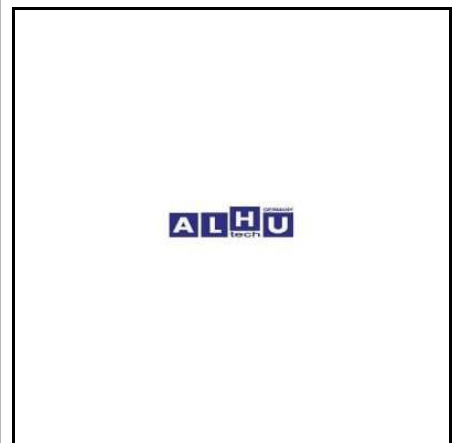

28 888 060 RADIATOR GRILLE

F 2000

MAN
81.61150.5060



Kabine / Cabin

63 450 098 REAR LAMP LENS

MAN
81.25229.6042



28 881 046 REFLECTOR

MAN
81.42950.0046



28 881 060 REFLECTOR

MAN
81.42950.0060



28 881 071 REFLECTOR YELLOW

MAN
81.42950.0071



Kabine / Cabin

63 450 568	REPAIR KIT
for GRAMMER seat	
MAN	
83.78611.6001	



63 450 711	REPAIR KIT
mirror holder	
MAN	
81.63731.6550	



63 450 714	REPAIR KIT
mirror holder	
MAN	
81.63731.6621	



63 450 715	REPAIR KIT
mirror holder	
MAN	
81.63731.6622	



Kabine / Cabin

26 641 097 REPAIR KIT OUTSIDE DOOR HANDLE

TGX

MAN
81.62641.6097



28 890 013 REP. KIT CABIN MOUNTING

TGA TGS TGX

MAN
81.41715.6013



28 890 014 REP. KIT CABIN MOUNTING

TGA TGS TGX

MAN
81.41715.6014



63 450 093 REP. KIT, CAB SUSPENSION

F 2000

MAN
81.41700.6095



Kabine / Cabin

28 820 340	RETAINING FRAME, LEFT
LH	F 2000
MAN	
81.25115.0023	

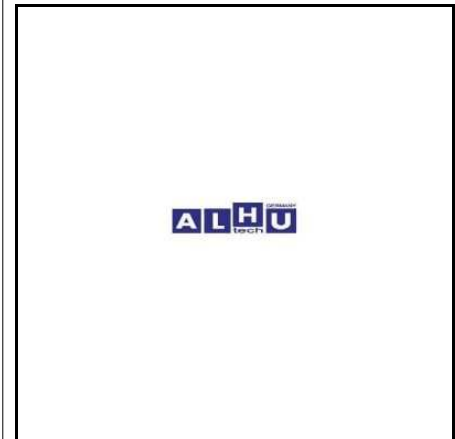

28 820 341	RETAINING FRAME, RIGHT
RH	F 2000
MAN	
81.25115.0022	

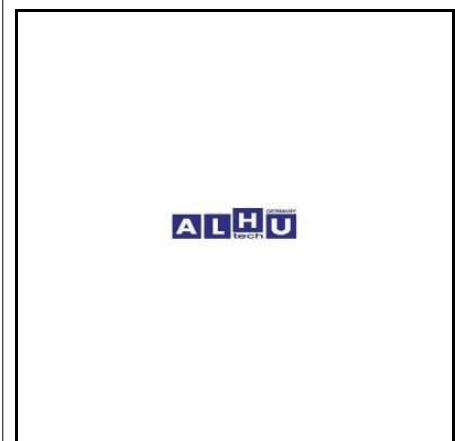

63 450 552	RETAINING PLATE
MAN	
81.74364.0009	

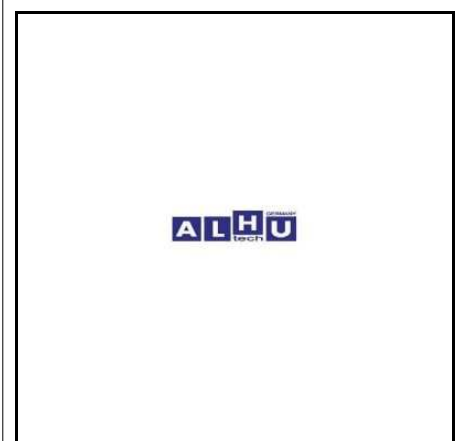

28 252 784	REVERSE LIGHT LENS
MAN	
81.25229.0784	
Mercedes Benz	
001 544 92 90	



Kabine / Cabin

63 450 240 ROLLER GUIDE

MAN
81.74940.6420



63 450 241 ROLLER GUIDE

MAN
81.74940.6421



26 240 001 RUBBER BUFFER
cab suspension

MAN
81.96210.0430



63 450 129 RUBBER BUFFER

MAN
88.96210.0057



Kabine / Cabin

28 520 192 RUBBER FOR FENDER

TGA TGS TGX

MAN
81.66440.0192



28 522 067 RUBBER FOR FENDER

ACTROS TGA TGS

MAN
81.66410.0226

Mercedes Benz
941 522 00 67



63 450 200 RUBBER MOUNTING

MAN
81.96210.0247



26 503 129 SEAL RING

MAN
81.96503.0129



Kabine / Cabin

63 450 279 SEALING FRAME

F 2000

MAN
81.62651.0075



26 398 004 SEAT LEVELLING VALVE KIT

MAN
81.62398.6004



26 340 063 SEAT REPAIR KIT

left

F 2000

MAN
81.62340.6063



26 340 064 SEAT REPAIR KIT

right

F 2000

MAN
81.62340.6064



Kabine / Cabin

26 383 055 SEAT REPAIR KIT	
	F 2000
MAN 81.62383.6055	



26 383 057 SEAT REPAIR KIT	
	F 2000
MAN 81.62383.6057	



26 384 008 SEAT REPAIR KIT	
control valve	F 2000
MAN 81.62384.6008	



26 385 033 SEAT REPAIR KIT	
	F 2000
MAN 81.62385.6033	



Kabine / Cabin

26 392 003 SEAT REPAIR KIT

MAN
81.62392.6003



26 398 018 SEAT REPAIR KIT

MAN
81.62398.6018



26 398 019 SEAT REPAIR KIT

MAN
81.62398.6019



26 385 025 SHOCK ABSORBER KIT

MAN
81.62385.6025



Kabine / Cabin

28 826 104 SIDE MARKER LAMP

L 2000

MAN
81.25260.6104

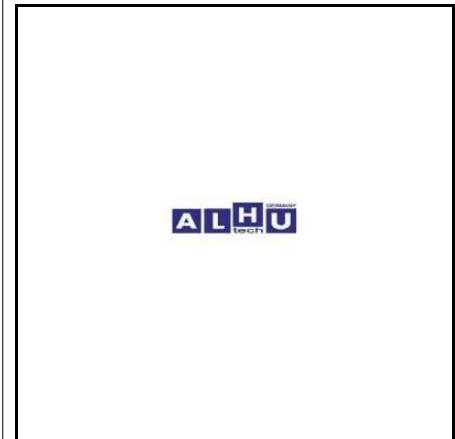

25 260 004 SIDE MARKER LIGHT

E-mark yes
F 2000

MAN
81.25260.6105

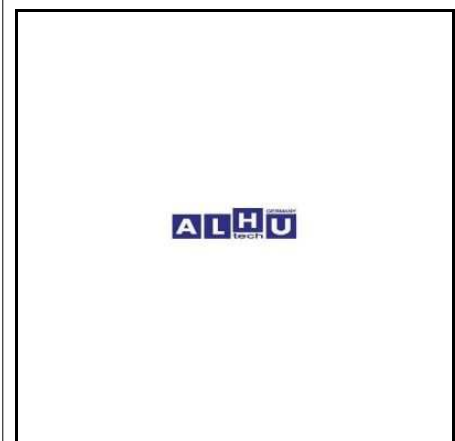

28 820 101 SIDE MARKER LIGHT

E-mark yes
F 2000

MAN
81.25260.6101



28 620 224 SIDE TRIM

MAN
81.62410.2224

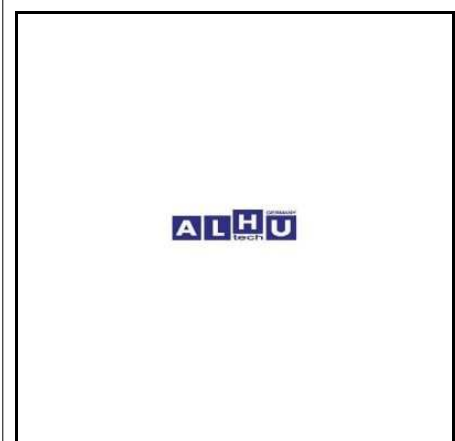

Kabine / Cabin

28 620 225 SIDE TRIM

MAN
81.62410.2225



63 450 215 SNAP LOCK

MAN
36.97116.0000
81.97116.0099

Mercedes Benz
357 750 00 50



28 660 196 STEP
LOWER, RIGHT

F 2000

MAN
81.61510.5196



28 660 197 STEP
LOWER, LEFT

MAN
81.61510.5197



Kabine / Cabin

28 660 262	STEP
	CENTRE, RIGHT
	F 2000
MAN	
81.61510.0262	



28 660 263	STEP
	CENTRE, LEFT
MAN	
81.61510.0263	

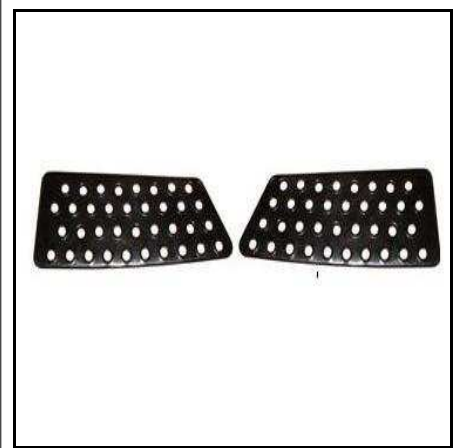

28 660 267	STEP
	UPPER, LEFT
	F 2000
MAN	
81.61510.0267	

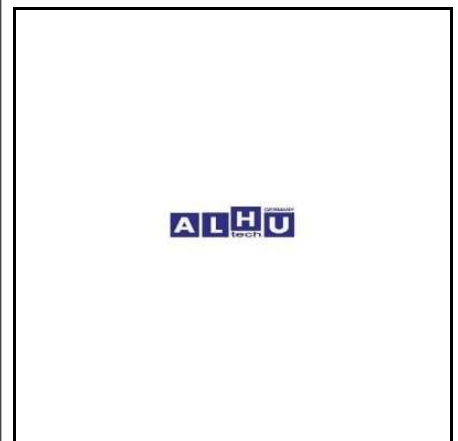

28 660 268	STEP
	UPPER, RIGHT
	F 2000
MAN	
81.61510.0268	

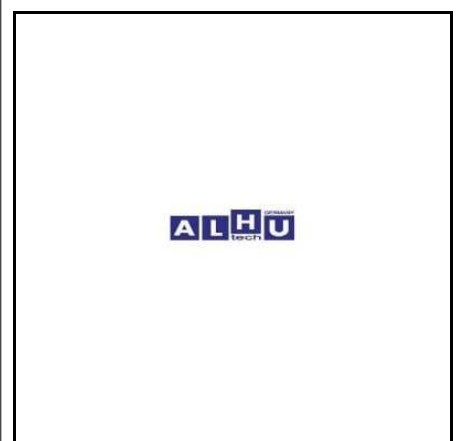

Kabine / Cabin

28 666 001 STEP

MAN
81.61511.0001



26 210 021 STEP HOUSING

MAN
85.61210.0021



26 210 022 STEP HOUSING

MAN
85.61210.0022



28 666 187 STEP LOWER

TGA TGS TGX

MAN
81.61510.5187



Kabine / Cabin

28 666 273 STEP UPPER

TGA TGX

MAN
81.61510.0273



28 660 027 STEPWELL

MAN
85.61510.5027

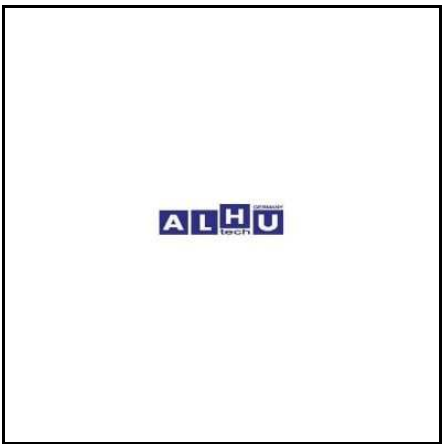

28 660 028 STEPWELL

MAN
85.61510.5028

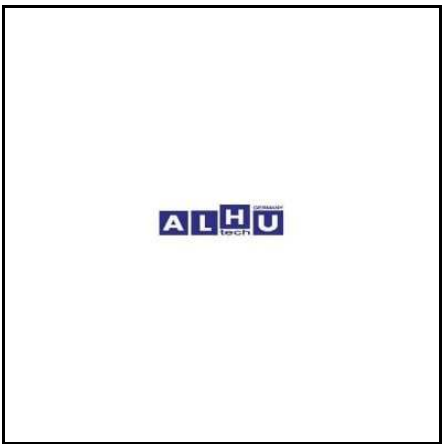

28 660 130 STEPWELL
RIGHT

MAN
81.61510.0130

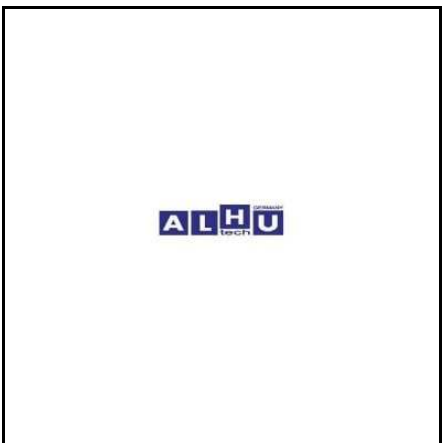

Kabine / Cabin

28 660 141 STEPWELL

MAN
81.61510.0158



28 660 142 STEPWELL

MAN
81.61510.0159



28 660 181 STEPWELL
left and right

F 2000

MAN
81.61510.5181



28 660 225 STEPWELL
LEFT

F 2000

MAN
81.61510.0225

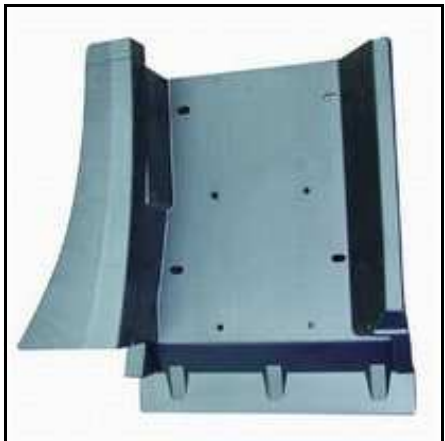

Kabine / Cabin

28 660 226	STEPWELL
	RIGHT
	F 2000
MAN	
81.61510.0226	

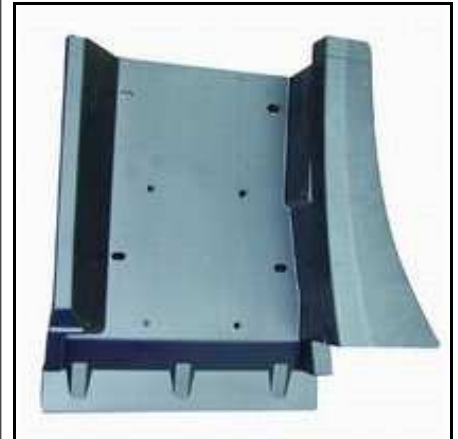

28 660 229	STEPWELL
	LEFT
	F 2000
MAN	
81.61510.0229	



28 660 230	STEPWELL
	RIGHT
	F 2000
MAN	
81.61510.0230	



28 660 333	STEPWELL
	LOWER, LEFT
	TGA TGS TGX
MAN	
81.61510.0333	

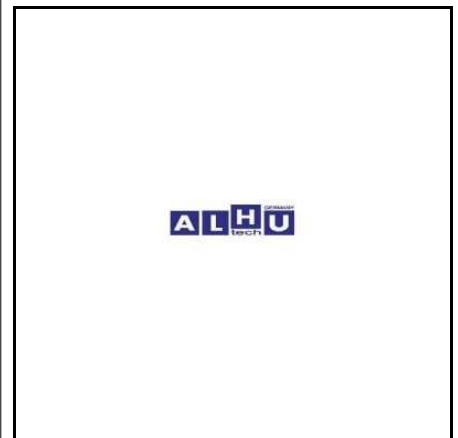

Kabine / Cabin

28 660 374	STEPWELL
	LOWER, RIGHT
	TGA TGS TGX
MAN	
81.61510.0374	

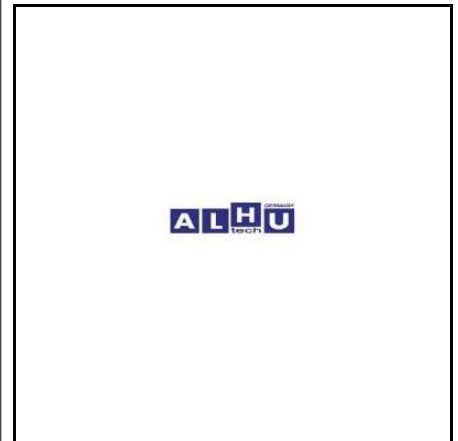

28 660 401	STEPWELL
	LEFT
	TGA TGX
MAN	
81.61510.0401	

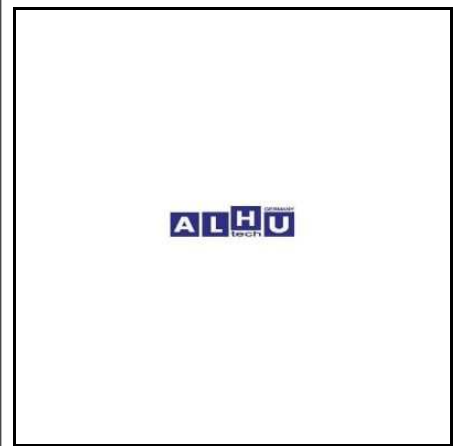

28 666 355	STEPWELL
	LEFT,LOWER
MAN	
81.61510.0355	

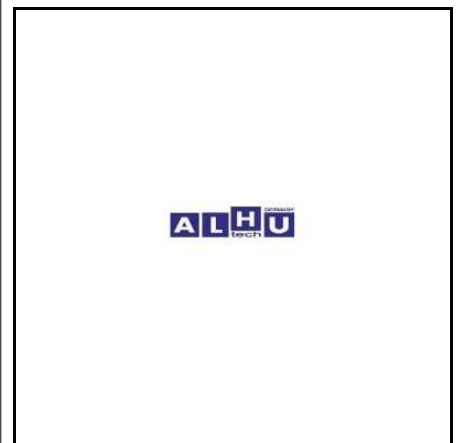

28 666 382	STEPWELL
	RIGHT,LOWER
MAN	
81.61510.0382	

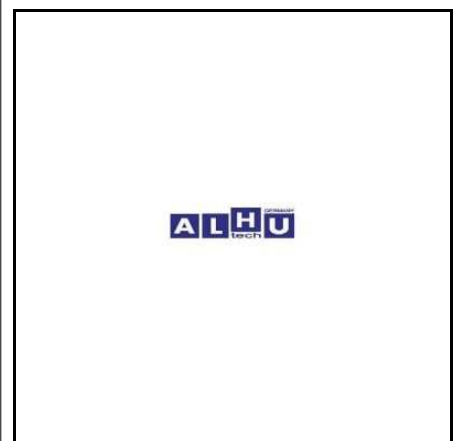

Kabine / Cabin

28 660 129 STEPWELL LEFT

MAN
81.61510.0129

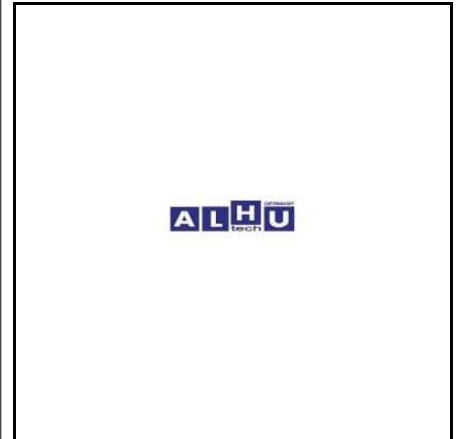

28 660 402 STEPWELL RIGHT
RIGHT

TGA TGX

MAN
81.61510.0402

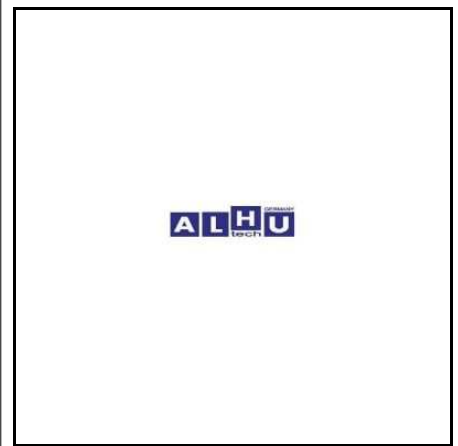

28 723 055 STRIKER PLATE

MAN
81.62680.0055

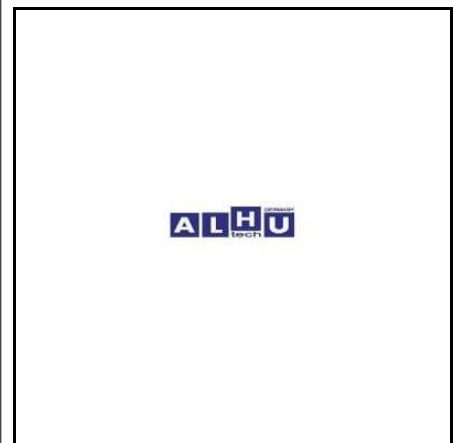

63 450 691 STRIKER PLATE LEFT

MAN
81.62540.7000

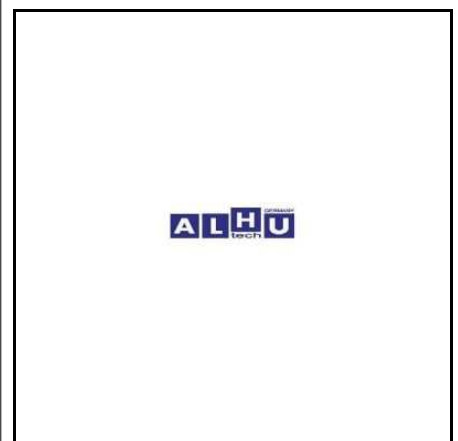

Kabine / Cabin

63 450 692 STRIKER PLATE RIGHT

MAN
81.62540.7001

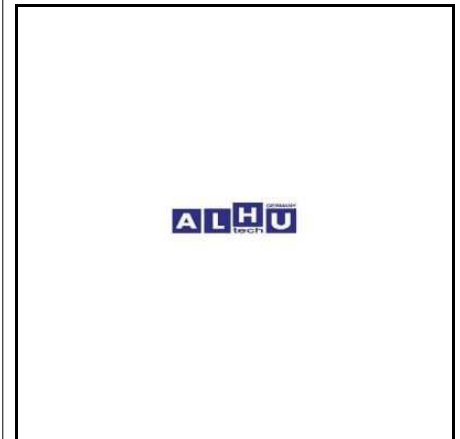

26 660 011 SUN VISOR

MAN
81.63701.0044

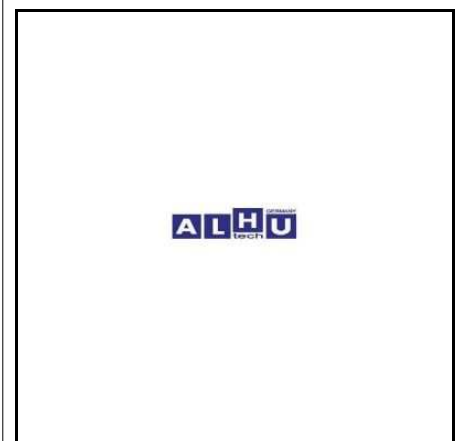

26 660 012 SUN VISOR

MAN
81.63701.0057

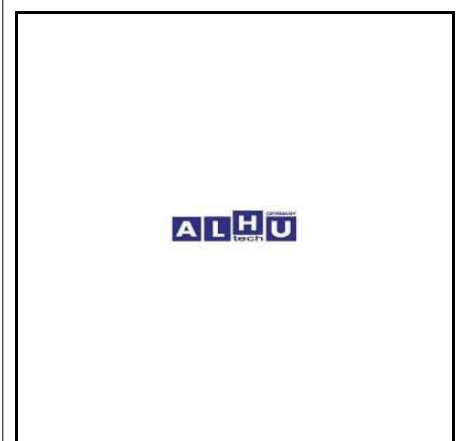

28 701 021 SUN VISOR

MAN
81.63701.0021

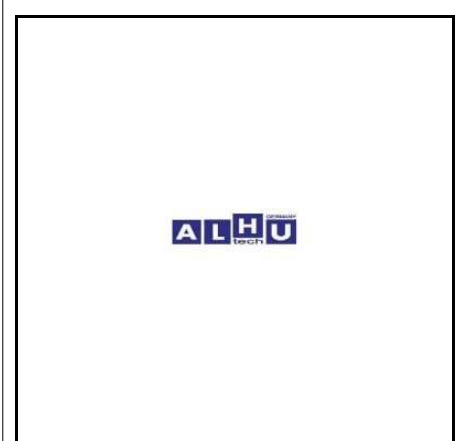

Kabine / Cabin

28 692 001 SUPPORT

F 2000

MAN
81.62692.5001



28 252 033 TAIL LAMP
right

F 2000

MAN
81.25228.6033

TA501
168100



28 252 034 TAIL LAMP
left

F 2000

MAN
81.25228.6034

TA501
168090



28 252 523 TAIL LAMP
right

TGA

MAN
81.25225.6523

TA501
169170



Kabine / Cabin

28 252 524 TAIL LAMP	
left	TGA
MAN 81.25225.6524	
TA501 169160	



28 540 001 TAIL LAMP	
	TGA
MAN 81.25225.6547	
TA501 156220	

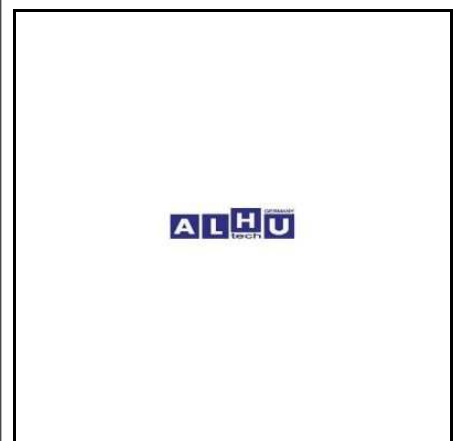

28 540 002 TAIL LAMP	
with E mark	TGA
MAN 81.25225.6544	
TA501 156200	

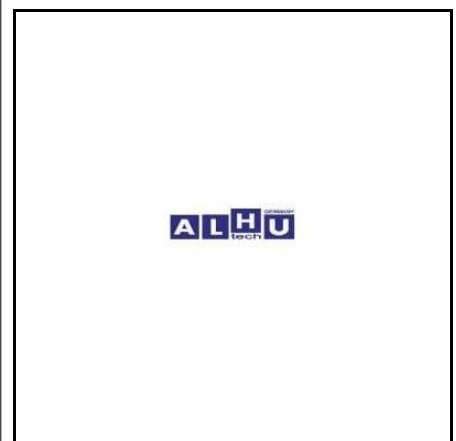

28 540 022 TAIL LAMP	
with E mark	
MAN 81.25225.6545	

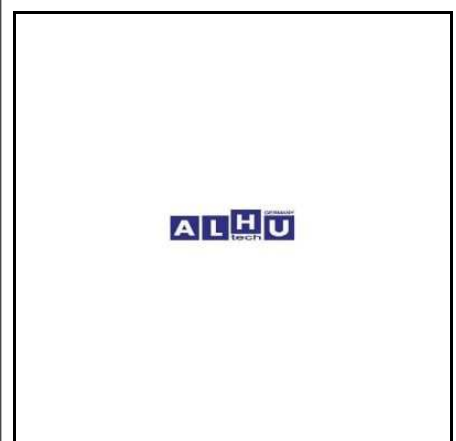

Kabine / Cabin

63 450 209 TAIL LAMP

left, with E mark

MAN

81.25225.6511

**63 450 210 TAIL LAMP**

right, with E mark

MAN

81.25225.6510

**63 450 662 TAIL LAMP**

left

MAN

81.25225.6259

**63 450 663 TAIL LAMP**

right

MAN

81.25225.6260



Kabine / Cabin

28 252 051 TAIL LAMP LENS
 with screws
 F 2000 TGA

MAN
 81.25229.6051

TA501
 067500



28 540 005 TAIL LAMP LENS
 with E mark

MAN
 81.25229.6059



28 540 006 TAIL LAMP LENS
 with E mark

MAN
 81.25229.6060



26 745 016 TOOL BOX DOOR
 right

MAN
 81.63745.0016

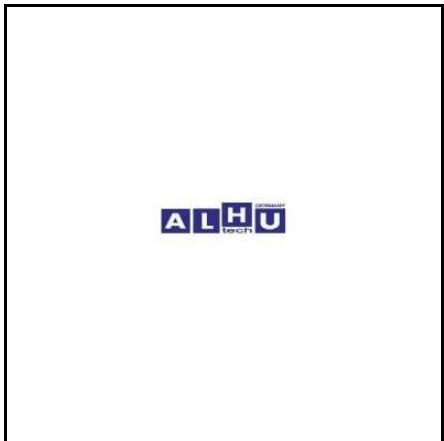

Kabine / Cabin

26 745 017	TOOL BOX DOOR
	left
MAN	
81.63745.0017	

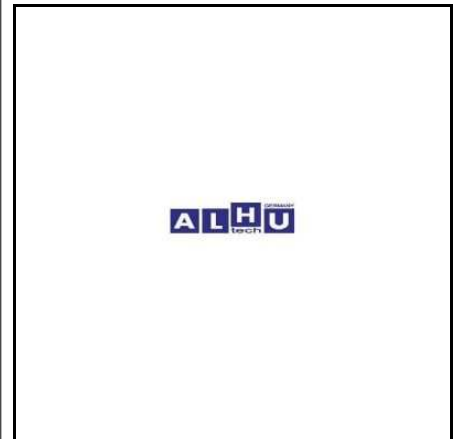

28 660 161	TRIM
	LEFT
	F 2000
MAN	
81.61510.5161	

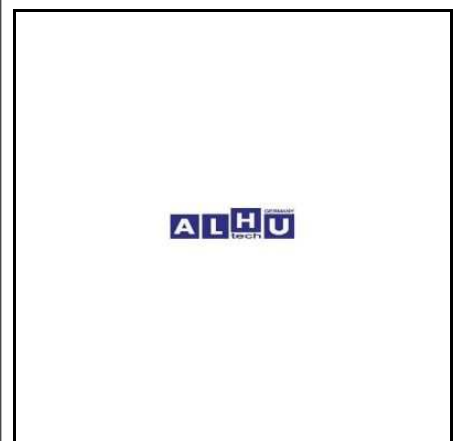

28 660 162	TRIM
	RIGHT
	F 2000
MAN	
81.61510.5162	



28 660 163	TRIM
	LEFT
	F 2000
MAN	
81.61510.5163	

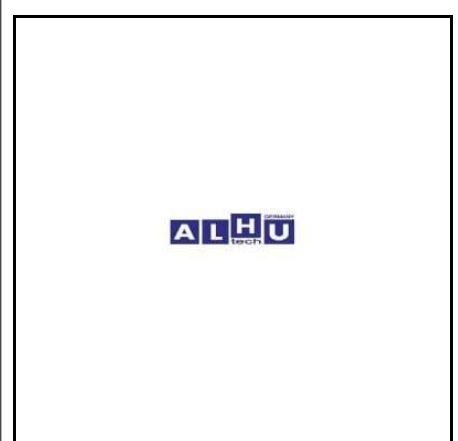

Kabine / Cabin

28 660 164	TRIM
	RIGHT
	F 2000
MAN	
81.61510.5164	

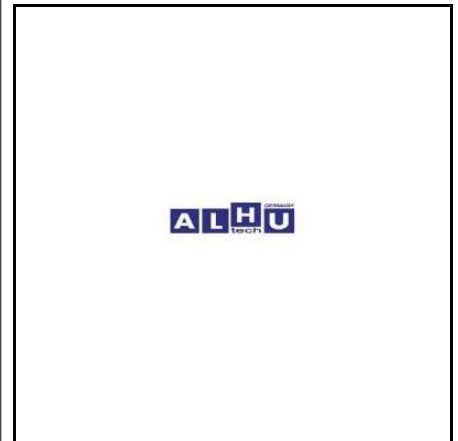

28 880 044	TRIM
	GRAINED
	TGA
MAN	
81.41685.0044	

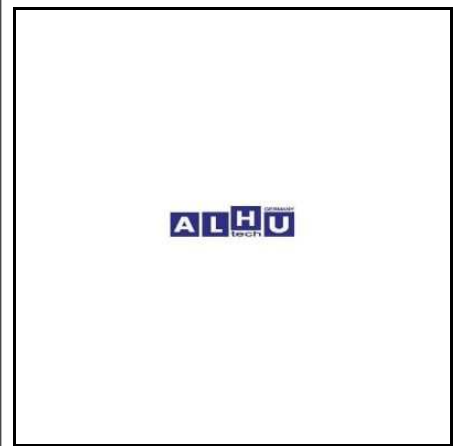

28 880 164	TRIM
	CENTER
	F 2000
MAN	
81.41610.0164	

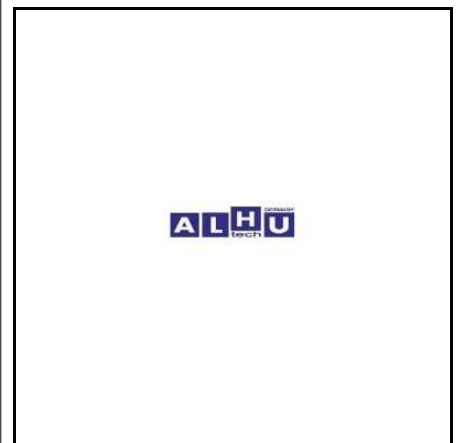

28 880 166	TRIM
	RIGHT
	F 2000
MAN	
81.41610.0166	

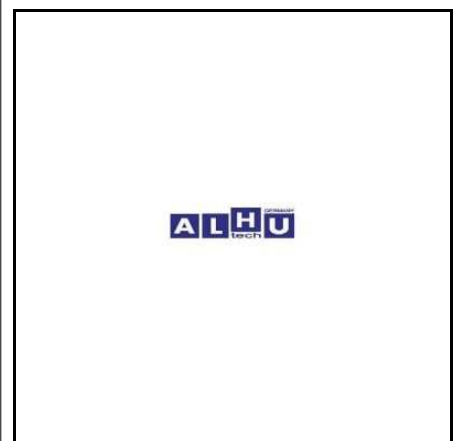

Kabine / Cabin

28 880 167	TRIM
	LEFT
	F 2000
MAN	
81.41610.0167	

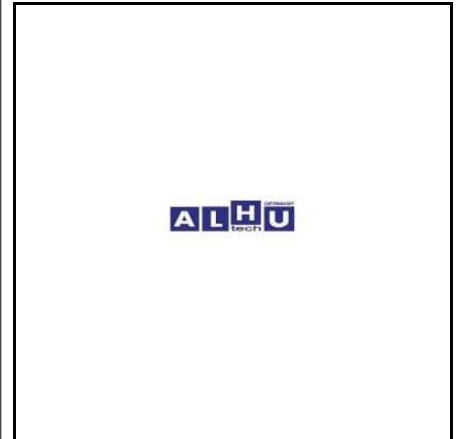

63 450 577	TRIM LEFT
MAN	
81.41610.0161	

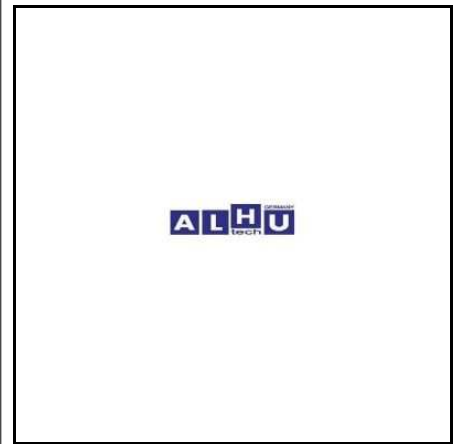

63 450 576	TRIM RIGHT
MAN	
81.41610.0160	

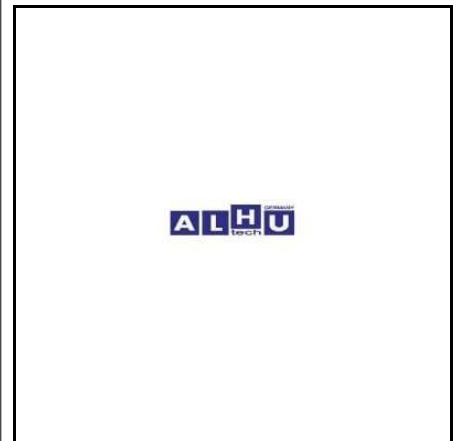

26 444 013	TURN LOCK
MAN	
81.61444.0013	

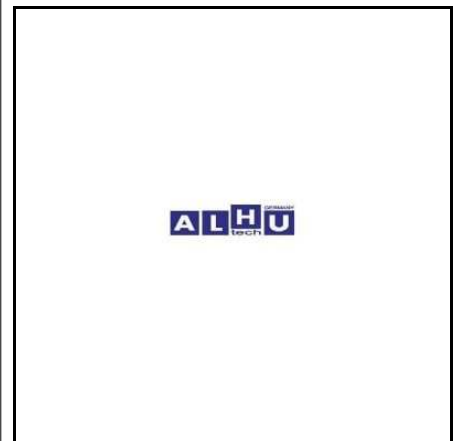

Kabine / Cabin

28 720 001 WEATHERSTRIP

MAN
81.96120.0001



28 720 002 WEATHERSTRIP

MAN
81.96120.0002



63 450 216 WEATHERSTRIP
left

MAN
81.96101.0733



63 450 217 WEATHERSTRIP
right

MAN
81.96101.0732



Kabine / Cabin

26 624 089 WIND DEFLECTOR
LEFT

MAN
81.62410.0089



26 624 090 WIND DEFLECTOR
RIGHT

MAN
81.62410.0090



26 660 008 WIND DEFLECTOR LEFT

MAN
81.61110.6049



28 790 049 WIND DEFLECTOR LEFT

TGA

MAN
81.62410.0049



Kabine / Cabin

28 790 063 WIND DEFLECTOR LEFT

F 2000

MAN
81.62410.0063



26 660 007 WIND DEFLECTOR RIGHT

MAN
81.61110.6048



28 790 048 WIND DEFLECTOR RIGHT

TGA

MAN
81.62410.0048



28 790 064 WIND DEFLECTOR RIGHT

TGA TGS TGX

MAN
81.62410.0064



Kabine / Cabin

28 760 052 WINDOW CRANK

MAN
81.62641.6052

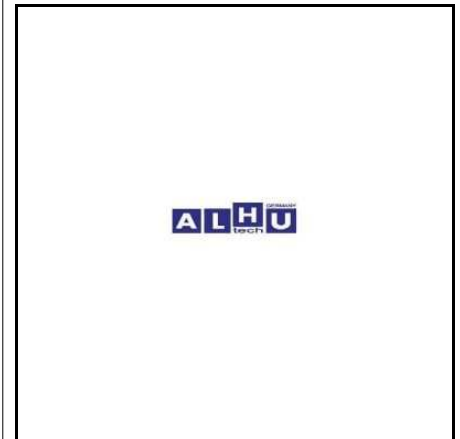

63 450 698 WINDOW CRANK

MAN
81.62641.0076

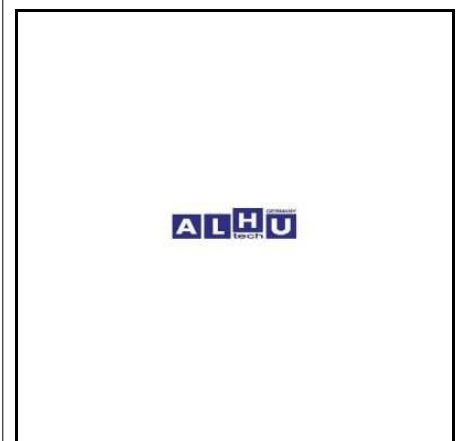

63 450 701 WINDOW CRANK
black

MAN
81.62641.6004

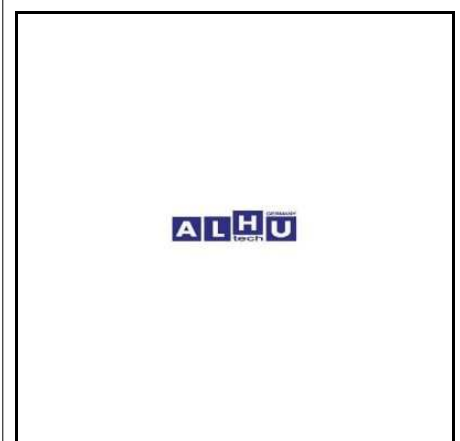

28 725 047 WINDOW FRAME, LEFT

MAN
81.62630.0047

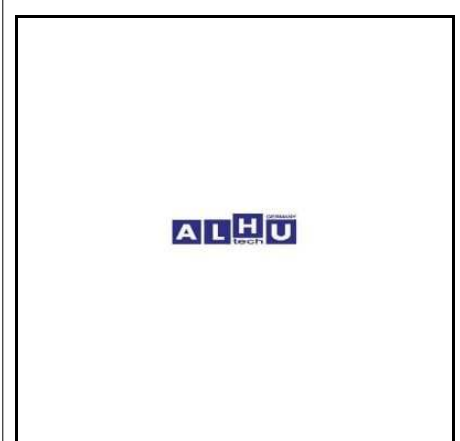

Kabine / Cabin

28 725 048 WINDOW FRAME, RIGHT

MAN
81.62630.0048

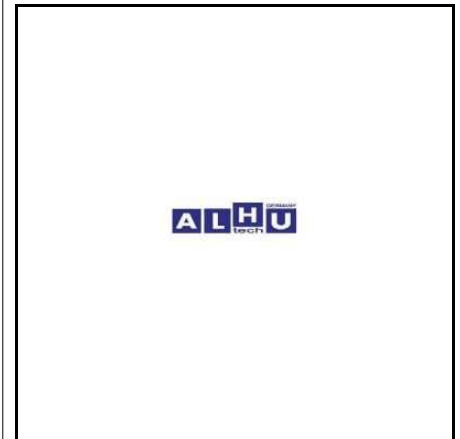

28 742 004 WINDOW MOTOR
right

F 2000

MAN
81.74249.6004

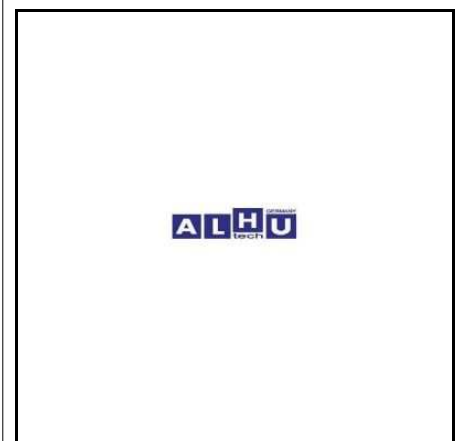

28 742 005 WINDOW MOTOR
left

F 2000

MAN
81.74249.6005

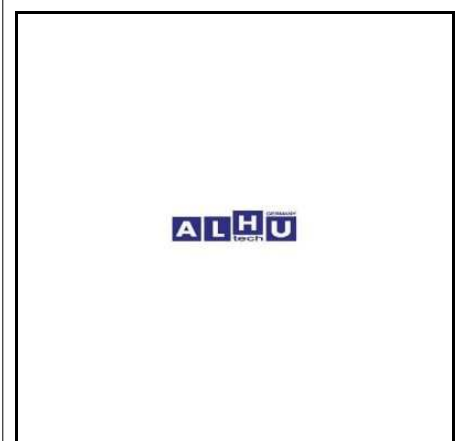

26 640 011 WINDOW REGULATOR
left

MAN
85.62640.6011

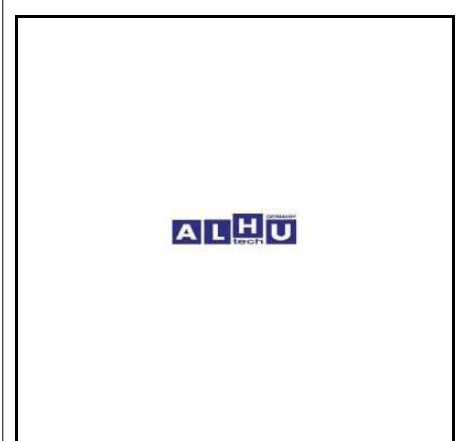

Kabine / Cabin

26 640 012 WINDOW REGULATOR
right

MAN
85.62640.6012



28 640 055 WINDOW REGULATOR
FRONT, LEFT

F 2000

MAN
81.62640.6055



28 640 056 WINDOW REGULATOR
FRONT, RIGHT

F 2000

MAN
81.62640.6056



28 721 046 WINDOW REGULATOR
left

MAN
81.62640.6057



Kabine / Cabin

28 721 146 WINDOW REGULATOR
right

MAN
81.62640.6058



63 450 693 WINDOW REGULATOR
right

MAN
81.62640.6010



63 450 694 WINDOW REGULATOR
left

MAN
81.62640.6011



63 450 695 WINDOW REGULATOR
left

MAN
81.62640.6051



Kabine / Cabin

63 450 696 WINDOW REGULATOR
right

MAN
81.62640.6052



28 869 008 WINDSHIELD WASHER PUMP

F 2000

MAN 81.26485.6008 **VDO** 246.075-010-001C

Mercedes Benz
000 869 24 21



28 869 033 WINDSHIELD WASHER PUMP

TGA TGS TGX

MAN
81.26485.6033



28 869 221 WINDSHIELD WASHER PUMP

MAN 81.26485.6016 **Scania** 295970

Mercedes Benz 000 860 32 26 **VW** 690 955 651



Kabine / Cabin

28 869 321 WINDSHIELD WASHER PUMP

F 2000

MAN
81.26485.6027



26 430 080 WIPER ARM

MAN
81.26430.0080



28 820 006 WIPER ARM

MAN
81.26430.6057



28 820 007 WIPER ARM

MAN
81.26430.6059

SWF
109.867



Kabine / Cabin

28 820 008 WIPER ARM

MAN
81.26430.6058

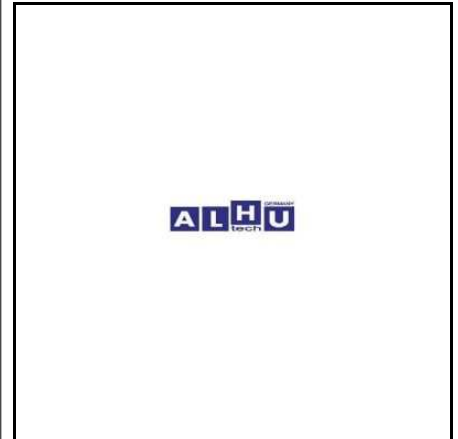

28 820 083 WIPER ARM

MAN
81.26430.0083

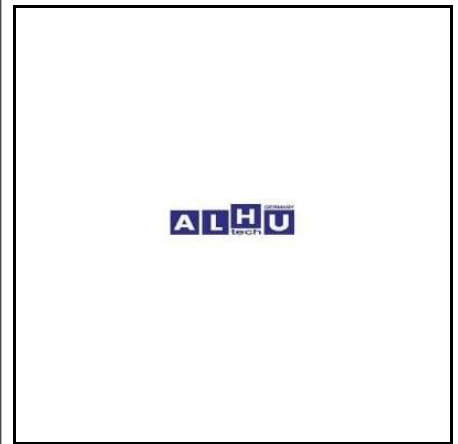

63 450 666 WIPER ARM

MAN
81.26430.0081

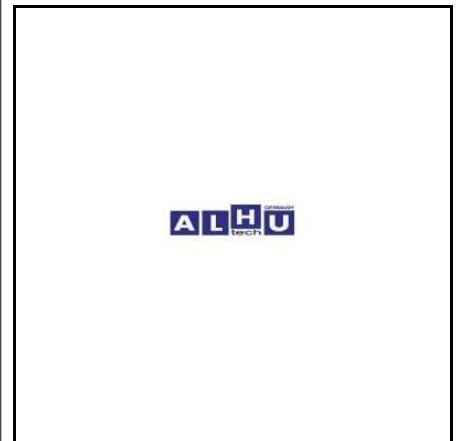

63 450 246 WIPER BEARING

MAN
81.26421.6042

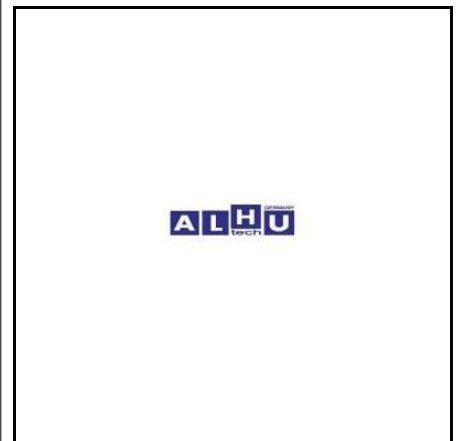

Kabine / Cabin

28 264 113 WIPER LINKAGE

MAN
81.26411.6113



28 820 009 WIPER LINKAGE

MAN
81.26411.6092



28 820 011 WIPER LINKAGE

TGA TGX

MAN
81.26411.6112



28 820 089 WIPER LINKAGE

left

MAN
81.26411.6089



Kabine / Cabin

28 820 090	WIPER LINKAGE
	right
MAN	
81.26411.6090	

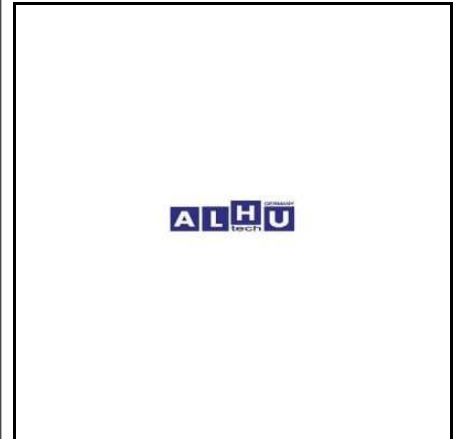

28 820 091	WIPER LINKAGE
	F 2000
MAN	
81.26411.6091	

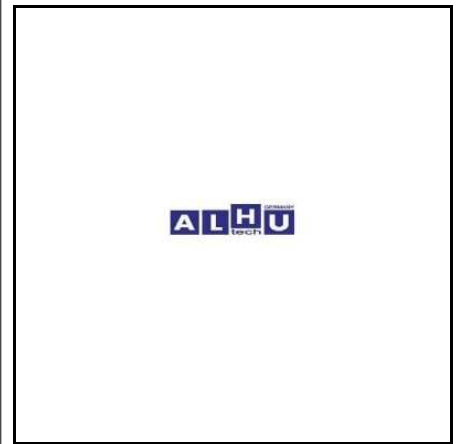

28 820 111	WIPER LINKAGE
	TGA
MAN	
81.26411.6111	

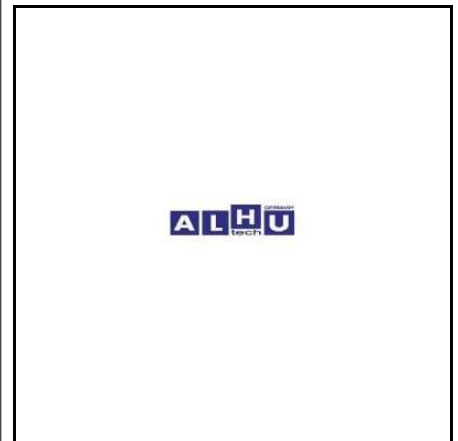

28 820 001	WIPER MOTOR
MAN	
81.26401.6051	

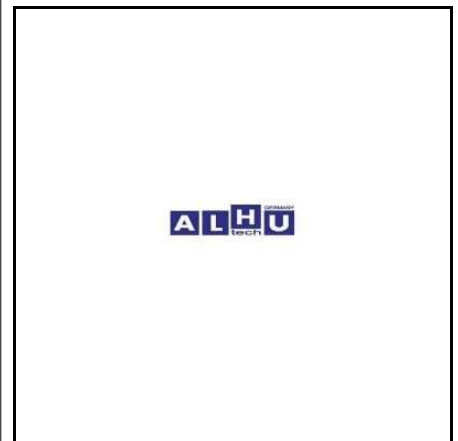

Kabine / Cabin

28 820 002 WIPER MOTOR

MAN
81.26401.6118

SWF
404.027



28 820 003 WIPER MOTOR

MAN
81.26401.6127

SWF
404067



28 820 004 WIPER MOTOR

MAN
81.26401.6137



28 820 005 WIPER MOTOR

TGA TGS TGX

MAN
81.26401.6141

SWF
405.001



Kabine / Cabin

28 820 142 WIPER MOTOR

F 2000

MAN
81.26401.6119

SWF
403.947

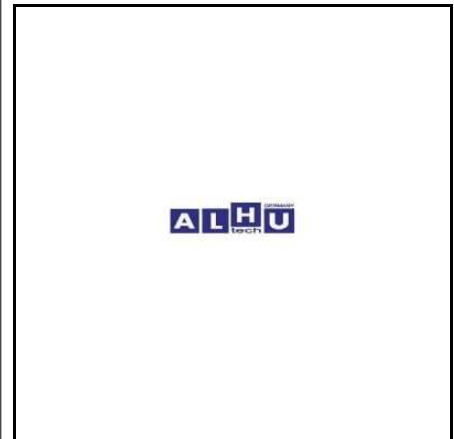

63 451 654 WIPER MOTOR



MAN
81.26401.6087

Mercedes Benz
002 820 40 42

Bosch
0 390 442 401

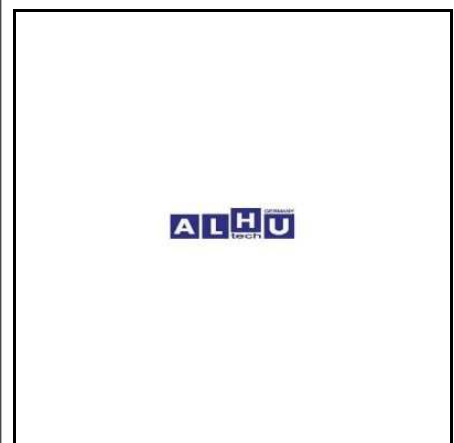

26 421 066 WIPER PIVOT-SHAFT

MAN
81.26421.0066

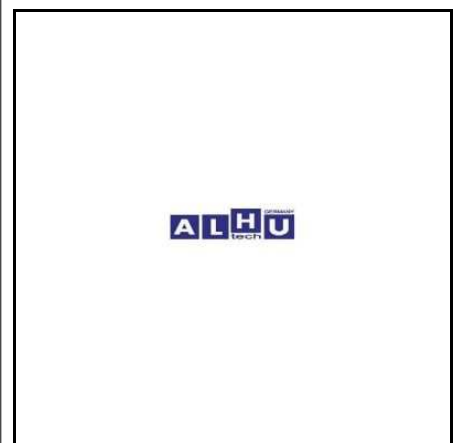

26 421 067 WIPER PIVOT-SHAFT

MAN
81.26421.0067

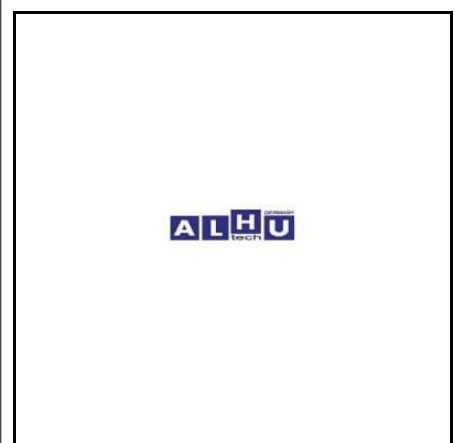

Lenkung / Steering

23 460 204 BALL JOINT

TGA TGS TGX

MAN
81.95301.6204

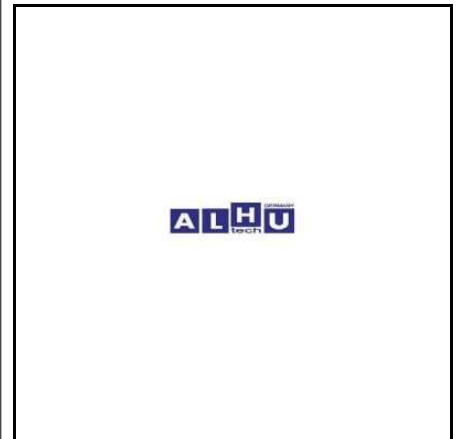

63 450 131 BALL JOINT

MAN
81.95301.6288

Mercedes Benz
000 460 52 48

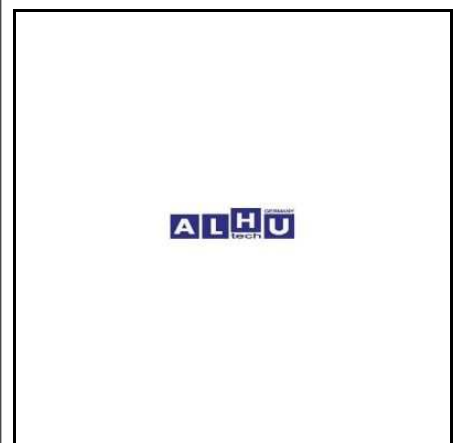

63 450 197 BALL JOINT

F 90

MAN
81.95301.6248

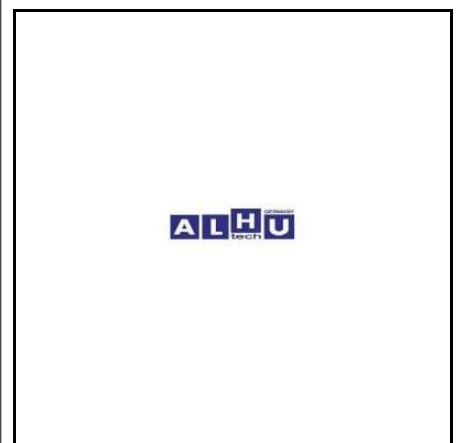

63 450 455 BALL JOINT

MAN
81.95301.0040

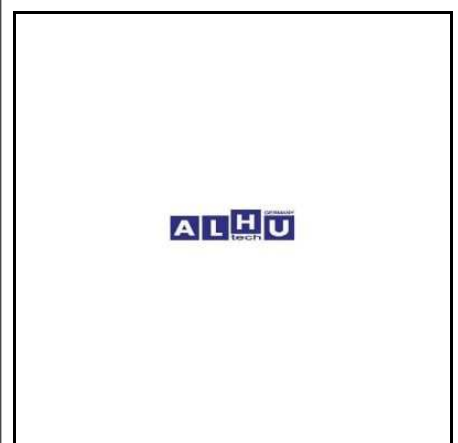

Lenkung / Steering

63 450 456 BALL JOINT

MAN
81.95301.6263



63 450 457 BALL JOINT

MAN
81.95301.6286

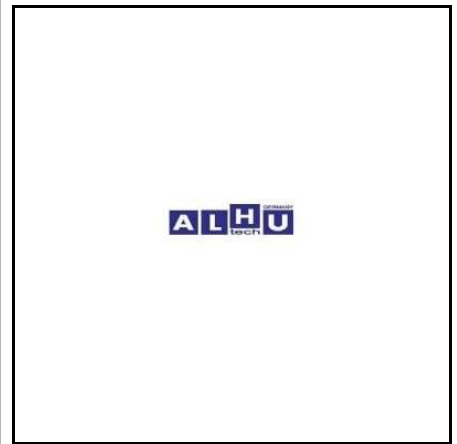

63 450 459 BALL JOINT

MAN
81.95301.6321

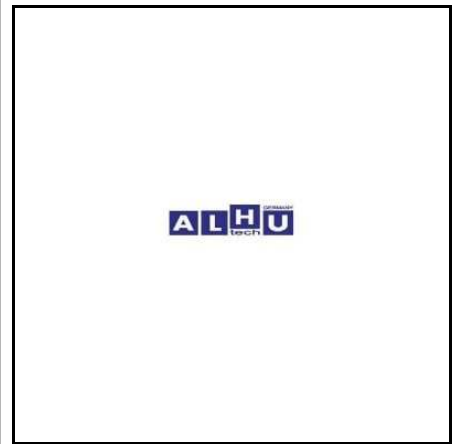

63 450 460 BALL JOINT

MAN
81.95301.6322

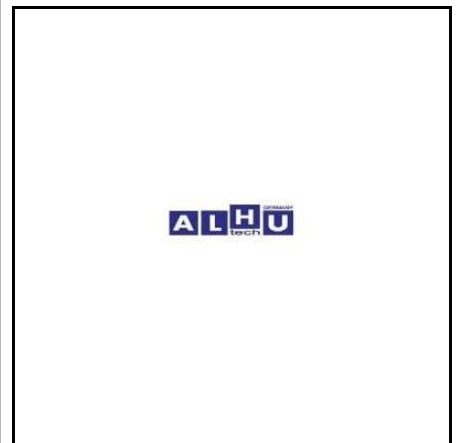

Lenkung / Steering

63 450 815 BALL JOINT

MAN
81.95301.6291



23 350 115 CONTROL ARM

MAN
81.43220.6275



63 450 442 CONTROL ARM

MAN
81.43220.6174



63 450 443 CONTROL ARM

MAN
81.43250.6007

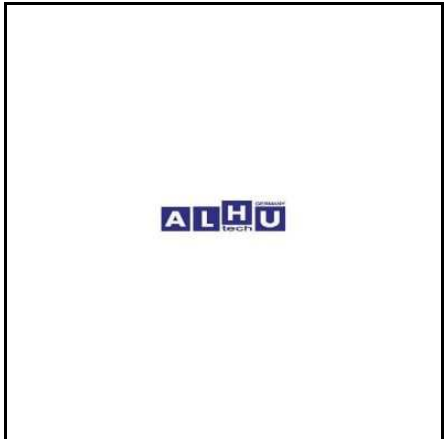

Lenkung / Steering

63 453 056 CONTROL ARM

MAN
81.43270.6097

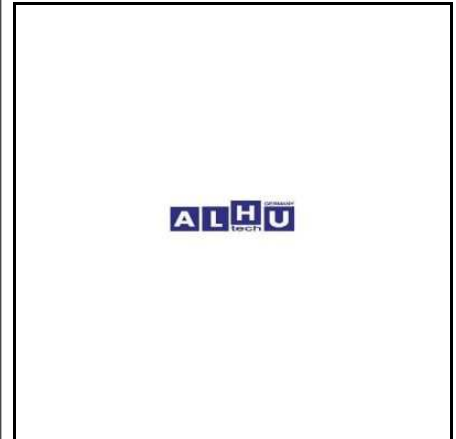

21 466 068 COVER
black

MAN
81.47302.0011

Mercedes Benz
000 466 06 68



24 460 653 DRAG LINK

MAN
81.46611.6061

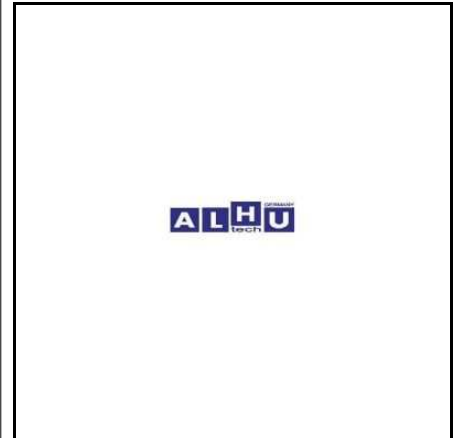

24 460 133 DRAG LINK

MAN
81.46611.6197

LMI
2571701



Lenkung / Steering

24 460 648 DRAG LINK

MAN
81.46610.6648

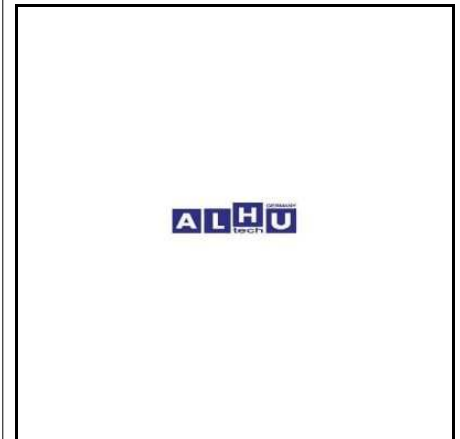

24 460 652 DRAG LINK

MAN
81.46611.6067

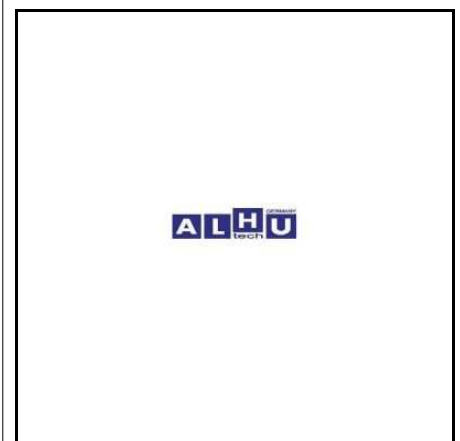

24 460 654 DRAG LINK

MAN
81.46711.6778

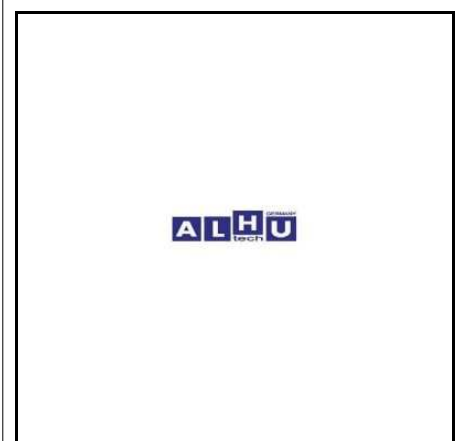

24 460 722 DRAG LINK

MAN
81.46610.6722

LMI
1176601

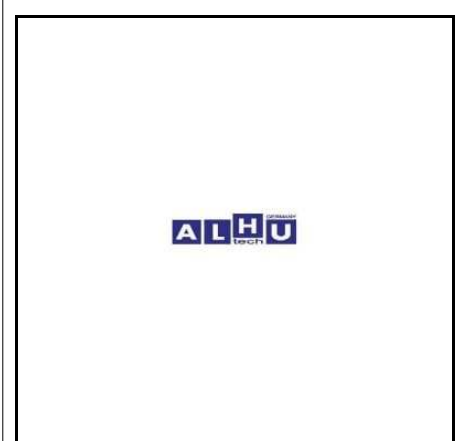

Lenkung / Steering

24 460 779 DRAG LINK

MAN
81.46610.6779



27 467 762 DRAG LINK

MAN
81.46711.6762



63 450 248 DRAG LINK

MAN
81.46611.6016



63 450 444 DRAG LINK

MAN
81.46610.6288



Lenkung / Steering

63 450 445 DRAG LINK

MAN
81.46611.6006



63 450 446 DRAG LINK

MAN
81.46611.6019



63 450 447 DRAG LINK

MAN
81.46611.6150



63 450 448 DRAG LINK

MAN
81.46611.6201



Lenkung / Steering

63 450 461 DRAG LINK

MAN
82.46610.6184

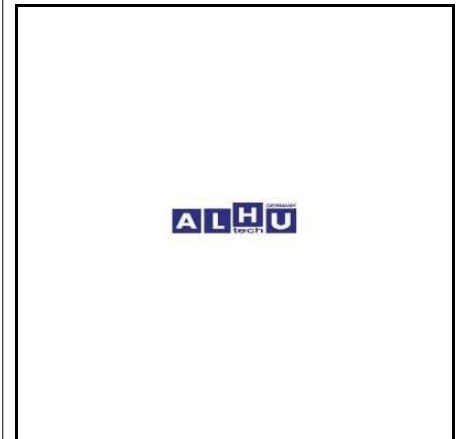

63 450 462 DRAG LINK

MAN
85.46610.6102

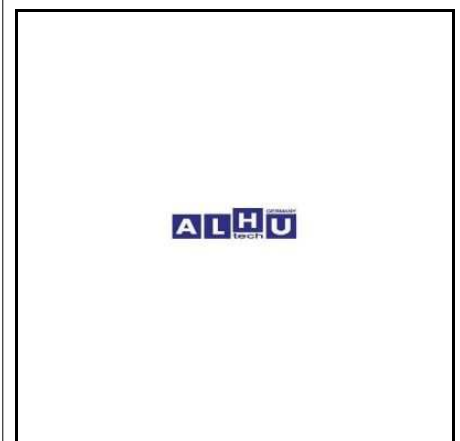

63 450 463 DRAG LINK

MAN
85.46610.6104

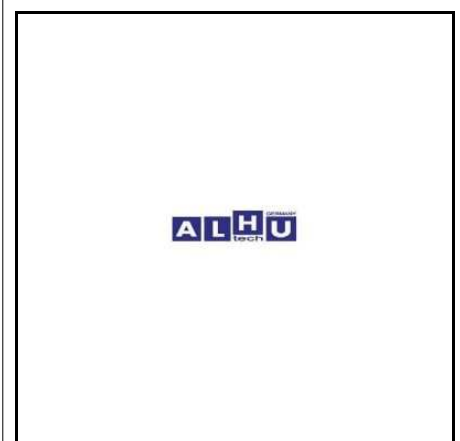

63 450 464 DRAG LINK

MAN
85.46610.6140

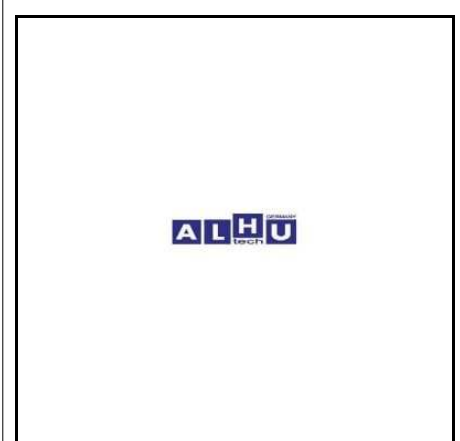

Lenkung / Steering

63 450 465 DRAG LINK

MAN
85.46610.6163



63 450 466 DRAG LINK

MAN
85.46610.6244



63 450 467 DRAG LINK

MAN
85.46610.6246



63 450 468 DRAG LINK

MAN
85.46610.6247



Lenkung / Steering

28 618 510 JOINT BEARING

MAN
06.36950.0510

ZF
0635 285 061

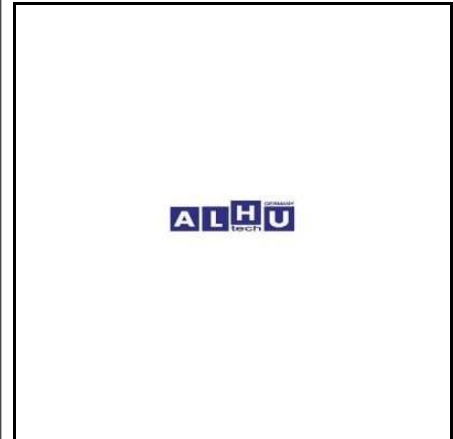

21 466 267 OIL DIPSTICK

MAN
81.47303.0045

Mercedes Benz
000 466 08 67



**21 460 047 OIL RESERVOIR
STEERING PUMP**

MAN
81.47301.6047

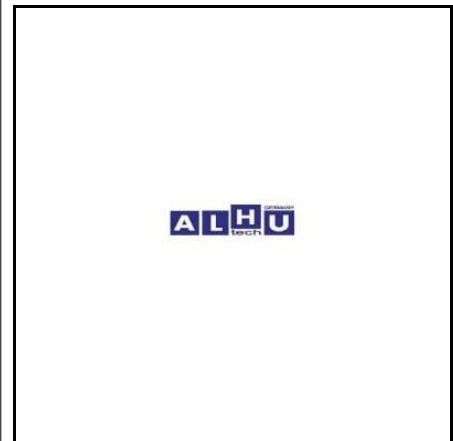

**21 460 502 OIL RESERVOIR
STEERING PUMP**

MAN
81.47301.6030

Mercedes Benz
000 466 45 02



Lenkung / Steering

27 000 000	OIL RESERVOIR
	STEERING PUMP
<p>MAN 81.47301.6048</p>	



63 450 142	STEERING BUSHING
<p>MAN 81.46109.0038</p>	



24 460 009	STEERING LOCK
<p>MAN 81.46433.6009</p>	



24 460 013	STEERING LOCK
	with 3 keys
<p>MAN 81.46433.6013</p>	



Lenkung / Steering

21 460 136 STEERING PUMP	
	TGA TGS TGX
MAN 81.47101.6136	
ZF 7685 955 125	



21 460 137 STEERING PUMP	
	TGA TGS TGX
MAN 81.47101.6137	
ZF 7685 955 324	



21 460 189 STEERING PUMP	
	F 90
MAN 81.47101.6189	
ZF 7685 955 152	



24 461 112 STEERING SHAFT	
	F 2000
MAN 81.46122.6112	

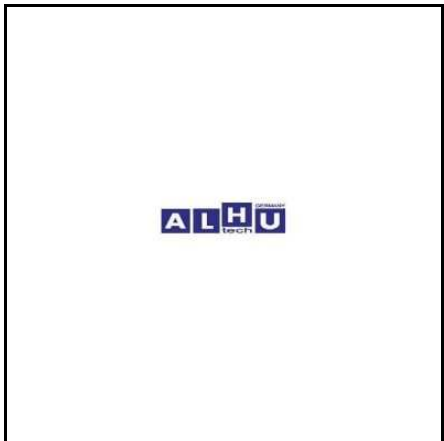

Lenkung / Steering

27 113 042 STEERING SPINDLE

MAN
81.46113.6042

ZF
7360 429 161



24 460 069 STEERING WHEEL
with signal cap and 3 keys

F 2000

MAN
81.46430.0069



24 460 725 TIE ROD

F 2000

MAN
81.46711.6725
81.46711.6820



63 450 160 TIE ROD

MAN
81.46711.6921

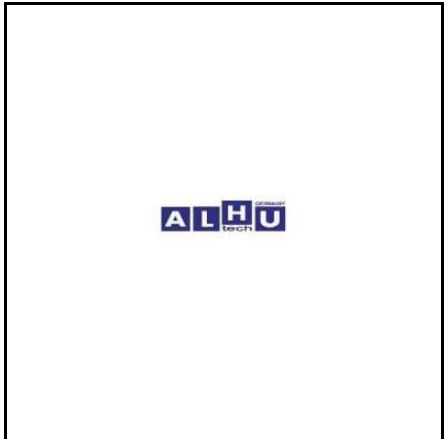

Lenkung / Steering

63 450 449 TIE ROD

MAN
81.46710.6372

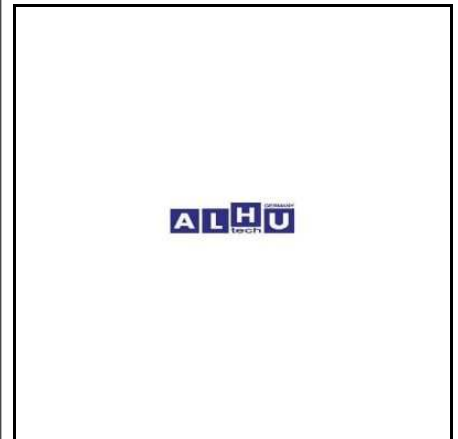

63 450 450 TIE ROD

MAN
81.46711.6712

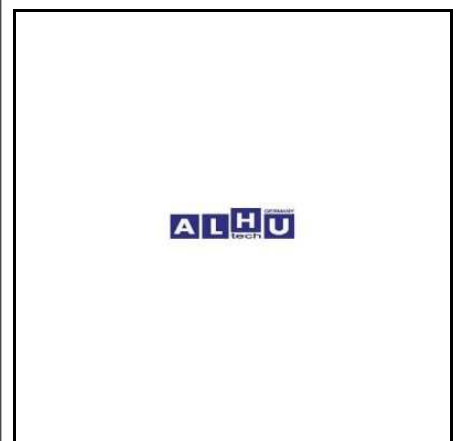

63 450 451 TIE ROD

MAN
81.46711.6715

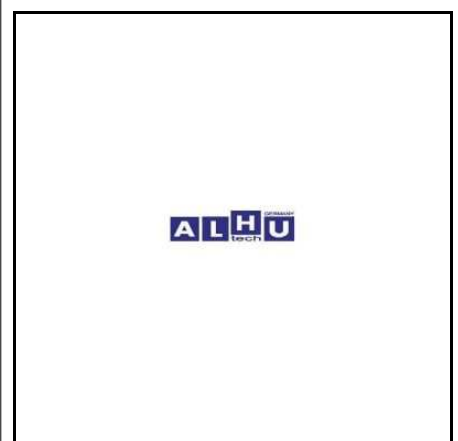

63 450 452 TIE ROD

MAN
81.46711.6728

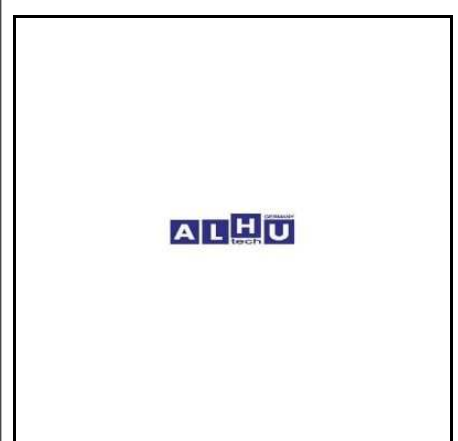

Lenkung / Steering

63 450 453 TIE ROD

MAN
81.46711.6729



63 450 454 TIE ROD

MAN
81.46711.6759



23 330 035 TIE ROD END

MAN 81.95301.6239 81.95301.6272	Mercedes Benz 001 330 01 35
DAF 1229944	LMI 1140202



23 460 202 TIE ROD END

F 2000

MAN
81.95301.6202



Lenkung / Steering

23 460 248 TIE ROD END	
RH	
MAN 81.95301.6234 81.95301.6274 81.95301.6308	LMI 1150503
Mercedes Benz 001 460 22 48	Scania 1358793



23 460 448 TIE ROD END	
LH	
MAN 81.95301.6309 81.95301.6351	Mercedes Benz 001 460 14 48
DAF 690225	Iveco 4802444
weitere/another	



63 450 688 UNIVERSAL JOINT	
MAN 81.46105.6015	

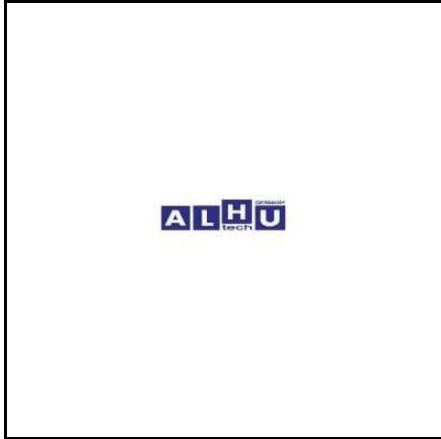

Motor / Engine

21 470 007 AIR CLEANER

MAN
51.08301.0016



21 072 112 AIR CYLINDER

MAN
81.11701.6046

KNORR
I58893

Mercedes Benz
000 072 01 12



21 140 455 AIR CYLINDER

MAN
81.15701.6120



21 140 457 AIR CYLINDER

MAN
81.15701.6079



Motor / Engine

21 140 458 AIR CYLINDER

MAN
81.15701.6093

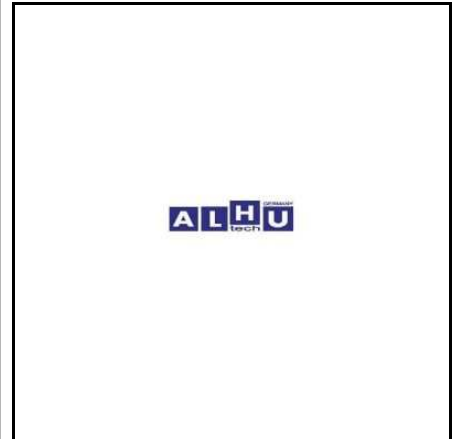

21 140 460 AIR CYLINDER

MAN
81.15701.6112



21 430 826 AIR CYLINDER

MAN
88.15701.6003

KNORR
I90948

Mercedes Benz
000 430 49 26



63 450 658 AIR CYLINDER

MAN
81.15701.6119

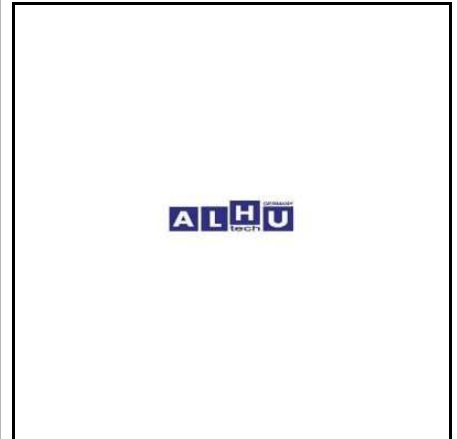

Motor / Engine

63 450 659 AIR CYLINDER

MAN
81.15701.6124

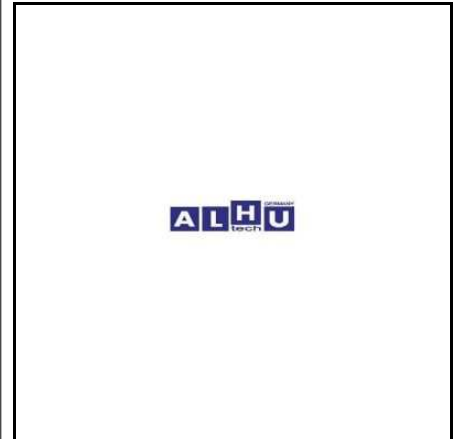

63 450 589 BALL SOCKET

MAN
06.36099.0002

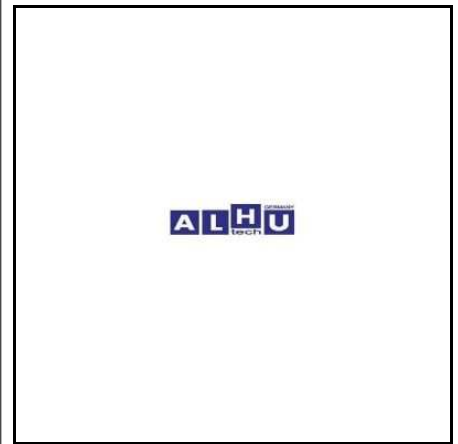

21 098 118 BELLOW

D 2866 D 2876

MAN
51.09402.0118

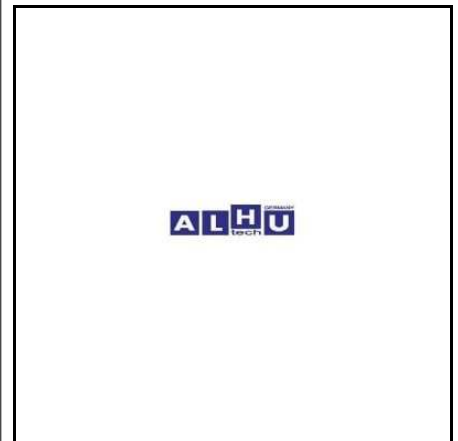

21 098 188 BELLOW

MAN
51.09402.0188

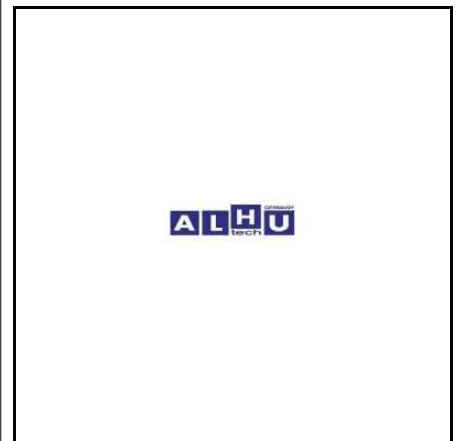

Motor / Engine

21 098 242	BELLOW
<p>MAN 81.96420.0242</p>	



21 528 519	BELLOW
	air intake
<p>MAN 81.96420.0519</p>	



28 420 000	BELLOW
	air intake
<p>MAN 81.96420.0118</p>	



21 200 088	BELT TENSIONER
	D 2866 D 2876
<p>MAN 51.95800.7396</p>	
<p>TA501 T5014</p>	



Motor / Engine

21 200 089 BELT TENSIONER

D 0834 D 0836

MAN
51.95800.7437

TA501
APV1128



21 200 104 BELT TENSIONER

D 2866 D 2876

MAN
51.95800.7397

TA501
T 5018



21 200 435 BELT TENSIONER

D 2866 D 2876

MAN
51.95800.7435
51.95800.7480

TA501
APV1126



21 200 459 BELT TENSIONER

D 2076 D 2876

MAN
51.95800.7459

TA501
APV1134



Motor / Engine

21 200 580 BELT TENSIONER

D 2866 D 2876

MAN
51.95800.7315

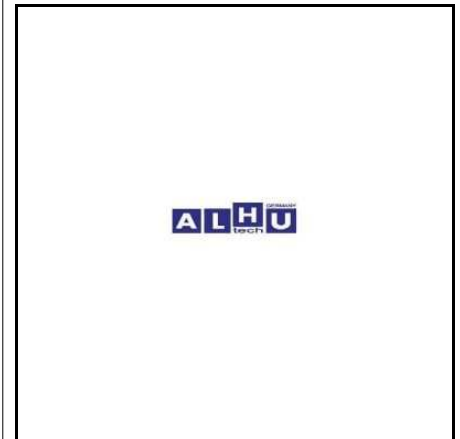

63 450 247 BELT TENSIONER

D 2566 D 2866

MAN
51.95800.7088

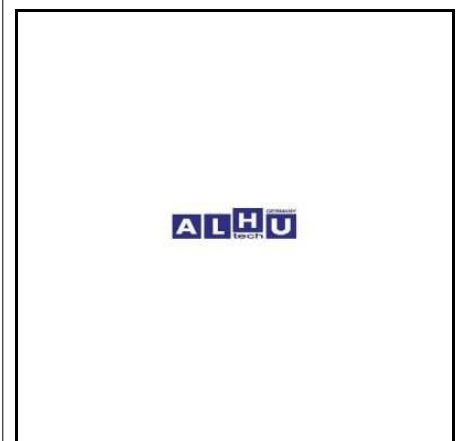

63 450 642 BELT TENSIONER

MAN
51.95800.7466

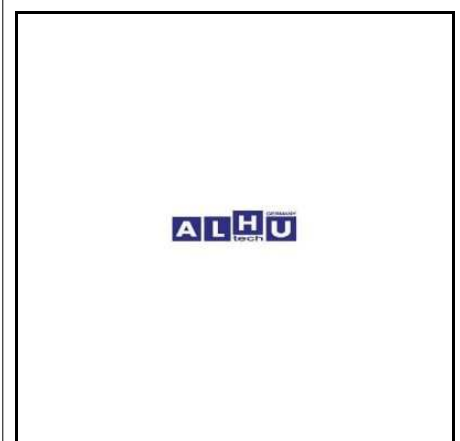

21 200 075 BELT TENSIONER PULLEY

MAN
51.95800.6075
51.95800.6107



Motor / Engine

21 200 076 BELT TENSIONER PULLEY

TGA

MAN
51.95800.6092
51.95800.6099



21 200 431 BELT TENSIONER PULLEY

D 2866 D 2876

MAN
51.95800.7431



63 450 643 BELT TENSIONER PULLEY

MAN
51.95801.6018

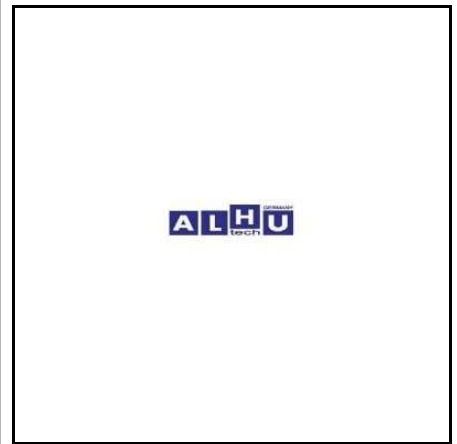

63 450 645 BELT TENSIONER PULLEY

MAN
51.95801.6019

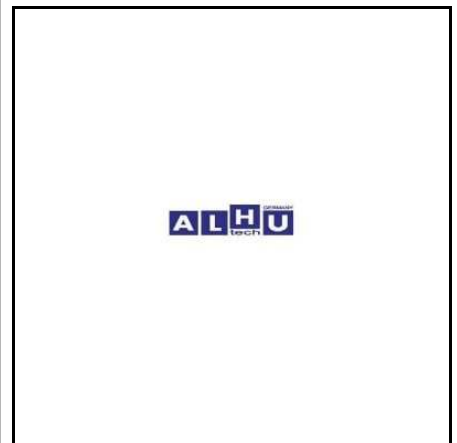

Motor / Engine

63 450 646 BELT TENSIONER PULLEY ARM

MAN
51.95840.0172



21 070 009 BOOSTER CYLINDER

MAN
51.11160.6009

Mercedes Benz
000 072 29 12

Bosch
0 482 020 003



21 300 159 BOWDEN CABLE

M 2000

MAN
81.95501.6481



21 300 261 BOWDEN CABLE

M 2000

MAN
81.95501.6261



Motor / Engine

21 300 359 BOWDEN CABLE

MAN
81.95501.6487



21 300 367 BOWDEN CABLE

MAN
81.95501.6367

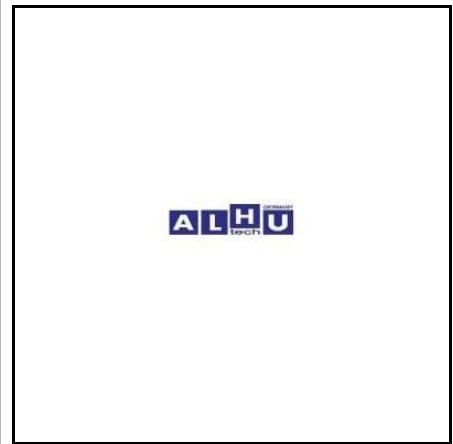

21 300 459 BOWDEN CABLE
2165 mm
F 2000

MAN
81.95501.6459

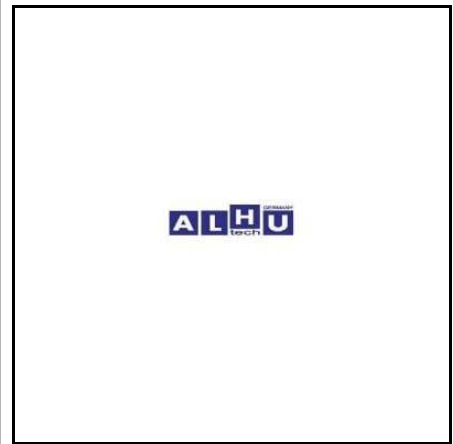

21 300 537 BOWDEN CABLE
TGA TGX

MAN
81.95501.6537

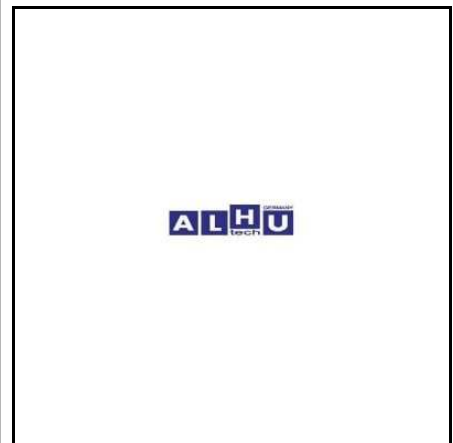

Motor / Engine

63 453 015 BOWDEN CABLE



MAN
81.95501.6451



63 450 846 BREATHER HOSE

Mercedes Benz
403 134 04 82



21 203 524 BREATHER TUBE

MAN
51.06302.5524



21 030 001 CAMSHAFT

MAN
51.04401.5053

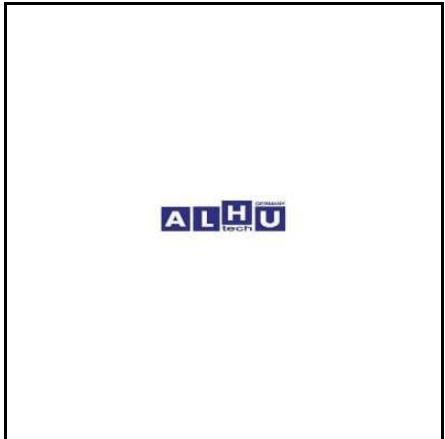

Motor / Engine

21 030 101	CAMSHAFT
<p>MAN 51.04400.6006</p>	

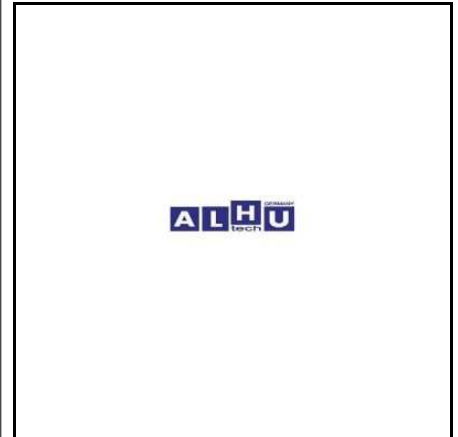

21 050 001	CAMSHAFT
<p>MAN 51.04401.6290</p>	

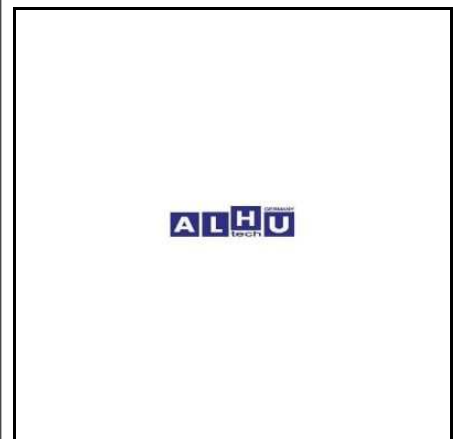

21 050 002	CAMSHAFT
<p>MAN 51.04401.6373</p>	

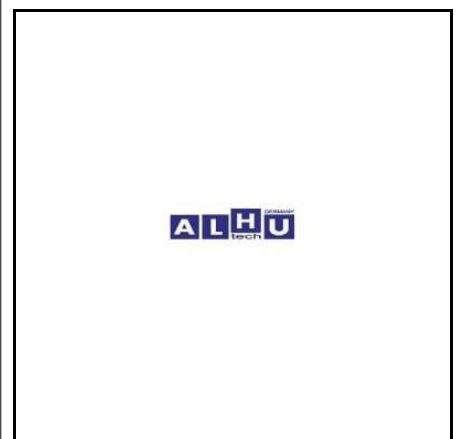

21 050 003	CAMSHAFT
<p>MAN 51.04401.6375</p>	

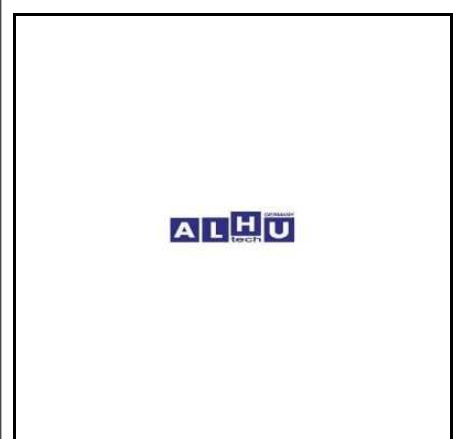

Motor / Engine

21 050 004 CAMSHAFT

MAN
51.04401.6148

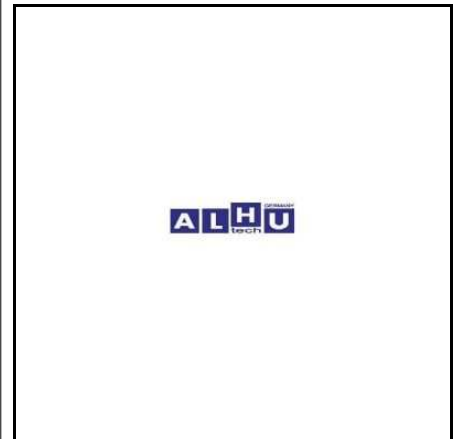

21 050 011 CAMSHAFT

MAN
51.04401.6371

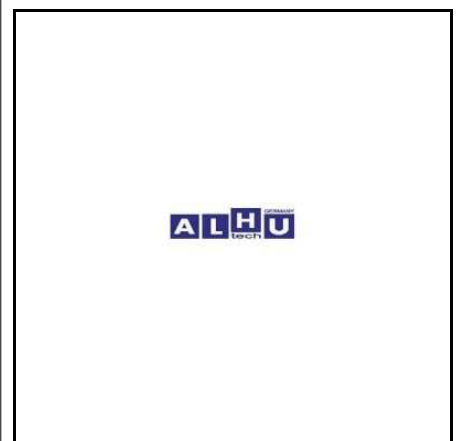

21 050 101 CAMSHAFT

MAN
51.04401.6266

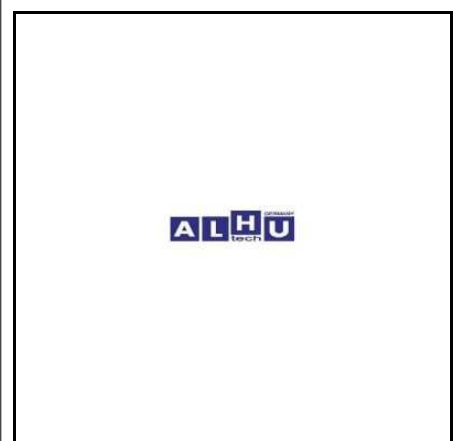

21 050 111 CAMSHAFT

MAN
51.04401.6398

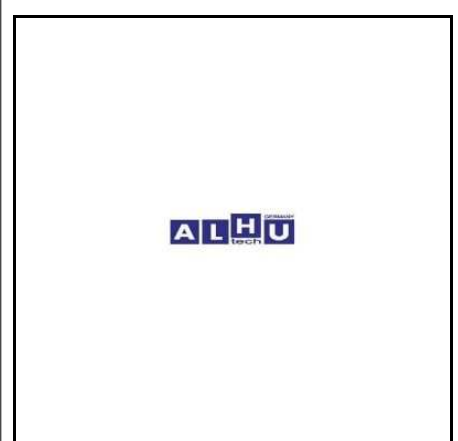

Motor / Engine

21 050 211	CAMSHAFT
<p>MAN 51.04401.6382</p>	

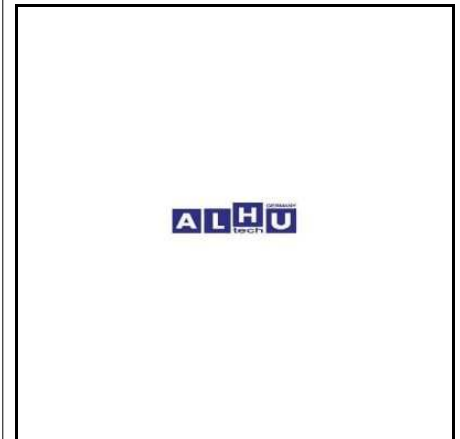

63 450 598	CAMSHAFT GEAR
<p>MAN 51.04501.0144</p>	

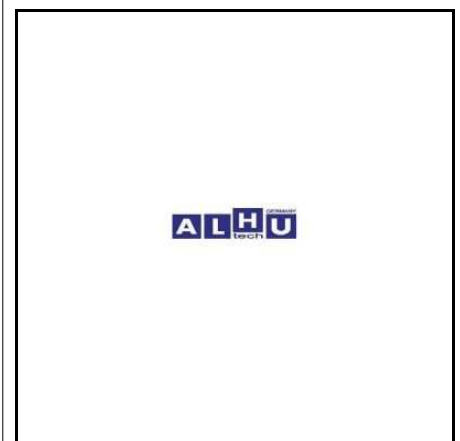

63 450 599	CAMSHAFT GEAR
<p>MAN 51.04505.0108</p>	

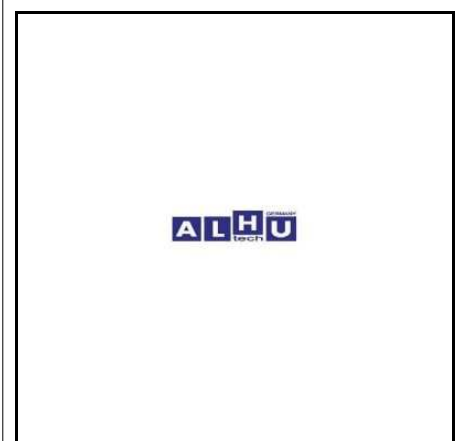

63 450 600	CAMSHAFT GEAR
<p>MAN 51.04505.5061</p>	

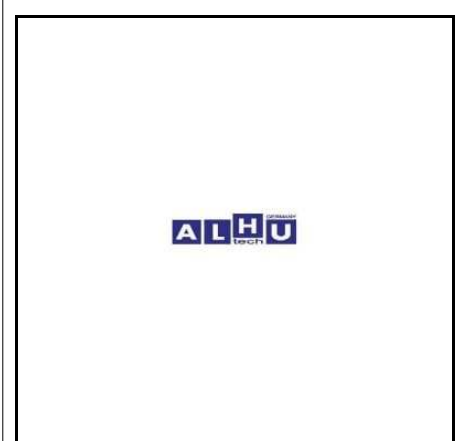

Motor / Engine

21 203 023 CLAMP INJECTION LINE

MAN
51.97401.6064



21 203 024 CLAMP INJECTION LINE

MAN
51.97401.6065



21 203 025 CLAMP INJECTION LINE

MAN
51.97401.6066



21 203 026 COMPRESSOR HOSE

MAN
51.10302.6025

Mercedes Benz
002 997 92 82



Motor / Engine

21 030 120	CONROD
D 2566/2866 and OM	
<p>MAN 51.02401.6214</p> <p>Mercedes Benz 407 030 07 20</p>	



21 030 221	CONROD
<p>MAN 51.02400.6049</p>	

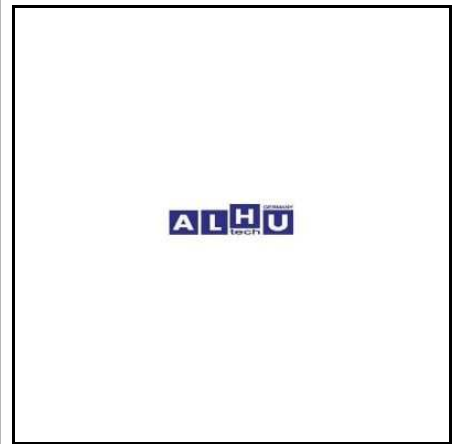

21 030 421	CONROD
<p>MAN 51.02400.6054</p>	

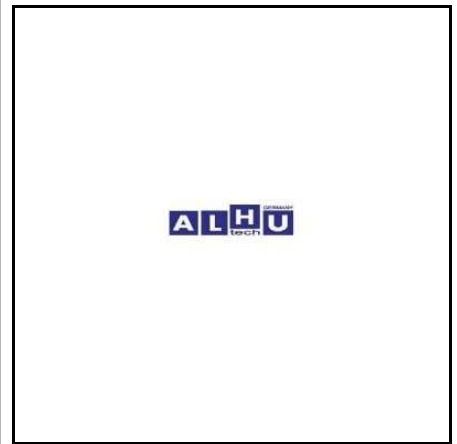

21 030 520	CONROD
<p>MAN 51.02401.6234</p>	

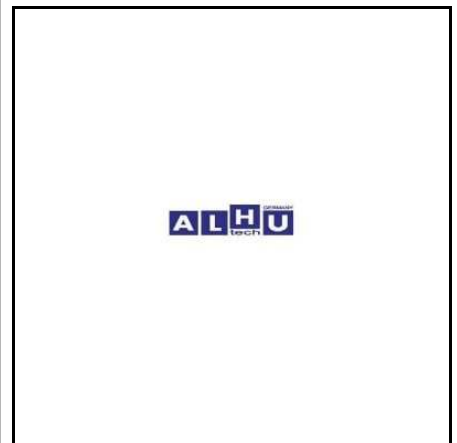

Motor / Engine

21 030 621 CONROD

MAN
51.02400.6066

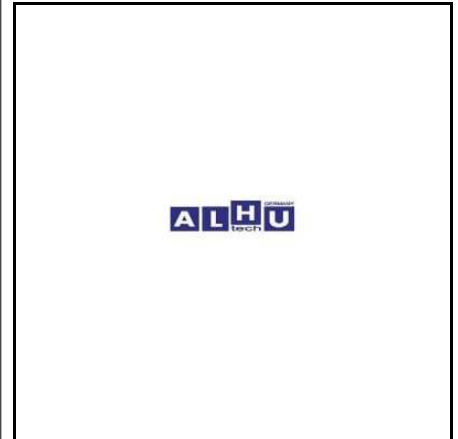

21 031 020 CONROD
complete with conrod bush

MAN
51.02400.6044

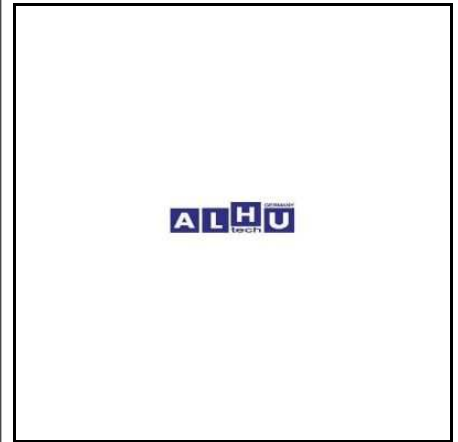

21 031 120 CONROD

MAN
51.02400.6023



21 031 420 CONROD

MAN
51.02400.6015



Motor / Engine

63 453 052 CONROD SCREW

 D 2066/2676

MAN
51.90490.0079



63 450 614 COOLANT ELBOW

MAN
51.06301.5725



63 450 615 COOLANT ELBOW

MAN
51.06302.0259



21 203 008 COOLING WATER LINE

MAN
51.06303.5351



Motor / Engine

21 203 115 COOLING WATER LINE

MAN
51.06302.5115

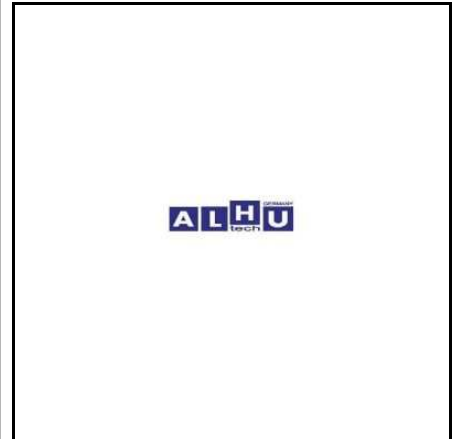

21 203 680 COOLING WATER PIPE

MAN
51.06301.5680



63 450 613 COOLING WATER PIPE

MAN
51.06301.0950



21 184 002 COVER

MAN
51.05505.6002

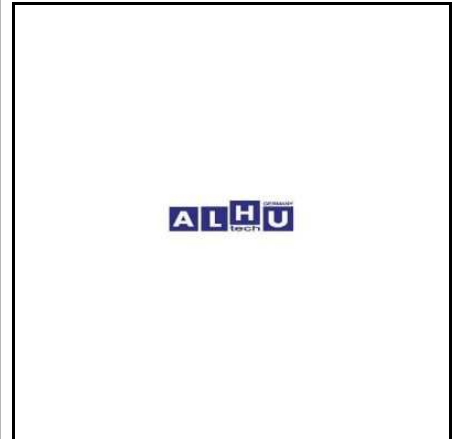

Motor / Engine

28 505 011 COVER, OIL FILTER

MAN
51.05505.0011



21 030 019 CRANKSHAFT

D 2566 D 2866

MAN
51.02100.6019



21 030 201 CRANKSHAFT

MAN
51.02101.6088



21 030 301 CRANKSHAFT

MAN
51.02100.6025



Motor / Engine

21 030 401 CRANKSHAFT

MAN
51.02101.6097



21 030 501 CRANKSHAFT

MAN
51.02101.6090



21 031 127 CRANKSHAFT RACE

MAN
51.02130.0032



21 032 309 CRANKSHAFT RACE

MAN
51.02130.0013

Mercedes Benz
403 032 03 09



Motor / Engine

21 010 020 CYLINDER HEAD

D 2876 LOH 02

MAN
51.03100.6053



21 010 120 CYLINDER HEAD

MAN
51.03101.6773



21 010 181 CYLINDER HEAD

MAN
51.03100.6181



21 010 220 CYLINDER HEAD

MAN
51.03101.6774



Motor / Engine

21 010 682 CYLINDER HEAD

D 0826

MAN
51.03101.6682



63 453 016 CYLINDER HEAD



D 2566 MT

MAN
51.03101.6510



21 010 381 CYLINDER HEAD SCREW

MAN
51.90020.0381



28 010 022 CYLINDER HEAD SCREW

MAN
51.90490.0022



Motor / Engine

28 010 023 CYLINDER HEAD SCREW

MAN
51.90490.0023



28 010 024 CYLINDER HEAD SCREW

MAN
51.90490.0024



21 997 448 DOUBLE SEAL RING

MAN
51.96501.0348



28 310 198 DRAIN PLUG

MAN
51.90310.0198



Motor / Engine

63 450 257 DRAIN PLUG

MAN
51.90310.0255



63 450 590 DRAIN PLUG

MAN
06.08049.0004



63 450 249 DRIVE GEAR

MAN
51.54210.0109



63 450 631 DRIVE GEAR

MAN
51.11301.0090



Motor / Engine

63 450 632	DRIVE GEAR
<p>MAN 51.11301.0159</p>	

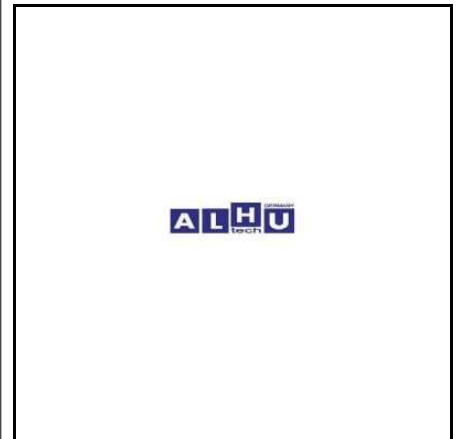

63 450 252	DRIVE SHAFT
<p>MAN 51.06650.0005</p>	

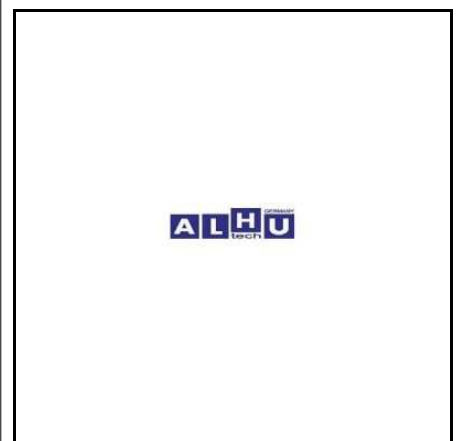

28 471 024	DRIVING DOG
<p>TGA TGS TGX</p>	
<p>MAN 51.47104.0024</p>	

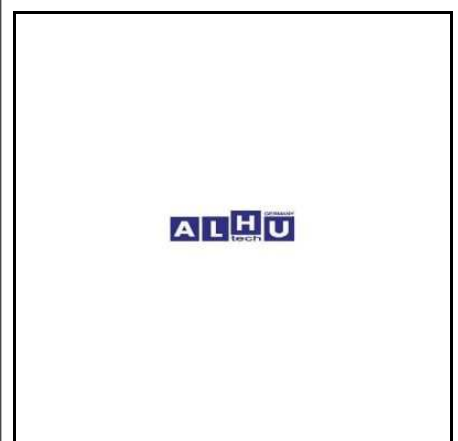

21 094 003	DRY AIR CLEANER
<p>complete with filter</p>	
<p>F 2000</p>	
<p>MAN 81.08400.6003</p>	

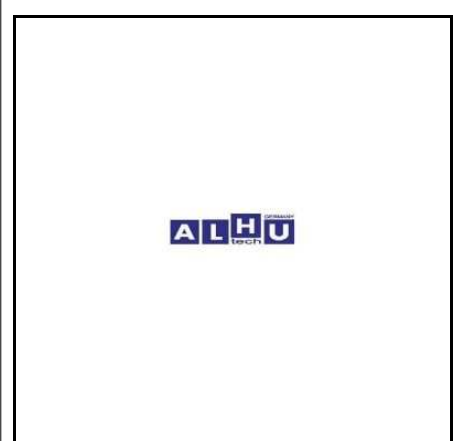

Motor / Engine**21 094 002 DRY AIR CLEANER**

MAN
81.08301.6281

**21 094 004 DRY AIR CLEANER**

MAN
81.08400.6004

**21 094 005 DRY AIR CLEANER**

MAN
81.08401.6169

**61 451 396 DRYER BOTTLE**

MAN
83.77953.6501



Motor / Engine

21 094 050 DUST EJECTOR VALVE

F 2000

MAN
81.08312.0010



21 241 235 ENGINE MOUNTING

MAN
81.96020.0235



21 241 340 ENGINE MOUNTING

MAN
81.96020.0340



21 241 341 ENGINE MOUNTING

MAN
81.96020.0341



Motor / Engine

21 241 382 ENGINE MOUNTING

MAN
81.96020.0382



21 241 384 ENGINE MOUNTING

MAN
81.96020.0384



21 241 386 ENGINE MOUNTING

MAN
81.96020.0386



21 241 402 ENGINE MOUNTING

MAN
81.96020.0402



Motor / Engine

21 241 403 ENGINE MOUNTING

MAN
81.96020.0403



28 210 366 ENGINE MOUNTING

MAN
81.96210.0366

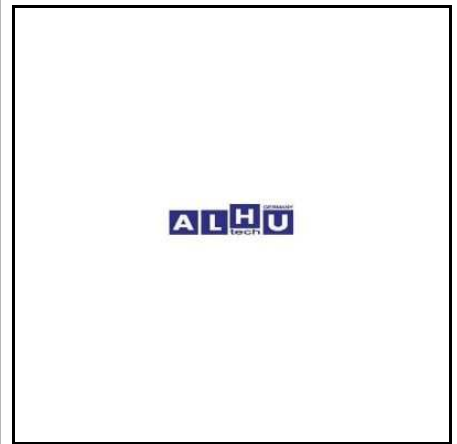

28 240 002 ENGINE MOUNTING

L 2000

MAN
81.41506.0096

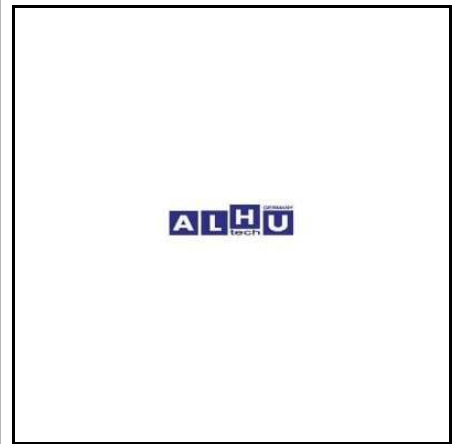

28 240 003 ENGINE MOUNTING
right

MAN
81.96210.0440

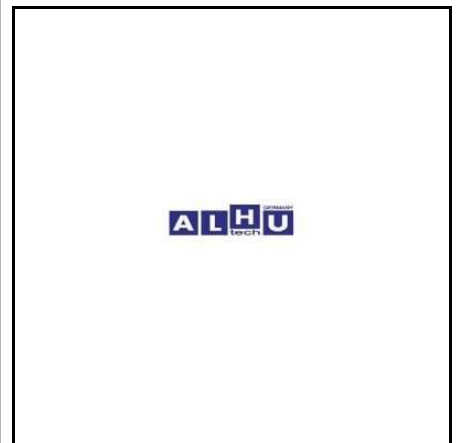

Motor / Engine

28 240 004 ENGINE MOUNTING
front
TGA

MAN
81.96210.0571



28 240 005 ENGINE MOUNTING
left

MAN
81.96210.0441



63 450 048 ENGINE MOUNTING

MAN
81.96210.0242



63 453 023 ENGINE MOUNTING

new

MAN
81.96210.0439

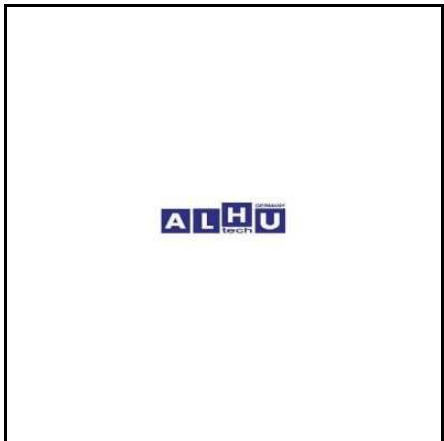

Motor / Engine

21 491 120 EXHAUST BRACKET

MAN
81.15502.5120



24 997 005 EXHAUST CLAMP

MAN
06.67049.0005



24 997 017 EXHAUST CLAMP

MAN
81.97420.2017



24 997 023 EXHAUST CLAMP

MAN
81.97420.0023



Motor / Engine

24 997 026 EXHAUST CLAMP

MAN
81.97420.0026



24 997 073 EXHAUST CLAMP

MAN
81.97420.0073

Mercedes Benz
071 555 11 05 01



24 997 085 EXHAUST CLAMP

MAN
81.97420.0085
81.97420.0139

Mercedes Benz
071 555 11 45 00



24 997 099 EXHAUST CLAMP

MAN
06.67042.0116
06.67049.0099

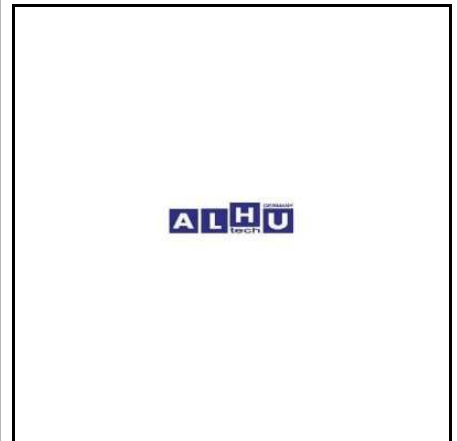

Motor / Engine

24 997 113 EXHAUST CLAMP

MAN
06.67042.0113



24 997 152 EXHAUST CLAMP

MAN
81.97420.0152



24 997 157 EXHAUST CLAMP

MAN
81.97420.0157



63 451 382 EXHAUST CLAMP

MAN
81.97420.5045

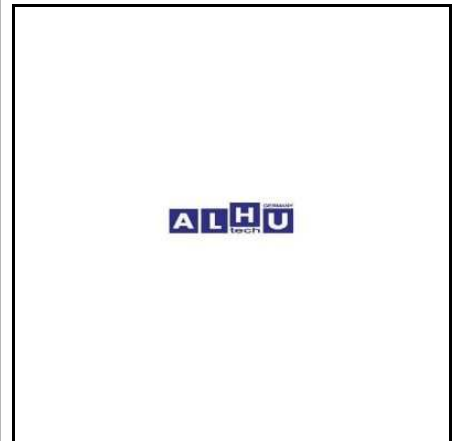

Motor / Engine

63 451 383 EXHAUST CLAMP

MAN
81.97460.6021



63 450 636 EXHAUST ELBOW

MAN
51.15201.6183



63 450 637 EXHAUST GASKET

MAN
51.15901.0012



63 451 122 EXHAUST GASKET

MAN
81.98701.0014



Motor / Engine

26 810 909 EXHAUST MANIFOLD

MAN
51.08101.0909



26 810 910 EXHAUST MANIFOLD

MAN
51.08101.0910



26 810 911 EXHAUST MANIFOLD

MAN
51.08101.0911



26 810 912 EXHAUST MANIFOLD

MAN
51.08101.0912



Motor / Engine

26 810 913 EXHAUST MANIFOLD

MAN
51.08101.0913



26 810 915 EXHAUST MANIFOLD

MAN
51.08101.0914



26 810 916 EXHAUST MANIFOLD

MAN
51.08102.0024



28 102 077 EXHAUST MANIFOLD

MAN
51.08102.0077



Motor / Engine

63 450 619 EXHAUST MANIFOLD

MAN
51.08101.0609



63 450 620 EXHAUST MANIFOLD

MAN
51.08101.0610



63 450 621 EXHAUST MANIFOLD

MAN
51.08101.0630



63 450 622 EXHAUST MANIFOLD

MAN
51.08101.0631



Motor / Engine

63 450 623 EXHAUST MANIFOLD

MAN
51.08101.0683



63 450 624 EXHAUST MANIFOLD

MAN
51.08101.0704



21 140 067 EXHAUST MANIFOLD BOLT

MAN
51.90001.0167



21 140 169 EXHAUST MANIFOLD BOLT

MAN
51.90001.0169



Motor / Engine

63 450 625 EXHAUST MANIFOLD GASKET

MAN
51.08901.0200



21 490 004 EXHAUST METAL HOSE

TGL TGM

MAN
81.15210.5004



21 490 008 EXHAUST METAL HOSE

TGX TGS EURO 5

MAN
81.15210.5008



21 490 017 EXHAUST METAL HOSE

MAN
81.15210.0017



Motor / Engine

21 490 022 EXHAUST METAL HOSE

MAN
81.15210.0022



21 490 033 EXHAUST METAL HOSE

MAN
81.15210.0033



21 490 054 EXHAUST METAL HOSE

F 2000

MAN
81.15210.0054



21 490 056 EXHAUST METAL HOSE

MAN
81.15210.0056

TA501
1533

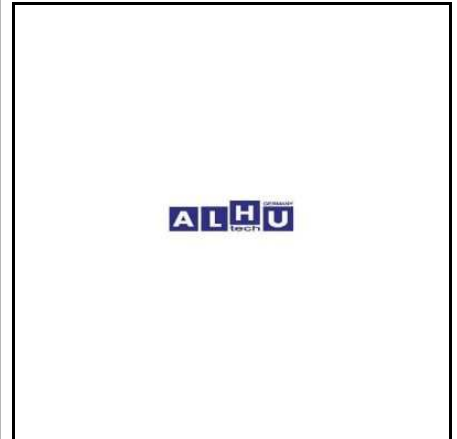

Motor / Engine

21 490 064 EXHAUST METAL HOSE

MAN
81.15210.0064



21 490 071 EXHAUST METAL HOSE

MAN
81.15210.0071



21 490 074 EXHAUST METAL HOSE

MAN
81.15210.0074



21 490 078 EXHAUST METAL HOSE

MAN
81.15210.0078

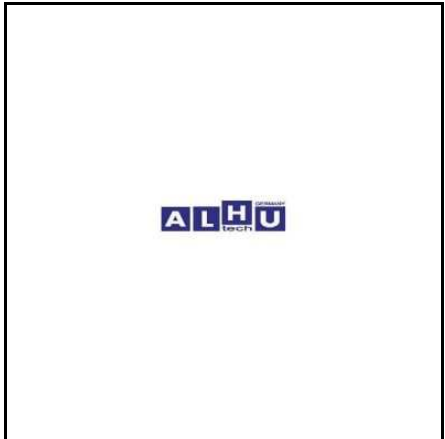

Motor / Engine

21 490 084 EXHAUST METAL HOSE

TGA TGS TGX

MAN
81.15210.0084



21 490 086 EXHAUST METAL HOSE

TGA TGS TGX

MAN
81.15210.0086

TA501
347238



21 499 390 EXHAUST METAL HOSE

MAN
81.15210.0049



21 500 153 EXHAUST MOUNTING

MAN
81.96210.0153

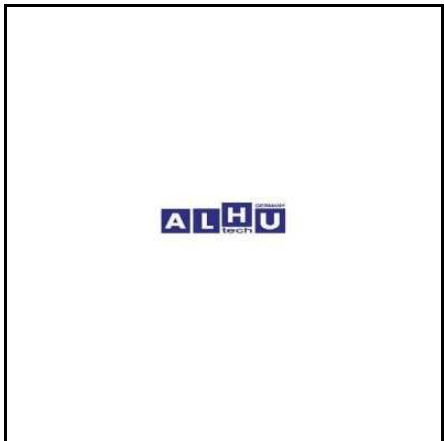

Motor / Engine

21 140 026 EXHAUST THROTTLE

MAN
81.15601.6057

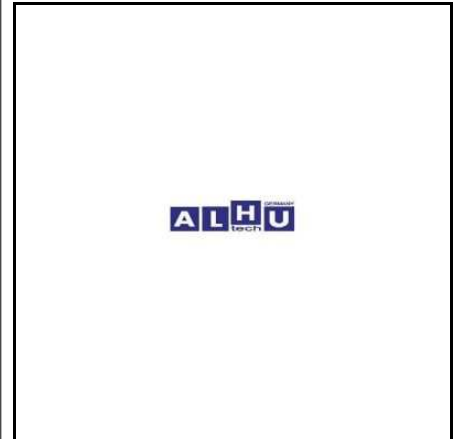

21 140 056 EXHAUST THROTTLE

MAN
81.15600.6081
81.15601.0022



21 140 076 EXHAUST THROTTLE

MAN
81.15600.6106

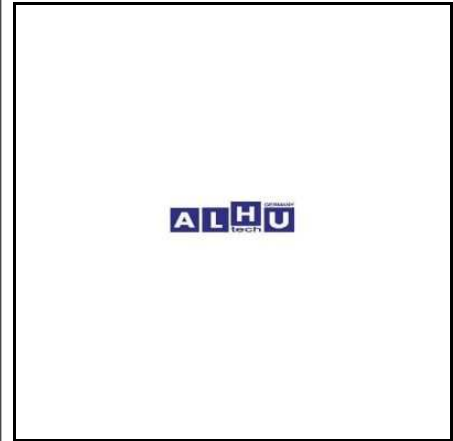

21 500 047 EXPANSION TANK

MAN
81.06102.6203

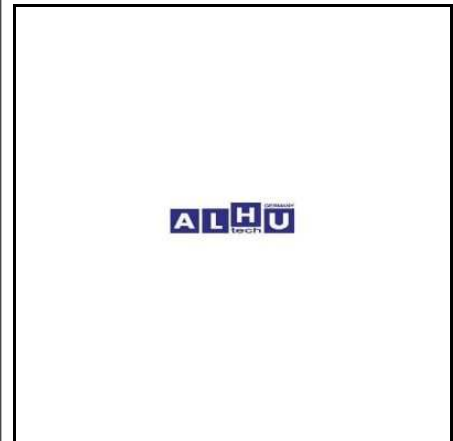

Motor / Engine

21 500 048 EXPANSION TANK

MAN
81.06102.6204



21 500 449 EXPANSION TANK

MAN
81.06102.6209



21 500 549 EXPANSION TANK

MAN
81.06102.6201
81.06102.6202
81.06102.6218

Behr/Hella
8MA 376 705-241



21 500 749 EXPANSION TANK

MAN
81.06102.6118



Motor / Engine

21 500 949 EXPANSION TANK

MAN
81.06102.6208

Behr/Hella
8MA 376 705-381



61 451 395 EXPANSION VALVE

MAN
81.61967.0010

Mercedes Benz
001 830 05 84

Behr/Hella
8UW 351 234-041



21 468 137 EYE BOLT

MAN
51.90441.0137



63 450 639 EYE BOLT

MAN
51.90441.0114



Motor / Engine

63 450 640 EYE BOLT

MAN
51.90441.0127

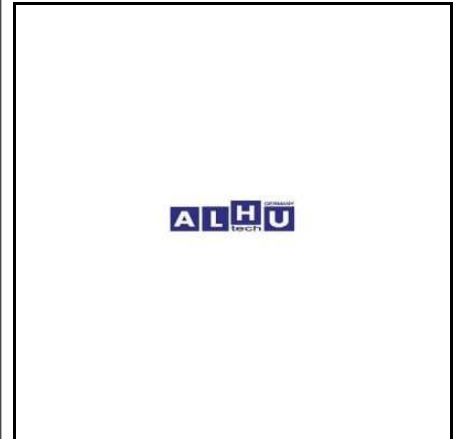

28 600 093 FAN BEARING

TGA

MAN
51.06600.6093

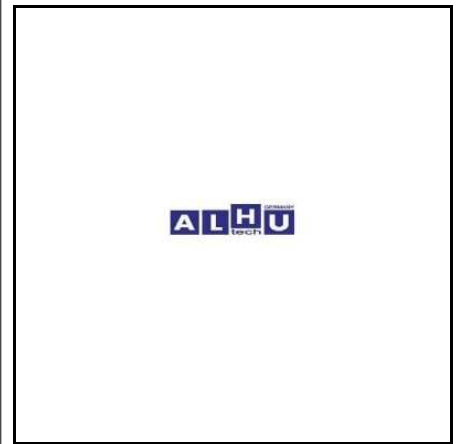

21 200 027 FAN BLADE

TGA

MAN
51.06601.0279

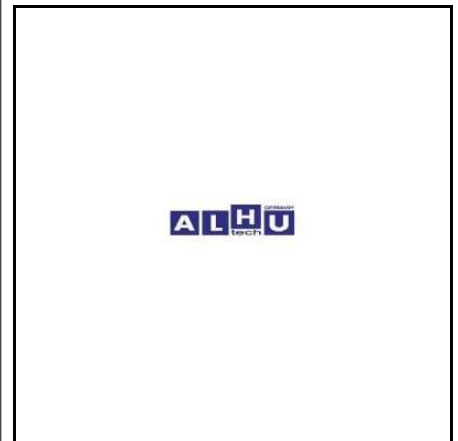

21 200 028 FAN BLADE

MAN
51.06601.0250

Behr/Hella
8MV 376 733-131

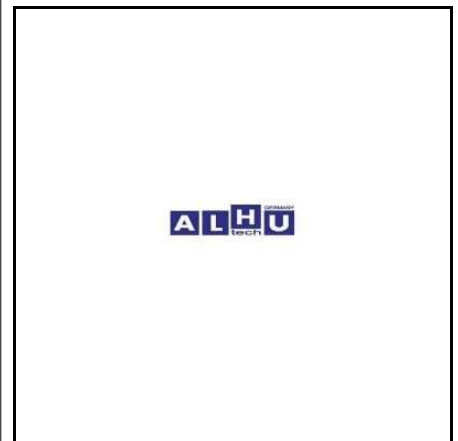

Motor / Engine

21 200 032 FAN BLADE

MAN
51.06601.0233



21 200 258 FAN BLADE

TGA

MAN
51.06601.0258



21 200 268 FAN BLADE

TGA

MAN
51.06601.0268



21 205 002 FAN BLADE

MAN
51.06601.0263

ZF Trading GmbH
2166 010 000



Motor / Engine

21 205 003 FAN BLADE

MAN
51.06601.0264



21 205 004 FAN BLADE

MAN
51.06601.0178



21 205 005 FAN BLADE

MAN
51.06601.0266



21 205 102 FAN BLADE
9-BLADE

MAN
51.06601.0102



Motor / Engine

21 205 107	FAN BLADE
	9 blades
MAN	
51.06601.0107	



21 205 172	FAN BLADE
	8 blades
	F 2000
MAN	
51.06601.0172	
Scania	
1321876	



21 205 200	FAN BLADE
	9 blades
MAN	
51.06601.0200	



21 205 230	FAN BLADE
	10-blade
MAN	
51.06601.0230	



Motor / Engine

21 205 256 FAN BLADE

TGA

MAN
51.06601.0256



21 205 257 FAN BLADE

MAN
51.06601.0257

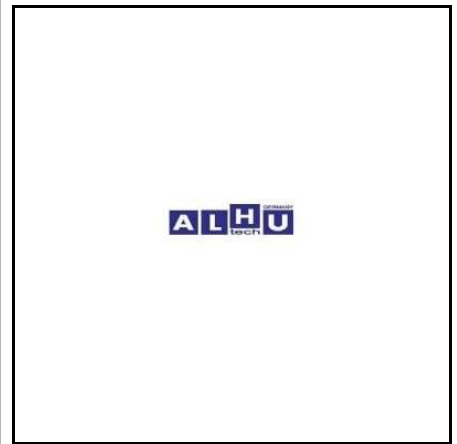

21 205 265 FAN BLADE

MAN
51.06601.0265

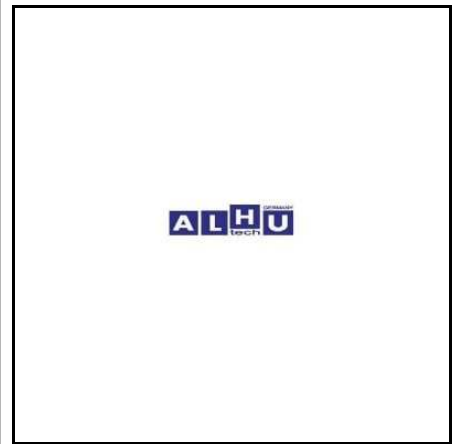

21 205 275 FAN BLADE

MAN
51.06601.0275

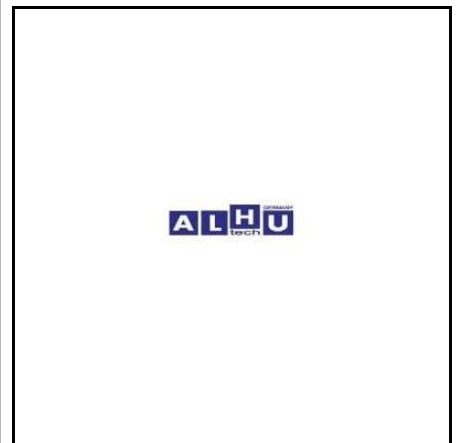

Motor / Engine

63 450 118	FAN BLADE
<p>MAN 51.06601.0261</p>	

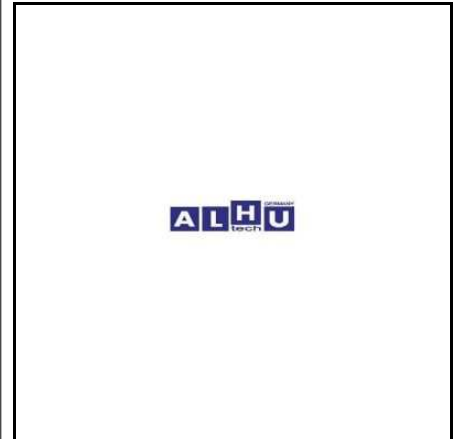

21 200 002	FAN CLUTCH
<p>compl. With fan</p> <p style="text-align: right;">SL 232</p>	
<p>MAN 81.06630.6072</p>	
<p>Behr/Hella 8MV 376 728-131</p>	

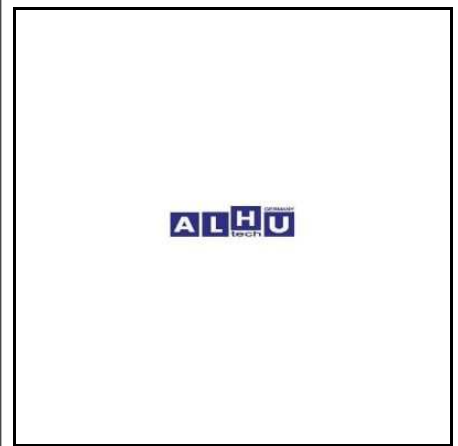

21 200 006	FAN CLUTCH
<p>with plastic fan</p> <p style="text-align: right;">19422</p>	
<p>MAN 51.06601.0243</p>	
<p>Behr/Hella 8MV 376 728-121</p>	

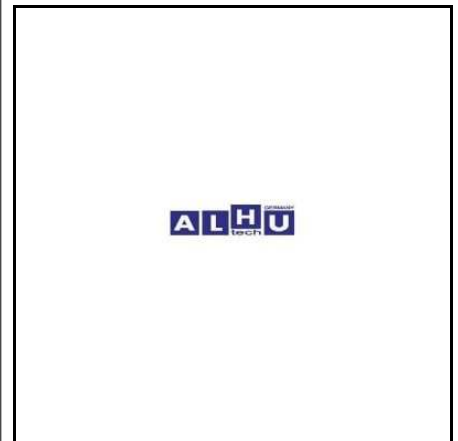

21 200 026	FAN CLUTCH
<p>with plastic blades</p> <p style="text-align: right;">TGA</p>	
<p>MAN 51.06600.7033</p>	

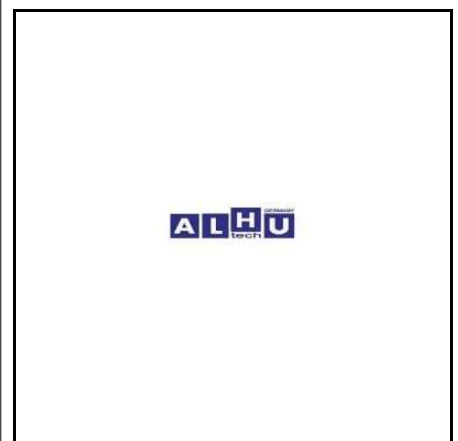

Motor / Engine

21 200 037 FAN CLUTCH

MAN
51.06630.0037
51.06630.0043



21 200 060 FAN CLUTCH

F 2000

MAN
51.06630.0060



21 200 066 FAN CLUTCH

MAN
51.06630.0066



21 200 067 FAN CLUTCH
6 holes

MAN
51.06630.0067



Motor / Engine

21 200 068 FAN CLUTCH

MAN
51.06630.0068



21 200 072 FAN CLUTCH

MAN
51.06630.0072



21 200 074 FAN CLUTCH

MAN
51.06630.0074

BERU
LK 104



21 200 077 FAN CLUTCH

TGA

MAN
51.06630.0077



Motor / Engine

21 200 092 FAN CLUTCH

MAN
51.06601.0227



21 200 093 FAN CLUTCH

MAN
51.06630.0071



21 200 094 FAN CLUTCH

MAN
51.06630.0119



21 200 095 FAN CLUTCH

MAN
51.06600.7046



Motor / Engine

21 200 096 FAN CLUTCH

MAN
51.06600.7015
51.06600.7045



21 200 107 FAN CLUTCH

MAN
51.06630.0131



21 200 112 FAN CLUTCH

MAN
51.06630.0112



21 200 115 FAN CLUTCH

TGA

MAN
51.06630.0115

ZF Trading GmbH
2100 040 431



Motor / Engine

21 200 129 FAN CLUTCH

TGA

MAN
51.06630.0129



21 200 130 FAN CLUTCH

TGA TGS TGX

MAN
51.06630.0130

BERU
LK 028



21 201 039 FAN CLUTCH

SL 232

MAN
81.06630.6039



21 201 047 FAN CLUTCH

MAN
51.06630.0047

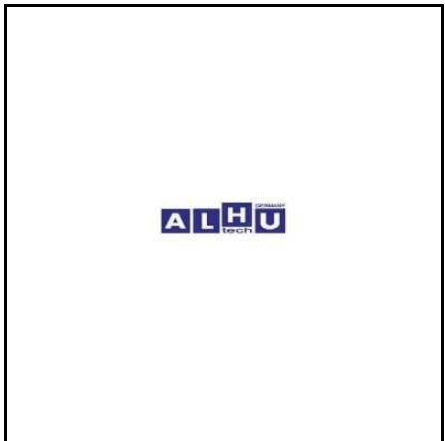

Motor / Engine

63 450 817 FAN CLUTCH

MAN
51.06630.0082



63 453 043 FAN CLUTCH



MAN
81.06630.6038

Behr/Hella
8MV 376 727-281



21 200 005 FAN CLUTCH ADAPTOR

TGA

MAN
51.06604.0061



63 450 633 FILTER HEAD

MAN
51.12504.0008



Motor / Engine

63 450 634 FILTER HEAD

MAN
51.12504.6003

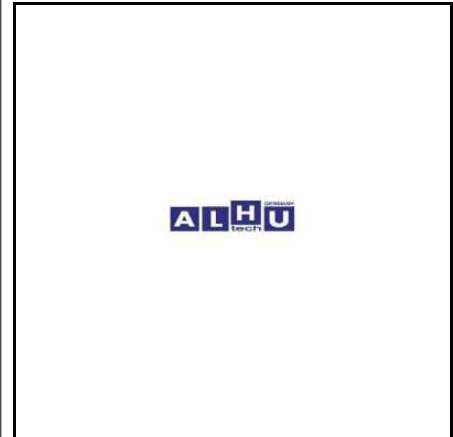

63 450 635 FILTER HEAD

MAN
51.12504.6004

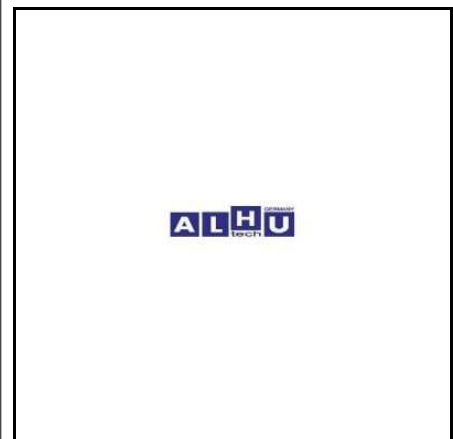

21 094 051 FILTER HOUSING
complete with clips

F 2000

MAN
81.08303.6051

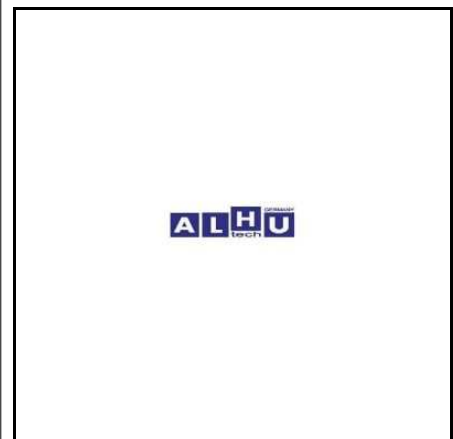

28 000 003 FILTER HOUSING

MAN
81.08304.0023

Mercedes Benz
000 094 30 04
31 100 54 113

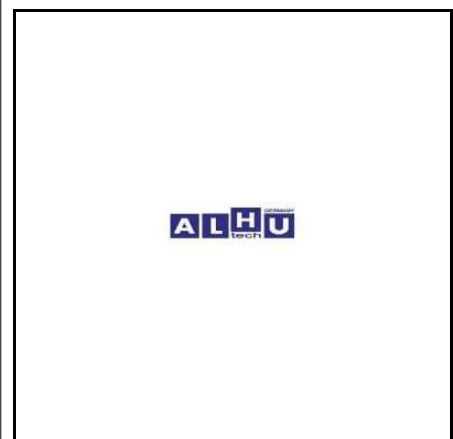

Motor / Engine

21 830 013 FLUID RESERVOIR

MAN
81.61910.0013

Mercedes Benz
000 830 17 83



21 830 023 FLUID RESERVOIR

TGA TGX

MAN
81.61910.6023
81.61910.6045



21 030 034 FLYWHEEL
430 mm

TGA

MAN
51.02301.6034



21 030 043 FLYWHEEL

MAN
51.02301.6043

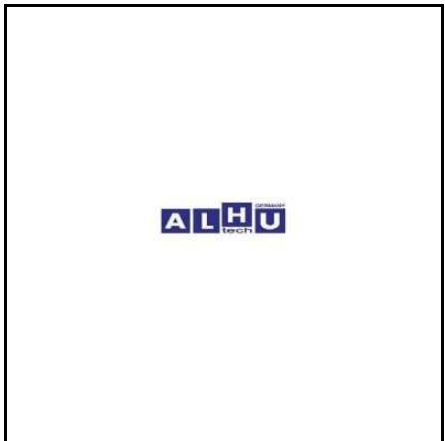

Motor / Engine

21 030 258 FLYWHEEL

TGA

MAN
51.02301.5258

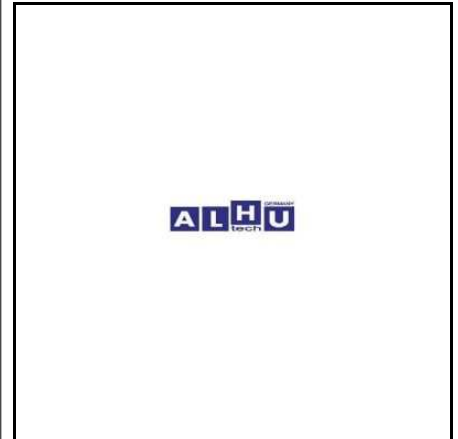

21 030 321 FLYWHEEL

MAN
51.02301.5121

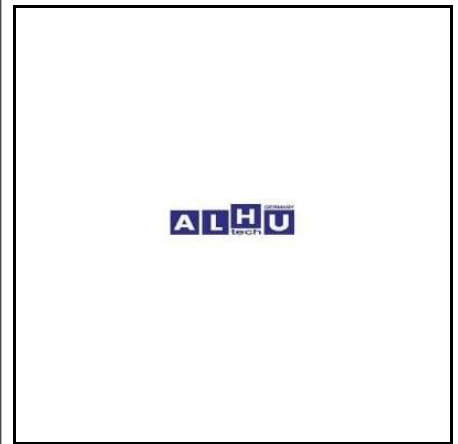

21 030 402 FLYWHEEL

380 MM

OM 401 - 402

MAN
51.02301.7295

Mercedes Benz
403 030 13 05

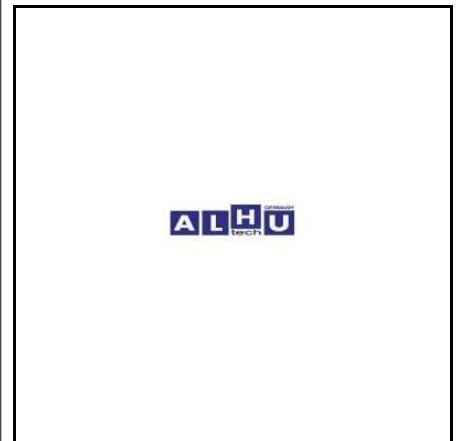

21 030 403 FLYWHEEL

420 mm

MAN
51.02301.7300

Mercedes Benz
403 030 14 05

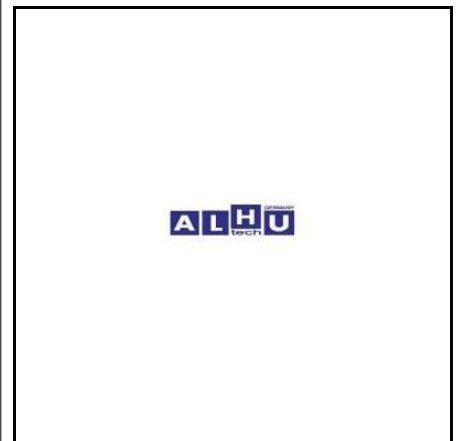

Motor / Engine

21 030 439 FLYWHEEL

MAN
51.02301.7439

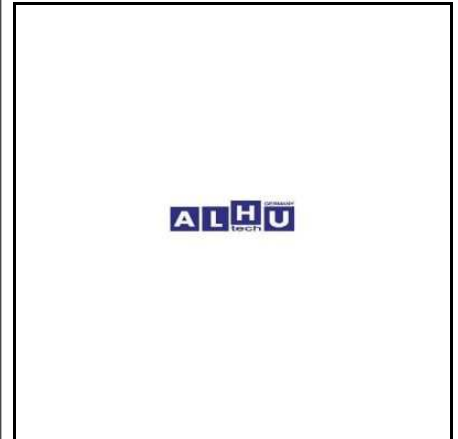

21 030 441 FLYWHEEL
400 mm

MAN
51.02301.7410

Mercedes Benz
441 030 04 05

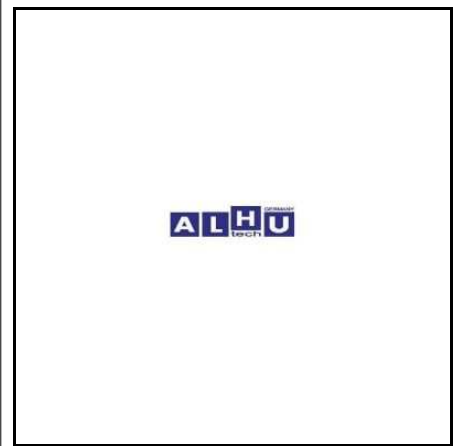

21 030 442 FLYWHEEL
430 mm

Mercedes Benz
442 030 02 05

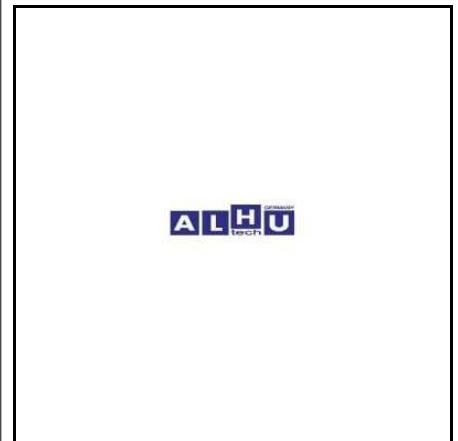

28 030 009 FLYWHEEL

MAN
51.02301.7440

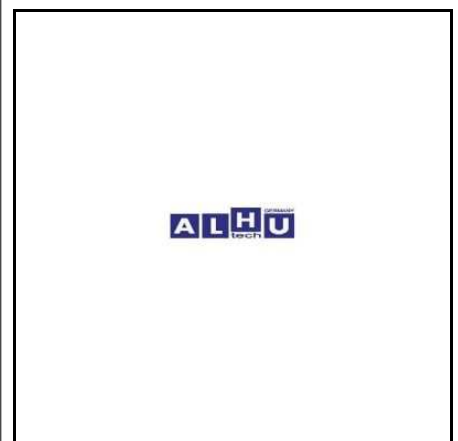

Motor / Engine

28 030 010 FLYWHEEL

MAN
51.02301.7389



28 030 011 FLYWHEEL

TGA

MAN
51.02301.6033



28 030 013 FLYWHEEL

MAN
51.02301.5109



28 030 014 FLYWHEEL

SL 232

MAN
51.02301.6050



Motor / Engine

28 030 015	FLYWHEEL
	dual mass
MAN	
51.02301.6044	
Neoplan	
110688876	

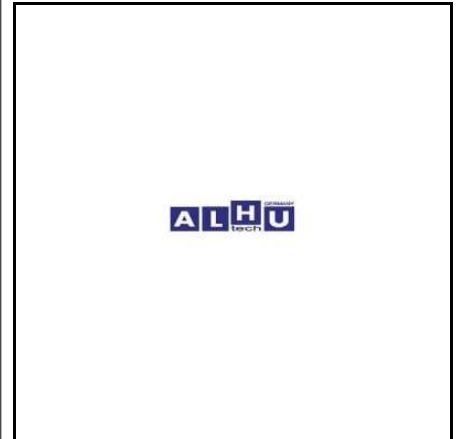

28 030 021	FLYWHEEL
MAN	
51.02301.5167	

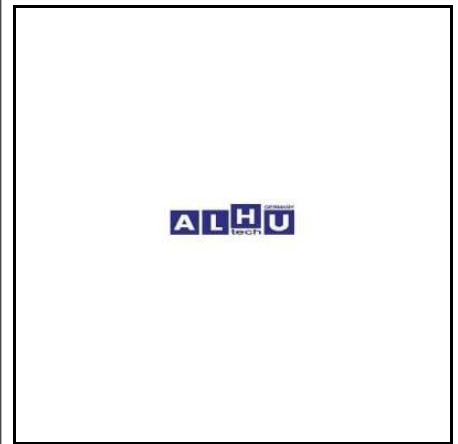

28 030 259	FLYWHEEL
MAN	
51.02301.5259	

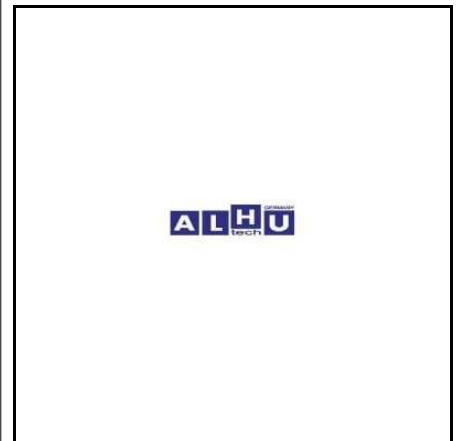

21 030 086	FLYWHEEL RING GEAR
MAN	
51.02310.0086	



Motor / Engine

21 030 087 FLYWHEEL RING GEAR

MAN
51.02310.0087



21 030 097 FLYWHEEL RING GEAR

MAN
51.02310.0097

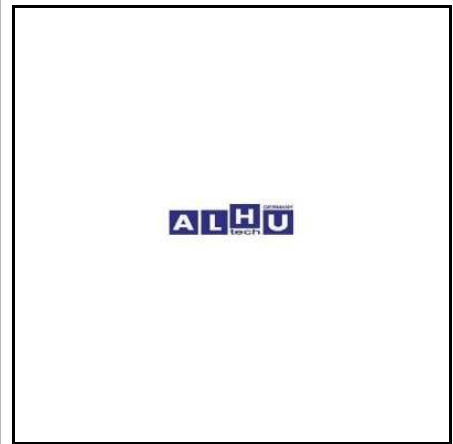

21 040 003 FUEL FEED PUMP

MAN
51.12101.7038
81.12101.6022

Mercedes Benz
000 090 03 50

Bosch
0 440 008 999



21 440 002 FUEL FEED PUMP

MAN
51.12101.7101

Bosch
0 440 008 173

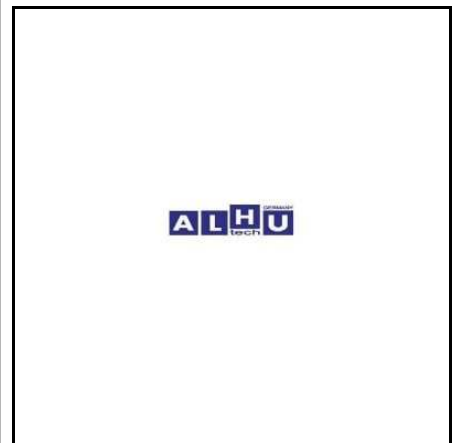

Motor / Engine

21 440 007 FUEL FEED PUMP	
<p>MAN 51.12150.7022</p> <p>Bosch 0 440 011 002 0 440 011 007</p>	<p>Mercedes Benz 000 091 21 90</p> <p>KHD 1180583 2408351</p>



21 440 009 FUEL FEED PUMP	
<p>Bosch 0 440 008 009</p>	



21 440 040 FUEL FEED PUMP	
<p>MAN 51.12101.7019</p> <p>Bosch 0 440 004 040</p>	



21 440 084 FUEL FEED PUMP	
<p>MAN 51.12101.7106</p> <p>Bosch 0 440 008 084</p>	



Motor / Engine

21 440 089 FUEL FEED PUMP

MAN
51.12101.7121

Volvo
863474
1307770

Bosch
0 440 008 089



21 440 092 FUEL FEED PUMP

MAN
51.12101.7107

Bosch
0 440 008 092



21 440 171 FUEL FEED PUMP

MAN
51.12101.7099

Bosch
0 440 008 171

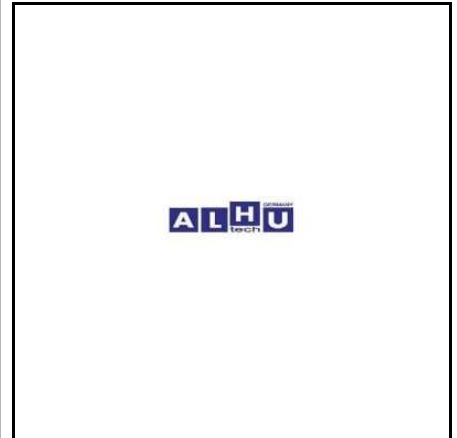

21 440 174 FUEL FEED PUMP

MAN
51.12101.7102

Bosch
0 440 008 174

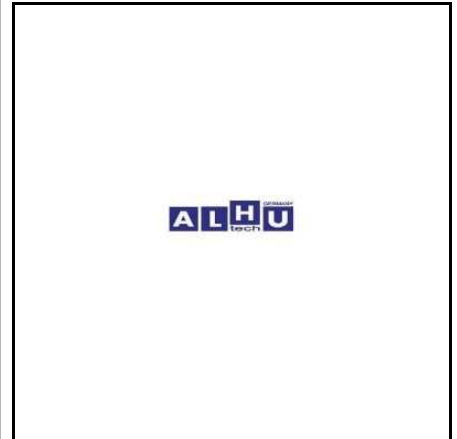

Motor / Engine

21 440 177 FUEL FEED PUMP

MAN
51.12101.7034

Mercedes Benz
000 090 27 50

Bosch
0 440 003 996



21 440 183 FUEL FEED PUMP

MAN
51.12101.7035

Bosch
0 440 003 246



21 440 245 FUEL FEED PUMP

MAN
51.12101.7039

Bosch
0 440 003 245

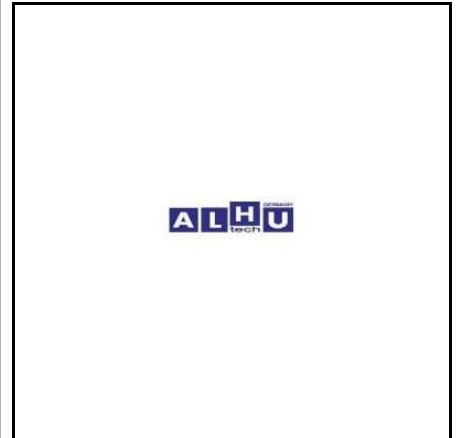

21 440 998 FUEL FEED PUMP

MAN
51.12101.7040

Mercedes Benz
000 090 05 50

Bosch
0 440 008 007
0 440 008 998

Volvo
244391
1699140



Motor / Engine

21 090 115 FUEL FILTER 2 STAGES

MAN
51.12501.7115

**63 450 655 FUEL PREFILTER**

MAN
81.12501.6082

**63 450 656 FUEL PREFILTER COVER**

MAN
81.12504.6011

**63 450 657 FUEL PREFILTER VALVE**

MAN
81.12510.0027



Motor / Engine

28 000 006 FUEL PUMP

MAN
51.12101.7047
51.12101.7136

Kolbenschmidt
7.02242.07.0



28 000 007 FUEL PUMP

MAN
51.12101.7046
51.12101.7137

Kolbenschmidt
7.02242.06.0



63 451 662 FUEL PUMP

 **MAN**
51.12150.0002



21 904 195 GASKET

MAN
51.05904.0195



Motor / Engine

63 451 333 GASKET

MAN
51.08901.0096



21 092 000 GASKET SET
for SEPAR filter

MAN
81.12902.6000



21 092 001 GASKET SET
for SEPAR filter

MAN
81.12902.6001



28 107 064 GUIDE PIECE, TENSIONER

MAN
51.19107.0064



Motor / Engine

21 447 000 HAND PUMP	
with spring	
MAN 51.12150.7002	Mercedes Benz 000 091 11 01
Bosch 2 447 222 000	



21 447 033 HAND PUMP	
MAN 81.12150.6013	DAF 248559
Bosch 2 447 010 038	



21 095 011 HEATER HOSE	
MAN 81.96305.0217	



21 095 012 HEATER HOSE	
MAN 81.96305.0235	

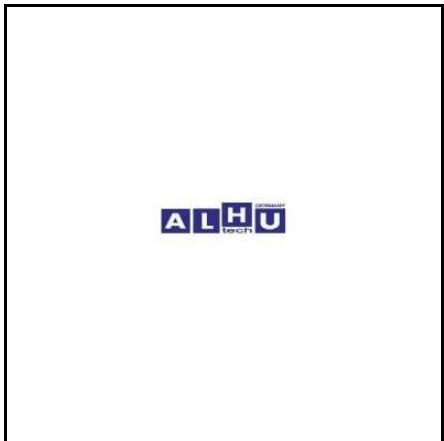

Motor / Engine

21 095 013 HEATER HOSE

MAN
81.96305.0262



21 095 014 HEATER HOSE

TGA

MAN
81.96305.0272



63 451 135 HEATER VALVE

MAN
81.61980.0043



63 451 136 HEATER VALVE

MAN
81.61967.6015



Motor / Engine

63 451 334 HEX SCREW

MAN
51.90020.0298



28 010 242 HEX. BOLT

MAN
51.90020.0242



63 450 281 HEX. SCREW

MAN
51.90490.0032



21 070 167 HOLLOW SCREW

MAN
51.98150.0167



Motor / Engine**63 450 650 HOLLOW SCREW**

MAN
51.98150.0110

**63 451 335 HOSE**

MAN
51.96301.0108

**21 970 205 HOSE CLAMP**

MAN
81.97440.0205

**63 450 586 HOSE CLAMP**

MAN
06.67124.1024



Motor / Engine

63 450 587 HOSE PIPE

MAN
06.54059.0007



21 203 022 INJECTION LINE

MAN
51.10300.6029



21 203 001 INJECTION LINE SET

MAN
51.10303.6177



21 203 002 INJECTION LINE SET

MAN
51.10303.6115



Motor / Engine

21 203 003 INJECTION LINE SET

MAN
51.10300.6023

**21 203 013 INJECTION LINE SET**

MAN
51.10300.6032

**21 203 016 INJECTION LINE SET**

MAN
51.10303.6191

**21 203 017 INJECTION LINE SET**

MAN
51.10303.6144



Motor / Engine

21 203 018 INJECTION LINE SET

MAN
51.10303.6025



21 203 019 INJECTION LINE SET

MAN
51.10301.6176



21 203 020 INJECTION LINE SET

MAN
51.10301.6177



21 203 021 INJECTION LINE SET

MAN
51.10303.6159



Motor / Engine

21 203 031 INJECTION LINE SET

MAN
51.10303.6220

**63 450 629 INJECTION LINE SET**

MAN
51.10303.6107

**63 450 630 INJECTION LINE SET**

MAN
51.10303.6236

**21 997 065 INJECTOR WASHER**

MAN
51.98701.0065

Mercedes Benz
346 017 01 60



Motor / Engine

21 997 091 INJECTOR WASHER

MAN
51.98701.0091



63 450 626 INLET MANIFOLD GASKET

MAN
51.08902.0179



28 613 141 INTERCOOLER

MAN
81.06130.0141



21 094 513 INTERCOOLER HOSE

MAN
81.96320.0162



Motor / Engine

21 094 582 INTERCOOLER HOSE

MAN
81.96301.0587



28 000 142 MOUNTING FLANGE FOR INJECTION PUMP

MAN
51.11401.0142

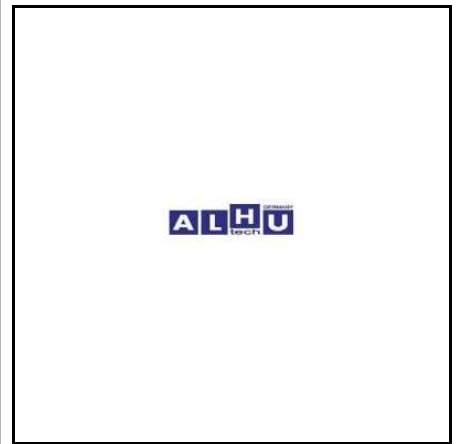

21 140 082 MULTIPIECE OIL RING

MAN
51.98701.0082

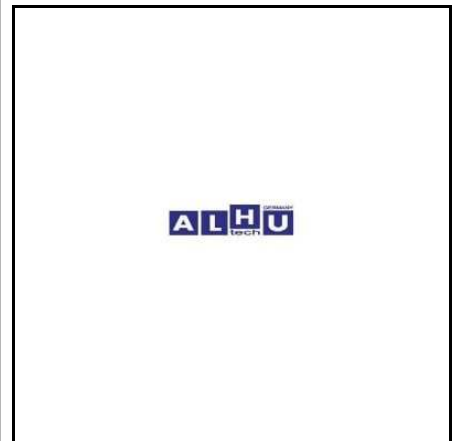

21 140 085 MULTIPIECE OIL RING

MAN
51.98701.0085

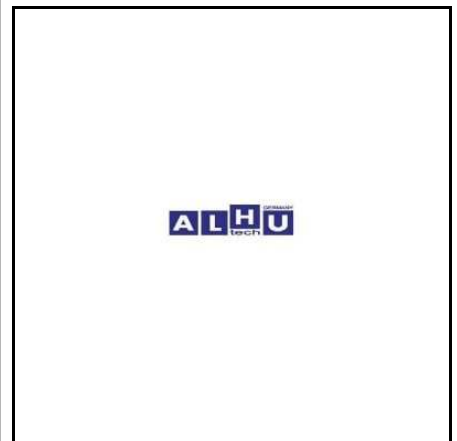

Motor / Engine

21 074 031 NOZZLE CAP NUT**MAN**

81.10109.0031

**63 450 653 NOZZLE CAP NUT****MAN**

81.10109.0024

**63 450 654 NOZZLE CAP NUT****MAN**

81.10109.0032

**21 188 001 OIL COOLER****MAN**

51.05601.0121

Mercedes Benz

001 188 31 01



Motor / Engine

28 560 017 OIL COOLER

MAN
81.05601.0017

Behr/Hella
8MO 376 726-421

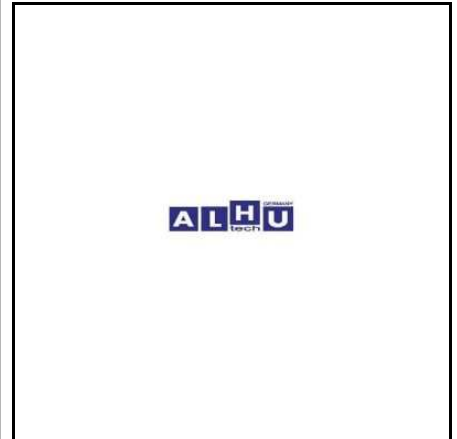

63 450 070 OIL COOLER

MAN
51.05601.0148



21 010 172 OIL DIPSTICK

MAN
51.05805.5335



21 010 414 OIL DIPSTICK

MAN
51.05805.5414

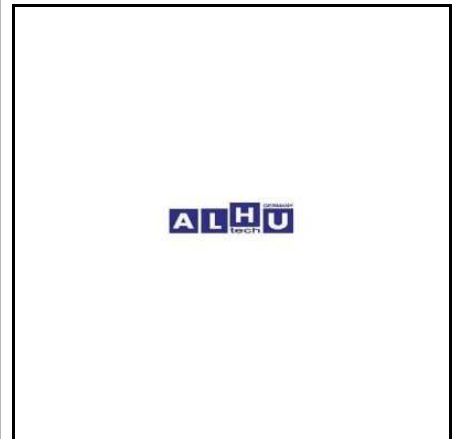

Motor / Engine

21 010 472	OIL DIPSTICK with green head
<p>MAN 51.05805.5609</p>	



63 450 605	OIL DIPSTICK
<p>MAN 51.05805.5304</p>	

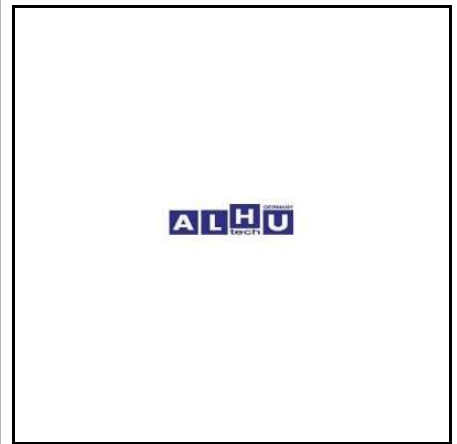

63 450 606	OIL DIPSTICK
<p>MAN 51.05805.5558</p>	

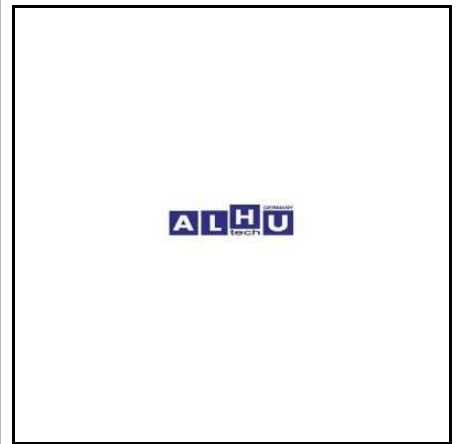

63 450 607	OIL DIPSTICK
<p>MAN 51.05805.5578</p>	

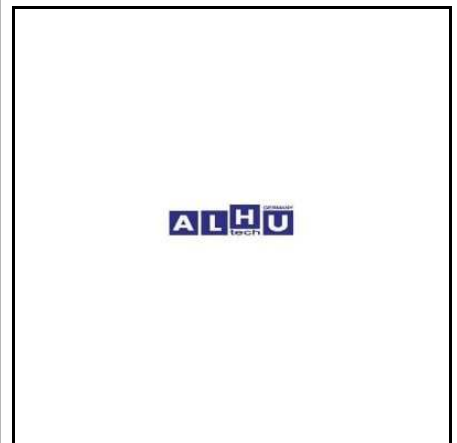

Motor / Engine

63 450 608 OIL DIPSTICK**MAN**
51.05805.5608**63 450 609 OIL DIPSTICK****MAN**
51.05805.5695**63 450 610 OIL DIPSTICK****MAN**
51.05805.5744**21 010 183 OIL DRAIN PLUG****MAN**
51.90310.0183

Motor / Engine

63 450 845 OIL FILLER HOSE

Mercedes Benz
403 018 11 82



28 503 094 OIL FILTER HEAD

MAN
51.05503.6094



21 180 438 OIL FILTER HEAD

MAN
51.05503.6006

Mercedes Benz
403 180 14 38



28 000 001 OIL FILTER HEAD

MAN
51.05503.6096

Mercedes Benz
407 180 11 38



Motor / Engine

63 450 602 OIL FILTER HEAD

MAN
51.05503.6105



63 450 603 OIL FILTER HEAD

MAN
51.05503.6093



63 450 604 OIL FILTER HEAD

MAN
51.05503.6106



63 450 583 OIL NOZZLE

Mercedes Benz
541 180 08 43



Motor / Engine

21 904 212 OIL PAN GASKET

TGA

MAN
51.05904.0212



28 000 002 OIL PAN GASKET

MAN
51.05904.0198



63 450 611 OIL PAN GASKET

MAN
51.05904.0197



21 180 115 OIL PRESSURE VALVE

D 0826

MAN
51.05405.5024



Motor / Engine

28 000 012 OIL PRESSURE VALVE

D 2566 D 2866

MAN
51.05405.7017

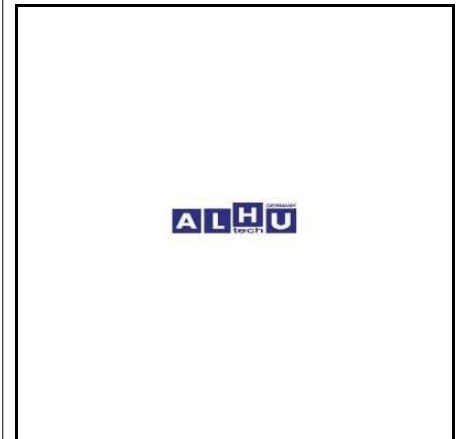

28 000 013 OIL PRESSURE VALVE

D 2566 D 2866

MAN
51.05405.7044

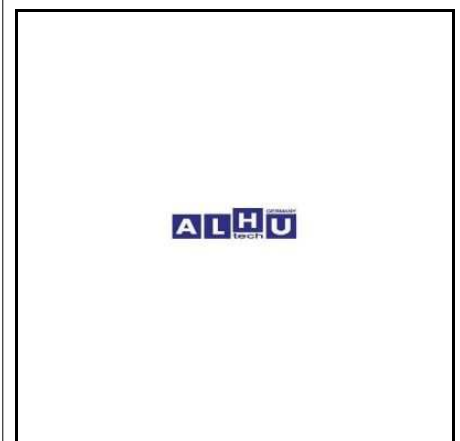

28 000 014 OIL PRESSURE VALVE

MAN
51.05405.0012

LASO
5518 1504

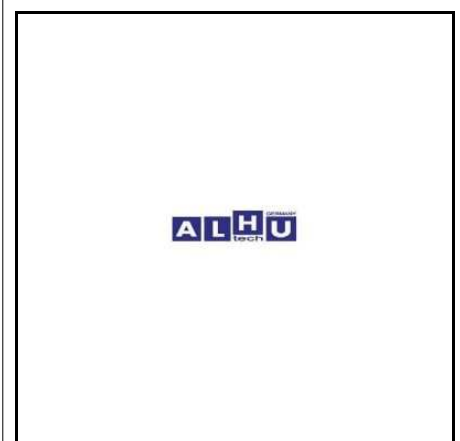

21 180 501 OIL PUMP

MAN
51.05100.6279

Mercedes Benz
423 180 05 01
423 180 25 01

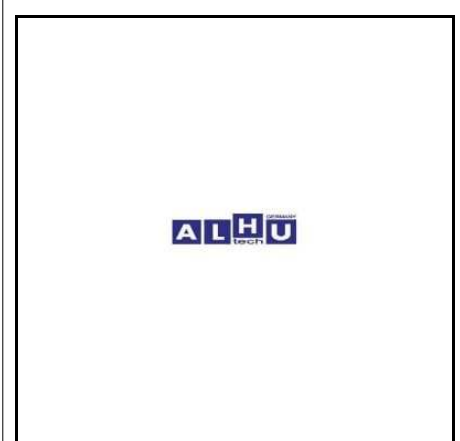

Motor / Engine

21 180 701 OIL PUMP

MAN
51.05100.6133

Mercedes Benz
403 180 17 01

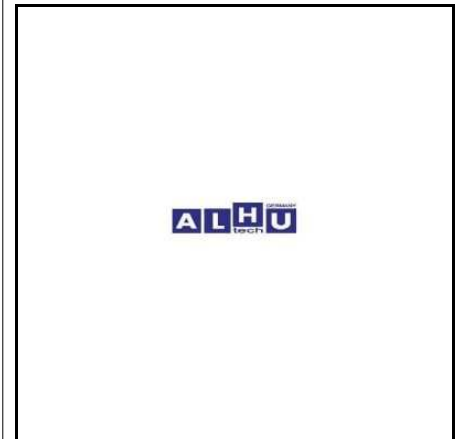

21 180 801 OIL PUMP

MAN
51.05100.6135

Mercedes Benz
403 180 28 01

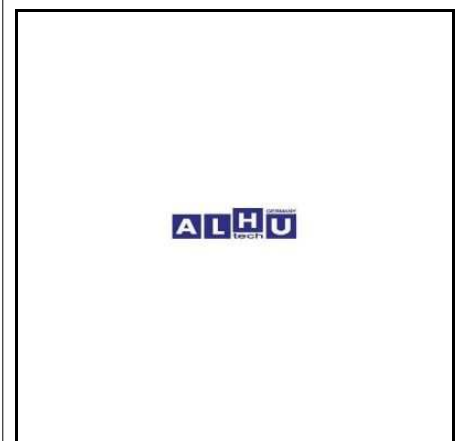

63 450 601 OIL PUMP GEAR

MAN
51.05201.0073

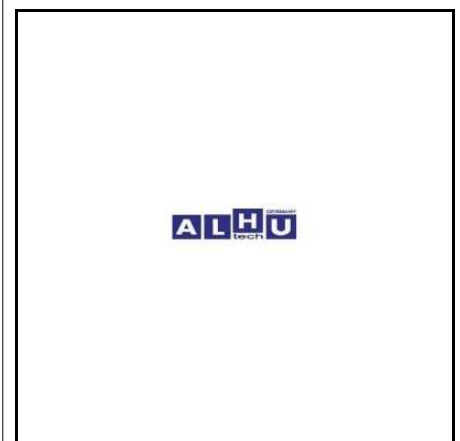

21 018 935 OIL SEPARATOR

MAN
51.01804.7032

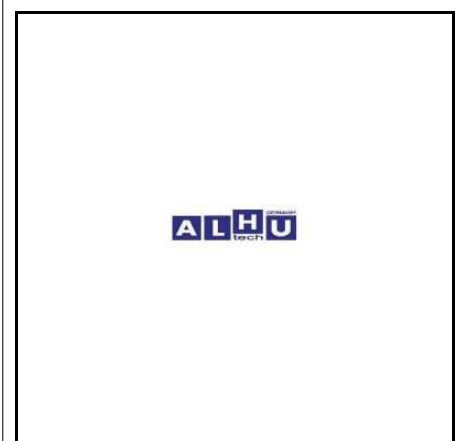

Motor / Engine

21 018 035 OIL SEPERATOR

D 2866

MAN
51.01804.7028



21 018 135 OIL SEPERATOR

D 2866

MAN
51.01804.7037



21 018 235 OIL SEPERATOR

D 2566 D 2866

MAN
51.01804.7023



21 018 435 OIL SEPERATOR

D 2566

MAN
51.01804.7026



Motor / Engine

21 017 066	OIL SPRAYER NOZZLE
	20 mm hight
	D 2566 D 2866
MAN	
51.01601.5066	



21 017 067	OIL SPRAYER NOZZLE
MAN	
51.01601.5082	

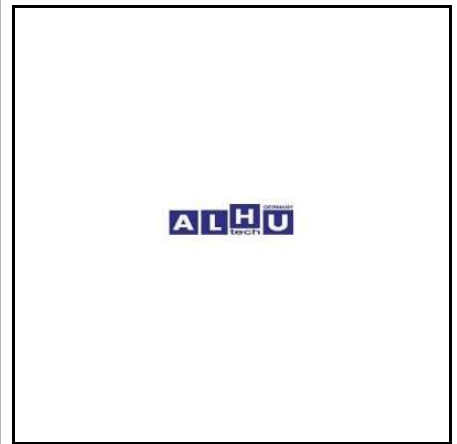

21 017 081	OIL SPRAYER NOZZLE
MAN	
51.01601.5081	

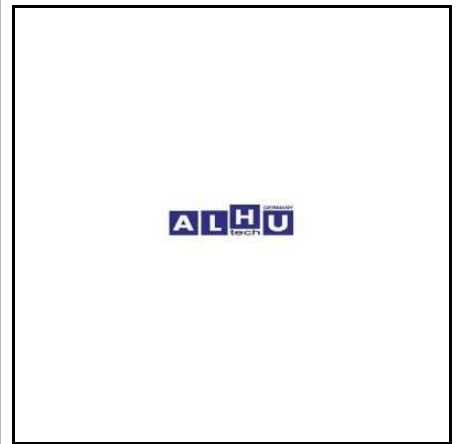

21 017 083	OIL SPRAYER NOZZLE
	D 2566 D 2866
MAN	
51.01601.5083	

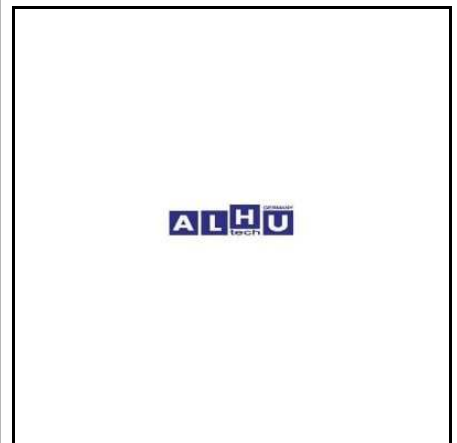

Motor / Engine

28 000 010 OIL SPRAYER NOZZLE

MAN
51.01601.5065



21 074 515 OVERFLOW VALVE

M 14 x 1,5

MAN
51.12505.0004

DAF
245187

Bosch
1 417 413 000

Mercedes Benz
000 074 05 15



21 074 584 OVERFLOW VALVE

Bosch
1 417 413 025

Mercedes Benz
000 074 06 84



21 074 684 OVERFLOW VALVE

Bosch
1 417 413 047

Mercedes Benz
000 074 76 84



Motor / Engine

63 450 141 PRESSURE LIMITER VALVE

MAN
81.52161.6318

KNORR
0481009050000



28 804 008 PRESSURE REGULATING VALVE

D 0836

MAN
51.01804.0008



21 017 003 PRESSURE SCREW

MAN
51.10108.0003

Mercedes Benz
403 017 02 71



21 074 005 PRESSURE SCREW

MAN
51.10108.0005



Motor / Engine

21 200 090 PRESSURE SPRING

MAN
51.97601.0290

TA501
T5021

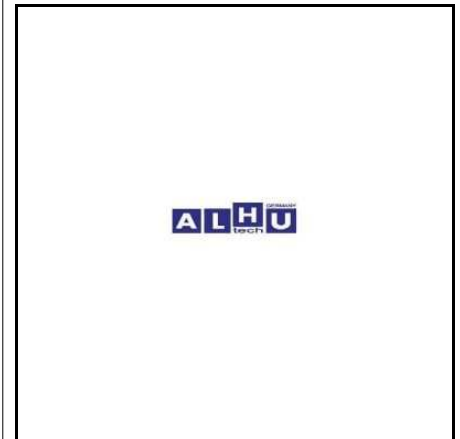

63 450 648 PROFILED CLAMP

MAN
51.97445.0033

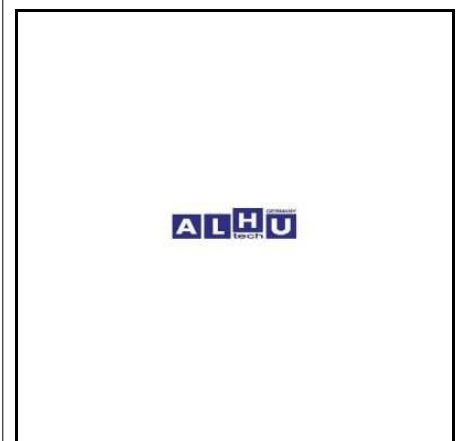

63 450 649 PROFILED CLAMP

MAN
51.97445.0076

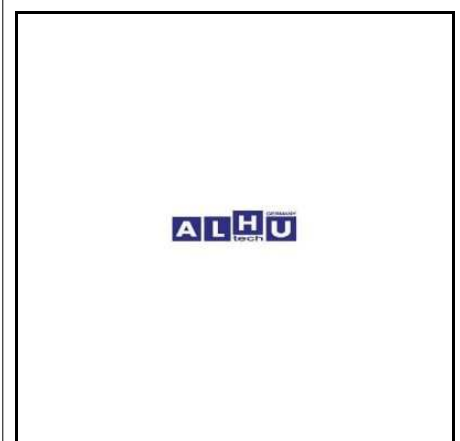

21 054 005 PUSH ROD

MAN
51.04302.0066

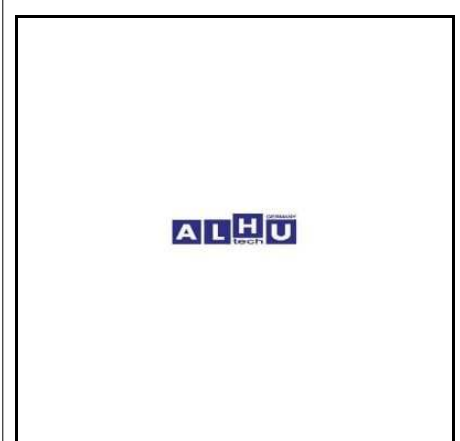

Motor / Engine

63 450 641 RACE

MAN
51.91701.0704



21 146 050 RADIATOR CAP

MAN
81.06110.0026

Mercedes Benz
000 501 45 15



21 146 350 RADIATOR CAP

MAN
81.06111.0018

Mercedes Benz
000 501 64 15



21 146 351 RADIATOR CAP

MAN
81.06111.0020

TA501
22045-00-135



Motor / Engine

63 450 647 RADIATOR CAP

MAN
51.97141.0016

**63 450 651 RADIATOR CAP**

MAN
81.06110.0007

**21 095 001 RADIATOR HOSE**

MAN
81.96301.0622

**21 095 002 RADIATOR HOSE**

MAN
81.96301.0894



Motor / Engine

21 095 003 RADIATOR HOSE

MAN
81.96301.0895



21 095 004 RADIATOR HOSE

MAN
81.96301.0896



21 095 005 RADIATOR HOSE

MAN
81.96301.0904



21 095 006 RADIATOR HOSE

MAN
81.96301.0906

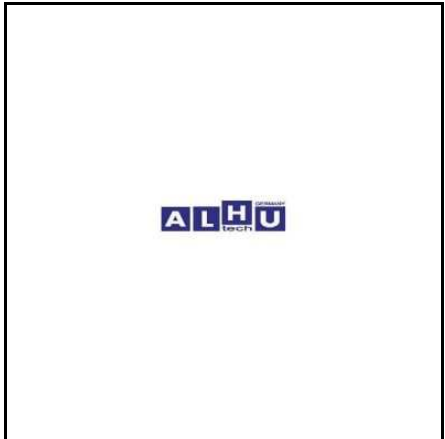

Motor / Engine

21 095 007 RADIATOR HOSE

MAN
81.96305.0166



21 095 008 RADIATOR HOSE

MAN
81.96305.0192



21 095 009 RADIATOR HOSE

MAN
81.96305.0197



21 095 010 RADIATOR HOSE

MAN
81.96305.0200

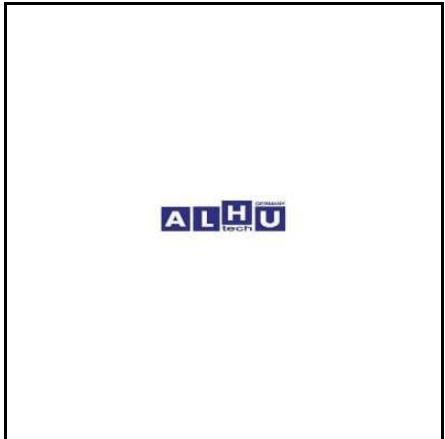

Motor / Engine

21 095 015 RADIATOR HOSE

MAN
81.96305.0304



21 095 682 RADIATOR HOSE

MAN
81.96305.0207



21 095 782 RADIATOR HOSE

MAN
81.96305.0312



21 500 088 RADIATOR HOSE

F 2000

MAN
81.96305.0088



Motor / Engine

21 500 659 RADIATOR HOSE

F 2000 TGA TGX

MAN
81.96301.0659
82.96301.0011



21 500 677 RADIATOR HOSE

F 2000

MAN
81.96301.0677

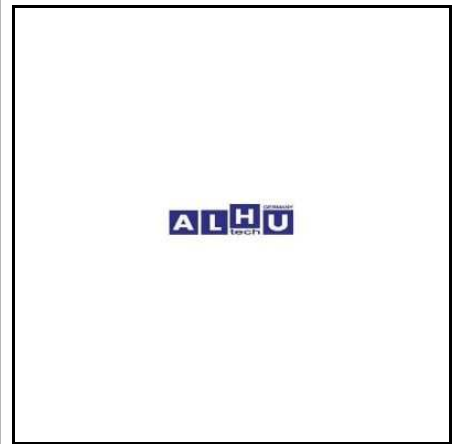

21 501 129 RADIATOR HOSE

MAN
81.96305.0129

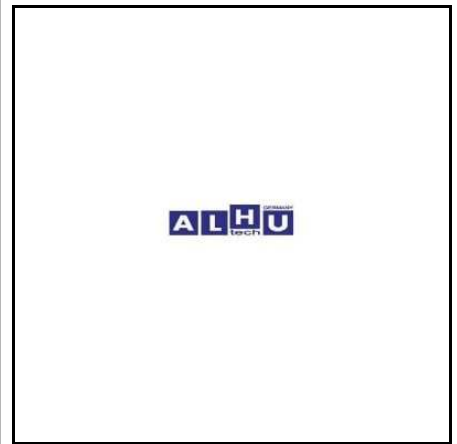

21 501 581 RADIATOR HOSE

MAN
81.96301.0581

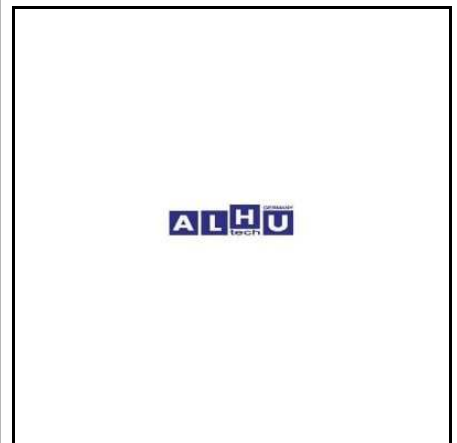

Motor / Engine

21 501 898 RADIATOR HOSE

TGA

MAN
81.96301.0898

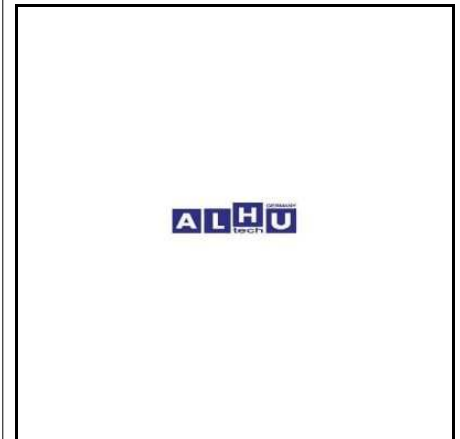

28 405 502 RADIATOR HOSE

MAN
04.27405.9502

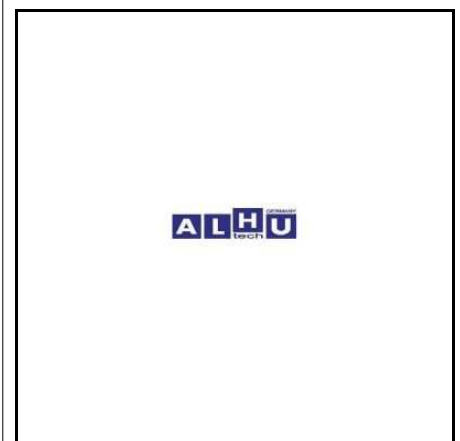

28 405 860 RADIATOR HOSE

MAN
04.27405.9860

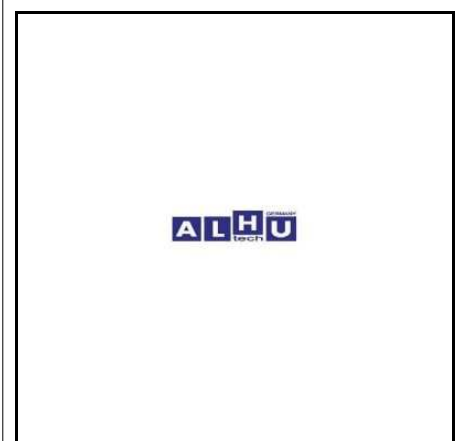

28 600 024 RADIATOR HOSE

MAN
04.27405.9160

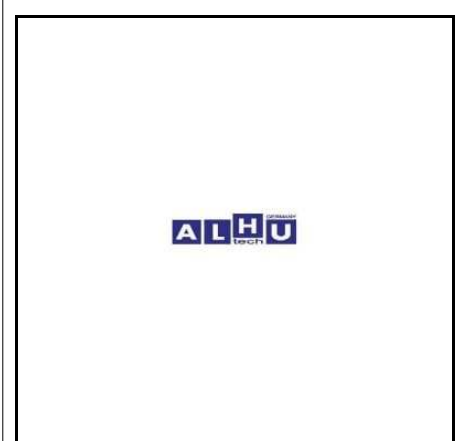

Motor / Engine

63 450 162 RADIATOR HOSE

MAN
04.27405.9550



63 450 848 RADIATOR HOSE

Mercedes Benz
617 501 49 82

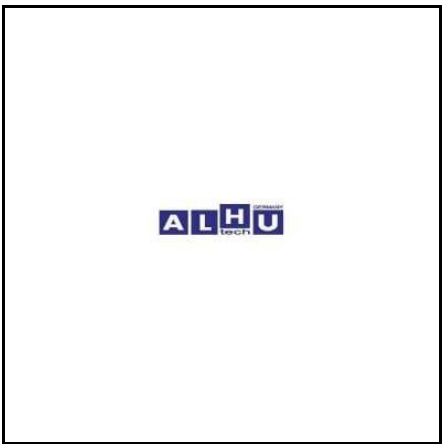

63 450 849 RADIATOR HOSE

Mercedes Benz
620 501 37 82

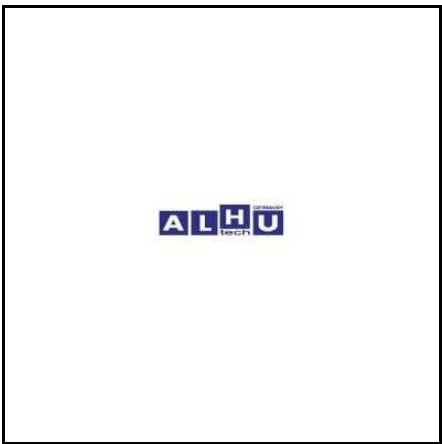

63 450 850 RADIATOR HOSE

Mercedes Benz
620 501 20 82

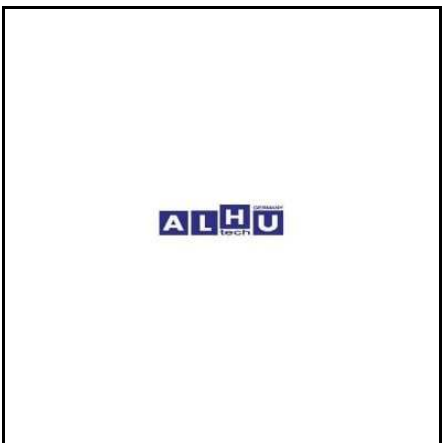

Motor / Engine

63 450 851 RADIATOR HOSE

Mercedes Benz
652 501 20 82



63 450 852 RADIATOR HOSE

Mercedes Benz
655 501 14 82



63 450 853 RADIATOR HOSE

Mercedes Benz
900 271 06 00 04



63 450 854 RADIATOR HOSE

Mercedes Benz
942 506 10 35



Motor / Engine

21 500 052 RADIATOR MOUNTING

MAN
81.96210.0052

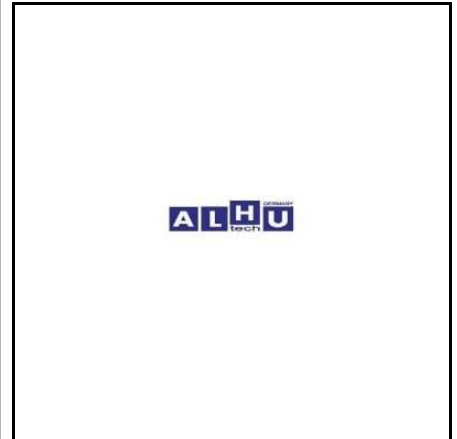

21 500 101 RADIATOR MOUNTING

MAN
81.96210.0101

Mercedes Benz
697 987 01 39



21 500 248 RADIATOR MOUNTING

MAN
81.96210.0248

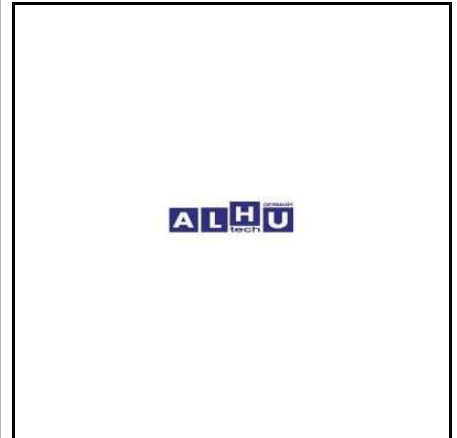

21 500 426 RADIATOR MOUNTING

F 2000

MAN
81.96210.0426



Motor / Engine

63 450 652 RADIATOR MOUNTING

MAN
81.06225.6008



21 205 659 RADIATOR RUBBER

MAN
81.96101.0659



21 501 639 REDUCING SLEEVE

MAN
81.96301.0639



25 545 524 RELAIS
flame start

MAN
81.25902.0524

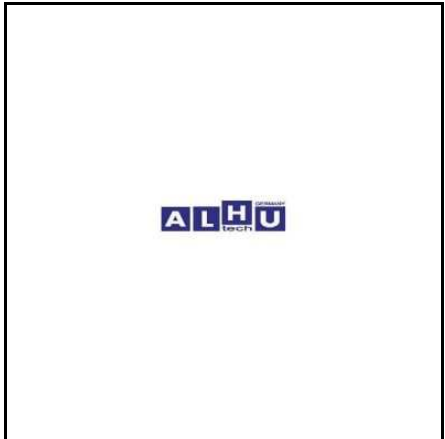

Motor / Engine

63 450 011 RELAY

L/M 2000

MAN
81.25935.6534



21 090 751 REPAIR KIT
pre-filter, complete

MAN
51.12503.0050
51.12503.0062

Mercedes Benz
000 090 07 51
000 092 33 03



21 447 017 REPAIR KIT

MAN
81.11101.6012

Mercedes Benz
000 091 08 40

Bosch
2 447 010 017



21 447 032 REPAIR KIT
fuel feed pump

MAN
81.11101.6151

Mercedes Benz
000 090 04 07

Bosch
2 447 010 032

RENAULT-TRUCKS
5001823651



Motor / Engine

21 050 236 ROCKER ARM BRACKET

MAN
51.04202.5034

Mercedes Benz
403 050 12 36



63 450 250 ROCKER SHAFT

MAN
51.04203.5058

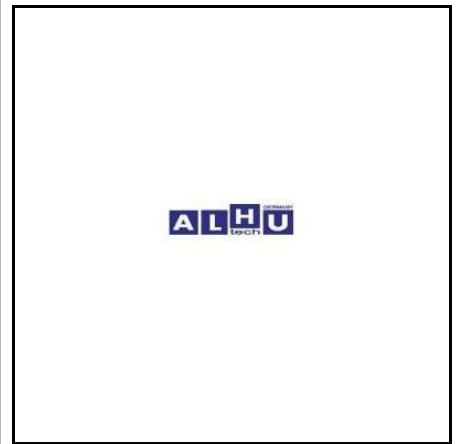

21 240 002 RUBBER MOUNTING

MAN
81.96210.0096



21 140 029 SCREW, EXHAUST MANIFOLD

MAN
51.90490.0029



Motor / Engine

21 140 030 SCREW, EXHAUST MANIFOLD

MAN
51.90490.0030



21 997 090 SEAL RING

MAN
51.98701.0090



21 997 093 SEAL RING

MAN
51.98701.0093



63 451 666 SEAL RING



MAN
81.08903.0109



Motor / Engine

21 997 348 SEAL RING, SEPERATOR

MAN
51.96501.0337

Mercedes Benz
000 997 53 48

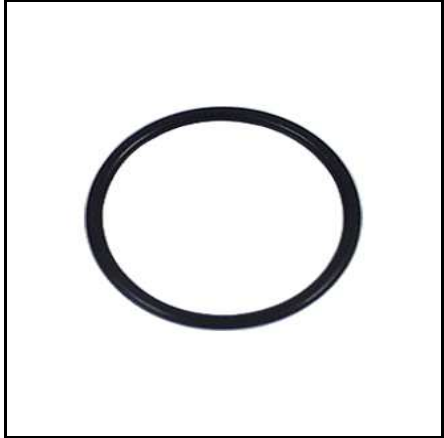

63 451 667 SPRING, AIR FILTER

 **MAN**
81.08340.0145



28 610 044 SPRING, BELT TIGHTENER

MAN
51.97610.0044



63 450 140 SQUARE SEAL
15,47X3,53 EPDM 70

MAN
81.96503.0226

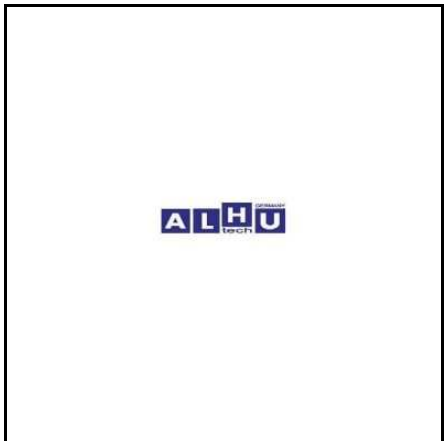

Motor / Engine

21 140 073 STUD

MAN
51.90201.0173



28 663 022 SUPPORTING ARM

MAN
51.06630.7022



63 450 251 T JUNCTION

MAN
51.98110.0177



21 018 006 TANK CAP

MAN
51.97141.7006

TA501
01040-00-005



Motor / Engine

21 146 352 TANK CAP	
unventilated	
MAN	
81.12210.6025	
BLAU	
01080-00-008	



21 146 353 TANK CAP	
plastic, ventilated	
MAN	Mercedes Benz
81.12210.6027	000 471 12 30
TA501	
21080-EV-906	



21 146 354 TANK CAP	
AD BLUE	
MAN	
81.15402.6027	



28 210 034 TANK CAP	
MAN	
81.12210.0034	



Motor / Engine

21 200 021 THERMOSTAT COVER

MAN
51.06405.0021



63 450 612 THERMOSTAT COVER

MAN
51.06301.0854



21 200 045 THERMOSTAT HOUSING

MAN
51.06404.0067



21 204 060 THERMOSTAT 60 DEGREES
with o-ring



Motor / Engine

21 204 065 THERMOSTAT 65 DEGREES
with o-ring



21 204 071 THERMOSTAT 71 DEGREES
with o-ring

MAN 51.06402.0065	Mercedes Benz 004 203 84 75 005 203 28 75
TA501 4150.71D50	

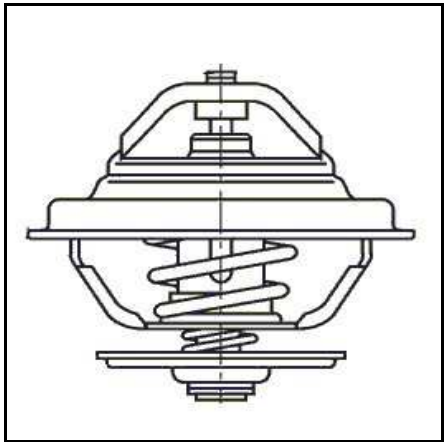

21 204 079 THERMOSTAT 79 DEGREES
with o-ring

MAN 51.06402.0061	
Mercedes Benz 005 203 27 75	

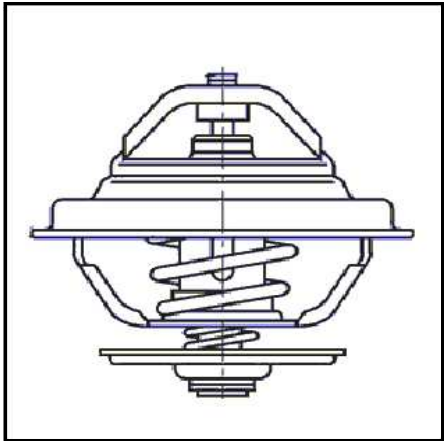

21 204 083 THERMOSTAT 83 DEGREES
with o-ring

MAN 51.06402.0060 51.06402.0063	Mercedes Benz 005 203 26 75
TA501 4150.83D50	

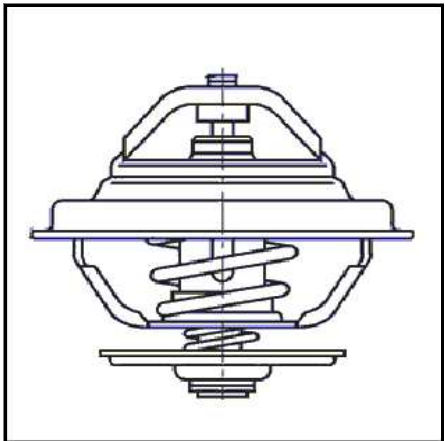

Motor / Engine

21 010 233 TIMING CASE

D 2566 D 2866

MAN
51.01401.6049

Mercedes Benz
407 015 07 02

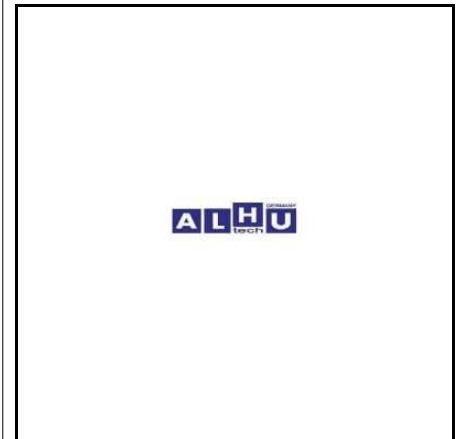

28 000 008 TIMING CASE

MAN
51.01304.6062

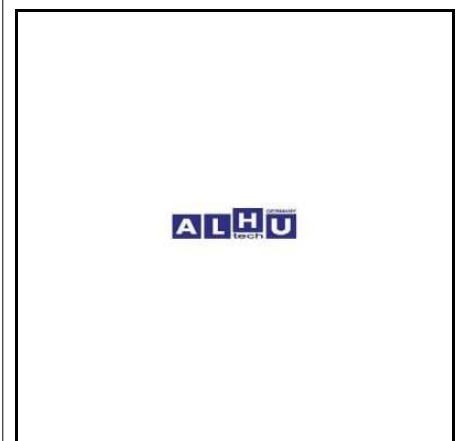

63 450 595 TIMING CASE GASKET

MAN
51.01901.0129

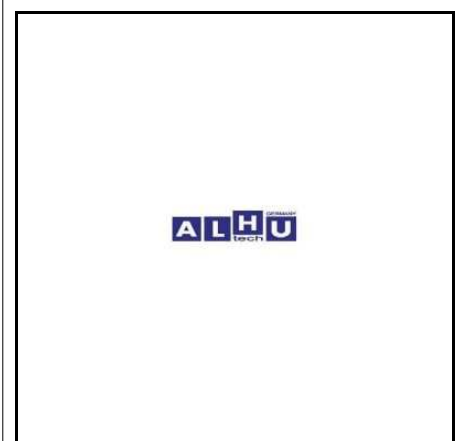

28 000 009 TIMING COVER

MAN
51.01305.5102

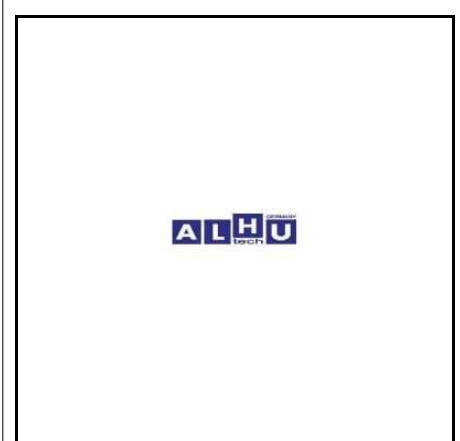

Motor / Engine

28 115 076 TIMING GEAR

MAN
51.02115.6076



21 030 182 TIMING GEAR - CRANKSHAFT

MAN
51.02115.0182



63 450 628 TURBO GASKET

MAN
51.09901.0036



21 094 083 TURBO HOSE

MAN
81.96301.0624



Motor / Engine

21 094 126 TURBO HOSE

MAN
81.96320.0126



21 094 182 TURBO HOSE

MAN
81.96320.0168



21 094 482 TURBO HOSE

L 2000

MAN
81.96320.0175



21 094 782 TURBO HOSE

MAN
81.96301.0600



Motor / Engine

21 094 783 TURBO HOSE

MAN
51.96330.0359



21 094 882 TURBO HOSE

TGA TGS TGX

MAN
81.96301.0900



21 094 883 TURBO HOSE

MAN
81.96301.0594



21 094 982 TURBO HOSE

MAN
81.96301.0590

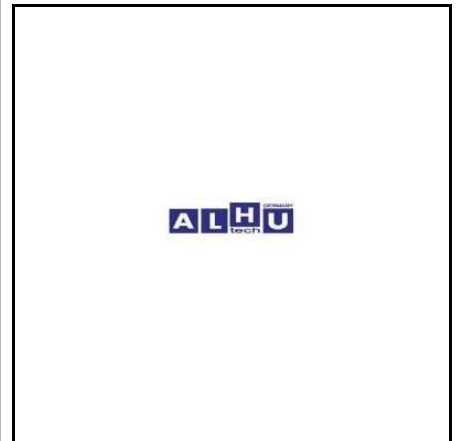

Motor / Engine

21 095 082 TURBO HOSE

MAN
81.96320.0132



21 095 382 TURBO HOSE

MAN
81.96320.0159



21 095 482 TURBO HOSE

MAN
81.96301.0648



21 095 582 TURBO HOSE

MAN
81.96301.0387

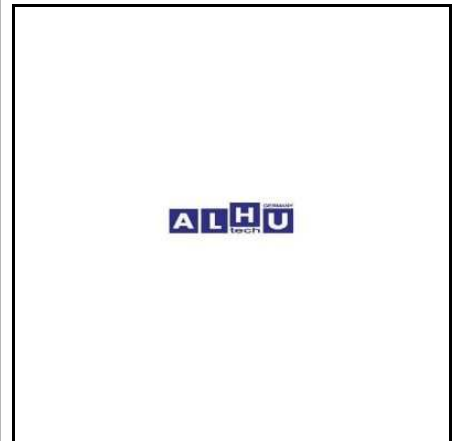

Motor / Engine

21 330 346 TURBO HOSE

MAN
51.96330.0346

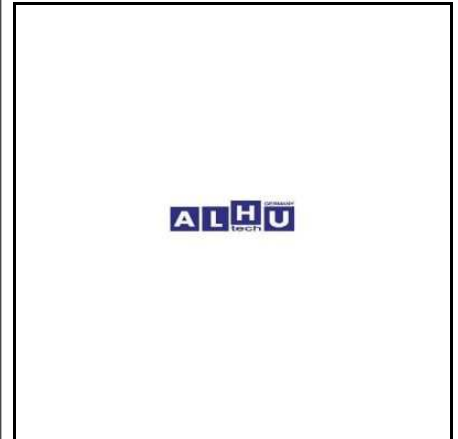

21 500 134 TURBO HOSE

MAN
81.96305.0134



63 450 204 TURBO HOSE

MAN
51.96420.0121

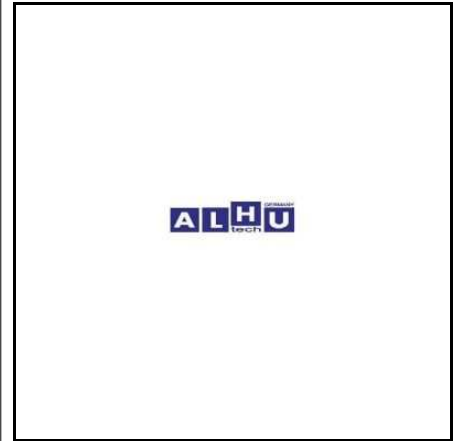

63 450 627 TURBO HOSE

MAN
51.09402.0030

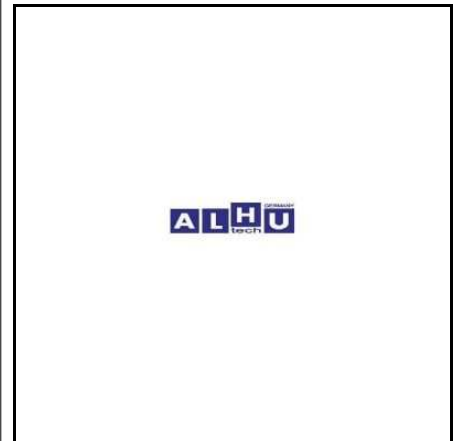

Motor / Engine

63 451 378 TURBO HOSE

MAN
81.96301.0321



63 451 379 TURBO HOSE

MAN
81.96301.0323



63 451 380 TURBO HOSE

MAN
81.96301.0458



06.3.02536 VALVE GUIDE

MAN
51.03201.0088



Motor / Engine

06.3.25102 VALVE GUIDE

MAN
51.03201.0102



22 260 163 VALVE SEAT RING

MAN
51.03203.0163



22 260 168 VALVE SEAT RING

MAN
51.03203.0168



22 260 171 VALVE SEAT RING

MAN
51.03203.0171



Motor / Engine

22 260 184 VALVE SEAT RING

MAN
51.03203.0184



22 260 242 VALVE SEAT RING

MAN
51.03203.0242



22 260 293 VALVE SEAT RING

MAN
51.03203.0293



21 050 025 VALVE TAPPET

MAN
51.04301.0109

Mercedes Benz
476 050 00 25



Motor / Engine

21 054 001 VALVE TAPPET

MAN
51.04301.0007



21 030 064 VIBRATION DAMPER

MAN
51.02201.0064



28 000 011 VIBRATION DAMPER
crankshaft

MAN
51.02201.0099



63 450 596 VIBRATION DAMPER

MAN
51.02201.0081



Motor / Engine

63 450 597 VIBRATION DAMPER

MAN
51.02201.0091

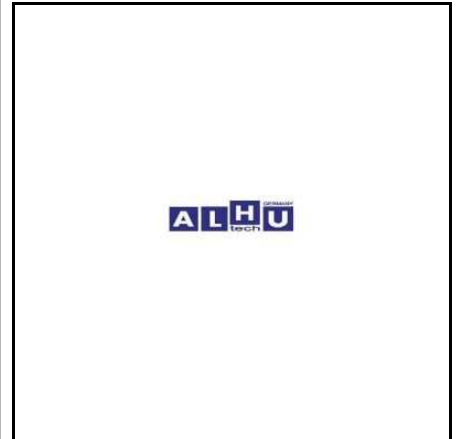

28 601 473 V-BELT PULLEY

MAN
51.02601.0473



28 601 506 V-BELT PULLEY

MAN
51.02601.0506



21 200 039 V-BELT PULLEY

D 2866 D 2876

MAN
51.95820.0039



Motor / Engine

21 200 079 V-BELT PULLEY

MAN
51.06503.0122

Mercedes Benz
403 202 06 10

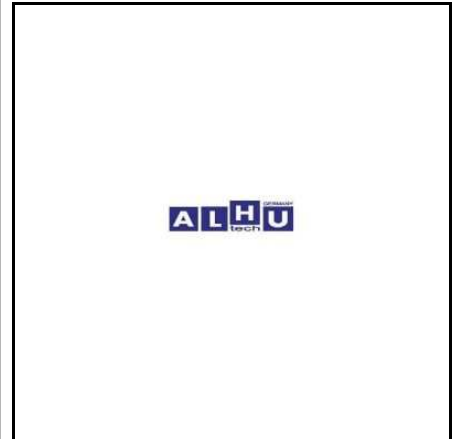

21 200 080 V-BELT PULLEY

MAN
51.06503.0123

Mercedes Benz
403 202 07 10



21 200 237 V-BELT PULLEY

MAN
51.06503.0237



21 200 325 V-BELT PULLEY

MAN
51.06503.0325

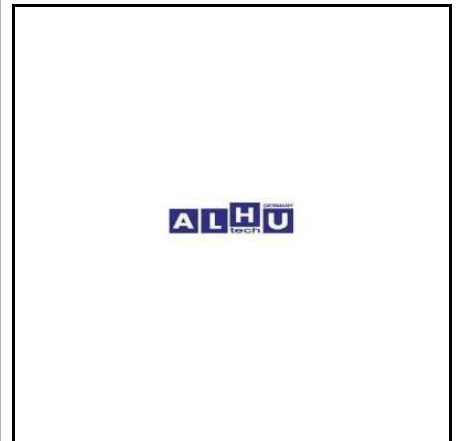

Motor / Engine

21 205 279 V-BELT PULLEY

MAN
51.06503.0279



28 105 075 V-BELT PULLEY

MAN
51.06606.0075



28 105 185 V-BELT PULLEY

MAN
51.26105.0185



28 105 248 V-BELT PULLEY

MAN
51.26105.0248



Motor / Engine

63 450 237 V-BELT PULLEY

MAN
51.26105.0247



63 450 254 V-BELT PULLEY

MAN
81.95820.0267



63 450 255 V-BELT PULLEY

MAN
81.06606.0147



63 450 256 V-BELT PULLEY

MAN
51.54201.0112



Motor / Engine

63 450 616 V-BELT PULLEY

MAN
51.06606.0062



63 450 617 V-BELT PULLEY

MAN
51.06606.0097



63 450 644 V-BELT PULLEY

MAN
51.26105.0301



63 450 618 WATER PIPE GASKET

MAN
51.06903.0030



Motor / Engine

21 200 011 WATER PUMP

MAN
51.06500.6495



21 200 036 WATER PUMP

MAN
51.06500.6228

Mercedes Benz
403 200 70 01



21 200 086 WATER PUMP

MAN
51.06500.6646
51.06500.6676



21 200 087 WATER PUMP

MAN
51.06500.6472



Motor / Engine

21 200 100 WATER PUMP



MAN
51.06500.6680
51.06500.9680



21 200 101 WATER PUMP

MAN
51.06500.6537
51.06500.9537



21 200 105 WATER PUMP



MAN
51.06500.6679
51.06500.9679



21 200 111 WATER PUMP

MAN
51.06500.6476



Motor / Engine

21 200 301 WATER PUMP

MAN
51.06500.6492
51.06500.9492



21 200 501 WATER PUMP

MAN
51.06500.6479

Mercedes Benz
403 200 75 01
422 200 12 01

TA501
220 816



21 200 515 WATER PUMP

MAN
51.06500.6515



21 200 547 WATER PUMP

MAN
51.06500.6547



Motor / Engine

21 200 601 WATER PUMP

MAN
51.06500.6426

Frimatec
220 836

Mercedes Benz
422 200 11 01



21 200 676 WATER PUMP

MAN
51.06500.7049
51.06500.9049



21 200 701 WATER PUMP

MAN
51.06500.6606
51.06500.6612
51.06500.6669



21 200 801 WATER PUMP

MAN
51.06500.6546
51.06500.9546

TA501
220 997



Motor / Engine

21 200 903 WATER PUMP

MAN
51.06500.6548



21 200 904 WATER PUMP

MAN
51.06500.6480



21 200 905 WATER PUMP

MAN
51.06500.6543
51.06500.6569



21 200 966 WATER PUMP

MAN
51.06500.7066
51.06500.7089
51.06500.9066

TA501
220 1065



Motor / Engine

21 200 081 WATER PUMP BEARING

MAN
51.93410.0116

FAG
527479C



21 999 002 WATER PUMP KIT

MAN
51.06599.6033



21 999 003 WATER PUMP KIT

MAN
51.06599.6052



21 470 004 WATER SEPARATOR FILTER

MAN 51.12503.6000	Mann + Hummel WK 1080/7X
Mercedes Benz 000 477 13 02	Racor R160T



Motor / Engine

21 470 001 WATER SEPERATOR FILTER

MAN

81.12503.0085
81.12503.0086

RENAULT-TRUCKS

5001864855



21 470 002 WATER SEPERATOR FILTER

MAN

81.12501.0022
81.12503.0080
85.12501.0002



Schalter / Switch

21 545 008 BRAKE LIGHT SWITCH

MAN
81.25520.0021

Mercedes Benz
000 763 14 10

Bosch
0 344 400 008
0 986 345 408



29 255 171 BRAKE LIGHT SWITCH

F 2000

MAN
81.25520.0171



63 453 051 BRAKE LIGHT SWITCH



MAN
81.25520.6007

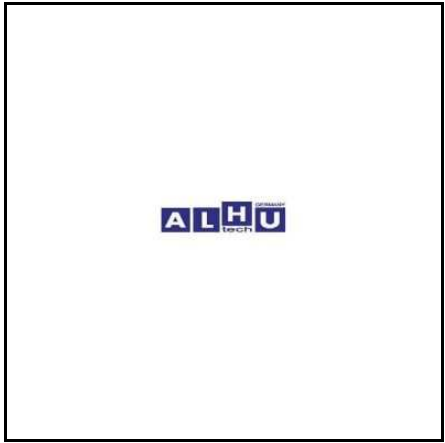

25 545 152 BRAKE SWITCH

F 2000

MAN
81.25520.0152



Schalter / Switch

29 255 070 BRAKE SWITCH

MAN
81.25509.0070

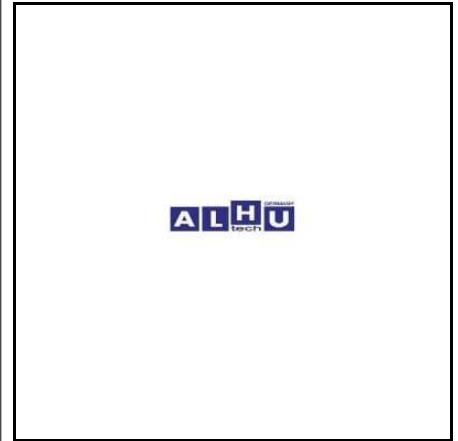

29 255 088 BRAKE SWITCH

MAN
81.25520.0088

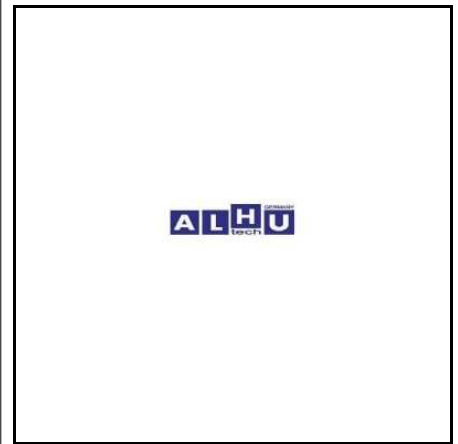

29 255 131 BRAKE SWITCH

MAN
81.25505.6131

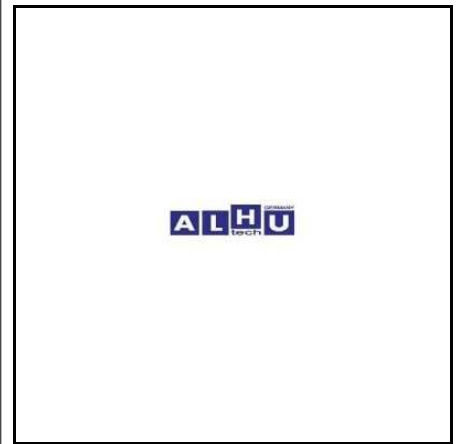

29 255 149 BRAKE SWITCH

MAN
81.25520.0149

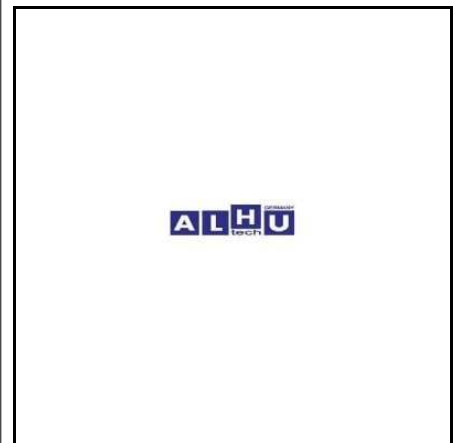

Schalter / Switch

29 255 152 BRAKE SWITCH
 SEUFFER quality
 F 2000

MAN
 81.25520.0152



70.583.050 CHANGE-OVER SWITCH



MAN
 81.25505.0462



29 255 179 CONTROL SWITCH

F 90

MAN
 81.25520.0079



29 255 100 CONTROL SWITCH

MAN
 81.25520.0100



Schalter / Switch

29 255 104 CONTROL SWITCH

MAN
81.25520.0104



29 255 106 CONTROL SWITCH

MAN
81.25520.0106



29 255 107 CONTROL SWITCH

MAN
81.25520.0107



29 255 117 CONTROL SWITCH

F 2000

MAN
81.25520.0117



Schalter / Switch

29 255 162 CONTROL SWITCH

MAN
81.25520.0162



29 255 176 CONTROL SWITCH

F 2000

MAN
81.25520.0076



63 450 009 CONTROL UNIT

MAN
88.25311.0002



25 927 099 DIODE RELAY

MAN
81.25927.0099



Schalter / Switch

28 820 010 DOOR CONTACT SWITCH

MAN
81.25505.0989

Mercedes Benz
000 821 05 52



29 255 706 ELECTRONIC CONTROL

F 2000

MAN
81.25935.6706



29 255 125 EXHAUST BRAKE SWITCH

MAN
81.25509.0125



29 255 006 FLUID LEVEL PROBE

MAN
81.15408.0006



Schalter / Switch

63 450 060 FLUID LEVEL PROBE

MAN
81.27421.0232



29 545 007 FOOT BRAKE SWITCH

MAN
81.25505.0992



63 451 663 HEAT SENSOR



MAN
51.27421.0213

Bosch
0 281 002 011



63 453 024 HEAT SENSOR



MAN
51.27421.0165



Schalter / Switch

63 451 127 HOUSING

MAN
81.25228.0014

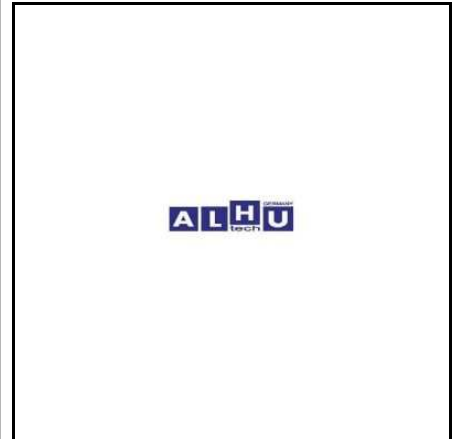

25 545 013 IGNITION SWITCH

with key

MAN
81.25501.6005

Mercedes Benz
000 545 30 13

Bosch
0 342 106 005



25 545 513 IGNITION SWITCH

7 Pin, 700 mm cable length

F 2000

MAN
81.25501.6033



25 545 613 IGNITION SWITCH

4 PIN, 700 mm cable length

F 2000

MAN
81.25501.6025



Schalter / Switch

25 545 713 IGNITION SWITCH
 4 PIN, 900 mm cable length

MAN
 81.25501.6020



29 255 146 INDICATOR

MAN
 81.27202.6146



25 545 000 MAIN BATTERY SWITCH

MAN 81.25506.7000	Mercedes Benz 000 545 25 08 000 545 84 08
Bosch 0 341 002 003	Volvo 240315



25 545 037 MAIN BATTERY SWITCH
 complete with key

MAN
 81.25506.6033
 81.25506.6037
 81.25506.6120



Schalter / Switch

25 545 038 MAIN BATTERY SWITCH KEY

MAN
81.25502.0018

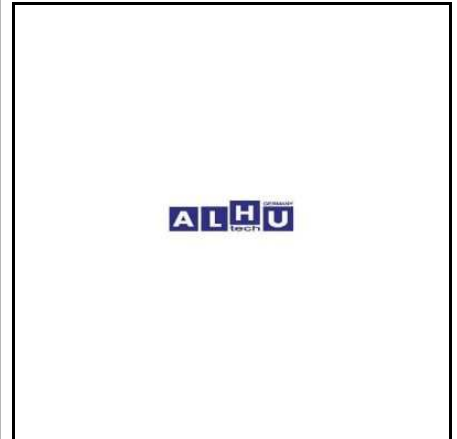

25 542 109 OIL PRESSURE SENDER

MAN
81.27421.0109



63 450 213 OIL PRESSURE SENDER

MAN
81.27421.0088



25 542 097 OIL PRESSURE SWITCH

F 2000

MAN
81.27421.0097

VDO
360.081-063-001C



Schalter / Switch

29 545 006 OIL PRESSURE SWITCH

MAN
81.27430.0005

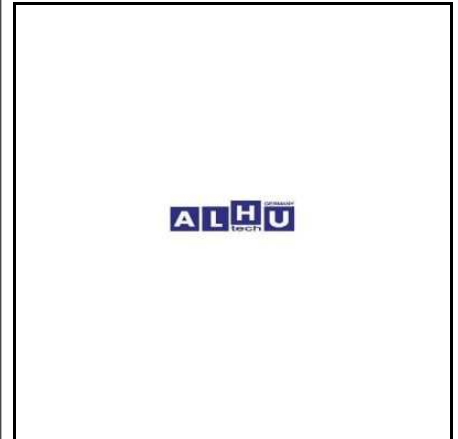

29 255 295 POTENTIOMETER

MAN
81.25907.0295

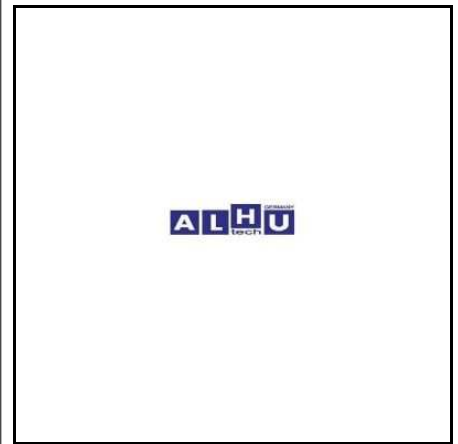

29 288 287 POTENTIOMETER

MAN
81.25907.0287

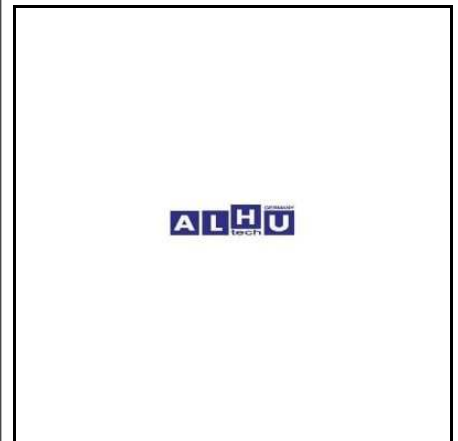

25 545 225 POTENTIOMETER SWITCH

MAN
81.25907.0225



Schalter / Switch

25 545 128 POWER CONTROL SWITCH

MAN
81.25503.6128



29 421 077 PRESSURE SENSOR

TGA TGS TGX TGL

MAN
81.27421.0227



29 421 151 PRESSURE SENSOR

 **MAN**
81.27421.0151



29 255 035 PRESSURE SWITCH

MAN
81.25514.0035



Schalter / Switch

29 255 163 PRESSURE SWITCH

MAN
81.25520.0163



29 255 167 PRESSURE SWITCH

MAN
81.25520.0167



29 255 177 PRESSURE SWITCH

TGA

MAN
81.25520.0177



29 255 184 PRESSURE SWITCH

F 2000 TGA

MAN
81.25520.0184



Schalter / Switch

29 255 187 PRESSURE SWITCH

MAN
81.25520.0187



29 255 190 PRESSURE SWITCH

MAN
81.25520.0190



29 255 191 PRESSURE SWITCH

MAN
81.25520.0191



29 255 195 PRESSURE SWITCH

MAN
81.25520.0195

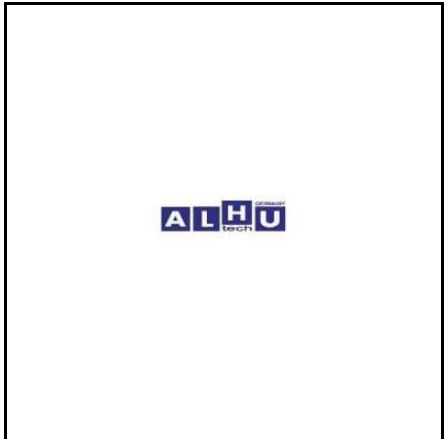

Schalter / Switch

29 255 209 PRESSURE SWITCH

MAN
81.25520.0209



29 255 210 PRESSURE SWITCH
6,5 Bar

MAN
81.25520.0210



29 503 244 PRESSURE SWITCH
differential lock

TGA TGS TGX

MAN
81.25503.0244



63 451 483 PRESSURE SWITCH



MAN
81.25521.6017



Schalter / Switch

63 451 485 PRESSURE SWITCH



MAN
81.25520.0043

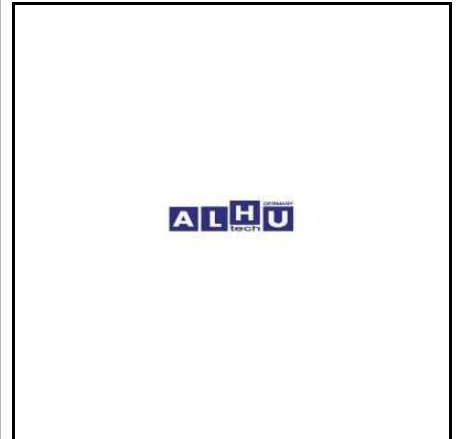

29 421 135 PULSE GENERATOR

MAN
81.27421.0135

ZF
0501 208 795



29 421 137 PULSE GENERATOR

MAN
81.27421.0137

ZF
0501 208 791



63 450 667 PULSE GENERATOR

MAN
81.27120.0016

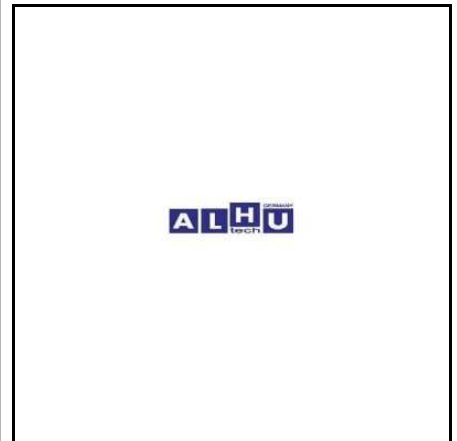

Schalter / Switch

63 450 095 PUSH BUTTON SWITCH
 green

MAN
 81.25503.6243

Mercedes Benz
 004 545 99 14



AK27501 PUSH KEY



MAN
 81.25503.0222

Mercedes Benz
 002 545 21 14



29 255 267 RELAY

F 2000 TGA TGX

MAN
 81.25902.6267



29 255 268 RELAY

MAN
 81.25902.6268



Schalter / Switch

63 451 129 RELAY

MAN
81.25902.0058

Mercedes Benz
000 545 72 05

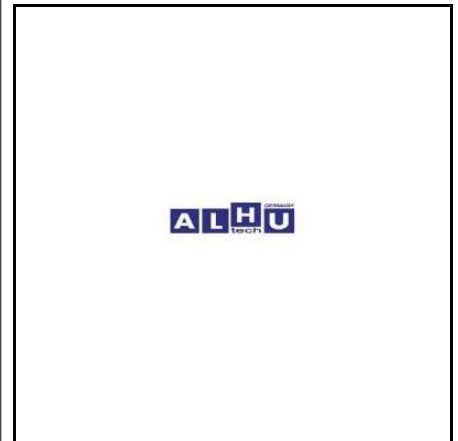

29 255 069 RETARDER SWITCH

MAN
81.25509.0069

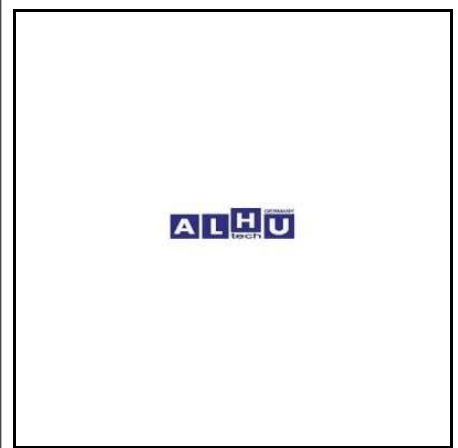

29 255 071 RETARDER SWITCH

MAN
81.25509.0071

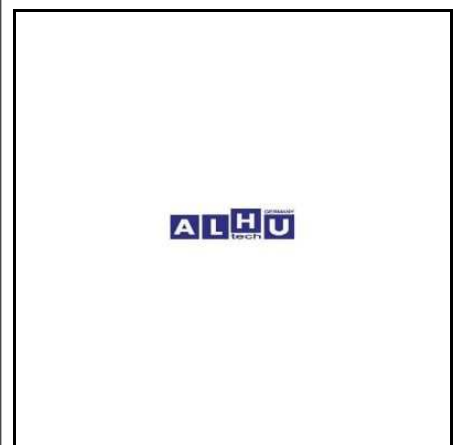

29 255 072 RETARDER SWITCH

MAN
81.25509.0072

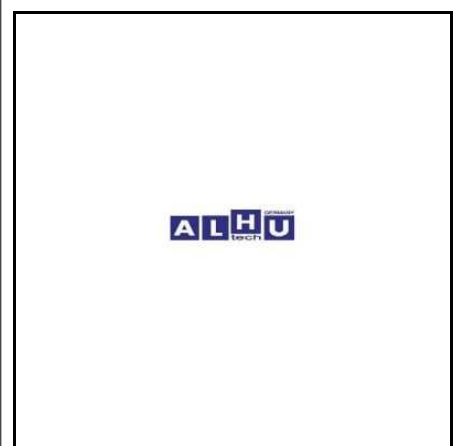

Schalter / Switch

29 255 073 RETARDER SWITCH

MAN
81.25509.0073

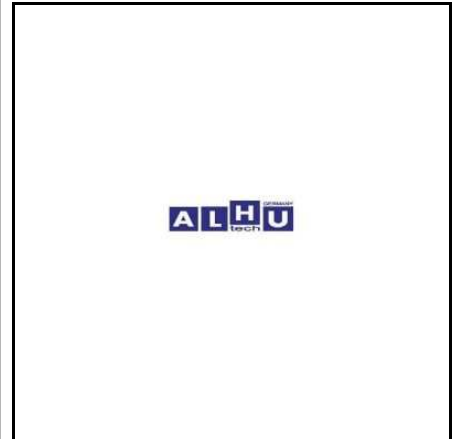

29 255 075 RETARDER SWITCH

MAN
81.25509.0075

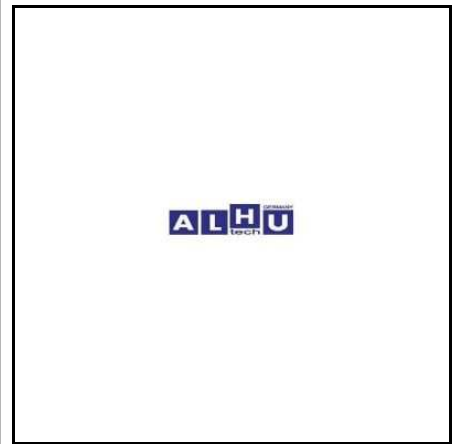

29 255 076 RETARDER SWITCH

MAN
81.25509.0076



29 255 084 RETARDER SWITCH

MAN
81.25509.0084

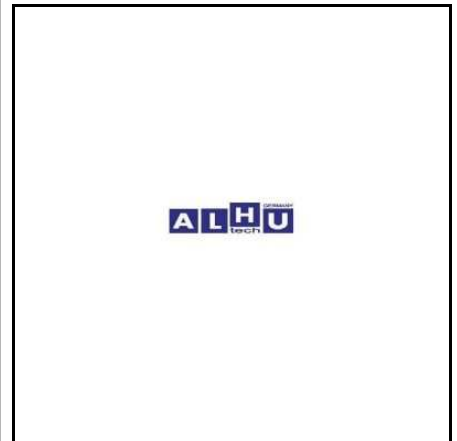

Schalter / Switch

29 255 175 RETARDER SWITCH

MAN
81.25505.6175



JL110007/8006 RETARDER SWITCH



MAN
81.25509.0068



25 545 714 REVERSE LIGHT SWITCH

MAN 81.27421.0056 **ZF** 0501 203 944

Mercedes Benz
001 545 76 14



25 545 814 REVERSE LIGHT SWITCH

F 2000 TGA TGX

MAN 81.25505.0636 **Scania** 1303471 1541086

Mercedes Benz
001 545 47 14



Schalter / Switch

29 525 032 REVERSE LIGHT SWITCH

MAN
81.25525.0032



29 525 033 REVERSE LIGHT SWITCH

TGA TGX TGS

MAN
81.25525.0033
81.25525.0227
81.25525.0257

ZF
0501 210 059
0501 216 474



29 525 156 REVERSE LIGHT SWITCH

TGA TGS TGX

MAN
81.25525.0156

ZF
0501 212 606



29 545 005 REVERSE LIGHT SWITCH

MAN
81.25505.0461



Schalter / Switch

63 451 153 REVERSE LIGHT SWITCH

MAN
81.25507.0015



29 255 959 ROTARY SWITCH

MAN
81.25505.0959



29 255 975 ROTARY SWITCH

MAN
81.25505.0975



29 255 976 ROTARY SWITCH

MAN
81.25505.0976



Schalter / Switch

29 255 089 SENSOR

MAN
81.25520.0089



29 255 169 SENSOR
cabin lock

MAN
81.25520.0169



29 255 172 SENSOR

MAN
81.25520.0172



29 255 173 SENSOR

MAN
81.25520.0173



Schalter / Switch

29 255 204 SENSOR

MAN
81.27421.0204



29 255 214 SENSOR

MAN
81.25520.0214



29 255 276 SENSOR

MAN
81.25520.0176



63 450 746 SENSOR TEMPERATURE



MAN
51.27421.0216

Bosch
0 281 002 655



Schalter / Switch

25 545 006 STARTER SWITCH

MAN 81.25501.6012	Mercedes Benz 000 545 37 13
Bosch 0 342 309 008	



25 226 013 STEERING COLUMN SWITCH

MAN
81.25509.0013

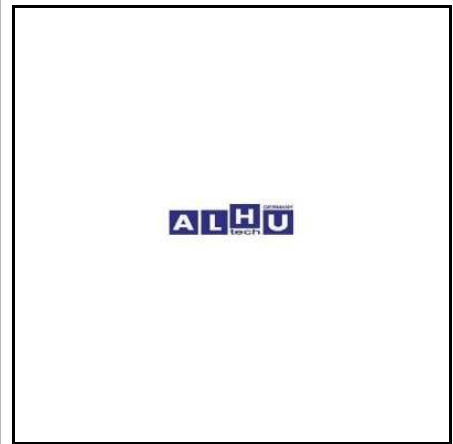

25 226 024 STEERING COLUMN SWITCH

MAN
81.25509.0020

SWF
202.024

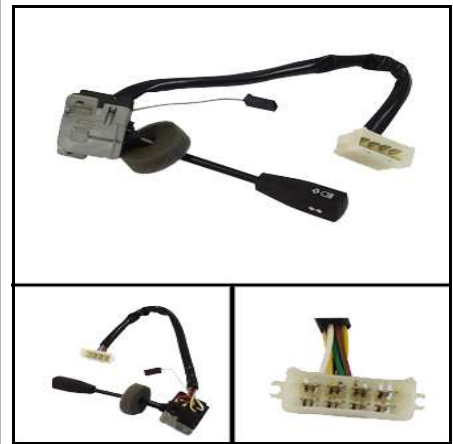

25 226 056 STEERING COLUMN SWITCH

SL 200

MAN
81.25509.6056

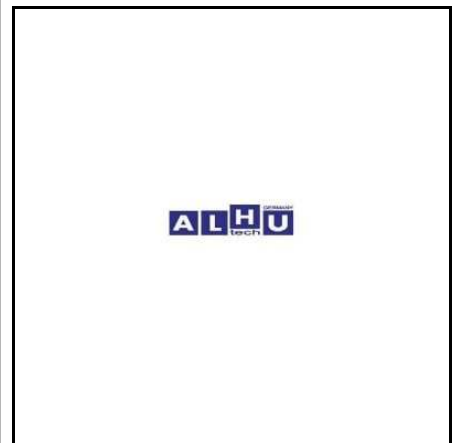

Schalter / Switch

25 226 117 STEERING COLUMN SWITCH

F 2000

MAN
81.25509.0124



25 226 118 STEERING COLUMN SWITCH

TGA

MAN
81.25509.0123
81.25509.0144



25 226 259 STEERING COLUMN SWITCH

SOLARIS

MAN
85.20001.2158



25 226 308 STEERING COLUMN SWITCH

Neoplan
1506.086.00



Schalter / Switch

25 226 468 STEERING COLUMN SWITCH

MAN
81.25505.0468

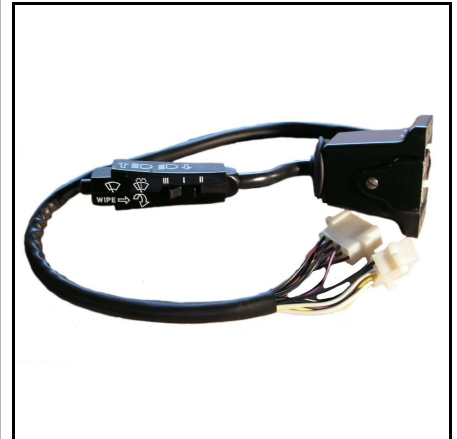

25 226 909 STEERING COLUMN SWITCH

MAN
81.25509.0018



25 226 921 STEERING COLUMN SWITCH

MAN
81.25509.0116

Mercedes Benz
002 540 62 44



29 255 034 STEERING COLUMN SWITCH

MAN
81.25509.0034

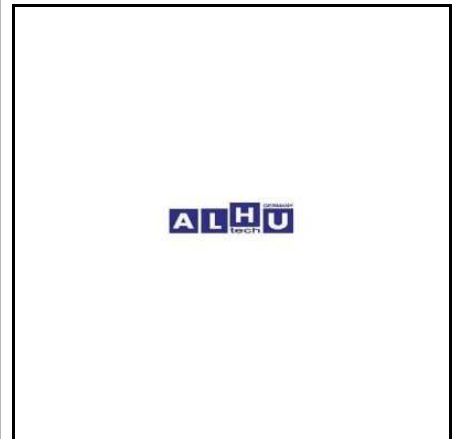

Schalter / Switch

29 255 050 STEERING COLUMN SWITCH

MAN
81.25509.0050



29 255 054 STEERING COLUMN SWITCH

MAN
81.25509.0054



29 255 078 STEERING COLUMN SWITCH

MAN
81.25509.0078



29 255 079 STEERING COLUMN SWITCH

MAN
81.25509.0079



Schalter / Switch

29 255 126 STEERING COLUMN SWITCH

MAN
81.25509.0126



29 255 127 STEERING COLUMN SWITCH

MAN
81.25509.0127



29 255 129 STEERING COLUMN SWITCH

MAN
81.25509.0129



29 255 130 STEERING COLUMN SWITCH

MAN
81.25509.0130

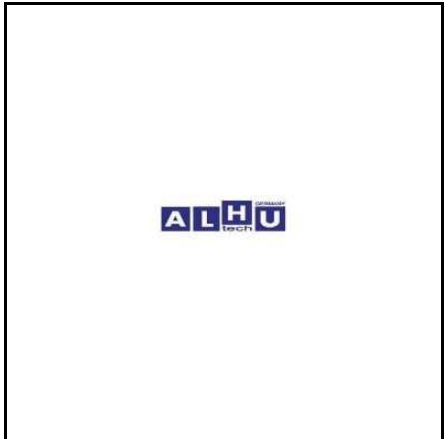

Schalter / Switch

29 255 139 STEERING COLUMN SWITCH

TGA TGS TGX

MAN
81.25509.0139

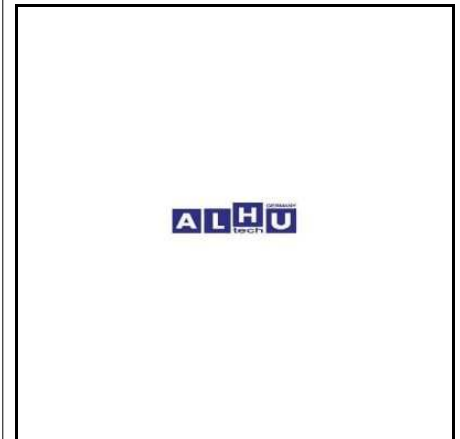

29 255 148 STEERING COLUMN SWITCH

MAN
81.25509.0148

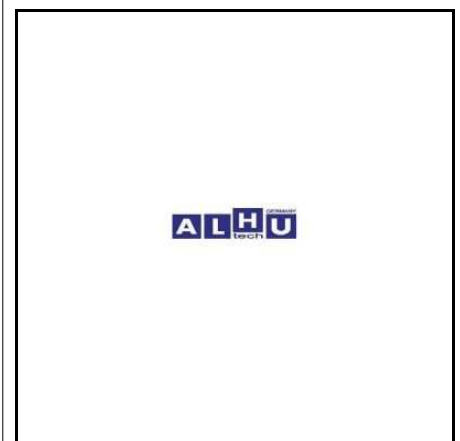

29 255 151 TEMPERATURE SENDER

MAN
51.27421.0151

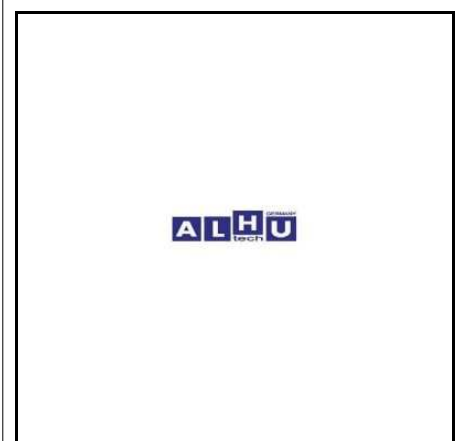

29 545 012 TEMPERATURE SENDER

D 2566 D 0836

MAN
81.27421.0125

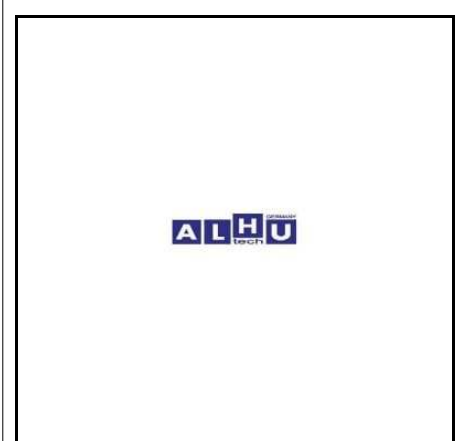

Schalter / Switch

63 450 214 TEMPERATURE SENDER

D 2566 D 2866

MAN
51.27420.7005

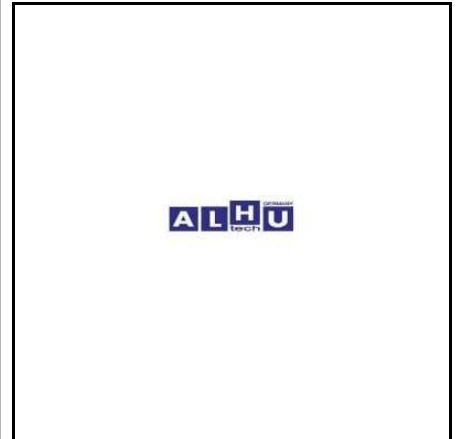

63 450 797 TEMPERATURE SENDER

MAN
51.27421.0132



21 542 917 TEMPERATURE SENSOR

100 degrees

MAN
51.27420.0008

Mercedes Benz
002 542 73 17
003 153 90 28
004 542 56 17



28 421 190 TEMPERATURE SENSOR

MAN
51.27421.0190

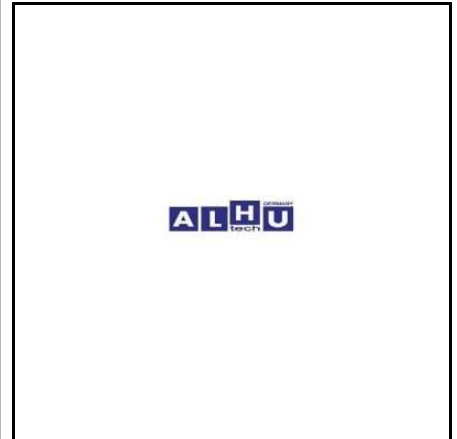

Schalter / Switch

29 421 113 TEMPERATURE SENSOR

MAN
51.27421.0113

Iveco
500306957

Bosch
0 281 002 232

29 421 264 TEMPERATURE SENSOR

TGA TGS TGX

MAN
81.27421.0264

29 545 014 TEMPERATURE SENSOR

MAN
81.27420.0085

26 980 031 TEMPERATURE SWITCH

TGA TGS TGX

MAN
81.61980.6031

Mercedes Benz
000 830 12 72

Behr/Hella
6ZT 351 080-151



Schalter / Switch

25 545 131 TOGGLE SWITCH

MAN
81.25503.6131



25 545 209 TOGGLE SWITCH
door opening

MAN
81.25503.6209



25 545 223 TOGGLE SWITCH
WINDOW LIFTER

MAN
81.25503.0223



25 545 255 TOGGLE SWITCH
LIGHT MASTER

MAN
81.25505.6255



Schalter / Switch

25 545 259	TOGGLE SWITCH
	WARNING LIGHT
MAN	
81.25505.6259	



25 545 260	TOGGLE SWITCH
	FLOODLIGHT
MAN	
81.25505.6260	



25 545 262	TOGGLE SWITCH
	MIRROR HEATING
MAN	
81.25505.6262	



25 545 265	TOGGLE SWITCH
	HORN
MAN	
81.25505.6265	



Schalter / Switch

25 545 267 TOGGLE SWITCH
trailer coupling

MAN
81.25503.6267



25 545 268 TOGGLE SWITCH

MAN
81.25505.6267

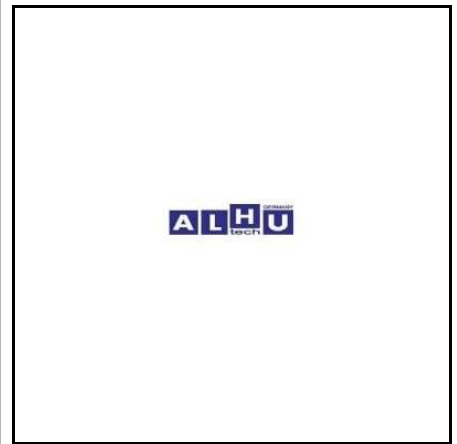

25 545 270 TOGGLE SWITCH
PTO

MAN
81.25505.6270

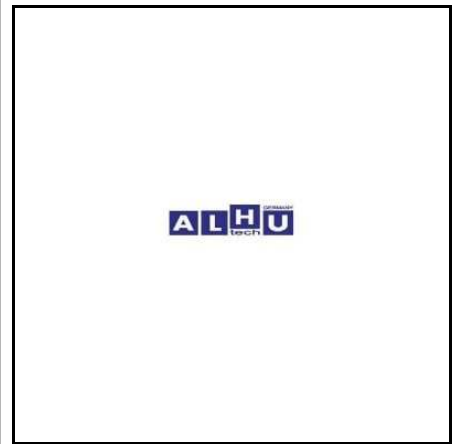

25 545 271 TOGGLE SWITCH
PTO

MAN
81.25505.6271

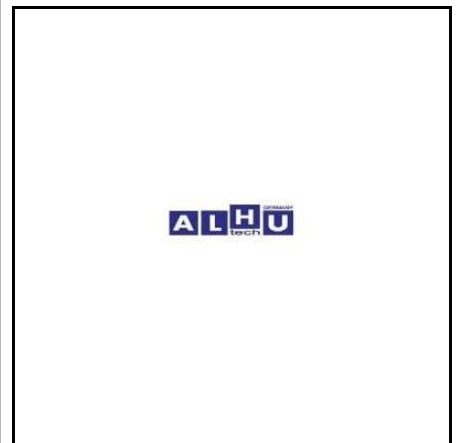

Schalter / Switch

25 545 274 TOGGLE SWITCH
ECAS CONTROL

MAN
81.25505.6274



25 545 280 TOGGLE SWITCH
DIFFERENTIAL LOCK

TGA

MAN
81.25505.6280



25 545 282 TOGGLE SWITCH

MAN
81.25505.6282



25 545 288 TOGGLE SWITCH
ENGINE CONTROL

MAN
81.25505.6288



Schalter / Switch

25 545 291 TOGGLE SWITCH
 WARNING FLASHER

MAN
 81.25505.6291



25 545 292 TOGGLE SWITCH

MAN
 81.25505.6292



25 545 302 TOGGLE SWITCH

MAN
 81.25503.6302



25 545 327 TOGGLE SWITCH
 INTERIOR LIGHTS

MAN
 81.25505.6327



Schalter / Switch

25 545 378 TOGGLE SWITCH

MAN
81.25505.6378

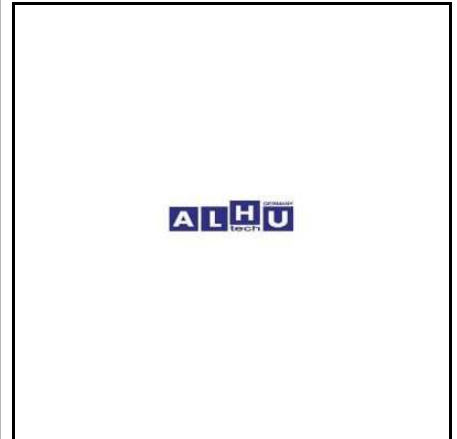

**25 545 607 TOGGLE SWITCH
FOG LAMP**

MAN
81.25505.6607



25 545 909 TOGGLE SWITCH

MAN
81.25503.6300



63 451 128 TOGGLE SWITCH

MAN
81.25505.0668

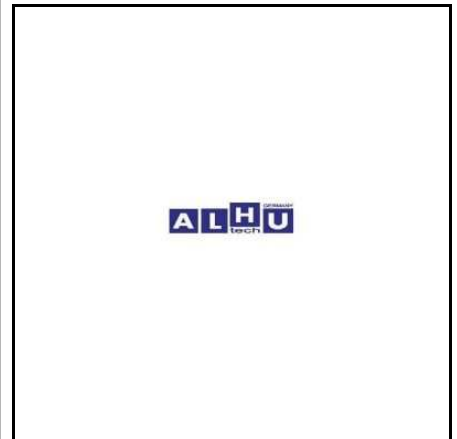

Schalter / Switch

29 943 009 TRANSFORMER 24>12V DC

MAN
81.25943.6009



29 255 231 VACUUM SWITCH

MAN
81.27421.0231



63 450 008 WATER LEVEL SENSOR

MAN
81.27421.0189



63 450 010 WATER LEVEL SENSOR

F 2000

MAN
81.27421.0152



Umschlüsselung / Cross Referenz

AL-HU TECH	MAN	Description	Page
616701	81.35204.0018	THRUST WASHER	79
616702	81.35611.0017	DRIVE SHAFT	25
616705	81.90701.0722	THRUST WASHER	79
616706	81.93020.0678	KING PIN BUSHING	31
616707	81.93020.0679	KING PIN BUSHING	32
616708	81.93021.0218	BUSH	16
616709	81.32510.0013	THRUST PIECE	201
616710	81.32526.0031	SLIDING BLOCK	200
AK27501	81.25503.0222	PUSH KEY	485
AM 16X1.5	06.11241.0317	HEX LOCK NUT	147
CHF11S	09.11003.0427	HYDRAULIC OIL 1 LITRE TIN	152
G 1/2 A	06.08049.0028	DRAIN PLUG DIN 908	146
JL110007/80060238	81.25509.0068	RETARDER SWITCH	488
M10X45	06.02099.0351	CYLINDER SCREW	145
M14X1.5	06.08042.0603	DRAIN PLUG	145
M14X1.5	06.11065.2317	HEXAGON NUT DIN 934	152
06 501 568	81.50202.0127	BRAKE ANCHOR PLATE	118
06.3.02536	51.03201.0088	VALVE GUIDE	453
06.3.25102	51.03201.0102	VALVE GUIDE	454
11.020.0805.191	81.45503.0047	HEX COLLAR NUT, black	30
13 815 004	81.50811.0004	BRAKE WEAR INDICATOR	124
13 815 011	81.50822.6016	BRAKE WEAR INDICATOR KIT	125
13 815 012	81.50822.6017	BRAKE WEAR INDICATOR	124
13 815 013	81.50822.6013	BRAKE WEAR INDICATOR	124
13 815 014	81.50822.6014	BRAKE WEAR INDICATOR KIT	125
13 815 015	81.50822.6015	BRAKE WEAR INDICATOR	124
13 815 015	81.50822.6029	BRAKE WEAR INDICATOR	124
13 815 022	81.25937.6012	BRAKE WEAR INDICATOR	125
13 815 601	81.25937.6011	BRAKE WEAR INDICATOR	125
20 000 013	06.02813.5013	TENSILOCK SCREW	153
20 000 015	06.02815.9015	TENSILOCK SCREW	153
20 000 017	06.02815.9017	TENSILOCK SCREW	154
20 000 022	06.02815.9022	TENSILOCK SCREW	154
20 000 812	06.02815.8812	TENSILOCK SCREW	154
20 000 911	06.02815.8911	TENSILOCK SCREW	154
20 000 912	06.02813.4912	HEX LOCK SCREW	148
20 000 913	06.02815.8913	TENSILOCK SCREW	155
20 000 914	06.02815.8914	TENSILOCK SCREW	155
20 000 915	06.02813.4915	TENSILOCK SCREW	155
20 000 916	06.02813.4916	TENSILOCK SCREW	155
20 000 917	06.02815.8917	TENSILOCK SCREW	156
20 000 919	06.02813.4919	TENSILOCK SCREW	156
20 000 933	06.01494.6933	HEX SHOULDER STUD	150
20 000 935	06.01494.4935	HEX SHOULDER STUD	150
20 000 936	06.01494.6511	HEX SHOULDER STUD 10.9	152
20 001 005	06.11251.2005	FLAT COLLAR NUT	146
20 001 108	06.11251.8108	FLAT COLLAR NUT	146
21 000 009	06.36959.0027	BEARING BUSH	14
21 000 010	81.43407.0102	SPRING PAD	67
21 000 011	81.43407.5003	SPRING PAD	68
21 000 012	81.43722.0087	STABILIZER MOUNTING	68
21 000 013	81.96210.0240	RUBBER MOUNTING	45
21 000 014	85.41715.0006	RUBBER BUSHING	44
21 001 002	06.46113.0370	U-BOLT	85

Umschlüsselung / Cross Referenz

AL-HU TECH	MAN	Description	Page
21 001 003	06.46113.2510	U-BOLT	85
21 001 005	06.46119.0003	U-BOLT	85
21 002 000	06.09019.0032	SPRING BOLT	60
21 002 001	06.09019.0049	SPRING BOLT	61
21 002 002	06.09019.0063	SPRING BOLT	61
21 002 003	06.09019.0095	SPRING BOLT	61
21 003 040	81.26214.0003	ENGAGEMENT ROD	162
21 004 036	81.26204.0013	FIELD COIL	163
21 004 078	81.26204.0032	FIELD COIL	163
21 004 083	81.26204.0033	FIELD COIL	163
21 005 022	81.26203.6018	ARMATURE	159
21 005 023	81.26203.6019	ARMATURE	160
21 005 023	81.26203.6020	ARMATURE	160
21 005 025	81.26203.6007	ARMATURE	160
21 006 020	81.26209.0015	STARTER PINION	171
21 010 020	51.03100.6053	CYLINDER HEAD	354
21 010 120	51.03101.6773	CYLINDER HEAD	354
21 010 172	51.05805.5335	OIL DIPSTICK	415
21 010 181	51.03100.6181	CYLINDER HEAD	354
21 010 183	51.90310.0183	OIL DRAIN PLUG	417
21 010 220	51.03101.6774	CYLINDER HEAD	354
21 010 233	51.01401.6049	TIMING CASE	447
21 010 381	51.90020.0381	CYLINDER HEAD SCREW	355
21 010 414	51.05805.5414	OIL DIPSTICK	415
21 010 472	51.05805.5609	OIL DIPSTICK	416
21 010 682	51.03101.6682	CYLINDER HEAD	355
21 014 052	A5.00024.0938	CARBON BRUSH SET	160
21 014 070	81.25921.6051	CARBON BRUSH SET	160
21 014 079	81.25921.6058	CARBON BRUSH SET	161
21 017 003	51.10108.0003	PRESSURE SCREW	426
21 017 066	51.01601.5066	OIL SPRAYER NOZZLE	424
21 017 067	51.01601.5082	OIL SPRAYER NOZZLE	424
21 017 081	51.01601.5081	OIL SPRAYER NOZZLE	424
21 017 083	51.01601.5083	OIL SPRAYER NOZZLE	424
21 018 006	51.97141.7006	TANK CAP	443
21 018 035	51.01804.7028	OIL SEPERATOR	423
21 018 135	51.01804.7037	OIL SEPERATOR	423
21 018 235	51.01804.7023	OIL SEPERATOR	423
21 018 435	51.01804.7026	OIL SEPERATOR	423
21 018 935	51.01804.7032	OIL SEPARATOR	422
21 030 001	51.04401.5053	CAMSHAFT	343
21 030 019	51.02100.6019	CRANKSHAFT	352
21 030 034	51.02301.6034	FLYWHEEL	392
21 030 043	51.02301.6043	FLYWHEEL	392
21 030 064	51.02201.0064	VIBRATION DAMPER	456
21 030 086	51.02310.0086	FLYWHEEL RING GEAR	396
21 030 087	51.02310.0087	FLYWHEEL RING GEAR	397
21 030 097	51.02310.0097	FLYWHEEL RING GEAR	397
21 030 101	51.04400.6006	CAMSHAFT	344
21 030 120	51.02401.6214	CONROD	348
21 030 182	51.02115.0182	TIMING GEAR - CRANKSHAFT	448
21 030 201	51.02101.6088	CRANKSHAFT	352
21 030 221	51.02400.6049	CONROD	348
21 030 258	51.02301.5258	FLYWHEEL	393

Umschlüsselung / Cross Referenz

AL-HU TECH	MAN	Description	Page
21 030 301	51.02100.6025	CRANKSHAFT	352
21 030 321	51.02301.5121	FLYWHEEL	393
21 030 401	51.02101.6097	CRANKSHAFT	353
21 030 402	51.02301.7295	FLYWHEEL	393
21 030 403	51.02301.7300	FLYWHEEL	393
21 030 421	51.02400.6054	CONROD	348
21 030 439	51.02301.7439	FLYWHEEL	394
21 030 441	51.02301.7410	FLYWHEEL	394
21 030 501	51.02101.6090	CRANKSHAFT	353
21 030 520	51.02401.6234	CONROD	348
21 030 621	51.02400.6066	CONROD	349
21 031 020	51.02400.6044	CONROD	349
21 031 120	51.02400.6023	CONROD	349
21 031 127	51.02130.0032	CRANKSHAFT RACE	353
21 031 420	51.02400.6015	CONROD	349
21 032 309	51.02130.0013	CRANKSHAFT RACE	353
21 040 003	51.12101.7038	FUEL FEED PUMP	397
21 040 003	81.12101.6022	FUEL FEED PUMP	397
21 050 001	51.04401.6290	CAMSHAFT	344
21 050 002	51.04401.6373	CAMSHAFT	344
21 050 003	51.04401.6375	CAMSHAFT	344
21 050 004	51.04401.6148	CAMSHAFT	345
21 050 011	51.04401.6371	CAMSHAFT	345
21 050 025	51.04301.0109	VALVE TAPPET	455
21 050 101	51.04401.6266	CAMSHAFT	345
21 050 111	51.04401.6398	CAMSHAFT	345
21 050 211	51.04401.6382	CAMSHAFT	346
21 050 236	51.04202.5034	ROCKER ARM BRACKET	440
21 054 001	51.04301.0007	VALVE TAPPET	456
21 054 005	51.04302.0066	PUSH ROD	427
21 070 009	51.11160.6009	BOOSTER CYLINDER	341
21 070 167	51.98150.0167	HOLLOW SCREW	406
21 072 112	81.11701.6046	AIR CYLINDER	334
21 074 005	51.10108.0005	PRESSURE SCREW	426
21 074 031	81.10109.0031	NOZZLE CAP NUT	414
21 074 515	51.12505.0004	OVERFLOW VALVE	425
21 090 115	51.12501.7115	FUEL FILTER 2 STAGES	401
21 090 751	51.12503.0050	REPAIR KIT	439
21 090 751	51.12503.0062	REPAIR KIT	439
21 092 000	81.12902.6000	GASKET SET	403
21 092 001	81.12902.6001	GASKET SET	403
21 094 002	81.08301.6281	DRY AIR CLEANER	359
21 094 003	81.08400.6003	DRY AIR CLEANER	358
21 094 004	81.08400.6004	DRY AIR CLEANER	359
21 094 005	81.08401.6169	DRY AIR CLEANER	359
21 094 050	81.08312.0010	DUST EJECTOR VALVE	360
21 094 051	81.08303.6051	FILTER HOUSING	391
21 094 083	81.96301.0624	TURBO HOSE	448
21 094 126	81.96320.0126	TURBO HOSE	449
21 094 182	81.96320.0168	TURBO HOSE	449
21 094 482	81.96320.0175	TURBO HOSE	449
21 094 513	81.96320.0162	INTERCOOLER HOSE	412
21 094 582	81.96301.0587	INTERCOOLER HOSE	413
21 094 782	81.96301.0600	TURBO HOSE	449

Umschlüsselung / Cross Referenz

AL-HU TECH	MAN	Description	Page
21 094 783	51.96330.0359	TURBO HOSE	450
21 094 882	81.96301.0900	TURBO HOSE	450
21 094 883	81.96301.0594	TURBO HOSE	450
21 094 982	81.96301.0590	TURBO HOSE	450
21 095 001	81.96301.0622	RADIATOR HOSE	429
21 095 002	81.96301.0894	RADIATOR HOSE	429
21 095 003	81.96301.0895	RADIATOR HOSE	430
21 095 004	81.96301.0896	RADIATOR HOSE	430
21 095 005	81.96301.0904	RADIATOR HOSE	430
21 095 006	81.96301.0906	RADIATOR HOSE	430
21 095 007	81.96305.0166	RADIATOR HOSE	431
21 095 008	81.96305.0192	RADIATOR HOSE	431
21 095 009	81.96305.0197	RADIATOR HOSE	431
21 095 010	81.96305.0200	RADIATOR HOSE	431
21 095 011	81.96305.0217	HEATER HOSE	404
21 095 012	81.96305.0235	HEATER HOSE	404
21 095 013	81.96305.0262	HEATER HOSE	405
21 095 014	81.96305.0272	HEATER HOSE	405
21 095 015	81.96305.0304	RADIATOR HOSE	432
21 095 082	81.96320.0132	TURBO HOSE	451
21 095 382	81.96320.0159	TURBO HOSE	451
21 095 482	81.96301.0648	TURBO HOSE	451
21 095 582	81.96301.0387	TURBO HOSE	451
21 095 682	81.96305.0207	RADIATOR HOSE	432
21 095 782	81.96305.0312	RADIATOR HOSE	432
21 098 118	51.09402.0118	BELLOW	336
21 098 188	51.09402.0188	BELLOW	336
21 098 242	81.96420.0242	BELLOW	337
21 101 006	81.26212.0011	SOLENOID SWITCH	168
21 114 086	81.35114.0086	HUB CAP	31
21 115 567	81.39115.5067	DRIVING FLANGE	25
21 130 002	51.54116.0002	AIR COMPRESSOR SUCTION DISC	114
21 130 003	51.54100.7003	AIR COMPRESSOR	98
21 130 004	81.54122.6004	AIR COMPRESSOR PRESSURE VALVE	112
21 130 005	51.54124.6004	AIR COMPRESSOR LAMELLA	110
21 130 006	81.54901.6006	AIR COMPRESSOR GASKET SET	108
21 130 007	51.54100.6007	AIR COMPRESSOR	98
21 130 007	51.54100.9007	AIR COMPRESSOR	98
21 130 008	51.54105.6006	AIR COMPRESSOR PISTON ASSEMBLY	111
21 130 009	51.54100.6001	AIR COMPRESSOR	98
21 130 010	81.54901.6007	AIR COMPRESSOR GASKET SET	109
21 130 011	51.54124.6003	AIR COMPRESSOR REPAIR KIT	112
21 130 015	51.54100.6015	AIR COMPRESSOR	99
21 130 016	51.54101.7247	AIR COMPRESSOR	99
21 130 019	51.54114.6054	AIR COMPRESSOR CYLINDER HEAD	105
21 130 021	51.54105.6021	AIR COMPRESSOR CYLINDER HEAD	105
21 130 023	81.54124.6023	AIR COMPRESSOR REPAIR KIT	112
21 130 024	51.54210.0038	AIR COMPRESSOR GEAR	109
21 130 025	81.54106.0006	AIR COMPRESSOR CONROD	102
21 130 027	51.54103.0002	AIR COMPRESSOR PISTON RING	111
21 130 030	51.54112.6030	AIR COMPRESSOR HOUSING	109
21 130 033	81.54113.0038	AIR COMPRESSOR CRANKSHAFT	103
21 130 034	51.54901.0034	AIR COMPRESSOR GASKET	107
21 130 035	51.54901.0035	AIR COMPRESSOR GASKET	107

Umschlüsselung / Cross Referenz

AL-HU TECH	MAN	Description	Page
21 130 038	81.54105.0024	AIR COMPRESSOR CYLINDER	104
21 130 039	81.54106.0013	AIR COMPRESSOR CONROD	102
21 130 040	81.54113.0036	AIR COMPRESSOR CRANKSHAFT	103
21 130 042	51.54901.0042	AIR COMPRESSOR GASKET	108
21 130 043	81.54114.0022	AIR COMPRESSOR CYLINDER	104
21 130 044	51.54113.5044	AIR COMPRESSOR CRANKSHAFT	103
21 130 045	51.54130.6011	AIR COMPRESSOR FLANGE	106
21 130 046	81.54901.0094	AIR COMPRESSOR GASKET	108
21 130 047	51.54000.7112	AIR COMPRESSOR	99
21 130 048	81.54124.6013	AIR COMPRESSOR FLAP VALVE KIT	107
21 130 049	51.54100.6049	AIR COMPRESSOR REPAIR KIT	113
21 130 050	81.54124.6019	AIR COMPRESSOR FLAP VALVE KIT	107
21 130 051	51.90020.0131	AIR COMPRESSOR CRANKSHAFT SCRE	104
21 130 058	51.54000.7058	AIR COMPRESSOR	99
21 130 063	51.54000.7063	AIR COMPRESSOR	100
21 130 064	81.54101.6055	AIR COMPRESSOR REPAIR KIT	113
21 130 065	51.54000.7128	AIR COMPRESSOR	100
21 130 073	51.54114.6073	AIR COMPRESSOR CYLINDER HEAD	105
21 130 079	51.54000.7079	AIR COMPRESSOR	100
21 130 081	51.54114.6081	AIR COMPRESSOR CYLINDER HEAD	105
21 130 084	51.54114.6084	AIR COMPRESSOR CYLINDER HEAD	106
21 130 110	51.54112.6020	AIR COMPRESSOR HOUSING	110
21 130 121	51.54100.7121	AIR COMPRESSOR	100
21 130 129	51.54000.7129	AIR COMPRESSOR	101
21 130 132	81.54124.0005	AIR COMPRESSOR REPAIR KIT	113
21 130 141	51.54210.0141	AIR COMPRESSOR DRIVE GEAR	106
21 130 182	51.54210.0182	AIR COMPRESSOR DRIVE GEAR	106
21 130 608	51.54105.6008	AIR COMPRESSOR PISTON ASSEMBLY	111
21 130 816	51.54106.6013	AIR COMPRESSOR CONROD	102
21 131 001	51.54103.0001	AIR COMPRESSOR PISTON RING	111
21 131 011	81.54130.0011	AIR COMPRESSOR BUSHING	101
21 131 016	51.54113.0017	AIR COMPRESSOR CRANKSHAFT	103
21 131 021	51.54130.6021	AIR COMPRESSOR BEARING FLANGE	101
21 131 042	51.54100.6042	AIR COMPRESSOR REPAIR KIT	113
21 131 108	51.54210.0108	AIR COMPRESSOR GEAR	109
21 131 116	51.54113.5027	AIR COMPRESSOR CRANKSHAFT	104
21 132 002	51.54119.6001	AIR COMPRESSOR PISTON	110
21 132 009	51.54119.6009	AIR COMPRESSOR PISTON RING	112
21 140 026	81.15601.6057	EXHAUST THROTTLE	376
21 140 029	51.90490.0029	SCREW, EXHAUST MANIFOLD	440
21 140 030	51.90490.0030	SCREW, EXHAUST MANIFOLD	441
21 140 056	81.15600.6081	EXHAUST THROTTLE	376
21 140 056	81.15601.0022	EXHAUST THROTTLE	376
21 140 067	51.90001.0167	EXHAUST MANIFOLD BOLT	371
21 140 073	51.90201.0173	STUD	443
21 140 076	81.15600.6106	EXHAUST THROTTLE	376
21 140 082	51.98701.0082	MULTIPIECE OIL RING	413
21 140 085	51.98701.0085	MULTIPIECE OIL RING	413
21 140 144	81.95301.6144	BALL JOINT	174
21 140 169	51.90001.0169	EXHAUST MANIFOLD BOLT	371
21 140 455	81.15701.6120	AIR CYLINDER	334
21 140 457	81.15701.6079	AIR CYLINDER	334
21 140 458	81.15701.6093	AIR CYLINDER	335
21 140 460	81.15701.6112	AIR CYLINDER	335

Umschlüsselung / Cross Referenz

AL-HU TECH	MAN	Description	Page
21 144 122	51.25601.0006	VOLTAGE REGULATOR	172
21 146 050	81.06110.0026	RADIATOR CAP	428
21 146 350	81.06111.0018	RADIATOR CAP	428
21 146 351	81.06111.0020	RADIATOR CAP	428
21 146 352	81.12210.6025	TANK CAP	444
21 146 353	81.12210.6027	TANK CAP	444
21 146 354	81.15402.6027	TANK CAP	444
21 180 115	51.05405.5024	OIL PRESSURE VALVE	420
21 180 438	51.05503.6006	OIL FILTER HEAD	418
21 180 501	51.05100.6279	OIL PUMP	421
21 180 701	51.05100.6133	OIL PUMP	422
21 180 801	51.05100.6135	OIL PUMP	422
21 184 002	51.05505.6002	COVER	351
21 188 001	51.05601.0121	OIL COOLER	414
21 192 005	81.25601.0011	VOLTAGE REGULATOR	172
21 192 014	81.25601.6030	VOLTAGE REGULATOR	172
21 200 002	81.06630.6072	FAN CLUTCH	384
21 200 005	51.06604.0061	FAN CLUTCH ADAPTOR	390
21 200 006	51.06601.0243	FAN CLUTCH	384
21 200 011	51.06500.6495	WATER PUMP	462
21 200 021	51.06405.0021	THERMOSTAT COVER	445
21 200 026	51.06600.7033	FAN CLUTCH	384
21 200 027	51.06601.0279	FAN BLADE	379
21 200 028	51.06601.0250	FAN BLADE	379
21 200 032	51.06601.0233	FAN BLADE	380
21 200 036	51.06500.6228	WATER PUMP	462
21 200 037	51.06630.0037	FAN CLUTCH	385
21 200 037	51.06630.0043	FAN CLUTCH	385
21 200 039	51.95820.0039	V-BELT PULLEY	457
21 200 045	51.06404.0067	THERMOSTAT HOUSING	445
21 200 060	51.06630.0060	FAN CLUTCH	385
21 200 066	51.06630.0066	FAN CLUTCH	385
21 200 067	51.06630.0067	FAN CLUTCH	385
21 200 068	51.06630.0068	FAN CLUTCH	386
21 200 072	51.06630.0072	FAN CLUTCH	386
21 200 074	51.06630.0074	FAN CLUTCH	386
21 200 075	51.95800.6075	BELT TENSIONER PULLEY	339
21 200 075	51.95800.6107	BELT TENSIONER PULLEY	339
21 200 076	51.95800.6092	BELT TENSIONER PULLEY	340
21 200 076	51.95800.6099	BELT TENSIONER PULLEY	340
21 200 077	51.06630.0077	FAN CLUTCH	386
21 200 079	51.06503.0122	V-BELT PULLEY	458
21 200 080	51.06503.0123	V-BELT PULLEY	458
21 200 081	51.93410.0116	WATER PUMP BEARING	467
21 200 086	51.06500.6646	WATER PUMP	462
21 200 086	51.06500.6676	WATER PUMP	462
21 200 087	51.06500.6472	WATER PUMP	462
21 200 088	51.95800.7396	BELT TENSIONER	337
21 200 089	51.95800.7437	BELT TENSIONER	338
21 200 090	51.97601.0290	PRESSURE SPRING	427
21 200 092	51.06601.0227	FAN CLUTCH	387
21 200 093	51.06630.0071	FAN CLUTCH	387
21 200 094	51.06630.0119	FAN CLUTCH	387
21 200 095	51.06600.7046	FAN CLUTCH	387

Umschlüsselung / Cross Referenz

AL-HU TECH	MAN	Description	Page
21 200 096	51.06600.7015	FAN CLUTCH	388
21 200 096	51.06600.7045	FAN CLUTCH	388
21 200 100	51.06500.6680	WATER PUMP	463
21 200 100	51.06500.9680	WATER PUMP	463
21 200 101	51.06500.6537	WATER PUMP	463
21 200 101	51.06500.9537	WATER PUMP	463
21 200 104	51.95800.7397	BELT TENSIONER	338
21 200 105	51.06500.6679	WATER PUMP	463
21 200 105	51.06500.9679	WATER PUMP	463
21 200 107	51.06630.0131	FAN CLUTCH	388
21 200 111	51.06500.6476	WATER PUMP	463
21 200 112	51.06630.0112	FAN CLUTCH	388
21 200 115	51.06630.0115	FAN CLUTCH	388
21 200 129	51.06630.0129	FAN CLUTCH	389
21 200 130	51.06630.0130	FAN CLUTCH	389
21 200 237	51.06503.0237	V-BELT PULLEY	458
21 200 258	51.06601.0258	FAN BLADE	380
21 200 268	51.06601.0268	FAN BLADE	380
21 200 301	51.06500.6492	WATER PUMP	464
21 200 301	51.06500.9492	WATER PUMP	464
21 200 325	51.06503.0325	V-BELT PULLEY	458
21 200 431	51.95800.7431	BELT TENSIONER PULLEY	340
21 200 435	51.95800.7435	BELT TENSIONER	338
21 200 435	51.95800.7480	BELT TENSIONER	338
21 200 459	51.95800.7459	BELT TENSIONER	338
21 200 501	51.06500.6479	WATER PUMP	464
21 200 515	51.06500.6515	WATER PUMP	464
21 200 547	51.06500.6547	WATER PUMP	464
21 200 580	51.95800.7315	BELT TENSIONER	339
21 200 601	51.06500.6426	WATER PUMP	465
21 200 676	51.06500.7049	WATER PUMP	465
21 200 676	51.06500.9049	WATER PUMP	465
21 200 701	51.06500.6606	WATER PUMP	465
21 200 701	51.06500.6612	WATER PUMP	465
21 200 701	51.06500.6669	WATER PUMP	465
21 200 701	51.06500.9612	WATER PUMP	465
21 200 801	51.06500.6546	WATER PUMP	465
21 200 801	51.06500.9546	WATER PUMP	465
21 200 903	51.06500.6548	WATER PUMP	466
21 200 904	51.06500.6480	WATER PUMP	466
21 200 905	51.06500.6543	WATER PUMP	466
21 200 905	51.06500.6569	WATER PUMP	466
21 200 966	51.06500.7066	WATER PUMP	466
21 200 966	51.06500.7089	WATER PUMP	466
21 200 966	51.06500.9066	WATER PUMP	466
21 201 039	81.06630.6039	FAN CLUTCH	389
21 201 047	51.06630.0047	FAN CLUTCH	389
21 203 001	51.10303.6177	INJECTION LINE SET	408
21 203 002	51.10303.6115	INJECTION LINE SET	408
21 203 003	51.10300.6023	INJECTION LINE SET	409
21 203 008	51.06303.5351	COOLING WATER LINE	350
21 203 009	06.54099.0124	HOSE PIPE	130
21 203 010	06.54099.0121	HOSE PIPE	255
21 203 012	06.54100.4370	CLUTCH HOSE	179

Umschlüsselung / Cross Referenz

AL-HU TECH	MAN	Description	Page
21 203 013	51.10300.6032	INJECTION LINE SET	409
21 203 016	51.10303.6191	INJECTION LINE SET	409
21 203 017	51.10303.6144	INJECTION LINE SET	409
21 203 018	51.10303.6025	INJECTION LINE SET	410
21 203 019	51.10301.6176	INJECTION LINE SET	410
21 203 020	51.10301.6177	INJECTION LINE SET	410
21 203 021	51.10303.6159	INJECTION LINE SET	410
21 203 022	51.10300.6029	INJECTION LINE	408
21 203 023	51.97401.6064	CLAMP INJECTION LINE	347
21 203 024	51.97401.6065	CLAMP INJECTION LINE	347
21 203 025	51.97401.6066	CLAMP INJECTION LINE	347
21 203 026	51.10302.6025	COMPRESSOR HOSE	347
21 203 031	51.10303.6220	INJECTION LINE SET	411
21 203 115	51.06302.5115	COOLING WATER LINE	351
21 203 524	51.06302.5524	BREATHER TUBE	343
21 203 680	51.06301.5680	COOLING WATER PIPE	351
21 204 071	51.06402.0065	THERMOSTAT 71 DEGREES	446
21 204 079	51.06402.0061	THERMOSTAT 79 DEGREES	446
21 204 083	51.06402.0060	THERMOSTAT 83 DEGREES	446
21 204 083	51.06402.0063	THERMOSTAT 83 DEGREES	446
21 205 002	51.06601.0263	FAN BLADE	380
21 205 003	51.06601.0264	FAN BLADE	381
21 205 004	51.06601.0178	FAN BLADE	381
21 205 005	51.06601.0266	FAN BLADE	381
21 205 102	51.06601.0102	FAN BLADE	381
21 205 107	51.06601.0107	FAN BLADE	382
21 205 172	51.06601.0172	FAN BLADE	382
21 205 200	51.06601.0200	FAN BLADE	382
21 205 230	51.06601.0230	FAN BLADE	382
21 205 256	51.06601.0256	FAN BLADE	383
21 205 257	51.06601.0257	FAN BLADE	383
21 205 265	51.06601.0265	FAN BLADE	383
21 205 275	51.06601.0275	FAN BLADE	383
21 205 279	51.06503.0279	V-BELT PULLEY	459
21 205 659	81.96101.0659	RADIATOR RUBBER	438
21 209 422	81.26209.0016	STARTER PINION	171
21 210 552	81.96210.0552	ENGINE MOUNTING	26
21 215 001	81.44215.0016	THRUST WASHER	80
21 231 030	51.26201.7213	STARTER MOTOR	169
21 231 030	51.26201.9213	STARTER MOTOR	169
21 240 001	88.43704.0002	RUBBER MOUNTING	45
21 240 002	81.96210.0096	RUBBER MOUNTING	440
21 241 202	81.96020.0202	ENGINE MOUNTING	27
21 241 235	81.96020.0235	ENGINE MOUNTING	360
21 241 340	81.96020.0340	ENGINE MOUNTING	360
21 241 341	81.96020.0341	ENGINE MOUNTING	360
21 241 373	81.96210.0373	ENGINE MOUNTING	27
21 241 382	81.96020.0382	ENGINE MOUNTING	361
21 241 384	81.96020.0384	ENGINE MOUNTING	361
21 241 386	81.96020.0386	ENGINE MOUNTING	361
21 241 402	81.96020.0402	ENGINE MOUNTING	361
21 241 403	81.96020.0403	ENGINE MOUNTING	362
21 250 002	81.30550.0117	CLUTCH RELEASE BEARING	182
21 250 007	81.32411.0007	CLUTCH RELEASE LEVER	184

Umschlüsselung / Cross Referenz

AL-HU TECH	MAN	Description	Page
21 250 019	81.30560.6019	CLUTCH FORK REPAIR KIT	179
21 250 043	81.95302.0044	BALL JOINT	174
21 250 050	81.30560.0050	CLUTCH OPERATING LEVER	182
21 250 063	81.30560.0063	CLUTCH RELEASE LEVER	185
21 250 082	81.30550.0082	CLUTCH RELEASE BEARING	182
21 250 085	81.30550.0085	CLUTCH RELEASE BEARING	183
21 250 105	81.30550.0105	CLUTCH RELEASE BEARING	183
21 250 109	81.30550.0116	CLUTCH RELEASE BEARING	183
21 250 110	81.30550.0110	CLUTCH RELEASE BEARING	183
21 250 115	81.30715.6115	CLUTCH MASTER CYLINDER	180
21 252 646	81.30300.6002	CLUTCH REPAIR KIT	185
21 252 646	81.30300.6003	CLUTCH REPAIR KIT	185
21 255 002	81.32404.0002	BEARING BRACKET	175
21 255 055	81.30560.0055	CLUTCH PIVOT	182
21 271 008	51.27120.0008	SPEED SENSOR	139
21 271 009	51.27120.0009	SPEED SENSOR	140
21 271 014	51.27120.0014	SPEED SENSOR	140
21 271 015	51.27120.0015	SPEED SENSOR	140
21 290 011	81.30715.6040	CLUTCH MASTER CYLINDER	180
21 290 051	81.30715.6051	CLUTCH MASTER CYLINDER	180
21 290 113	81.30715.6113	CLUTCH CYLINDER REPAIR KIT	178
21 290 116	81.30715.6116	CLUTCH MASTER CYLINDER	180
21 290 118	81.30715.6118	CLUTCH CYLINDER REPAIR KIT	179
21 290 119	81.30715.6119	CLUTCH MASTER CYLINDER	181
21 290 120	81.30715.6120	CLUTCH MASTER CYLINDER	181
21 290 135	81.30715.6135	CLUTCH MASTER CYLINDER	181
21 300 159	81.95501.6481	BOWDEN CABLE	341
21 300 261	81.95501.6261	BOWDEN CABLE	341
21 300 359	81.95501.6487	BOWDEN CABLE	342
21 300 367	81.95501.6367	BOWDEN CABLE	342
21 300 459	81.95501.6459	BOWDEN CABLE	342
21 300 537	81.95501.6537	BOWDEN CABLE	342
21 301 015	81.93020.0427	STARTER SHAFT BUSHING	171
21 301 016	81.93020.0428	STARTER SHAFT BUSHING	171
21 302 021	81.41302.0021	WASHER	87
21 311 301	81.25601.6035	VOLTAGE REGULATOR	172
21 311 558	81.25601.0025	VOLTAGE REGULATOR	173
21 325 500	51.26101.7266	ALTERNATOR	157
21 325 500	51.26101.9266	ALTERNATOR	157
21 330 001	81.36305.6004	KING PIN SET	32
21 330 004	81.44205.6010	KING PIN SET	32
21 330 005	81.44205.6011	KING PIN SET	32
21 330 006	81.44205.6012	KING PIN SET	33
21 330 007	81.44205.6019	KING PIN SET	33
21 330 008	81.44205.6020	KING PIN SET	33
21 330 033	81.44205.6033	KING PIN SET	33
21 330 346	51.96330.0346	TURBO HOSE	452
21 334 025	81.44312.0003	HUB CAP	31
21 336 062	81.90711.0890	THRUST WASHER	80
21 350 001	82.52102.0013	AIR DRYER CARTRIDGE	115
21 350 003	81.52108.6025	AIR DRYER CARTRIDGE	115
21 350 008	81.52102.6146	AIR DRYER CARTRIDGE	116
21 350 445	81.39115.5030	FLANGE	29
21 353 126	81.90620.0047	NUT	38

Umschlüsselung / Cross Referenz

AL-HU TECH	MAN	Description	Page
21 353 925	81.90685.0053	THREADED RING	79
21 356 008	81.44301.0169	WHEEL HUB	88
21 356 009	81.35701.0155	WHEEL HUB	88
21 356 010	81.35701.0159	WHEEL HUB	88
21 356 011	81.44301.0107	WHEEL HUB	89
21 356 012	81.44301.0146	WHEEL HUB	89
21 356 013	81.36501.0091	WHEEL HUB	89
21 356 014	81.44301.0179	WHEEL HUB	89
21 356 019	81.44301.0174	WHEEL HUB	90
21 356 020	81.44301.0182	WHEEL HUB	90
21 356 035	81.44301.0177	WHEEL HUB	90
21 356 037	81.36501.0107	WHEEL HUB	90
21 356 038	81.35701.0146	WHEEL HUB	91
21 356 039	81.35701.0147	WHEEL HUB	91
21 401 019	06.32489.0051	BALL BEARING	4
21 401 527	81.26225.6003	STARTER CLUTCH	169
21 410 003	81.39460.0003	THREADED ROD	79
21 410 004	81.39126.6020	UNIVERSAL JOINT	82
21 416 022	51.26201.7112	STARTER MOTOR	169
21 416 024	51.26201.7074	STARTER MOTOR	170
21 417 001	51.26201.7123	STARTER MOTOR	170
21 430 826	88.15701.6003	AIR CYLINDER	335
21 431 002	51.26201.7159	STARTER MOTOR	170
21 440 002	51.12101.7101	FUEL FEED PUMP	397
21 440 007	51.12150.7022	FUEL FEED PUMP	398
21 440 040	51.12101.7019	FUEL FEED PUMP	398
21 440 084	51.12101.7106	FUEL FEED PUMP	398
21 440 089	51.12101.7121	FUEL FEED PUMP	399
21 440 092	51.12101.7107	FUEL FEED PUMP	399
21 440 171	51.12101.7099	FUEL FEED PUMP	399
21 440 174	51.12101.7102	FUEL FEED PUMP	399
21 440 177	51.12101.7034	FUEL FEED PUMP	400
21 440 183	51.12101.7035	FUEL FEED PUMP	400
21 440 245	51.12101.7039	FUEL FEED PUMP	400
21 440 998	51.12101.7040	FUEL FEED PUMP	400
21 447 000	51.12150.7002	HAND PUMP	404
21 447 017	81.11101.6012	REPAIR KIT	439
21 447 032	81.11101.6151	REPAIR KIT	439
21 447 033	81.12150.6013	HAND PUMP	404
21 450 001	81.26212.0012	SOLENOID SWITCH	168
21 450 001	81.26212.0017	SOLENOID SWITCH	168
21 460 047	81.47301.6047	OIL RESERVOIR	327
21 460 136	81.47101.6136	STEERING PUMP	329
21 460 137	81.47101.6137	STEERING PUMP	329
21 460 189	81.47101.6189	STEERING PUMP	329
21 460 502	81.47301.6030	OIL RESERVOIR	327
21 466 068	81.47302.0011	COVER	321
21 466 267	81.47303.0045	OIL DIPSTICK	327
21 468 053	51.26101.7192	ALTERNATOR	157
21 468 137	51.90441.0137	EYE BOLT	378
21 469 982	51.26101.7201	ALTERNATOR	157
21 470 001	81.12503.0085	WATER SEPERATOR FILTER	468
21 470 001	81.12503.0086	WATER SEPERATOR FILTER	468
21 470 002	81.12501.0022	WATER SEPERATOR FILTER	468

Umschlüsselung / Cross Referenz

AL-HU TECH	MAN	Description	Page
21 470 002	81.12503.0080	WATER SEPERATOR FILTER	468
21 470 002	85.12501.0002	WATER SEPERATOR FILTER	468
21 470 002	85.12501.0003	WATER SEPERATOR FILTER	468
21 470 004	51.12503.6000	WATER SEPARATOR FILTER	467
21 470 006	81.06668.0006	HYDRAULIC OIL FILTER	190
21 470 007	51.08301.0016	AIR CLEANER	334
21 470 046	81.33901.6046	GEARBOX OIL FILTER	188
21 488 291	51.26101.7215	ALTERNATOR	157
21 489 728	51.26101.7148	ALTERNATOR	158
21 490 004	81.15210.5004	EXHAUST METAL HOSE	372
21 490 008	81.15210.5008	EXHAUST METAL HOSE	372
21 490 017	81.15210.0017	EXHAUST METAL HOSE	372
21 490 022	81.15210.0022	EXHAUST METAL HOSE	373
21 490 033	81.15210.0033	EXHAUST METAL HOSE	373
21 490 054	81.15210.0054	EXHAUST METAL HOSE	373
21 490 056	81.15210.0056	EXHAUST METAL HOSE	373
21 490 064	81.15210.0064	EXHAUST METAL HOSE	374
21 490 071	81.15210.0071	EXHAUST METAL HOSE	374
21 490 074	81.15210.0074	EXHAUST METAL HOSE	374
21 490 078	81.15210.0078	EXHAUST METAL HOSE	374
21 490 084	81.15210.0084	EXHAUST METAL HOSE	375
21 490 086	81.15210.0086	EXHAUST METAL HOSE	375
21 491 120	81.15502.5120	EXHAUST BRACKET	364
21 499 390	81.15210.0049	EXHAUST METAL HOSE	375
21 500 047	81.06102.6203	EXPANSION TANK	376
21 500 048	81.06102.6204	EXPANSION TANK	377
21 500 052	81.96210.0052	RADIATOR MOUNTING	437
21 500 088	81.96305.0088	RADIATOR HOSE	432
21 500 101	81.96210.0101	RADIATOR MOUNTING	437
21 500 134	81.96305.0134	TURBO HOSE	452
21 500 153	81.96210.0153	EXHAUST MOUNTING	375
21 500 248	81.96210.0248	RADIATOR MOUNTING	437
21 500 426	81.96210.0426	RADIATOR MOUNTING	437
21 500 449	81.06102.6209	EXPANSION TANK	377
21 500 549	81.06102.6201	EXPANSION TANK	377
21 500 549	81.06102.6202	EXPANSION TANK	377
21 500 549	81.06102.6218	EXPANSION TANK	377
21 500 659	81.96301.0659	RADIATOR HOSE	433
21 500 659	82.96301.0011	RADIATOR HOSE	433
21 500 677	81.96301.0677	RADIATOR HOSE	433
21 500 749	81.06102.6118	EXPANSION TANK	377
21 500 949	81.06102.6208	EXPANSION TANK	378
21 501 129	81.96305.0129	RADIATOR HOSE	433
21 501 581	81.96301.0581	RADIATOR HOSE	433
21 501 639	81.96301.0639	REDUCING SLEEVE	438
21 501 898	81.96301.0898	RADIATOR HOSE	434
21 503 333	81.96503.0333	OIL SEAL	38
21 524 005	81.52403.6005	ABS PULSE WHEEL	2
21 525 501	51.26101.7265	ALTERNATOR	158
21 525 501	51.26101.9265	ALTERNATOR	158
21 527 022	81.32527.0022	DOUBLE GROOVED RING	188
21 528 519	81.96420.0519	BELLOW	337
21 541 058	81.41860.0058	BATTERY COVER	204
21 541 090	81.41860.6090	BATTERY COVER	204

Umschlüsselung / Cross Referenz

AL-HU TECH	MAN	Description	Page
21 542 917	51.27420.0008	TEMPERATURE SENSOR	499
21 545 008	81.25520.0021	BRAKE LIGHT SWITCH	469
21 555 013	51.26101.7271	ALTERNATOR	158
21 555 013	51.26101.9271	ALTERNATOR	158
21 555 014	51.26101.7269	ALTERNATOR	158
21 555 014	51.26101.9269	ALTERNATOR	158
21 601 298	81.96601.0298	GASKET	29
21 620 048	81.90620.0048	LOCK RING	37
21 620 085	81.90620.0085	LOCK RING	258
21 655 009	51.26101.7270	ALTERNATOR	159
21 655 009	51.26101.9270	ALTERNATOR	159
21 655 011	51.26101.7268	ALTERNATOR	159
21 689 541	81.26101.6084	ALTERNATOR	159
21 710 001	81.35710.6016	TRUST RING REPAIR KIT	81
21 710 002	81.35710.6008	TRUST RING REPAIR KIT	81
21 710 057	81.90710.0057	WASHER	87
21 710 163	81.91710.0163	SPACER	60
21 722 048	81.43722.0048	STABILIZER MOUNTING	69
21 825 071	90.81690.1173	DRIVE BEARING, STARTER	162
21 825 218	81.26215.6014	DRIVE BEARING, STARTER	162
21 830 013	81.61910.0013	FLUID RESERVOIR	392
21 830 023	81.61910.6023	FLUID RESERVOIR	392
21 830 023	81.61910.6045	FLUID RESERVOIR	392
21 880 166	81.26207.0021	COMMUTATOR END SHIELD	161
21 904 195	51.05904.0195	GASKET	402
21 904 212	51.05904.0212	OIL PAN GASKET	420
21 970 205	81.97440.0205	HOSE CLAMP	407
21 981 001	06.32489.0041	BALL BEARING	4
21 981 004	51.93410.0119	BALL BEARING	4
21 990 501	81.90001.0174	CARDAN BOLT	18
21 994 109	81.90801.0225	LOCK PLATE	37
21 997 065	51.98701.0065	INJECTOR WASHER	411
21 997 090	51.98701.0090	SEAL RING	441
21 997 091	51.98701.0091	INJECTOR WASHER	412
21 997 093	51.98701.0093	SEAL RING	441
21 997 348	51.96501.0337	SEAL RING, SEPERATOR	442
21 997 448	51.96501.0348	DOUBLE SEAL RING	356
21 999 002	51.06599.6033	WATER PUMP KIT	467
21 999 003	51.06599.6052	WATER PUMP KIT	467
22 000 031	81.97610.0317	BRAKE SHOE SPRING	123
22 000 032	81.97610.0208	BRAKE SHOE SPRING	123
22 001 002	81.50212.0036	BRAKE SHOE PIN	122
22 001 003	81.50212.0036S	BRAKE SHOE PIN REPAIR KIT	123
22 010 001	81.51901.6005	BRAKE CAMSHAFT REPAIR KIT	120
22 010 004	81.50301.0223	BRAKE CAMSHAFT	118
22 010 005	81.50301.0224	BRAKE CAMSHAFT	119
22 010 006	81.50301.0113	BRAKE CAMSHAFT	119
22 010 007	81.50301.0112	BRAKE CAMSHAFT	119
22 010 008	81.50301.0225	BRAKE CAMSHAFT	119
22 010 009	81.50301.0226	BRAKE CAMSHAFT	120
22 015 004	81.52101.6153	PRESSURE LIMITER VALVE	132
22 036 000	81.52185.6023	3/2 DIRECTIONAL CONTROL VALVE	201
22 116 075	81.52116.6075	RELAY VALVE	133
22 120 149	81.27120.6149	ABS SENSOR	92

Umschlüsselung / Cross Referenz

AL-HU TECH	MAN	Description	Page
22 120 151	81.27120.6151	ABS SENSOR	92
22 120 156	81.27120.6156	ABS SENSOR	92
22 160 087	81.52160.6087	SOLENOID VALVE	139
22 240 388	81.96210.0388	RUBBER MOUNTING	194
22 260 001	81.97010.6010	SHIFT KNOB	195
22 260 002	81.97010.6012	SHIFT KNOB	195
22 260 003	81.32620.0049	SHIFT KNOB	195
22 260 004	81.32620.0043	SHIFT KNOB	195
22 260 005	81.32620.0044	SHIFT KNOB	196
22 260 006	81.32620.0046	SHIFT KNOB	196
22 260 007	81.32616.0007	INSULATING ELEMENT	190
22 260 008	81.32616.0013	INSULATING ELEMENT	190
22 260 010	81.97010.0210	COVER, GEARSHIFT	186
22 260 011	81.97010.6011	SHIFT KNOB	196
22 260 012	81.97010.6007	SHIFT KNOB	196
22 260 013	81.97010.6013	SHIFT KNOB	197
22 260 014	81.32620.0050	SHIFT KNOB	197
22 260 017	81.52131.6017	CUT-OFF VALVE	187
22 260 021	81.97010.6021	SHIFT KNOB	197
22 260 045	81.32620.0045	SHIFT KNOB	197
22 260 059	81.52170.6127	SHIFTING VALVE	199
22 260 121	81.96420.0142	BELLOW	175
22 260 157	85.32734.6001	MULTIWAY VALVE	191
22 260 163	51.03203.0163	VALVE SEAT RING	454
22 260 168	51.03203.0168	VALVE SEAT RING	454
22 260 171	51.03203.0171	VALVE SEAT RING	454
22 260 184	51.03203.0184	VALVE SEAT RING	455
22 260 242	51.03203.0242	VALVE SEAT RING	455
22 260 267	81.96210.0267	RUBBER MOUNTING	194
22 260 293	51.03203.0293	VALVE SEAT RING	455
22 260 324	81.96420.0324	GEAR LEVER BOOT	188
22 260 357	81.32550.0003	SHIFTING VALVE	199
22 260 457	81.32734.6001	MULTIWAY VALVE	192
22 260 757	81.52170.6128	SPLITTER VALVE	200
22 260 857	81.32734.6027	SHIFTING VALVE	200
22 268 089	81.96210.0089	GEARBOX MOUNTING	188
22 268 189	81.95301.6171	BALL JOINT	174
22 268 289	81.95301.6170	BALL JOINT	174
22 268 589	81.95301.6169	BALL JOINT	175
22 400 006	N1.01106.6148	4-CIRCUIT PROTECTION VALVE	143
22 420 001	06.36064.0164	YOKE	143
22 420 004	81.50822.0006	PISTON RETAINING PLATE	131
22 420 005	81.50802.6025	CALIPER BOLT REPAIR KIT	126
22 420 006	81.50802.6024	TAPPET HEAD REPAIR KIT	142
22 420 007	81.50802.6009	CALIPER BOLT REPAIR KIT	126
22 420 008	81.50802.6007	CALIPER COVER SET	126
22 420 102	81.50802.6021	REPAIR KIT, BRONZE BUSHING	136
22 420 210	81.50610.6210	SLACK ADJUSTER	137
22 420 211	81.50610.6211	SLACK ADJUSTER	137
22 420 944	81.50822.6032	REPAIR KIT, BRAKE CALIPER	135
22 422 010	81.32735.6040	SHIFTING CYLINDER	199
22 422 012	81.32735.6041	SHIFTING CYLINDER	199
22 550 012	81.32550.0012	MAGNETIC VALVE	191
22 610 265	81.97610.0265	SPRING	140

Umschlüsselung / Cross Referenz

AL-HU TECH	MAN	Description	Page
22 655 182	81.32655.6115	SHIFT CYLINDER	194
22 655 182	81.32655.6182	SHIFT CYLINDER	194
22 713 014	81.90713.0014	DAMPING WASHER	187
22 713 015	81.90713.0015	DAMPING WASHER	187
22 722 004	81.52315.6106	HAND BRAKE VALVE REPAIR KIT	130
22 902 175	81.25902.6175	ECAS VALVE REPAIR KIT	128
22 937 015	81.25937.0015	ECAS HEIGHT SENSOR	127
22 937 016	81.25937.0016	ECAS HEIGHT SENSOR	127
23 000 001	81.90001.0414	FITTED BOLT	146
23 000 002	06.02202.1013	HEX COLLAR BOLT	147
23 000 003	06.01494.4734	HEX SHOULDER SCREW	148
23 000 004	06.01493.4719	HEX SHOULDER STUD	150
23 000 005	06.01494.6724	HEX SHOULDER SCREW	148
23 000 006	06.01493.4730	HEX SHOULDER SCREW	148
23 000 007	06.02191.2923	CYLINDER SCREW	145
23 000 008	06.01499.0173	HEX SHOULDER SCREW	149
23 000 009	06.01494.4718	HEX SHOULDER SCREW	149
23 000 010	06.01493.4740	HEX SHOULDER SCREW	149
23 000 011	06.01493.4733	HEX SHOULDER STUD	150
23 000 012	06.01493.4725	HEX SHOULDER STUD	151
23 000 013	06.01493.4925	HEX SHOULDER SCREW	149
23 000 014	06.01733.4921	HEX BOLT	147
23 000 015	81.90030.0146	CYLINDER LOCK SCREW	144
23 303 022	81.44303.0022	WASHER	87
23 303 034	81.44303.0034	WASHER	87
23 320 002	81.41352.0002	CAP	18
23 320 241	81.41301.0241	BRACKET	15
23 321 186	81.96020.0186	RUBBER MOUNTING	45
23 321 230	81.96020.0230	SPRING BUFFER	62
23 322 110	81.41301.6114	SPRING BRACKET	61
23 322 111	81.41301.6115	SPRING BRACKET	62
23 323 009	81.41352.0009	CAP	18
23 323 010	81.41715.6010	LOCATING ARM	36
23 323 021	81.44204.0021	STABILIZER MOUNTING	69
23 323 029	81.43704.0029	STABILIZER MOUNTING	69
23 323 047	81.43722.0047	STABILIZER MOUNTING	69
23 323 057	81.43704.0057	STABILIZER MOUNTING	70
23 323 059	81.35401.0059	TRUNNION	80
23 323 074	81.43704.0074	STABILIZER MOUNTING	70
23 323 077	81.43704.0077	STABILIZER MOUNTING	70
23 323 078	81.43704.0078	STABILIZER MOUNTING	70
23 323 081	81.43271.0081	STABILIZER MOUNTING	71
23 323 089	81.35401.0089	TRUNNION	81
23 323 150	81.96210.0150	STABILIZER MOUNTING	71
23 323 159	81.43722.0059	STABILIZER MOUNTING	71
23 323 344	81.41701.5344	CAB SUPPORT	17
23 323 345	81.41701.5345	CAB SUPPORT	17
23 324 004	81.41405.0004	GLIDER PLATE	30
23 324 006	81.96020.6006	SPRING BUFFER	62
23 324 012	81.41405.0012	GLIDER PLATE	30
23 324 040	81.41304.0040	SPRING BUSHING	63
23 324 061	81.43722.0061	SPRING BUSHING	63
23 324 062	81.43722.0062	SPRING BUSHING	64
23 324 070	81.43722.0070	SPRING BUSHING	64

Umschlüsselung / Cross Referenz

AL-HU TECH	MAN	Description	Page
23 324 079	81.41303.0079	SPRING SHACKLE	68
23 324 086	81.43722.0085	STABILIZER MOUNTING	71
23 324 253	81.41301.0253	SPRING BRACKET	62
23 324 739	81.96101.0739	SPRING BUFFER	63
23 325 001	81.41350.0009	SPRING HANGER	66
23 325 018	81.41350.0018	SPRING HANGER	67
23 325 022	81.96210.5022	SPRING CUSHION	65
23 325 025	81.96210.5025	SPRING CUSHION	65
23 325 065	81.41320.0065	SPRING SADDLE	68
23 325 074	81.43271.0074	STABILIZER MOUNTING	72
23 325 106	81.41301.5106	BRACKET	15
23 325 193	81.43705.0193	BRACKET	16
23 325 550	81.96210.0550	SPRING CUSHION	66
23 325 554	81.96210.0554	SPRING CUSHION	66
23 325 555	81.96210.0555	SPRING CUSHION	66
23 326 017	81.41350.0017	SPRING HANGER	67
23 326 025	81.43316.0021	STABILIZER MOUNTING	72
23 326 030	81.41302.0030	WASHER	88
23 326 032	81.43704.0032	STABILIZER MOUNTING	72
23 326 040	81.43722.0040	STABILIZER MOUNTING	72
23 326 052	81.43722.0052	STABILIZER MOUNTING	73
23 326 053	81.43722.0053	STABILIZER MOUNTING	73
23 326 060	81.43704.0060	STABILIZER MOUNTING	73
23 326 061	81.43704.0061	STABILIZER MOUNTING	73
23 326 062	81.43722.0051	STABILIZER MOUNTING	74
23 326 062	81.43722.0060	STABILIZER MOUNTING	74
23 326 063	81.43722.0063	STABILIZER MOUNTING	74
23 326 068	81.43722.0068	STABILIZER MOUNTING	74
23 326 072	81.43722.0072	STABILIZER MOUNTING	74
23 326 078	81.43271.0078	STABILIZER MOUNTING	75
23 326 080	81.43271.0080	STABILIZER MOUNTING	75
23 326 082	81.43271.0082	STABILIZER MOUNTING	75
23 326 083	81.43271.0083	STABILIZER MOUNTING	75
23 326 431	81.96210.0431	SPRING BUFFER	63
23 326 450	81.96210.0450	STABILIZER MOUNTING	76
23 326 511	81.96210.0452	STABILIZER MOUNTING	76
23 326 511	81.96210.0511	STABILIZER MOUNTING	76
23 326 511	81.99164.8844	STABILIZER MOUNTING	76
23 327 083	81.43722.0083	STABILIZER MOUNTING	76
23 330 009	81.44205.6009	KING PIN SET	34
23 330 010	81.44205.6010	KING PIN SET	34
23 330 013	81.44205.6013	KING PIN SET	34
23 330 016	81.44205.6016	KING PIN SET	34
23 330 018	81.44205.6018	KING PIN SET	35
23 330 023	81.44205.6023	KING PIN SET	35
23 330 024	81.44205.6024	KING PIN SET	35
23 330 025	81.44205.6025	KING PIN SET	35
23 330 027	81.44205.6027	KING PIN SET	36
23 330 030	81.44205.6030	KING PIN SET	36
23 330 030	81.44205.6037	KING PIN SET	36
23 330 031	81.44205.6031	KING PIN SET	36
23 330 031	81.44205.6038	KING PIN SET	36
23 330 035	81.95301.6239	TIE ROD END	332
23 330 035	81.95301.6272	TIE ROD END	332

Umschlüsselung / Cross Referenz

AL-HU TECH	MAN	Description	Page
23 330 133	81.95301.6133	BALL JOINT REPAIR KIT	5
23 330 706	81.95301.6132	BALL JOINT REPAIR KIT	5
23 331 009	81.43315.0009	BALL JOINT REPAIR KIT	6
23 332 011	81.50308.0011	SEAL HOLDER	53
23 332 141	81.50101.5141	DUST COVER	26
23 350 001	81.43220.6285	BALL JOINT REPAIR KIT	6
23 350 002	85.43220.6002	BALL JOINT REPAIR KIT	6
23 350 003	81.43270.6100	BALL JOINT REPAIR KIT	6
23 350 004	81.43270.6072	BALL JOINT REPAIR KIT	7
23 350 009	81.43250.6009	BALL JOINT REPAIR KIT	7
23 350 010	81.43270.6080	BALL JOINT REPAIR KIT	7
23 350 011	81.43270.6133	BALL JOINT REPAIR KIT	7
23 350 012	81.95302.0077	BALL JOINT REPAIR KIT	8
23 350 013	81.96401.0152	BALL JOINT REPAIR KIT	8
23 350 015	81.43220.6203	BALL JOINT REPAIR KIT	8
23 350 016	81.43220.6190	CONTROL ARM	19
23 350 017	81.43220.6189	CONTROL ARM	19
23 350 018	81.43220.6185	CONTROL ARM	19
23 350 043	81.43230.6043	BALL JOINT REPAIR KIT	8
23 350 051	81.43230.6051	BALL JOINT REPAIR KIT	9
23 350 058	81.43230.6058	CONTROL ARM	19
23 350 065	81.43270.6065	BALL JOINT REPAIR KIT	9
23 350 076	81.43270.6076	CONTROL ARM	20
23 350 079	81.43270.6079	BALL JOINT REPAIR KIT	9
23 350 087	81.43270.6087	CONTROL ARM	20
23 350 092	81.43220.6092	CONTROL ARM	20
23 350 096	81.43270.6096	CONTROL ARM	20
23 350 097	81.43220.6097	CONTROL ARM	21
23 350 097	81.43220.6129	CONTROL ARM	21
23 350 106	81.43270.6105	BALL JOINT REPAIR KIT	9
23 350 107	81.43220.6107	BALL JOINT REPAIR KIT	10
23 350 107	81.95302.0059	BALL JOINT REPAIR KIT	10
23 350 108	81.43220.6108	BALL JOINT REPAIR KIT	10
23 350 109	81.43220.6073	BALL JOINT REPAIR KIT	10
23 350 111	81.43220.6183	CONTROL ARM	21
23 350 112	81.43220.6112	CONTROL ARM	21
23 350 113	81.43220.6202	BALL JOINT REPAIR KIT	10
23 350 114	81.43220.6244	BALL JOINT REPAIR KIT	11
23 350 115	81.43220.6275	CONTROL ARM	320
23 350 116	81.43230.6061	BALL JOINT REPAIR KIT	11
23 350 117	81.43270.6040	BALL JOINT REPAIR KIT	11
23 350 118	81.43270.6077	CONTROL ARM	21
23 350 121	81.43230.6037	CONTROL ARM	22
23 350 125	81.43220.6093	CONTROL ARM	22
23 350 126	81.43270.6137	CONTROL ARM	22
23 350 128	81.43270.6117	CONTROL ARM	22
23 350 137	81.43220.6135	CONTROL ARM	23
23 350 137	81.43220.6137	CONTROL ARM	23
23 350 196	81.43220.6196	CONTROL ARM	23
23 350 204	81.43220.6204	BALL JOINT REPAIR KIT	11
23 350 220	81.43220.6220	CONTROL ARM	23
23 350 229	81.43220.6229	CONTROL ARM	23
23 350 229	81.43220.6268	CONTROL ARM	23
23 350 236	81.43220.6236	CONTROL ARM	24

Umschlüsselung / Cross Referenz

AL-HU TECH	MAN	Description	Page
23 350 236	81.43220.9236	CONTROL ARM	24
23 350 250	81.43220.6250	BALL JOINT REPAIR KIT	12
23 350 447	81.96210.0447	AXLE ROD MOUNTING	3
23 350 448	81.96210.0448	AXLE ROD MOUNTING	4
23 350 905	81.43270.6110	BALL JOINT REPAIR KIT	12
23 351 006	81.41351.0006	OIL SEAL	192
23 352 505	81.43220.6322	BALL JOINT REPAIR KIT	12
23 356 001	81.41353.0001	PROTECTIVE RING	43
23 356 002	81.41355.0001	LOCK RING	37
23 356 141	81.35701.0141	WHEEL HUB	91
23 356 215	81.35710.0045	PRESSURE RING	40
23 356 415	81.35710.0044	PRESSURE RING	40
23 410 118	81.50410.6118	SPRING BRAKE CYLINDER	141
23 460 202	81.95301.6202	TIE ROD END	332
23 460 204	81.95301.6204	BALL JOINT	318
23 460 248	81.95301.6234	TIE ROD END	333
23 460 248	81.95301.6274	TIE ROD END	333
23 460 248	81.95301.6308	TIE ROD END	333
23 460 248	81.95301.6350	TIE ROD END	333
23 460 319	81.93001.0319	CONTROL ARM BUSHING	24
23 460 448	81.95301.6309	TIE ROD END	333
23 460 448	81.95301.6351	TIE ROD END	333
23 500 003	81.43610.6129	AIR SPRING VALVE	116
23 500 008	84.43610.6006	AIR SPRING VALVE	116
23 500 094	81.43610.6054	AIR SPRING VALVE	116
23 500 095	81.43610.6061	AIR SPRING VALVE	117
23 705 241	81.43705.0241	BRACKET	16
23 705 242	81.43705.0242	BRACKET	16
23 718 043	81.43718.0043	BEARING CAP	14
23 718 044	81.43718.0044	BEARING CAP	15
24 000 002	81.52452.6014	ABS SOLENOID VALVE	98
24 000 002	81.52452.6015	ABS SOLENOID VALVE	98
24 000 003	81.43618.6008	LOAD SENSING VALVE	131
24 000 004	81.52130.6149	FOOT BRAKE VALVE	128
24 000 004	81.52130.6222	FOOT BRAKE VALVE	128
24 000 005	81.52130.6192	FOOT BRAKE VALVE	129
24 000 005	81.52130.6218	FOOT BRAKE VALVE	129
24 000 006	81.52130.6148	FOOT BRAKE VALVE	129
24 000 006	81.52130.6150	FOOT BRAKE VALVE	129
24 000 006	81.52130.6219	FOOT BRAKE VALVE	129
24 000 007	81.52101.6269	PRESSURE LIMITER VALVE	132
24 000 008	81.52101.6270	PRESSURE LIMITER VALVE	132
24 000 009	81.52102.6098	AIR DRYER	114
24 000 009	81.52102.6100	AIR DRYER	114
24 000 010	81.52102.6101	AIR DRYER	114
24 001 100	81.43609.6008	RELAY VALVE	134
24 001 200	81.52116.6022	RELAY VALVE	134
24 001 221	81.52150.6011	RELAY VALVE	134
24 002 107	81.51230.6009	SHUT-OFF VALVE	136
24 002 210	81.52301.6165	TRAILER CONTROL VALVE	142
24 013 116	81.52185.6018	ENGINE STOP VALVE	128
24 051 111	81.30725.6026	CLUTCH BOOSTER	176
24 051 157	81.30725.6053	CLUTCH BOOSTER	176
24 051 176	N1.01101.0080	CLUTCH BOOSTER	177

Umschlüsselung / Cross Referenz

AL-HU TECH	MAN	Description	Page
24 051 307	81.30725.6065	CLUTCH BOOSTER	177
24 051 406	81.30725.6069	CLUTCH BOOSTER	177
24 051 412	81.30725.6084	CLUTCH BOOSTER	177
24 051 441	81.30725.6104	CLUTCH BOOSTER	178
24 051 905	81.30725.6040	CLUTCH BOOSTER KIT	178
24 106 027	81.51101.6455	BRAKE CHAMBER	120
24 106 028	81.51101.6481	BRAKE CHAMBER	121
24 130 010	51.54112.6008	AIR COMPRESSOR HOUSING	110
24 130 916	51.54106.6021	AIR COMPRESSOR CONROD	102
24 170 156	81.52170.6156	3/2 WAY VALVE	143
24 300 000	81.52101.6118	REPAIR KIT, UNLOADER VALVE	136
24 303 473	81.52101.6076	PRESSURE REGULATOR	133
24 303 474	84.52101.6017	PRESSURE REGULATOR	133
24 407 060	81.52101.6274	SILENCER	136
24 407 070	81.52101.6275	SILENCER	137
24 407 071	81.52101.6264	SILENCER	137
24 410 010	81.52102.6072	AIR DRYER	115
24 410 017	81.39410.6017	PROPELLER SHAFT BEARING	41
24 410 017	81.39410.6019	PROPELLER SHAFT BEARING	41
24 410 018	81.39410.6018	PROPELLER SHAFT BEARING	41
24 410 021	81.39410.6021	PROPELLER SHAFT BEARING	42
24 410 023	81.39410.6023	PROPELLER SHAFT BEARING	42
24 410 023	81.39410.6031	PROPELLER SHAFT BEARING	42
24 410 023	81.39410.6034	PROPELLER SHAFT BEARING	42
24 420 006	81.51901.6006	BRAKE CAMSHAFT REPAIR KIT	120
24 420 014	06.36959.0014	BEARING BUSH	14
24 420 019	81.50201.6190	BRAKE SHOE	121
24 420 022	81.50802.6022	REPAIR KIT RUBBER BUSH	135
24 420 092	81.50610.6132	SLACK ADJUSTER KIT	139
24 420 184	81.50201.6184	BRAKE SHOE	122
24 420 188	81.50201.6188	BRAKE SHOE	122
24 420 243	81.90713.0243	SPACER	60
24 420 519	81.50201.6218	BRAKE SHOE	122
24 430 118	81.52315.6156	HAND BRAKE VALVE	130
24 460 009	81.46433.6009	STEERING LOCK	328
24 460 013	81.46433.6013	STEERING LOCK	328
24 460 069	81.46430.0069	STEERING WHEEL	330
24 460 133	81.46611.6197	DRAG LINK	321
24 460 648	81.46610.6648	DRAG LINK	322
24 460 652	81.46611.6067	DRAG LINK	322
24 460 653	81.46611.6061	DRAG LINK	321
24 460 654	81.46711.6778	DRAG LINK	322
24 460 722	81.46610.6722	DRAG LINK	322
24 460 725	81.46711.6725	TIE ROD	330
24 460 725	81.46711.6820	TIE ROD	330
24 460 779	81.46610.6779	DRAG LINK	323
24 461 112	81.46122.6112	STEERING SHAFT	329
24 500 020	81.51270.6026	LINE FILTER, COMPRESSOR SYSTEM	131
24 997 005	06.67049.0005	EXHAUST CLAMP	364
24 997 017	81.97420.2017	EXHAUST CLAMP	364
24 997 023	81.97420.0023	EXHAUST CLAMP	364
24 997 026	81.97420.0026	EXHAUST CLAMP	365
24 997 073	81.97420.0073	EXHAUST CLAMP	365
24 997 085	81.97420.0085	EXHAUST CLAMP	365

Umschlüsselung / Cross Referenz

AL-HU TECH	MAN	Description	Page
24 997 085	81.97420.0139	EXHAUST CLAMP	365
24 997 099	06.67042.0116	EXHAUST CLAMP	365
24 997 099	06.67049.0099	EXHAUST CLAMP	365
24 997 113	06.67042.0113	EXHAUST CLAMP	366
24 997 152	81.97420.0152	EXHAUST CLAMP	366
24 997 157	81.97420.0157	EXHAUST CLAMP	366
25 131 015	81.52131.6015	5/2 WAY VALVE	201
25 215 002	88.25310.6002	INDICATOR RELAY	164
25 215 006	81.25311.0006	INDICATOR RELAY	164
25 215 350	81.25311.0005	INDICATOR RELAY	164
25 215 450	81.25311.0023	INDICATOR RELAY	164
25 215 550	81.25310.0034	INDICATOR RELAY	165
25 226 013	81.25509.0013	STEERING COLUMN SWITCH	493
25 226 024	81.25509.0020	STEERING COLUMN SWITCH	493
25 226 056	81.25509.6056	STEERING COLUMN SWITCH	493
25 226 117	81.25509.0124	STEERING COLUMN SWITCH	494
25 226 118	81.25509.0123	STEERING COLUMN SWITCH	494
25 226 118	81.25509.0144	STEERING COLUMN SWITCH	494
25 226 259	85.20001.2158	STEERING COLUMN SWITCH	494
25 226 468	81.25505.0468	STEERING COLUMN SWITCH	495
25 226 909	81.25509.0018	STEERING COLUMN SWITCH	495
25 226 921	81.25509.0116	STEERING COLUMN SWITCH	495
25 229 889	81.25229.0889	LENS	257
25 250 001	81.30560.0061	CLUTCH RELEASE LEVER	185
25 250 010	81.30300.6004	CLUTCH REPAIR KIT	185
25 260 003	81.32734.6015	SHIFTING VALVE	200
25 260 004	81.25260.6105	SIDE MARKER LIGHT	287
25 260 005	81.25320.6078	FLASHER LAMP	241
25 260 006	81.25320.6084	INDICATOR LAMP	255
25 260 007	81.25320.6087	INDICATOR LAMP	256
25 542 097	81.27421.0097	OIL PRESSURE SWITCH	478
25 542 109	81.27421.0109	OIL PRESSURE SENDER	478
25 542 120	81.25301.6066	HORN 24V, 335 HZ	163
25 545 000	81.25506.7000	MAIN BATTERY SWITCH	477
25 545 006	81.25501.6012	STARTER SWITCH	493
25 545 013	81.25501.6005	IGNITION SWITCH	476
25 545 037	81.25506.6033	MAIN BATTERY SWITCH	477
25 545 037	81.25506.6037	MAIN BATTERY SWITCH	477
25 545 037	81.25506.6120	MAIN BATTERY SWITCH	477
25 545 038	81.25502.0018	MAIN BATTERY SWITCH KEY	478
25 545 060	81.25444.6060	CENTRAL ELECTRIC	161
25 545 074	81.25444.6074	CENTRAL ELECTRIC	161
25 545 107	81.25927.0107	RELAIS	166
25 545 128	81.25503.6128	POWER CONTROL SWITCH	480
25 545 131	81.25503.6131	TOGGLE SWITCH	501
25 545 152	81.25520.0152	BRAKE SWITCH	469
25 545 209	81.25503.6209	TOGGLE SWITCH	501
25 545 223	81.25503.0223	TOGGLE SWITCH	501
25 545 225	81.25907.0225	POTENTIOMETER SWITCH	479
25 545 255	81.25505.6255	TOGGLE SWITCH	501
25 545 259	81.25505.6259	TOGGLE SWITCH	502
25 545 260	81.25505.6260	TOGGLE SWITCH	502
25 545 262	81.25505.6262	TOGGLE SWITCH	502
25 545 265	81.25505.6265	TOGGLE SWITCH	502

Umschlüsselung / Cross Referenz

AL-HU TECH	MAN	Description	Page
25 545 267	81.25503.6267	TOGGLE SWITCH	503
25 545 268	81.25505.6267	TOGGLE SWITCH	503
25 545 270	81.25505.6270	TOGGLE SWITCH	503
25 545 271	81.25505.6271	TOGGLE SWITCH	503
25 545 274	81.25505.6274	TOGGLE SWITCH	504
25 545 280	81.25505.6280	TOGGLE SWITCH	504
25 545 282	81.25505.6282	TOGGLE SWITCH	504
25 545 288	81.25505.6288	TOGGLE SWITCH	504
25 545 291	81.25505.6291	TOGGLE SWITCH	505
25 545 292	81.25505.6292	TOGGLE SWITCH	505
25 545 302	81.25503.6302	TOGGLE SWITCH	505
25 545 327	81.25505.6327	TOGGLE SWITCH	505
25 545 376	81.25902.0376	RELAIS	166
25 545 378	81.25505.6378	TOGGLE SWITCH	506
25 545 410	81.25902.0410	RELAIS	166
25 545 469	81.25902.0469	RELAIS	167
25 545 473	81.25902.0473	RELAIS	167
25 545 474	81.25902.0474	RELAY, 2-WAY CONTACT	167
25 545 478	81.25902.0378	SPEED SENSOR	168
25 545 497	81.25902.0441	CONTROL UNIT, GLOW PLUG SYSTEM	162
25 545 497	81.25902.0497	CONTROL UNIT, GLOW PLUG SYSTEM	162
25 545 513	81.25501.6033	IGNITION SWITCH	476
25 545 519	81.25902.0519	LOAD RELAY	165
25 545 524	81.25902.0524	RELAIS	438
25 545 607	81.25505.6607	TOGGLE SWITCH	506
25 545 613	81.25501.6025	IGNITION SWITCH	476
25 545 713	81.25501.6020	IGNITION SWITCH	477
25 545 714	81.27421.0056	REVERSE LIGHT SWITCH	488
25 545 814	81.25505.0636	REVERSE LIGHT SWITCH	488
25 545 909	81.25503.6300	TOGGLE SWITCH	506
25 580 007	81.32580.0007	BLEEDER VALVE	175
25 605 111	81.32605.6111	SHIFT MECHANISM	198
25 655 157	81.32655.6157	REPAIR KIT, SHIFT MECHANISM	194
25 670 199	81.32670.6199	GEARSHIFT LEVER REPAIR KIT	189
25 810 049	81.63733.6049	MIRROR GLASS	268
25 810 057	81.63733.6057	MIRROR GLASS	268
25 810 430	81.63730.6430	MIRROR	260
25 810 432	81.63730.6432	MIRROR	260
25 810 512	81.63730.6512	MIRROR	260
25 810 513	81.63730.6513	MIRROR	260
25 810 557	81.63731.6557	MIRROR ARM	263
25 810 560	81.63731.6560	MIRROR ARM	263
25 820 520	81.90820.0520	WIRE RING	201
25 927 099	81.25927.0099	DIODE RELAY	473
26 000 001	81.48227.0006	PEDAL PAD	275
26 210 021	85.61210.0021	STEP HOUSING	290
26 210 022	85.61210.0022	STEP HOUSING	290
26 240 001	81.96210.0430	RUBBER BUFFER	282
26 340 063	81.62340.6063	SEAT REPAIR KIT	284
26 340 064	81.62340.6064	SEAT REPAIR KIT	284
26 383 055	81.62383.6055	SEAT REPAIR KIT	285
26 383 057	81.62383.6057	SEAT REPAIR KIT	285
26 384 008	81.62384.6008	SEAT REPAIR KIT	285
26 385 025	81.62385.6025	SHOCK ABSORBER KIT	286

Umschlüsselung / Cross Referenz

AL-HU TECH	MAN	Description	Page
26 385 033	81.62385.6033	SEAT REPAIR KIT	285
26 392 003	81.62392.6003	SEAT REPAIR KIT	286
26 398 004	81.62398.6004	SEAT LEVELLING VALVE KIT	284
26 398 018	81.62398.6018	SEAT REPAIR KIT	286
26 398 019	81.62398.6019	SEAT REPAIR KIT	286
26 416 229	81.41610.0229	BUMPER PANEL	217
26 416 230	81.41610.0230	BUMPER PANEL	218
26 420 125	81.66420.0125	BRACKET	212
26 421 066	81.26421.0066	WIPER PIVOT-SHAFT	317
26 421 067	81.26421.0067	WIPER PIVOT-SHAFT	317
26 421 068	81.26421.0068	LEVER, WINDSCREEN WIPER	257
26 430 080	81.26430.0080	WIPER ARM	312
26 444 013	81.61444.0013	TURN LOCK	303
26 481 026	81.26481.0026	LOCK, WATER CONTAINER	259
26 503 129	81.96503.0129	SEAL RING	283
26 503 443	81.96503.0443	OIL SEAL	275
26 608 030	51.06608.0030	FAN SHROUD	240
26 610 226	81.41610.0226	CORNER COVER, RIGHT	230
26 610 231	81.41610.0231	BUMPER END PANEL	216
26 610 232	81.41610.0232	BUMPER END PANEL	216
26 610 307	81.41610.0307	BUMPER	213
26 610 308	81.41610.0308	BUMPER	213
26 611 063	81.61110.0063	PANEL	275
26 624 046	81.62410.0046	CORNER COVER	229
26 624 047	81.62410.0047	CORNER COVER	229
26 624 089	81.62410.0089	WIND DEFLECTOR	305
26 624 090	81.62410.0090	WIND DEFLECTOR	305
26 624 091	81.62410.0091	CORNER COVER	230
26 624 092	81.62410.0092	CORNER COVER	230
26 640 011	85.62640.6011	WINDOW REGULATOR	308
26 640 012	85.62640.6012	WINDOW REGULATOR	309
26 640 114	81.43640.5114	BRACKET	212
26 641 097	81.62641.6097	REPAIR KIT OUTSIDE DOOR HANDLE	280
26 641 293	81.66410.0293	MUDGUARD	269
26 641 294	81.66410.0294	MUDGUARD	269
26 641 306	81.66410.0306	MUDGUARD TRIM PLATE	273
26 641 307	81.66410.0307	MUDGUARD TRIM PLATE	273
26 641 308	81.66410.0308	MUDGUARD TRIM PLATE	273
26 641 309	81.66410.0309	MUDGUARD TRIM PLATE	273
26 660 000	81.41610.0361	BUMPER	213
26 660 001	81.41610.0364	BUMPER	214
26 660 002	81.41610.0369	BUMPER END PANEL	216
26 660 003	81.41610.0370	BUMPER END PANEL	217
26 660 004	81.41614.0023	BUMPER CORNER	215
26 660 005	81.41614.0024	BUMPER CORNER	215
26 660 006	81.61110.6042	FRONT SERVICE DOOR	243
26 660 007	81.61110.6048	WIND DEFLECTOR RIGHT	306
26 660 008	81.61110.6049	WIND DEFLECTOR LEFT	305
26 660 009	81.61510.0410	MUDGUARDS EXTENSION	274
26 660 010	81.61510.0411	MUDGUARDS EXTENSION	274
26 660 011	81.63701.0044	SUN VISOR	296
26 660 012	81.63701.0057	SUN VISOR	296
26 660 013	81.66410.0172	MUDGUARD	270
26 660 014	81.66410.0173	MUDGUARD	270

Umschlüsselung / Cross Referenz

AL-HU TECH	MAN	Description	Page
26 660 015	81.66410.6086	MUDGUARD	270
26 660 016	81.66410.6606	MUDGUARD	270
26 662 158	81.06620.0158	FAN SHROUD	240
26 680 132	81.62680.0132	BOWDEN CABLE	209
26 690 036	81.62690.6036	DOOR HINGE	235
26 690 037	81.62690.6037	DOOR HINGE	236
26 731 180	81.63731.0180	MIRROR COVER	266
26 732 059	81.63732.0059	MIRROR COVER	266
26 745 016	81.63745.0016	TOOL BOX DOOR	300
26 745 017	81.63745.0017	TOOL BOX DOOR	301
26 810 909	51.08101.0909	EXHAUST MANIFOLD	368
26 810 910	51.08101.0910	EXHAUST MANIFOLD	368
26 810 911	51.08101.0911	EXHAUST MANIFOLD	368
26 810 912	51.08101.0912	EXHAUST MANIFOLD	368
26 810 913	51.08101.0913	EXHAUST MANIFOLD	369
26 810 915	51.08101.0914	EXHAUST MANIFOLD	369
26 810 916	51.08102.0024	EXHAUST MANIFOLD	369
26 980 031	81.61980.6031	TEMPERATURE SWITCH	500
27 000 000	81.47301.6048	OIL RESERVOIR	328
27 113 042	81.46113.6042	STEERING SPINDLE	330
27 467 762	81.46711.6762	DRAG LINK	323
28 000 001	51.05503.6096	OIL FILTER HEAD	418
28 000 002	51.05904.0198	OIL PAN GASKET	420
28 000 003	81.08304.0023	FILTER HOUSING	391
28 000 006	51.12101.7047	FUEL PUMP	402
28 000 006	51.12101.7136	FUEL PUMP	402
28 000 007	51.12101.7046	FUEL PUMP	402
28 000 007	51.12101.7137	FUEL PUMP	402
28 000 008	51.01304.6062	TIMING CASE	447
28 000 009	51.01305.5102	TIMING COVER	447
28 000 010	51.01601.5065	OIL SPRAYER NOZZLE	425
28 000 011	51.02201.0099	VIBRATION DAMPER	456
28 000 012	51.05405.7017	OIL PRESSURE VALVE	421
28 000 013	51.05405.7044	OIL PRESSURE VALVE	421
28 000 014	51.05405.0012	OIL PRESSURE VALVE	421
28 000 142	51.11401.0142	MOUNTING FLANGE	413
28 010 022	51.90490.0022	CYLINDER HEAD SCREW	355
28 010 023	51.90490.0023	CYLINDER HEAD SCREW	356
28 010 024	51.90490.0024	CYLINDER HEAD SCREW	356
28 010 242	51.90020.0242	HEX. BOLT	406
28 030 009	51.02301.7440	FLYWHEEL	394
28 030 010	51.02301.7389	FLYWHEEL	395
28 030 011	51.02301.6033	FLYWHEEL	395
28 030 013	51.02301.5109	FLYWHEEL	395
28 030 014	51.02301.6050	FLYWHEEL	395
28 030 015	51.02301.6044	FLYWHEEL	396
28 030 021	51.02301.5167	FLYWHEEL	396
28 030 259	51.02301.5259	FLYWHEEL	396
28 102 077	51.08102.0077	EXHAUST MANIFOLD	369
28 105 075	51.06606.0075	V-BELT PULLEY	459
28 105 185	51.26105.0185	V-BELT PULLEY	459
28 105 248	51.26105.0248	V-BELT PULLEY	459
28 107 064	51.19107.0064	GUIDE PIECE, TENSIONER	403
28 115 076	51.02115.6076	TIMING GEAR	448

Umschlüsselung / Cross Referenz

AL-HU TECH	MAN	Description	Page
28 130 335	51.93020.0335	AIR COMPRESSOR BUSH	101
28 210 034	81.12210.0034	TANK CAP	444
28 210 366	81.96210.0366	ENGINE MOUNTING	362
28 229 603	81.25229.0603	LENS	257
28 240 002	81.41506.0096	ENGINE MOUNTING	362
28 240 003	81.96210.0440	ENGINE MOUNTING	362
28 240 004	81.96210.0571	ENGINE MOUNTING	363
28 240 005	81.96210.0441	ENGINE MOUNTING	363
28 252 033	81.25228.6033	TAIL LAMP	297
28 252 034	81.25228.6034	TAIL LAMP	297
28 252 051	81.25229.6051	TAIL LAMP LENS	300
28 252 523	81.25225.6523	TAIL LAMP	297
28 252 524	81.25225.6524	TAIL LAMP	298
28 252 784	81.25229.0784	REVERSE LIGHT LENS	281
28 264 113	81.26411.6113	WIPER LINKAGE	314
28 310 198	51.90310.0198	DRAIN PLUG	356
28 317 412	81.96210.0437	CABIN MOUNTING	221
28 320 001	81.25229.0832	INDICATOR LAMP	256
28 320 002	81.25320.6082	INDICATOR LAMP	256
28 405 502	04.27405.9502	RADIATOR HOSE	434
28 405 860	04.27405.9860	RADIATOR HOSE	434
28 417 090	81.41720.0090	JOINT BEARING	257
28 417 091	81.41720.0091	BRACKET LEFT	213
28 420 000	81.96420.0118	BELLOW	337
28 421 190	51.27421.0190	TEMPERATURE SENSOR	499
28 471 024	51.47104.0024	DRIVING DOG	358
28 500 012	85.96210.0012	CABIN MOUNTING	221
28 500 019	85.96210.0019	CABIN MOUNTING	221
28 500 021	85.96210.0021	CABIN MOUNTING	221
28 500 210	06.36950.0210	BEARING BUSH	205
28 500 437	81.96210.0437	CABIN MOUNTING KIT	224
28 500 638	81.96101.0638	CAB TILT OUTER WASHER	218
28 500 909	81.90713.0909	CABIN MOUNTING	222
28 503 094	51.05503.6094	OIL FILTER HEAD	418
28 505 011	51.05505.0011	COVER, OIL FILTER	352
28 520 192	81.66440.0192	RUBBER FOR FENDER	283
28 522 067	81.66410.0226	RUBBER FOR FENDER	283
28 522 517	81.96001.0517	GUIDE RING, BUMPER	249
28 540 001	81.25225.6547	TAIL LAMP	298
28 540 002	81.25225.6544	TAIL LAMP	298
28 540 005	81.25229.6059	TAIL LAMP LENS	300
28 540 006	81.25229.6060	TAIL LAMP LENS	300
28 540 022	81.25225.6545	TAIL LAMP	298
28 553 005	81.41723.6099	CABIN CYLINDER	219
28 553 101	81.41723.6114	CABIN PUMP	224
28 553 105	81.41723.6123	CABIN CYLINDER	219
28 553 201	85.41723.6011	CABIN PUMP	225
28 553 201	85.41723.6020	CABIN PUMP	225
28 553 201	85.41723.6044	CABIN PUMP	225
28 553 205	81.41723.6124	CABIN CYLINDER	219
28 553 305	81.41723.6076	CABIN CYLINDER	219
28 560 017	81.05601.0017	OIL COOLER	415
28 600 024	04.27405.9160	RADIATOR HOSE	434
28 600 093	51.06600.6093	FAN BEARING	379

Umschlüsselung / Cross Referenz

AL-HU TECH	MAN	Description	Page
28 601 473	51.02601.0473	V-BELT PULLEY	457
28 601 506	51.02601.0506	V-BELT PULLEY	457
28 610 044	51.97610.0044	SPRING, BELT TIGHTENER	442
28 613 141	81.06130.0141	INTERCOOLER	412
28 618 003	85.61851.6003	CABIN LOCK	220
28 618 023	81.61851.6023	CABIN LOCK	220
28 618 023B	81.61851.6023	CABIN LOCK	220
28 618 510	06.36950.0510	JOINT BEARING	327
28 619 001	81.61910.0019	POLLEN FILTER	276
28 619 002	85.61950.0025	POLLEN FILTER	276
28 619 003	81.61910.0011	POLLEN FILTER	276
28 619 004	81.61910.0018	POLLEN FILTER	276
28 620 224	81.62410.2224	SIDE TRIM	287
28 620 225	81.62410.2225	SIDE TRIM	288
28 626 095	81.62680.6095	DOOR LOCK	236
28 626 096	81.62680.6096	DOOR LOCK	237
28 637 007	81.63733.6007	MIRROR GLASS	268
28 637 027	81.63733.0027	MIRROR GLASS	268
28 637 030	81.63733.0030	MIRROR GLASS	269
28 637 061	81.63733.0061	MIRROR GLASS	269
28 637 148	81.63730.6148	MIRROR	261
28 637 151	81.63730.6151	MIRROR	261
28 637 224	81.63730.6224	MIRROR GLASS	262
28 637 233	81.63730.6233	MIRROR	261
28 637 235	81.63730.6235	MIRROR	261
28 637 236	81.63730.6236	MIRROR	262
28 638 061	81.63732.0061	MIRROR COVER	266
28 638 062	81.63732.0062	MIRROR COVER	266
28 640 055	81.62640.6055	WINDOW REGULATOR	309
28 640 056	81.62640.6056	WINDOW REGULATOR	309
28 640 067	81.62641.6067	DOOR HANDLE	233
28 640 068	81.62641.6068	DOOR HANDLE	233
28 641 085	81.62641.6081	DOOR HANDLE	233
28 641 085	81.62641.6085	DOOR HANDLE	233
28 641 086	81.62641.6080	DOOR HANDLE	234
28 641 086	81.62641.6086	DOOR HANDLE	234
28 660 027	85.61510.5027	STEPWELL	291
28 660 028	85.61510.5028	STEPWELL	291
28 660 129	81.61510.0129	STEPWELL LEFT	295
28 660 130	81.61510.0130	STEPWELL	291
28 660 141	81.61510.0158	STEPWELL	292
28 660 142	81.61510.0159	STEPWELL	292
28 660 161	81.61510.5161	TRIM	301
28 660 162	81.61510.5162	TRIM	301
28 660 163	81.61510.5163	TRIM	301
28 660 164	81.61510.5164	TRIM	302
28 660 181	81.61510.5181	STEPWELL	292
28 660 196	81.61510.5196	STEP	288
28 660 197	81.61510.5197	STEP	288
28 660 225	81.61510.0225	STEPWELL	292
28 660 226	81.61510.0226	STEPWELL	293
28 660 229	81.61510.0229	STEPWELL	293
28 660 230	81.61510.0230	STEPWELL	293
28 660 262	81.61510.0262	STEP	289

Umschlüsselung / Cross Referenz

AL-HU TECH	MAN	Description	Page
28 660 263	81.61510.0263	STEP	289
28 660 267	81.61510.0267	STEP	289
28 660 268	81.61510.0268	STEP	289
28 660 333	81.61510.0333	STEPWELL	293
28 660 374	81.61510.0374	STEPWELL	294
28 660 401	81.61510.0401	STEPWELL	294
28 660 402	81.61510.0402	STEPWELL RIGHT	295
28 660 408	81.61510.0408	MUDGUARDS EXTENSION, RIGHT	274
28 660 409	81.61510.0409	MUDGUARDS EXTENSION, LEFT	274
28 660 536	81.61510.0536	COVER STEPWELL	232
28 663 022	51.06630.7022	SUPPORTING ARM	443
28 666 001	81.61511.0001	STEP	290
28 666 187	81.61510.5187	STEP LOWER	290
28 666 273	81.61510.0273	STEP UPPER	291
28 666 355	81.61510.0355	STEPWELL	294
28 666 382	81.61510.0382	STEPWELL	294
28 670 011	81.62670.6011	DOOR ARRESTOR	233
28 692 001	81.62692.5001	SUPPORT	297
28 701 021	81.63701.0021	SUN VISOR	296
28 720 001	81.96120.0001	WEATHERSTRIP	304
28 720 002	81.96120.0002	WEATHERSTRIP	304
28 720 020	81.62630.6020	DOOR PANNELING	239
28 720 021	81.62630.6021	DOOR PANELLING	238
28 720 042	81.62690.0042	HINGE PART	254
28 720 047	81.62690.0047	HINGE PART	254
28 720 077	81.62600.4087	DOOR IN WHITE	236
28 720 078	81.62600.4088	DOOR IN WHITE	236
28 720 099	81.62641.0099	DOOR HANDLE	234
28 720 100	81.62641.0100	DOOR HANDLE	234
28 720 101	81.62641.0101	PULL HANDLE	277
28 721 046	81.62640.6057	WINDOW REGULATOR	309
28 721 146	81.62640.6058	WINDOW REGULATOR	310
28 723 007	81.62691.0007	PIN	275
28 723 046	81.62690.0046	BUSH	218
28 723 055	81.62680.0055	STRIKER PLATE	295
28 723 107	81.62680.6107	DOOR LOCK	237
28 723 108	81.62680.6108	DOOR LOCK	237
28 725 047	81.62630.0047	WINDOW FRAME, LEFT	307
28 725 048	81.62630.0048	WINDOW FRAME, RIGHT	308
28 742 004	81.74249.6004	WINDOW MOTOR	308
28 742 005	81.74249.6005	WINDOW MOTOR	308
28 760 052	81.62641.6052	WINDOW CRANK	307
28 790 048	81.62410.0048	WIND DEFLECTOR RIGHT	306
28 790 049	81.62410.0049	WIND DEFLECTOR LEFT	305
28 790 063	81.62410.0063	WIND DEFLECTOR LEFT	306
28 790 064	81.62410.0064	WIND DEFLECTOR RIGHT	306
28 804 008	51.01804.0008	PRESSURE REGULATING VALVE	426
28 810 294	81.63730.6294	MIRROR	262
28 810 368	81.63730.6364	MIRROR	262
28 810 368	81.63730.6368	MIRROR	262
28 810 489	81.63731.6489	MIRROR BRACKET	264
28 810 490	81.63731.6490	MIRROR BRACKET	264
28 811 009	85.63710.0009	MIRROR COVER	267
28 811 010	85.63710.0010	MIRROR COVER	267

Umschlüsselung / Cross Referenz

AL-HU TECH	MAN	Description	Page
28 820 001	81.26401.6051	WIPER MOTOR	315
28 820 002	81.26401.6118	WIPER MOTOR	316
28 820 003	81.26401.6127	WIPER MOTOR	316
28 820 004	81.26401.6137	WIPER MOTOR	316
28 820 005	81.26401.6141	WIPER MOTOR	316
28 820 006	81.26430.6057	WIPER ARM	312
28 820 007	81.26430.6059	WIPER ARM	312
28 820 008	81.26430.6058	WIPER ARM	313
28 820 009	81.26411.6092	WIPER LINKAGE	314
28 820 010	81.25505.0989	DOOR CONTACT SWITCH	474
28 820 011	81.26411.6112	WIPER LINKAGE	314
28 820 083	81.26430.0083	WIPER ARM	313
28 820 085	81.25102.6085	FOG LAMP	242
28 820 089	81.26411.6089	WIPER LINKAGE	314
28 820 090	81.26411.6090	WIPER LINKAGE	315
28 820 091	81.26411.6091	WIPER LINKAGE	315
28 820 101	81.25260.6101	SIDE MARKER LIGHT	287
28 820 111	81.26411.6111	WIPER LINKAGE	315
28 820 142	81.26401.6119	WIPER MOTOR	317
28 820 289	81.25101.6289	HEAD LAMP	249
28 820 290	81.25101.6290	HEAD LAMP	250
28 820 291	81.25101.6291	HEAD LAMP	250
28 820 292	81.25101.6292	HEAD LAMP	250
28 820 338	81.25101.6338	HEADLIGHTS AND FOGLIGHTS RIGHT	253
28 820 338	81.25113.6022	HEADLIGHTS AND FOGLIGHTS RIGHT	253
28 820 339	81.25101.6339	HEADLIGHTS AND FOGLIGHTS LEFT	252
28 820 339	81.25113.6021	HEADLIGHTS AND FOGLIGHTS LEFT	252
28 820 340	81.25115.0023	RETAINING FRAME, LEFT	281
28 820 341	81.25115.0022	RETAINING FRAME, RIGHT	281
28 820 448	81.25101.6448	HEAD LAMP	250
28 820 449	81.25101.6449	HEAD LAMP	251
28 820 450	81.25101.6450	HEAD LAMP	251
28 820 451	81.25101.6451	HEAD LAMP	251
28 826 067	81.25110.0067	HEAD LAMP LENS	251
28 826 068	81.25110.0068	HEAD LAMP LENS	252
28 826 080	81.25110.0080	HEAD LAMP LENS	252
28 826 081	81.25110.0081	HEAD LAMP LENS	252
28 826 089	81.25320.6089	BLINKER LAMP	205
28 826 090	81.25320.6090	BLINKER LAMP	205
28 826 104	81.25260.6104	SIDE MARKER LAMP	287
28 826 111	81.25320.6091	BLINKER LAMP	205
28 826 111	81.25320.6111	BLINKER LAMP	205
28 826 112	81.25320.6092	BLINKER LAMP	206
28 826 112	81.25320.6112	BLINKER LAMP	206
28 826 113	81.25320.6113	BLINKER LAMP	206
28 826 114	81.25320.6114	BLINKER LAMP	206
28 826 117	81.25320.6117	BLINKER LAMP	206
28 826 118	81.25320.6118	BLINKER LAMP	207
28 830 003	81.61930.6098	BLOWER MOTOR	208
28 830 028	81.08201.6028	INTAKE PIPE	256
28 830 064	81.61901.0064	HEAT EXCHANGER	253
28 830 065	81.61901.0065	HEAT EXCHANGER	253
28 830 066	81.61901.6166	HEAT EXCHANGER	253
28 830 067	81.61901.0067	HEAT EXCHANGER	254

Umschlüsselung / Cross Referenz

AL-HU TECH	MAN	Description	Page
28 830 108	81.61930.0055	BLOWER MOTOR	208
28 830 208	81.61930.0042	BLOWER MOTOR	208
28 830 308	81.61930.0036	BLOWER MOTOR	209
28 830 332	81.08201.0332	HOSE BEND	255
28 831 108	81.28601.6011	BLOWER MOTOR	209
28 869 008	81.26485.6008	WINDSHIELD WASHER PUMP	311
28 869 033	81.26485.6033	WINDSHIELD WASHER PUMP	311
28 869 221	81.26485.6016	WINDSHIELD WASHER PUMP	311
28 869 321	81.26485.6027	WINDSHIELD WASHER PUMP	312
28 880 005	81.97006.0003	GAS SPRING	244
28 880 016	81.61140.0016	GAS SPRING	244
28 880 020	81.61967.0020	EXPANSION VALVE	239
28 880 022	81.61967.6022	CONTROL VALVE	229
28 880 028	81.97122.0028	LOCK, GRILL	259
28 880 035	81.41613.5035	AIRDAM MOUNTING	204
28 880 044	81.41685.0044	TRIM	302
28 880 050	81.61150.6050	RADIATOR GRILLE	277
28 880 051	81.61150.6051	RADIATOR GRILLE	277
28 880 061	81.41615.5061	FOOTHOLD	243
28 880 071	81.41613.0071	AIR DAM 350 MM	202
28 880 073	81.41613.0073	AIR DAM 250 MM	202
28 880 074	81.41613.0074	AIR DAM 190 MM	202
28 880 076	81.41613.0076	AIRDAM END PANEL RIGHT	203
28 880 077	81.41613.0077	AIRDAM END PANEL LEFT	202
28 880 078	81.41613.0078	AIRDAM END PANEL RIGHT	203
28 880 079	81.41613.0079	AIRDAM END PANEL, LEFT	203
28 880 080	81.41613.0080	AIRDAM END PANEL, RIGHT	204
28 880 081	81.41613.0081	AIRDAM END PANEL, LEFT	203
28 880 086	81.66410.0086	MUDGUARD	271
28 880 095	81.74821.0095	GAS SPRING	245
28 880 114	81.41610.4114	BUMPER	214
28 880 149	81.74821.0149	GAS SPRING	245
28 880 150	81.41610.0150	FLAP, LOWER	240
28 880 151	81.41610.0151	BUMPER END PANEL	217
28 880 152	81.41610.0152	BUMPER END PANEL	217
28 880 158	81.41610.0158	COVER	231
28 880 159	81.41610.0159	COVER	231
28 880 164	81.41610.0164	TRIM	302
28 880 166	81.41610.0166	TRIM	302
28 880 167	81.41610.0167	TRIM	303
28 880 191	81.41610.0191	FLAP, UPPER	240
28 880 227	81.41610.0227	CORNER LEFT	230
28 880 228	81.41610.0228	CORNER RIGHT	231
28 880 305	81.41610.0305	BUMPER	214
28 880 306	81.41610.0306	BUMPER	214
28 880 310	81.61210.5310	MUDGUARD	271
28 880 311	81.61210.5311	MUDGUARD	271
28 880 352	81.66410.0352	MUDGUARD	271
28 880 353	81.66410.0353	MUDGUARD	272
28 880 363	81.61210.5363	MUDGUARD	272
28 880 425	81.96002.0425	CAP, BUMPER	227
28 881 046	81.42950.0046	REFLECTOR	278
28 881 060	81.42950.0060	REFLECTOR	278
28 881 066	81.61230.0066	GUARD PLATE RIGHT	249

Umschlüsselung / Cross Referenz

AL-HU TECH	MAN	Description	Page
28 881 067	81.61230.0067	GUARD PLATE LEFT	249
28 881 071	81.42950.0071	REFLECTOR YELLOW	278
28 881 080	81.66410.5080	MUDGUARD	272
28 881 081	81.66410.5081	MUDGUARD	272
28 888 043	81.61110.0043	FRONT SERVICE DOOR, WIDE	244
28 888 053	81.61110.0053	FRONT SERVICE DOOR	244
28 888 060	81.61150.5060	RADIATOR GRILLE	277
28 890 003	81.41722.6077	CABIN SHOCK ABSORBER	225
28 890 003	85.41722.6022	CABIN SHOCK ABSORBER	225
28 890 004	81.41722.6058	CABIN SHOCK ABSORBER	225
28 890 005	81.41722.6057	CABIN SHOCK ABSORBER	225
28 890 005	81.41722.6073	CABIN SHOCK ABSORBER	225
28 890 012	81.41722.6012	CABIN SHOCK ABSORBER	226
28 890 013	81.41715.6013	REP. KIT CABIN MOUNTING	280
28 890 014	81.41715.6014	REP. KIT CABIN MOUNTING	280
28 890 051	81.41722.6051	CABIN SHOCK ABSORBER	226
28 890 052	81.41722.6052	CABIN SHOCK ABSORBER	226
28 890 274	81.96210.0274	CABIN MOUNTING	222
28 890 400	81.96210.0400	CABIN MOUNTING	222
28 890 407	81.96210.0407	CABIN MOUNTING	222
28 890 407S	81.96210.0407	CABIN MOUNTING KIT	224
28 890 462	81.96210.0462	CABIN MOUNTING	223
28 890 515	81.96210.0515	CABIN MOUNTING	223
28 890 536	81.96210.0536	CABIN MOUNTING	223
28 891 013	81.41722.6013	CABIN SHOCK ABSORBER	226
28 971 034	81.97100.6034	LOCK SET	258
28 971 098	81.97100.6098	LOCK SET	258
28 971 099	81.97100.6099	DOOR HANDLE	234
28 988 760	81.61444.0003	GLOVE BOX LOCK	248
29 255 006	81.15408.0006	FLUID LEVEL PROBE	474
29 255 034	81.25509.0034	STEERING COLUMN SWITCH	495
29 255 035	81.25514.0035	PRESSURE SWITCH	480
29 255 050	81.25509.0050	STEERING COLUMN SWITCH	496
29 255 054	81.25509.0054	STEERING COLUMN SWITCH	496
29 255 069	81.25509.0069	RETARDER SWITCH	486
29 255 070	81.25509.0070	BRAKE SWITCH	470
29 255 071	81.25509.0071	RETARDER SWITCH	486
29 255 072	81.25509.0072	RETARDER SWITCH	486
29 255 073	81.25509.0073	RETARDER SWITCH	487
29 255 075	81.25509.0075	RETARDER SWITCH	487
29 255 076	81.25509.0076	RETARDER SWITCH	487
29 255 078	81.25509.0078	STEERING COLUMN SWITCH	496
29 255 079	81.25509.0079	STEERING COLUMN SWITCH	496
29 255 084	81.25509.0084	RETARDER SWITCH	487
29 255 088	81.25520.0088	BRAKE SWITCH	470
29 255 089	81.25520.0089	SENSOR	491
29 255 100	81.25520.0100	CONTROL SWITCH	471
29 255 104	81.25520.0104	CONTROL SWITCH	472
29 255 106	81.25520.0106	CONTROL SWITCH	472
29 255 107	81.25520.0107	CONTROL SWITCH	472
29 255 117	81.25520.0117	CONTROL SWITCH	472
29 255 125	81.25509.0125	EXHAUST BRAKE SWITCH	474
29 255 126	81.25509.0126	STEERING COLUMN SWITCH	497
29 255 127	81.25509.0127	STEERING COLUMN SWITCH	497

Umschlüsselung / Cross Referenz

AL-HU TECH	MAN	Description	Page
29 255 129	81.25509.0129	STEERING COLUMN SWITCH	497
29 255 130	81.25509.0130	STEERING COLUMN SWITCH	497
29 255 131	81.25505.6131	BRAKE SWITCH	470
29 255 139	81.25509.0139	STEERING COLUMN SWITCH	498
29 255 146	81.27202.6146	INDICATOR	477
29 255 148	81.25509.0148	STEERING COLUMN SWITCH	498
29 255 149	81.25520.0149	BRAKE SWITCH	470
29 255 151	51.27421.0151	TEMPERATURE SENDER	498
29 255 152	81.25520.0152	BRAKE SWITCH	471
29 255 162	81.25520.0162	CONTROL SWITCH	473
29 255 163	81.25520.0163	PRESSURE SWITCH	481
29 255 167	81.25520.0167	PRESSURE SWITCH	481
29 255 169	81.25520.0169	SENSOR	491
29 255 171	81.25520.0171	BRAKE LIGHT SWITCH	469
29 255 172	81.25520.0172	SENSOR	491
29 255 173	81.25520.0173	SENSOR	491
29 255 175	81.25505.6175	RETARDER SWITCH	488
29 255 176	81.25520.0076	CONTROL SWITCH	473
29 255 177	81.25520.0177	PRESSURE SWITCH	481
29 255 179	81.25520.0079	CONTROL SWITCH	471
29 255 184	81.25520.0184	PRESSURE SWITCH	481
29 255 187	81.25520.0187	PRESSURE SWITCH	482
29 255 190	81.25520.0190	PRESSURE SWITCH	482
29 255 191	81.25520.0191	PRESSURE SWITCH	482
29 255 195	81.25520.0195	PRESSURE SWITCH	482
29 255 204	81.27421.0204	SENSOR	492
29 255 209	81.25520.0209	PRESSURE SWITCH	483
29 255 210	81.25520.0210	PRESSURE SWITCH	483
29 255 214	81.25520.0214	SENSOR	492
29 255 231	81.27421.0231	VACUUM SWITCH	507
29 255 267	81.25902.6267	RELAY	485
29 255 268	81.25902.6268	RELAY	485
29 255 276	81.25520.0176	SENSOR	492
29 255 295	81.25907.0295	POTENTIOMETER	479
29 255 706	81.25935.6706	ELECTRONIC CONTROL	474
29 255 959	81.25505.0959	ROTARY SWITCH	490
29 255 975	81.25505.0975	ROTARY SWITCH	490
29 255 976	81.25505.0976	ROTARY SWITCH	490
29 288 287	81.25907.0287	POTENTIOMETER	479
29 421 077	81.27421.0227	PRESSURE SENSOR	480
29 421 113	51.27421.0113	TEMPERATURE SENSOR	500
29 421 135	81.27421.0135	PULSE GENERATOR	484
29 421 137	81.27421.0137	PULSE GENERATOR	484
29 421 151	81.27421.0151	PRESSURE SENSOR	480
29 421 264	81.27421.0264	TEMPERATURE SENSOR	500
29 503 244	81.25503.0244	PRESSURE SWITCH	483
29 525 032	81.25525.0032	REVERSE LIGHT SWITCH	489
29 525 033	81.25525.0033	REVERSE LIGHT SWITCH	489
29 525 033	81.25525.0227	REVERSE LIGHT SWITCH	489
29 525 033	81.25525.0257	REVERSE LIGHT SWITCH	489
29 525 156	81.25525.0156	REVERSE LIGHT SWITCH	489
29 542 819	81.25902.0203	STARTER INTERLOCK	169
29 545 005	81.25505.0461	REVERSE LIGHT SWITCH	489
29 545 006	81.27430.0005	OIL PRESSURE SWITCH	479

Umschlüsselung / Cross Referenz

AL-HU TECH	MAN	Description	Page
29 545 007	81.25505.0992	FOOT BRAKE SWITCH	475
29 545 012	81.27421.0125	TEMPERATURE SENDER	498
29 545 014	81.27420.0085	TEMPERATURE SENSOR	500
29 943 009	81.25943.6009	TRANSFORMER 24>12V DC	507
61 451 395	81.61967.0010	EXPANSION VALVE	378
61 451 396	83.77953.6501	DRYER BOTTLE	359
63 450 001	81.39126.6009	UNIVERSAL JOINT	82
63 450 002	81.39126.6030	UNIVERSAL JOINT	82
63 450 003	81.39410.6028	INTERMEDIATE BEARING	31
63 450 004	81.39126.6033	UNIVERSAL JOINT	82
63 450 004	81.39374.6004	UNIVERSAL JOINT	82
63 450 008	81.27421.0189	WATER LEVEL SENSOR	507
63 450 009	88.25311.0002	CONTROL UNIT	473
63 450 010	81.27421.0152	WATER LEVEL SENSOR	507
63 450 011	81.25935.6534	RELAY	439
63 450 013	81.39115.5061	DRIVING FLANGE	25
63 450 015	81.39374.6001	UNIVERSAL JOINT	83
63 450 016	81.39100.6007	UNIVERSAL JOINT	83
63 450 017	81.39108.6052	UNIVERSAL JOINT	83
63 450 018	81.39410.6032	PROPELLER SHAFT BEARING	42
63 450 021	81.39108.6050	UNIVERSAL JOINT	83
63 450 021	81.39108.6055	UNIVERSAL JOINT	83
63 450 021	81.99917.8469	UNIVERSAL JOINT	83
63 450 023	81.41722.6050	CABIN SHOCK ABSORBER	227
63 450 028	81.39126.6029	UNIVERSAL JOINT	84
63 450 034	81.43701.6714	SHOCK ABSORBER	55
63 450 035	81.43701.6893	SHOCK ABSORBER	55
63 450 037	81.43701.6890	SHOCK ABSORBER	55
63 450 038	81.43701.6794	SHOCK ABSORBER	55
63 450 039	81.43701.6911	SHOCK ABSORBER	56
63 450 040	81.43701.6927	SHOCK ABSORBER	56
63 450 048	81.96210.0242	ENGINE MOUNTING	363
63 450 049	81.96210.0379	RUBBER MOUNTING	45
63 450 050	81.43701.6793	SHOCK ABSORBER	56
63 450 060	81.27421.0232	FLUID LEVEL PROBE	475
63 450 065	81.43701.6713	SHOCK ABSORBER	56
63 450 066	81.43701.6715	SHOCK ABSORBER	57
63 450 067	81.36415.6035	UNIVERSAL JOINT	84
63 450 068	81.39108.6053	UNIVERSAL JOINT	84
63 450 069	81.39115.5068	DRIVING FLANGE	25
63 450 070	51.05601.0148	OIL COOLER	415
63 450 076	81.96340.0902	AIRCOIL	117
63 450 077	81.43701.6830	SHOCK ABSORBER	57
63 450 078	81.43701.6924	SHOCK ABSORBER	57
63 450 079	81.39335.6110	PROPELLER SHAFT	40
63 450 080	81.96210.0508	RUBBER MOUNTING	46
63 450 081	81.43701.6900	SHOCK ABSORBER	57
63 450 082	85.41722.6010	SHOCK ABSORBER	58
63 450 085	81.96210.0479	RUBBER BUFFER	44
63 450 086	81.91710.0357	GUIDE RING	190
63 450 087	81.96210.0364	CABIN MOUNTING	17
63 450 088	81.96210.0574	ENGINE MOUNTING	27
63 450 089	81.96210.0597	ENGINE MOUNTING	27
63 450 090	81.96210.6072	ENGINE MOUNTING	28

Umschlüsselung / Cross Referenz

AL-HU TECH	MAN	Description	Page
63 450 091	81.96420.0529	BELLOW	15
63 450 092	06.54059.0012	HOSE PIPE	131
63 450 093	81.41700.6095	REP. KIT, CAB SUSPENSION	280
63 450 094	81.43402.6225	PARABOLIC SPRING	39
63 450 095	81.25503.6243	PUSH BUTTON SWITCH	485
63 450 097	81.25320.6095	FLASHER LAMP	241
63 450 098	81.25229.6042	REAR LAMP LENS	278
63 450 099	81.25260.6039	BLINKER LAMP	207
63 450 100	81.25320.6096	FLASHER LAMP	241
63 450 101	81.45950.0004	COVER PLATE RAL9006	232
63 450 102	81.35604.0017	OUTPUT SHAFT	38
63 450 103	81.39115.0207	DRIVING FLANGE	26
63 450 104	81.35614.0001	SELECTOR FORK	54
63 450 105	81.35631.0006	SHIFT CYLINDER	54
63 450 106	85.41722.6023	CABIN SHOCK ABSORBER	227
63 450 107	81.39410.6037	PROPELLER SHAFT BEARING	42
63 450 110	81.25320.6088	BLINKER LAMP	207
63 450 111	81.32545.0033	LATCH STOP	191
63 450 112	81.93020.0525	BUSH	176
63 450 113	85.90710.0014	STOP WASHER	78
63 450 114	81.63731.0356	MIRROR CAP	265
63 450 115	81.41723.0067	BUSH, CABIN TILT	218
63 450 116	81.43701.6964	SHOCK ABSORBER	58
63 450 117	81.43701.6948	SHOCK ABSORBER	58
63 450 118	51.06601.0261	FAN BLADE	384
63 450 119	06.21569.0066	CLEVIS PIN	144
63 450 120	85.96020.0004	CABIN MOUNTING	223
63 450 128	06.21569.0077	CLEVIS PIN	144
63 450 129	88.96210.0057	RUBBER BUFFER	282
63 450 131	81.95301.6288	BALL JOINT	318
63 450 134	85.96210.0030	CABIN MOUNTING	224
63 450 136	81.96210.0406	ENGINE MOUNTING	239
63 450 136	81.96210.0604	ENGINE MOUNTING	239
63 450 138	81.43701.6842	SHOCK ABSORBER	58
63 450 139	81.43722.0019	STABILIZER MOUNTING	76
63 450 140	81.96503.0226	SQUARE SEAL	442
63 450 141	81.52161.6318	PRESSURE LIMITER VALVE	426
63 450 142	81.46109.0038	STEERING BUSHING	328
63 450 150	06.33719.0057	NEEDLE SLEEVE	38
63 450 151	81.41700.6096	REPAIR KIT	43
63 450 152	81.52116.6070	RELAY VALVE	134
63 450 155	81.43603.0044	AIR SPRING BASE	2
63 450 158	81.39324.6068	PROPELLER SHAFT	41
63 450 159	81.39324.6070	PROPELLER SHAFT	41
63 450 160	81.46711.6921	TIE ROD	330
63 450 162	04.27405.9550	RADIATOR HOSE	435
63 450 163	81.93020.0986	BUSH	176
63 450 183	81.43603.0062	AIR SPRING BASE	2
63 450 184	81.43603.0041	AIR SPRING BASE	2
63 450 185	81.43603.0055	AIR SPRING BASE	3
63 450 186	81.43603.0060	AIR SPRING BASE	3
63 450 191	81.52151.6073	4-CIRCUIT PROTECTION VALVE	143
63 450 192	81.90620.0092	LOCK RING M100X1,5	37
63 450 193	06.36950.0508	BEARING BUSH	14

Umschlüsselung / Cross Referenz

AL-HU TECH	MAN	Description	Page
63 450 194	81.96210.0603	CABIN MOUNTING	18
63 450 196	85.41722.6011	SHOCK ABSORBER	59
63 450 197	81.95301.6248	BALL JOINT	318
63 450 198	81.52315.6086	HAND BRAKE VALVE	130
63 450 198	81.52315.6090	HAND BRAKE VALVE	130
63 450 199	81.52130.6106	FOOT BRAKE VALVE	129
63 450 200	81.96210.0247	RUBBER MOUNTING	283
63 450 204	51.96420.0121	TURBO HOSE	452
63 450 205	81.77930.6034	BLOWER MOTOR	209
63 450 205	81.77930.6050	BLOWER MOTOR	209
63 450 207	81.25225.6459	FLASHER LAMP	241
63 450 208	81.25225.6460	FLASHER LAMP	242
63 450 209	81.25225.6511	TAIL LAMP	299
63 450 210	81.25225.6510	TAIL LAMP	299
63 450 211	81.25260.6074	CLEARANCE LAMP	228
63 450 212	81.25225.6485	CLEARANCE LAMP	228
63 450 213	81.27421.0088	OIL PRESSURE SENDER	478
63 450 214	51.27420.7005	TEMPERATURE SENDER	499
63 450 215	36.97116.0000	SNAP LOCK	288
63 450 215	81.97116.0099	SNAP LOCK	288
63 450 216	81.96101.0733	WEATHERSTRIP	304
63 450 217	81.96101.0732	WEATHERSTRIP	304
63 450 232	81.25101.6521	FOG LAMP	242
63 450 233	81.25101.6522	FOG LAMP	242
63 450 234	81.25110.0085	FOG LAMP LENS	243
63 450 235	81.25110.0086	FOG LAMP LENS	243
63 450 236	81.26100.6029	REPAIR KIT	167
63 450 237	51.26105.0247	V-BELT PULLEY	460
63 450 239	81.43704.0076	STABILIZER MOUNTING	77
63 450 240	81.74940.6420	ROLLER GUIDE	282
63 450 241	81.74940.6421	ROLLER GUIDE	282
63 450 242	51.54206.0004	FOLLOWER	128
63 450 243	81.43220.6215	CONTROL ARM	24
63 450 244	51.54122.0007	RELIEF VALVE	135
63 450 246	81.26421.6042	WIPER BEARING	313
63 450 247	51.95800.7088	BELT TENSIONER	339
63 450 248	81.46611.6016	DRAG LINK	323
63 450 249	51.54210.0109	DRIVE GEAR	357
63 450 250	51.04203.5058	ROCKER SHAFT	440
63 450 251	51.98110.0177	T JUNCTION	443
63 450 252	51.06650.0005	DRIVE SHAFT	358
63 450 254	81.95820.0267	V-BELT PULLEY	460
63 450 255	81.06606.0147	V-BELT PULLEY	460
63 450 256	51.54201.0112	V-BELT PULLEY	460
63 450 257	51.90310.0255	DRAIN PLUG	357
63 450 279	81.62651.0075	SEALING FRAME	284
63 450 280	81.91605.0041	COVER	232
63 450 281	51.90490.0032	HEX. SCREW	406
63 450 283	81.43402.6058	PARABOLIC SPRING	39
63 450 323	06.01494.7317	HEX SHOULDER STUD	30
63 450 442	81.43220.6174	CONTROL ARM	320
63 450 443	81.43250.6007	CONTROL ARM	320
63 450 444	81.46610.6288	DRAG LINK	323
63 450 445	81.46611.6006	DRAG LINK	324

Umschlüsselung / Cross Referenz

AL-HU TECH	MAN	Description	Page
63 450 446	81.46611.6019	DRAG LINK	324
63 450 447	81.46611.6150	DRAG LINK	324
63 450 448	81.46611.6201	DRAG LINK	324
63 450 449	81.46710.6372	TIE ROD	331
63 450 450	81.46711.6712	TIE ROD	331
63 450 451	81.46711.6715	TIE ROD	331
63 450 452	81.46711.6728	TIE ROD	331
63 450 453	81.46711.6729	TIE ROD	332
63 450 454	81.46711.6759	TIE ROD	332
63 450 455	81.95301.0040	BALL JOINT	318
63 450 456	81.95301.6263	BALL JOINT	319
63 450 457	81.95301.6286	BALL JOINT	319
63 450 458	85.96210.0039	RUBBER BUFFER	44
63 450 459	81.95301.6321	BALL JOINT	319
63 450 460	81.95301.6322	BALL JOINT	319
63 450 461	82.46610.6184	DRAG LINK	325
63 450 462	85.46610.6102	DRAG LINK	325
63 450 463	85.46610.6104	DRAG LINK	325
63 450 464	85.46610.6140	DRAG LINK	325
63 450 465	85.46610.6163	DRAG LINK	326
63 450 466	85.46610.6244	DRAG LINK	326
63 450 467	85.46610.6246	DRAG LINK	326
63 450 468	85.46610.6247	DRAG LINK	326
63 450 481	81.96210.0063	PROPELLER SHAFT MOUNTING	43
63 450 540	81.96210.0540	RUBBER MOUNTING	46
63 450 541	81.96210.0367	ENGINE MOUNTING	28
63 450 552	81.74364.0009	RETAINING PLATE	281
63 450 555	81.39108.6229	UNIVERSAL JOINT	84
63 450 568	83.78611.6001	REPAIR KIT	279
63 450 570	81.43603.0047	AIR SPRING BASE	3
63 450 571	85.43704.0005	STABILIZER MOUNTING	77
63 450 572	81.43722.0091	STABILIZER MOUNTING	77
63 450 575	85.41610.4013	COVERING	232
63 450 576	81.41610.0160	TRIM RIGHT	303
63 450 577	81.41610.0161	TRIM LEFT	303
63 450 579	81.43722.0092	STABILIZER MOUNTING	77
63 450 586	06.67124.1024	HOSE CLAMP	407
63 450 587	06.54059.0007	HOSE PIPE	408
63 450 588	06.43809.0176	LOCKING PIN	153
63 450 589	06.36099.0002	BALL SOCKET	336
63 450 590	06.08049.0004	DRAIN PLUG	357
63 450 591	06.02819.0005	LOCK SCREW	152
63 450 592	06.02816.1413	LOCK SCREW	153
63 450 593	06.02202.4212	HEX COLLAR BOLT	147
63 450 594	06.01493.4932	HEX SHOULDER STUD DIN 960	151
63 450 595	51.01901.0129	TIMING CASE GASKET	447
63 450 596	51.02201.0081	VIBRATION DAMPER	456
63 450 597	51.02201.0091	VIBRATION DAMPER	457
63 450 598	51.04501.0144	CAMSHAFT GEAR	346
63 450 599	51.04505.0108	CAMSHAFT GEAR	346
63 450 600	51.04505.5061	CAMSHAFT GEAR	346
63 450 601	51.05201.0073	OIL PUMP GEAR	422
63 450 602	51.05503.6105	OIL FILTER HEAD	419
63 450 603	51.05503.6093	OIL FILTER HEAD	419

Umschlüsselung / Cross Referenz

AL-HU TECH	MAN	Description	Page
63 450 604	51.05503.6106	OIL FILTER HEAD	419
63 450 605	51.05805.5304	OIL DIPSTICK	416
63 450 606	51.05805.5558	OIL DIPSTICK	416
63 450 607	51.05805.5578	OIL DIPSTICK	416
63 450 608	51.05805.5608	OIL DIPSTICK	417
63 450 609	51.05805.5695	OIL DIPSTICK	417
63 450 610	51.05805.5744	OIL DIPSTICK	417
63 450 611	51.05904.0197	OIL PAN GASKET	420
63 450 612	51.06301.0854	THERMOSTAT COVER	445
63 450 613	51.06301.0950	COOLING WATER PIPE	351
63 450 614	51.06301.5725	COOLANT ELBOW	350
63 450 615	51.06302.0259	COOLANT ELBOW	350
63 450 616	51.06606.0062	V-BELT PULLEY	461
63 450 617	51.06606.0097	V-BELT PULLEY	461
63 450 618	51.06903.0030	WATER PIPE GASKET	461
63 450 619	51.08101.0609	EXHAUST MANIFOLD	370
63 450 620	51.08101.0610	EXHAUST MANIFOLD	370
63 450 621	51.08101.0630	EXHAUST MANIFOLD	370
63 450 622	51.08101.0631	EXHAUST MANIFOLD	370
63 450 623	51.08101.0683	EXHAUST MANIFOLD	371
63 450 624	51.08101.0704	EXHAUST MANIFOLD	371
63 450 625	51.08901.0200	EXHAUST MANIFOLD GASKET	372
63 450 626	51.08902.0179	INLET MANIFOLD GASKET	412
63 450 627	51.09402.0030	TURBO HOSE	452
63 450 628	51.09901.0036	TURBO GASKET	448
63 450 629	51.10303.6107	INJECTION LINE SET	411
63 450 630	51.10303.6236	INJECTION LINE SET	411
63 450 631	51.11301.0090	DRIVE GEAR	357
63 450 632	51.11301.0159	DRIVE GEAR	358
63 450 633	51.12504.0008	FILTER HEAD	390
63 450 634	51.12504.6003	FILTER HEAD	391
63 450 635	51.12504.6004	FILTER HEAD	391
63 450 636	51.15201.6183	EXHAUST ELBOW	367
63 450 637	51.15901.0012	EXHAUST GASKET	367
63 450 639	51.90441.0114	EYE BOLT	378
63 450 640	51.90441.0127	EYE BOLT	379
63 450 641	51.91701.0704	RACE	428
63 450 642	51.95800.7466	BELT TENSIONER	339
63 450 643	51.95801.6018	BELT TENSIONER PULLEY	340
63 450 644	51.26105.0301	V-BELT PULLEY	461
63 450 645	51.95801.6019	BELT TENSIONER PULLEY	340
63 450 646	51.95840.0172	BELT TENSIONER PULLEY ARM	341
63 450 647	51.97141.0016	RADIATOR CAP	429
63 450 648	51.97445.0033	PROFIED CLAMP	427
63 450 649	51.97445.0076	PROFIED CLAMP	427
63 450 650	51.98150.0110	HOLLOW SCREW	407
63 450 651	81.06110.0007	RADIATOR CAP	429
63 450 652	81.06225.6008	RADIATOR MOUNTING	438
63 450 653	81.10109.0024	NOZZLE CAP NUT	414
63 450 654	81.10109.0032	NOZZLE CAP NUT	414
63 450 655	81.12501.6082	FUEL PREFILTER	401
63 450 656	81.12504.6011	FUEL PREFILTER COVER	401
63 450 657	81.12510.0027	FUEL PREFILTER VALVE	401
63 450 658	81.15701.6119	AIR CYLINDER	335

Umschlüsselung / Cross Referenz

AL-HU TECH	MAN	Description	Page
63 450 659	81.15701.6124	AIR CYLINDER	336
63 450 660	81.25140.0096	LOCK PLATE	258
63 450 661	81.25140.0121	BRACKET	212
63 450 662	81.25225.6259	TAIL LAMP	299
63 450 663	81.25225.6260	TAIL LAMP	299
63 450 664	81.25245.0144	BRACKET	212
63 450 665	81.25320.6043	BLINKER LAMP	207
63 450 666	81.26430.0081	WIPER ARM	313
63 450 667	81.27120.0016	PULSE GENERATOR	484
63 450 668	81.30550.0050	CLUTCH RELEASE BEARING	184
63 450 669	81.30550.0056	CLUTCH RELEASE BEARING	184
63 450 670	81.30550.0251	CLUTCH RELEASE BEARING	184
63 450 671	81.30715.6104	REPAIR KIT	192
63 450 672	81.30715.6117	CLUTCH MASTER CYLINDER	181
63 450 673	81.30715.6126	REPAIR KIT	193
63 450 674	81.30716.6044	CLUTCH SLAVE CYLINDER	186
63 450 675	81.30716.6057	CLUTCH SLAVE CYLINDER	186
63 450 676	81.30716.6071	REPAIR KIT	193
63 450 677	81.30716.6082	CLUTCH SLAVE CYLINDER	186
63 450 678	81.32616.0011	INSULATING ELEMENT	191
63 450 679	81.32620.0101	GEARSHIFT LEVER COVER	189
63 450 680	81.32620.0102	GEARSHIFT LEVER COVER	189
63 450 681	81.32620.0106	GEARSHIFT LEVER HANDLE	189
63 450 682	81.32655.6072	BOWDEN CABLE	210
63 450 683	81.32655.6074	BOWDEN CABLE	210
63 450 684	81.32655.6180	REPAIR KIT GEAR SHIFT COVER	193
63 450 685	81.35401.0135	TRUNNION	81
63 450 686	81.39115.5042	DRIVING FLANGE	26
63 450 687	81.44215.0017	THRUST WASHER	80
63 450 688	81.46105.6015	UNIVERSAL JOINT	333
63 450 689	81.51401.0129	AIR TANK	117
63 450 690	81.51401.0133	AIR TANK	117
63 450 691	81.62540.7000	STRIKER PLATE LEFT	295
63 450 692	81.62540.7001	STRIKER PLATE RIGHT	296
63 450 693	81.62640.6010	WINDOW REGULATOR	310
63 450 694	81.62640.6011	WINDOW REGULATOR	310
63 450 695	81.62640.6051	WINDOW REGULATOR	310
63 450 696	81.62640.6052	WINDOW REGULATOR	311
63 450 697	81.62641.0001	DOOR HANDLE	235
63 450 698	81.62641.0076	WINDOW CRANK	307
63 450 699	81.62641.0088	DOOR HANDLE	235
63 450 700	81.62641.0089	DOOR HANDLE	235
63 450 701	81.62641.6004	WINDOW CRANK	307
63 450 702	81.62680.6065	DOOR LOCK	237
63 450 703	81.62680.6066	DOOR LOCK	238
63 450 704	81.63731.0183	MIRROR BRACKET	264
63 450 705	81.63731.0197	MIRROR BRACKET	264
63 450 706	81.63731.0228	MIRROR BRACKET	265
63 450 707	81.63731.0260	MIRROR COVER	267
63 450 708	81.63731.0261	MIRROR COVER	267
63 450 709	81.63731.6501	MIRROR BRACKET	265
63 450 710	81.63731.6502	MIRROR BRACKET	265
63 450 711	81.63731.6550	REPAIR KIT	279
63 450 712	81.63731.6566	MIRROR ARM	263

Umschlüsselung / Cross Referenz

AL-HU TECH	MAN	Description	Page
63 450 713	81.63731.6569	MIRROR ARM	263
63 450 714	81.63731.6621	REPAIR KIT	279
63 450 715	81.63731.6622	REPAIR KIT	279
63 450 716	81.74821.0039	GAS SPRING	245
63 450 717	81.95501.6270	BOWDEN CABLE	210
63 450 718	81.95501.6452	BOWDEN CABLE	210
63 450 719	81.95501.6457	BOWDEN CABLE	211
63 450 720	81.95501.6460	BOWDEN CABLE	211
63 450 721	81.95501.6477	BOWDEN CABLE	211
63 450 722	81.96002.0328	BUMPER COVER	215
63 450 723	81.96002.0491	BUMPER COVER	215
63 450 724	81.96420.0156	CORRUGATED HOSE	231
63 450 725	81.97001.5081	GRAB HANDLE	248
63 450 726	81.97001.5082	GRAB HANDLE	248
63 450 727	81.97006.0033	GAS SPRING	245
63 450 728	81.97010.0211	COVER, GEARSHIFT	187
63 450 729	81.97100.6030	LOCK SET	259
63 450 730	81.97100.6031	LOCK SET	259
63 450 731	81.97106.6015	CLAMP LOCK	227
63 450 732	81.97440.0170	HOSE CLAMP	255
63 450 733	81.96210.0605	ENGINE MOUNTING	239
63 450 746	51.27421.0216	SENSOR TEMPERATURE	492
63 450 748	51.27120.7037	ABS SENSOR	92
63 450 756	81.27120.6064	ABS SENSOR	93
63 450 757	81.27120.6065	ABS SENSOR	93
63 450 758	81.27120.6165	ABS SENSOR	93
63 450 759	81.27120.6164	ABS SENSOR	93
63 450 760	81.27120.6169	ABS SENSOR	94
63 450 761	81.27120.6168	ABS SENSOR	94
63 450 762	81.27120.6146	ABS SENSOR	94
63 450 763	81.27120.6147	ABS SENSOR	94
63 450 764	51.27120.7038	SPEED SENDER	139
63 450 765	81.27120.6150	ABS SENSOR	95
63 450 766	81.27120.6151	ABS SENSOR	95
63 450 768	81.27120.6157	ABS SENSOR	95
63 450 776	81.27120.6209	ABS SENSOR	95
63 450 777	81.27120.6210	ABS SENSOR	96
63 450 778	81.27120.6186	ABS SENSOR	96
63 450 779	81.27120.6187	ABS SENSOR	96
63 450 780	81.27120.6189	ABS SENSOR	96
63 450 781	81.27120.6182	ABS SENSOR	97
63 450 782	81.27120.6183	ABS SENSOR	97
63 450 783	81.27120.6184	ABS SENSOR	97
63 450 784	81.27120.6185	ABS SENSOR	97
63 450 795	81.25937.0014	ECAS HEIGHT SENSOR	127
63 450 796	81.25937.0040	ECAS HEIGHT SENSOR	127
63 450 797	51.27421.0132	TEMPERATURE SENDER	499
63 450 810	81.32735.6047	CLUTCH BOOSTER	178
63 450 813	81.43702.6077	SHOCK ABSORBER	59
63 450 814	81.50822.6031	TAPPETS KIT	142
63 450 815	81.95301.6291	BALL JOINT	320
63 450 816	81.43610.6134	CONTAINER VALVE	126
63 450 817	51.06630.0082	FAN CLUTCH	390
63 450 824	81.50211.0027	SPRING RETAINING PIN	142

Umschlüsselung / Cross Referenz

AL-HU TECH	MAN	Description	Page
63 450 835	81.43704.0079	STABILIZER MOUNTING	78
63 450 838	81.97010.6001	SHIFT KNOB	198
63 450 842	81.45503.0055	WHEEL NUT	91
63 450 842	81.45503.0058	WHEEL NUT	91
63 451 004	81.52101.6283	PRESSURE LIMITING VALVE	133
63 451 066	81.43270.6091	BALL JOINT REPAIR KIT	12
63 451 067	81.43270.6119	BALL JOINT REPAIR KIT	13
63 451 113	81.43704.0045	STABILIZER MOUNTING	78
63 451 114	81.43706.0011	RUBBER BUSHING	44
63 451 115	81.50211.0030	PIN	40
63 451 116	81.50610.6220	SLACK ADJUSTER	138
63 451 117	81.50610.6222	SLACK ADJUSTER	138
63 451 118	81.91605.0043	COVER	24
63 451 119	81.96210.0243	RADIATOR MOUNTING	43
63 451 120	81.96210.0121	RUBBER MOUNTING	46
63 451 121	81.96210.0302	ENGINE MOUNTING	28
63 451 122	81.98701.0014	EXHAUST GASKET	367
63 451 123	81.52130.6129	FOOT BRAKE VALVE	129
63 451 123	81.52130.6130	FOOT BRAKE VALVE	129
63 451 124	81.52101.6022	PRESSURE LIMITER VALVE	132
63 451 124	81.52101.6073	PRESSURE LIMITER VALVE	132
63 451 125	81.52130.6104	REPAIR KIT	135
63 451 126	81.54901.0102	AIR COMPRESSOR GASKET	108
63 451 127	81.25228.0014	HOUSING	476
63 451 128	81.25505.0668	TOGGLE SWITCH	506
63 451 129	81.25902.0058	RELAY	486
63 451 130	81.26411.0093	CONNECTING LINK	228
63 451 131	81.26411.0094	CONNECTING LINK	228
63 451 132	81.26411.0095	CONNECTING LINK	229
63 451 135	81.61980.0043	HEATER VALVE	405
63 451 136	81.61967.6015	HEATER VALVE	405
63 451 137	81.32655.6181	SHIFT MECHANISM	198
63 451 138	81.62680.6121	DOOR LOCK	238
63 451 139	81.62680.6122	DOOR LOCK	238
63 451 145	81.50610.6266	SLACK ADJUSTER	138
63 451 152	81.35412.0009	SEAL HOLDER	54
63 451 153	81.25507.0015	REVERSE LIGHT SWITCH	490
63 451 331	06.32499.0058	BALL BEARING	5
63 451 332	06.32499.0108	BALL BEARING	5
63 451 333	51.08901.0096	GASKET	403
63 451 334	51.90020.0298	HEX SCREW	406
63 451 335	51.96301.0108	HOSE	407
63 451 336	81.32670.6259	REPAIR KIT	193
63 451 337	81.41304.0041	SPRING BUSHING	64
63 451 338	81.41304.0042	SPRING BUSHING	64
63 451 339	81.41304.0043	SPRING BUSHING	65
63 451 340	81.41304.0050	SPRING BUSHING	65
63 451 341	81.41401.0055	RUBBER MOUNTING	46
63 451 342	81.41506.6195	RUBBER MOUNTING	47
63 451 343	81.43230.6060	BALL JOINT REPAIR KIT	13
63 451 344	81.43270.6047	BALL JOINT REPAIR KIT	13
63 451 345	81.43271.0029	RUBBER MOUNTING	47
63 451 346	81.43271.0087	RUBBER MOUNTING	47
63 451 347	81.43407.0112	RUBBER MOUNTING	47

Umschlüsselung / Cross Referenz

AL-HU TECH	MAN	Description	Page
63 451 348	81.43704.0025	RUBBER MOUNTING	48
63 451 349	81.43704.0038	RUBBER MOUNTING	48
63 451 350	81.43704.0053	RUBBER MOUNTING	48
63 451 351	81.44204.0012	RUBBER MOUNTING	48
63 451 352	81.50211.0018	BRAKE SHOE SPRING PIN	123
63 451 353	81.62158.5021	HOLDER	254
63 451 354	81.62900.6179	GAS SPRING	246
63 451 355	81.74821.0041	GAS SPRING	246
63 451 356	81.74821.0063	GAS SPRING	246
63 451 357	81.74821.0068	GAS SPRING	246
63 451 358	81.74821.0104	GAS SPRING	247
63 451 359	81.74821.0107	GAS SPRING	247
63 451 360	81.74821.0110	GAS SPRING	247
63 451 361	81.74821.0131	GAS SPRING	247
63 451 362	81.74821.0140	GAS SPRING	248
63 451 363	81.90490.0696	SCREW	53
63 451 364	81.93020.2315	BUSHING	17
63 451 365	81.95301.0048	BALL SOCKET	13
63 451 366	81.95310.0015	SEAL	53
63 451 367	81.96020.0286	STABILIZER MOUNTING	78
63 451 368	81.96210.0100	RUBBER MOUNTING	49
63 451 369	81.96210.0130	RUBBER MOUNTING	49
63 451 370	81.96210.0132	RUBBER MOUNTING	49
63 451 371	81.96210.0278	RUBBER MOUNTING	49
63 451 372	81.96210.0289	RUBBER MOUNTING	50
63 451 373	81.96210.0294	RUBBER MOUNTING	50
63 451 374	81.96210.0348	RUBBER MOUNTING	50
63 451 375	81.96210.0353	RUBBER MOUNTING	50
63 451 376	81.96210.0402	RUBBER MOUNTING	51
63 451 377	81.96210.5011	RUBBER MOUNTING	51
63 451 378	81.96301.0321	TURBO HOSE	453
63 451 379	81.96301.0323	TURBO HOSE	453
63 451 380	81.96301.0458	TURBO HOSE	453
63 451 381	81.96420.0207	BELLOWS SEAL	118
63 451 382	81.97420.5045	EXHAUST CLAMP	366
63 451 383	81.97460.6021	EXHAUST CLAMP	367
63 451 384	81.97610.0224	SPRING	141
63 451 385	81.97610.0271	SPRING	141
63 451 386	81.97610.6013	SPRING	141
63 451 387	85.43704.0002	RUBBER MOUNTING	51
63 451 388	85.43722.0007	RUBBER MOUNTING	51
63 451 389	85.43722.0010	RUBBER MOUNTING	52
63 451 390	85.43722.0011	RUBBER MOUNTING	52
63 451 391	85.96210.0008	RUBBER MOUNTING	52
63 451 392	85.96210.0020	RUBBER MOUNTING	52
63 451 393	85.96501.0002	GASKET	29
63 451 395	82.43701.6017	SHOCK ABSORBER	59
63 451 402	81.32655.6249	BOWDEN CABLE	211
63 451 483	81.25521.6017	PRESSURE SWITCH	483
63 451 485	81.25520.0043	PRESSURE SWITCH	484
63 451 510	81.32620.0091	SHIFT KNOB	198
63 451 653	81.26109.0014	RECTIFIER	165
63 451 654	81.26401.6087	WIPER MOTOR	317
63 451 661	85.96210.0025	SPRING MOUNTING	67

Umschlüsselung / Cross Referenz

AL-HU TECH	MAN	Description	Page
63 451 662	51.12150.0002	FUEL PUMP	402
63 451 663	51.27421.0213	HEAT SENSOR	475
63 451 664	81.30560.0078	RELEASE LEVER	192
63 451 665	81.30530.0037	CLUTCH FORK	179
63 451 666	81.08903.0109	SEAL RING	441
63 451 667	81.08340.0145	SPRING, AIR FILTER	442
63 451 679	81.50202.0108	BRAKE ANCHOR PLATE	118
63 453 007	81.43701.6584	SHOCK ABSORBER	59
63 453 008	85.41722.6017	CABIN DAMPER	220
63 453 009	81.43701.6904	SHOCK ABSORBER	60
63 453 010	51.26201.7231	STARTER MOTOR	170
63 453 015	81.95501.6451	BOWDEN CABLE	343
63 453 016	51.03101.6510	CYLINDER HEAD	355
63 453 018	81.52102.6103	AIR DRYER	115
63 453 018	81.52102.6104	AIR DRYER	115
63 453 023	81.96210.0439	ENGINE MOUNTING	363
63 453 024	51.27421.0165	HEAT SENSOR	475
63 453 025	81.41685.0029	BUMPER COVER	216
63 453 042	81.26109.0018	RECTIFIER ASSY	166
63 453 043	81.06630.6038	FAN CLUTCH	390
63 453 047	81.96210.0184	RUBBER MOUNTING	53
63 453 048	81.96210.0023	ENGINE MOUNTING	28
63 453 049	81.50610.6221	SLACK ADJUSTER	138
63 453 050	81.96210.0238	ENGINE MOUNTING	29
63 453 051	81.25520.6007	BRAKE LIGHT SWITCH	469
63 453 052	51.90490.0079	CONROD SCREW	350
63 453 054	81.43402.6217	PARABOLIC SPRING	39
63 453 054	81.43402.6224	PARABOLIC SPRING	39
63 453 055	81.43402.6300	PARABOLIC SPRING	39
63 453 055	81.43402.6320	PARABOLIC SPRING	39
63 453 056	81.43270.6097	CONTROL ARM	321
66 220 002	06.08042.0604	DRAIN PLUG	145
66 220 006	06.01494.6526	HEX SHOULDER STUD	151
66 220 007	06.01013.7221	HEX SHOULDER STUD M10X80 8.8	151
70.583.050	81.25505.0462	CHANGE-OVER SWITCH	471
73 240 001	06.46110.2135	U-BOLT	85
73 240 002	06.46112.0205	U-BOLT	86
73 240 003	06.46115.0460	U-BOLT	86
73 240 004	06.46119.0021	U-BOLT	86
73 240 005	06.46113.3360	U-BOLT	86
8.8M12X1.5X30	06.02099.0204	CHEESE HEAD SCREW DIN 912	144

Umschlüsselung OEM / Cross Reference OEM

MAN	AL-HU TECH	Description	Page
A5.00024.0938	21 014 052	CARBON BRUSH SET	160
N1.01101.0080	24 051 176	CLUTCH BOOSTER	177
N1.01106.6148	22 400 006	4-CIRCUIT PROTECTION VALVE	143
04.27405.9160	28 600 024	RADIATOR HOSE	434
04.27405.9502	28 405 502	RADIATOR HOSE	434
04.27405.9550	63 450 162	RADIATOR HOSE	435
04.27405.9860	28 405 860	RADIATOR HOSE	434
06.01013.7221	66 220 007	HEX SHOULDER STUD M10X80 8.8	151
06.01493.4719	23 000 004	HEX SHOULDER STUD	150
06.01493.4725	23 000 012	HEX SHOULDER STUD	151
06.01493.4730	23 000 006	HEX SHOULDER SCREW	148
06.01493.4733	23 000 011	HEX SHOULDER STUD	150
06.01493.4740	23 000 010	HEX SHOULDER SCREW	149
06.01493.4925	23 000 013	HEX SHOULDER SCREW	149
06.01493.4932	63 450 594	HEX SHOULDER STUD DIN 960	151
06.01494.4718	23 000 009	HEX SHOULDER SCREW	149
06.01494.4734	23 000 003	HEX SHOULDER SCREW	148
06.01494.4935	20 000 935	HEX SHOULDER STUD	150
06.01494.6511	20 000 936	HEX SHOULDER STUD 10.9	152
06.01494.6526	66 220 006	HEX SHOULDER STUD	151
06.01494.6724	23 000 005	HEX SHOULDER SCREW	148
06.01494.6933	20 000 933	HEX SHOULDER STUD	150
06.01494.7317	63 450 323	HEX SHOULDER STUD	30
06.01499.0173	23 000 008	HEX SHOULDER SCREW	149
06.01733.4921	23 000 014	HEX BOLT	147
06.02099.0204	8.8M12X1.5X30	CHEESE HEAD SCREW DIN 912	144
06.02099.0351	M10X45	CYLINDER SCREW	145
06.02191.2923	23 000 007	CYLINDER SCREW	145
06.02202.1013	23 000 002	HEX COLLAR BOLT	147
06.02202.4212	63 450 593	HEX COLLAR BOLT	147
06.02813.4912	20 000 912	HEX LOCK SCREW	148
06.02813.4915	20 000 915	TENSILOCK SCREW	155
06.02813.4916	20 000 916	TENSILOCK SCREW	155
06.02813.4919	20 000 919	TENSILOCK SCREW	156
06.02813.5013	20 000 013	TENSILOCK SCREW	153
06.02815.8812	20 000 812	TENSILOCK SCREW	154
06.02815.8911	20 000 911	TENSILOCK SCREW	154
06.02815.8913	20 000 913	TENSILOCK SCREW	155
06.02815.8914	20 000 914	TENSILOCK SCREW	155
06.02815.8917	20 000 917	TENSILOCK SCREW	156
06.02815.9015	20 000 015	TENSILOCK SCREW	153
06.02815.9017	20 000 017	TENSILOCK SCREW	154
06.02815.9022	20 000 022	TENSILOCK SCREW	154
06.02816.1413	63 450 592	LOCK SCREW	153
06.02819.0005	63 450 591	LOCK SCREW	152
06.08042.0603	M14X1.5	DRAIN PLUG	145
06.08042.0604	66 220 002	DRAIN PLUG	145
06.08049.0004	63 450 590	DRAIN PLUG	357
06.08049.0028	G 1/2 A	DRAIN PLUG DIN 908	146
06.09019.0032	21 002 000	SPRING BOLT	60
06.09019.0049	21 002 001	SPRING BOLT	61
06.09019.0063	21 002 002	SPRING BOLT	61
06.09019.0095	21 002 003	SPRING BOLT	61
06.11065.2317	M14X1.5	HEXAGON NUT DIN 934	152

Umschlüsselung OEM / Cross Reference OEM

MAN	AL-HU TECH	Description	Page
06.11241.0317	AM 16X1.5	HEX LOCK NUT	147
06.11251.2005	20 001 005	FLAT COLLAR NUT	146
06.11251.8108	20 001 108	FLAT COLLAR NUT	146
06.21569.0066	63 450 119	CLEVIS PIN	144
06.21569.0077	63 450 128	CLEVIS PIN	144
06.32489.0041	21 981 001	BALL BEARING	4
06.32489.0051	21 401 019	BALL BEARING	4
06.32499.0058	63 451 331	BALL BEARING	5
06.32499.0108	63 451 332	BALL BEARING	5
06.33719.0057	63 450 150	NEEDLE SLEEVE	38
06.36064.0164	22 420 001	YOKE	143
06.36099.0002	63 450 589	BALL SOCKET	336
06.36950.0210	28 500 210	BEARING BUSH	205
06.36950.0508	63 450 193	BEARING BUSH	14
06.36950.0510	28 618 510	JOINT BEARING	327
06.36959.0014	24 420 014	BEARING BUSH	14
06.36959.0027	21 000 009	BEARING BUSH	14
06.43809.0176	63 450 588	LOCKING PIN	153
06.46110.2135	73 240 001	U-BOLT	85
06.46112.0205	73 240 002	U-BOLT	86
06.46113.0370	21 001 002	U-BOLT	85
06.46113.2510	21 001 003	U-BOLT	85
06.46113.3360	73 240 005	U-BOLT	86
06.46115.0460	73 240 003	U-BOLT	86
06.46119.0003	21 001 005	U-BOLT	85
06.46119.0021	73 240 004	U-BOLT	86
06.54059.0007	63 450 587	HOSE PIPE	408
06.54059.0012	63 450 092	HOSE PIPE	131
06.54099.0121	21 203 010	HOSE PIPE	255
06.54099.0124	21 203 009	HOSE PIPE	130
06.54100.4370	21 203 012	CLUTCH HOSE	179
06.67042.0113	24 997 113	EXHAUST CLAMP	366
06.67042.0116	24 997 099	EXHAUST CLAMP	365
06.67049.0005	24 997 005	EXHAUST CLAMP	364
06.67049.0099	24 997 099	EXHAUST CLAMP	365
06.67124.1024	63 450 586	HOSE CLAMP	407
09.11003.0427	CHF11S	HYDRAULIC OIL 1 LITRE TIN	152
36.97116.0000	63 450 215	SNAP LOCK	288
51.01304.6062	28 000 008	TIMING CASE	447
51.01305.5102	28 000 009	TIMING COVER	447
51.01401.6049	21 010 233	TIMING CASE	447
51.01601.5065	28 000 010	OIL SPRAYER NOZZLE	425
51.01601.5066	21 017 066	OIL SPRAYER NOZZLE	424
51.01601.5081	21 017 081	OIL SPRAYER NOZZLE	424
51.01601.5082	21 017 067	OIL SPRAYER NOZZLE	424
51.01601.5083	21 017 083	OIL SPRAYER NOZZLE	424
51.01804.0008	28 804 008	PRESSURE REGULATING VALVE	426
51.01804.7023	21 018 235	OIL SEPERATOR	423
51.01804.7026	21 018 435	OIL SEPERATOR	423
51.01804.7028	21 018 035	OIL SEPERATOR	423
51.01804.7032	21 018 935	OIL SEPARATOR	422
51.01804.7037	21 018 135	OIL SEPERATOR	423
51.01901.0129	63 450 595	TIMING CASE GASKET	447
51.02100.6019	21 030 019	CRANKSHAFT	352

Umschlüsselung OEM / Cross Reference OEM

MAN	AL-HU TECH	Description	Page
51.02100.6025	21 030 301	CRANKSHAFT	352
51.02101.6088	21 030 201	CRANKSHAFT	352
51.02101.6090	21 030 501	CRANKSHAFT	353
51.02101.6097	21 030 401	CRANKSHAFT	353
51.02115.0182	21 030 182	TIMING GEAR - CRANKSHAFT	448
51.02115.6076	28 115 076	TIMING GEAR	448
51.02130.0013	21 032 309	CRANKSHAFT RACE	353
51.02130.0032	21 031 127	CRANKSHAFT RACE	353
51.02201.0064	21 030 064	VIBRATION DAMPER	456
51.02201.0081	63 450 596	VIBRATION DAMPER	456
51.02201.0091	63 450 597	VIBRATION DAMPER	457
51.02201.0099	28 000 011	VIBRATION DAMPER	456
51.02301.5109	28 030 013	FLYWHEEL	395
51.02301.5121	21 030 321	FLYWHEEL	393
51.02301.5167	28 030 021	FLYWHEEL	396
51.02301.5258	21 030 258	FLYWHEEL	393
51.02301.5259	28 030 259	FLYWHEEL	396
51.02301.6033	28 030 011	FLYWHEEL	395
51.02301.6034	21 030 034	FLYWHEEL	392
51.02301.6043	21 030 043	FLYWHEEL	392
51.02301.6044	28 030 015	FLYWHEEL	396
51.02301.6050	28 030 014	FLYWHEEL	395
51.02301.7295	21 030 402	FLYWHEEL	393
51.02301.7300	21 030 403	FLYWHEEL	393
51.02301.7389	28 030 010	FLYWHEEL	395
51.02301.7410	21 030 441	FLYWHEEL	394
51.02301.7439	21 030 439	FLYWHEEL	394
51.02301.7440	28 030 009	FLYWHEEL	394
51.02310.0086	21 030 086	FLYWHEEL RING GEAR	396
51.02310.0087	21 030 087	FLYWHEEL RING GEAR	397
51.02310.0097	21 030 097	FLYWHEEL RING GEAR	397
51.02400.6015	21 031 420	CONROD	349
51.02400.6023	21 031 120	CONROD	349
51.02400.6044	21 031 020	CONROD	349
51.02400.6049	21 030 221	CONROD	348
51.02400.6054	21 030 421	CONROD	348
51.02400.6066	21 030 621	CONROD	349
51.02401.6214	21 030 120	CONROD	348
51.02401.6234	21 030 520	CONROD	348
51.02601.0473	28 601 473	V-BELT PULLEY	457
51.02601.0506	28 601 506	V-BELT PULLEY	457
51.03100.6053	21 010 020	CYLINDER HEAD	354
51.03100.6181	21 010 181	CYLINDER HEAD	354
51.03101.6510	63 453 016	CYLINDER HEAD	355
51.03101.6682	21 010 682	CYLINDER HEAD	355
51.03101.6773	21 010 120	CYLINDER HEAD	354
51.03101.6774	21 010 220	CYLINDER HEAD	354
51.03201.0088	06.3.02536	VALVE GUIDE	453
51.03201.0102	06.3.25102	VALVE GUIDE	454
51.03203.0163	22 260 163	VALVE SEAT RING	454
51.03203.0168	22 260 168	VALVE SEAT RING	454
51.03203.0171	22 260 171	VALVE SEAT RING	454
51.03203.0184	22 260 184	VALVE SEAT RING	455
51.03203.0242	22 260 242	VALVE SEAT RING	455

Umschlüsselung OEM / Cross Reference OEM

MAN	AL-HU TECH	Description	Page
51.03203.0293	22 260 293	VALVE SEAT RING	455
51.04202.5034	21 050 236	ROCKER ARM BRACKET	440
51.04203.5058	63 450 250	ROCKER SHAFT	440
51.04301.0007	21 054 001	VALVE TAPPET	456
51.04301.0109	21 050 025	VALVE TAPPET	455
51.04302.0066	21 054 005	PUSH ROD	427
51.04400.6006	21 030 101	CAMSHAFT	344
51.04401.5053	21 030 001	CAMSHAFT	343
51.04401.6148	21 050 004	CAMSHAFT	345
51.04401.6266	21 050 101	CAMSHAFT	345
51.04401.6290	21 050 001	CAMSHAFT	344
51.04401.6371	21 050 011	CAMSHAFT	345
51.04401.6373	21 050 002	CAMSHAFT	344
51.04401.6375	21 050 003	CAMSHAFT	344
51.04401.6382	21 050 211	CAMSHAFT	346
51.04401.6398	21 050 111	CAMSHAFT	345
51.04501.0144	63 450 598	CAMSHAFT GEAR	346
51.04505.0108	63 450 599	CAMSHAFT GEAR	346
51.04505.5061	63 450 600	CAMSHAFT GEAR	346
51.05100.6133	21 180 701	OIL PUMP	422
51.05100.6135	21 180 801	OIL PUMP	422
51.05100.6279	21 180 501	OIL PUMP	421
51.05201.0073	63 450 601	OIL PUMP GEAR	422
51.05405.0012	28 000 014	OIL PRESSURE VALVE	421
51.05405.5024	21 180 115	OIL PRESSURE VALVE	420
51.05405.7017	28 000 012	OIL PRESSURE VALVE	421
51.05405.7044	28 000 013	OIL PRESSURE VALVE	421
51.05503.6006	21 180 438	OIL FILTER HEAD	418
51.05503.6093	63 450 603	OIL FILTER HEAD	419
51.05503.6094	28 503 094	OIL FILTER HEAD	418
51.05503.6096	28 000 001	OIL FILTER HEAD	418
51.05503.6105	63 450 602	OIL FILTER HEAD	419
51.05503.6106	63 450 604	OIL FILTER HEAD	419
51.05505.0011	28 505 011	COVER, OIL FILTER	352
51.05505.6002	21 184 002	COVER	351
51.05601.0121	21 188 001	OIL COOLER	414
51.05601.0148	63 450 070	OIL COOLER	415
51.05805.5304	63 450 605	OIL DIPSTICK	416
51.05805.5335	21 010 172	OIL DIPSTICK	415
51.05805.5414	21 010 414	OIL DIPSTICK	415
51.05805.5558	63 450 606	OIL DIPSTICK	416
51.05805.5578	63 450 607	OIL DIPSTICK	416
51.05805.5608	63 450 608	OIL DIPSTICK	417
51.05805.5609	21 010 472	OIL DIPSTICK	416
51.05805.5695	63 450 609	OIL DIPSTICK	417
51.05805.5744	63 450 610	OIL DIPSTICK	417
51.05904.0195	21 904 195	GASKET	402
51.05904.0197	63 450 611	OIL PAN GASKET	420
51.05904.0198	28 000 002	OIL PAN GASKET	420
51.05904.0212	21 904 212	OIL PAN GASKET	420
51.06301.0854	63 450 612	THERMOSTAT COVER	445
51.06301.0950	63 450 613	COOLING WATER PIPE	351
51.06301.5680	21 203 680	COOLING WATER PIPE	351
51.06301.5725	63 450 614	COOLANT ELBOW	350

Umschlüsselung OEM / Cross Reference OEM

MAN	AL-HU TECH	Description	Page
51.06302.0259	63 450 615	COOLANT ELBOW	350
51.06302.5115	21 203 115	COOLING WATER LINE	351
51.06302.5524	21 203 524	BREATHER TUBE	343
51.06303.5351	21 203 008	COOLING WATER LINE	350
51.06402.0060	21 204 083	THERMOSTAT 83 DEGREES	446
51.06402.0061	21 204 079	THERMOSTAT 79 DEGREES	446
51.06402.0063	21 204 083	THERMOSTAT 83 DEGREES	446
51.06402.0065	21 204 071	THERMOSTAT 71 DEGREES	446
51.06404.0067	21 200 045	THERMOSTAT HOUSING	445
51.06405.0021	21 200 021	THERMOSTAT COVER	445
51.06500.6228	21 200 036	WATER PUMP	462
51.06500.6426	21 200 601	WATER PUMP	465
51.06500.6472	21 200 087	WATER PUMP	462
51.06500.6476	21 200 111	WATER PUMP	463
51.06500.6479	21 200 501	WATER PUMP	464
51.06500.6480	21 200 904	WATER PUMP	466
51.06500.6492	21 200 301	WATER PUMP	464
51.06500.6495	21 200 011	WATER PUMP	462
51.06500.6515	21 200 515	WATER PUMP	464
51.06500.6537	21 200 101	WATER PUMP	463
51.06500.6543	21 200 905	WATER PUMP	466
51.06500.6546	21 200 801	WATER PUMP	465
51.06500.6547	21 200 547	WATER PUMP	464
51.06500.6548	21 200 903	WATER PUMP	466
51.06500.6569	21 200 905	WATER PUMP	466
51.06500.6606	21 200 701	WATER PUMP	465
51.06500.6612	21 200 701	WATER PUMP	465
51.06500.6646	21 200 086	WATER PUMP	462
51.06500.6669	21 200 701	WATER PUMP	465
51.06500.6676	21 200 086	WATER PUMP	462
51.06500.6679	21 200 105	WATER PUMP	463
51.06500.6680	21 200 100	WATER PUMP	463
51.06500.7049	21 200 676	WATER PUMP	465
51.06500.7066	21 200 966	WATER PUMP	466
51.06500.7089	21 200 966	WATER PUMP	466
51.06500.9049	21 200 676	WATER PUMP	465
51.06500.9066	21 200 966	WATER PUMP	466
51.06500.9492	21 200 301	WATER PUMP	464
51.06500.9537	21 200 101	WATER PUMP	463
51.06500.9546	21 200 801	WATER PUMP	465
51.06500.9612	21 200 701	WATER PUMP	465
51.06500.9679	21 200 105	WATER PUMP	463
51.06500.9680	21 200 100	WATER PUMP	463
51.06503.0122	21 200 079	V-BELT PULLEY	458
51.06503.0123	21 200 080	V-BELT PULLEY	458
51.06503.0237	21 200 237	V-BELT PULLEY	458
51.06503.0279	21 205 279	V-BELT PULLEY	459
51.06503.0325	21 200 325	V-BELT PULLEY	458
51.06599.6033	21 999 002	WATER PUMP KIT	467
51.06599.6052	21 999 003	WATER PUMP KIT	467
51.06600.6093	28 600 093	FAN BEARING	379
51.06600.7015	21 200 096	FAN CLUTCH	388
51.06600.7033	21 200 026	FAN CLUTCH	384
51.06600.7045	21 200 096	FAN CLUTCH	388

Umschlüsselung OEM / Cross Reference OEM

MAN	AL-HU TECH	Description	Page
51.06600.7046	21 200 095	FAN CLUTCH	387
51.06601.0102	21 205 102	FAN BLADE	381
51.06601.0107	21 205 107	FAN BLADE	382
51.06601.0172	21 205 172	FAN BLADE	382
51.06601.0178	21 205 004	FAN BLADE	381
51.06601.0200	21 205 200	FAN BLADE	382
51.06601.0227	21 200 092	FAN CLUTCH	387
51.06601.0230	21 205 230	FAN BLADE	382
51.06601.0233	21 200 032	FAN BLADE	380
51.06601.0243	21 200 006	FAN CLUTCH	384
51.06601.0250	21 200 028	FAN BLADE	379
51.06601.0256	21 205 256	FAN BLADE	383
51.06601.0257	21 205 257	FAN BLADE	383
51.06601.0258	21 200 258	FAN BLADE	380
51.06601.0261	63 450 118	FAN BLADE	384
51.06601.0263	21 205 002	FAN BLADE	380
51.06601.0264	21 205 003	FAN BLADE	381
51.06601.0265	21 205 265	FAN BLADE	383
51.06601.0266	21 205 005	FAN BLADE	381
51.06601.0268	21 200 268	FAN BLADE	380
51.06601.0275	21 205 275	FAN BLADE	383
51.06601.0279	21 200 027	FAN BLADE	379
51.06604.0061	21 200 005	FAN CLUTCH ADAPTOR	390
51.06606.0062	63 450 616	V-BELT PULLEY	461
51.06606.0075	28 105 075	V-BELT PULLEY	459
51.06606.0097	63 450 617	V-BELT PULLEY	461
51.06608.0030	26 608 030	FAN SHROUD	240
51.06630.0037	21 200 037	FAN CLUTCH	385
51.06630.0043	21 200 037	FAN CLUTCH	385
51.06630.0047	21 201 047	FAN CLUTCH	389
51.06630.0060	21 200 060	FAN CLUTCH	385
51.06630.0066	21 200 066	FAN CLUTCH	385
51.06630.0067	21 200 067	FAN CLUTCH	385
51.06630.0068	21 200 068	FAN CLUTCH	386
51.06630.0071	21 200 093	FAN CLUTCH	387
51.06630.0072	21 200 072	FAN CLUTCH	386
51.06630.0074	21 200 074	FAN CLUTCH	386
51.06630.0077	21 200 077	FAN CLUTCH	386
51.06630.0082	63 450 817	FAN CLUTCH	390
51.06630.0112	21 200 112	FAN CLUTCH	388
51.06630.0115	21 200 115	FAN CLUTCH	388
51.06630.0119	21 200 094	FAN CLUTCH	387
51.06630.0129	21 200 129	FAN CLUTCH	389
51.06630.0130	21 200 130	FAN CLUTCH	389
51.06630.0131	21 200 107	FAN CLUTCH	388
51.06630.7022	28 663 022	SUPPORTING ARM	443
51.06650.0005	63 450 252	DRIVE SHAFT	358
51.06903.0030	63 450 618	WATER PIPE GASKET	461
51.08101.0609	63 450 619	EXHAUST MANIFOLD	370
51.08101.0610	63 450 620	EXHAUST MANIFOLD	370
51.08101.0630	63 450 621	EXHAUST MANIFOLD	370
51.08101.0631	63 450 622	EXHAUST MANIFOLD	370
51.08101.0683	63 450 623	EXHAUST MANIFOLD	371
51.08101.0704	63 450 624	EXHAUST MANIFOLD	371

Umschlüsselung OEM / Cross Reference OEM

MAN	AL-HU TECH	Description	Page
51.08101.0909	26 810 909	EXHAUST MANIFOLD	368
51.08101.0910	26 810 910	EXHAUST MANIFOLD	368
51.08101.0911	26 810 911	EXHAUST MANIFOLD	368
51.08101.0912	26 810 912	EXHAUST MANIFOLD	368
51.08101.0913	26 810 913	EXHAUST MANIFOLD	369
51.08101.0914	26 810 915	EXHAUST MANIFOLD	369
51.08102.0024	26 810 916	EXHAUST MANIFOLD	369
51.08102.0077	28 102 077	EXHAUST MANIFOLD	369
51.08301.0016	21 470 007	AIR CLEANER	334
51.08901.0096	63 451 333	GASKET	403
51.08901.0200	63 450 625	EXHAUST MANIFOLD GASKET	372
51.08902.0179	63 450 626	INLET MANIFOLD GASKET	412
51.09402.0030	63 450 627	TURBO HOSE	452
51.09402.0118	21 098 118	BELLOW	336
51.09402.0188	21 098 188	BELLOW	336
51.09901.0036	63 450 628	TURBO GASKET	448
51.10108.0003	21 017 003	PRESSURE SCREW	426
51.10108.0005	21 074 005	PRESSURE SCREW	426
51.10300.6023	21 203 003	INJECTION LINE SET	409
51.10300.6029	21 203 022	INJECTION LINE	408
51.10300.6032	21 203 013	INJECTION LINE SET	409
51.10301.6176	21 203 019	INJECTION LINE SET	410
51.10301.6177	21 203 020	INJECTION LINE SET	410
51.10302.6025	21 203 026	COMPRESSOR HOSE	347
51.10303.6025	21 203 018	INJECTION LINE SET	410
51.10303.6107	63 450 629	INJECTION LINE SET	411
51.10303.6115	21 203 002	INJECTION LINE SET	408
51.10303.6144	21 203 017	INJECTION LINE SET	409
51.10303.6159	21 203 021	INJECTION LINE SET	410
51.10303.6177	21 203 001	INJECTION LINE SET	408
51.10303.6191	21 203 016	INJECTION LINE SET	409
51.10303.6220	21 203 031	INJECTION LINE SET	411
51.10303.6236	63 450 630	INJECTION LINE SET	411
51.11160.6009	21 070 009	BOOSTER CYLINDER	341
51.11301.0090	63 450 631	DRIVE GEAR	357
51.11301.0159	63 450 632	DRIVE GEAR	358
51.11401.0142	28 000 142	MOUNTING FLANGE	413
51.12101.7019	21 440 040	FUEL FEED PUMP	398
51.12101.7034	21 440 177	FUEL FEED PUMP	400
51.12101.7035	21 440 183	FUEL FEED PUMP	400
51.12101.7038	21 040 003	FUEL FEED PUMP	397
51.12101.7039	21 440 245	FUEL FEED PUMP	400
51.12101.7040	21 440 998	FUEL FEED PUMP	400
51.12101.7046	28 000 007	FUEL PUMP	402
51.12101.7047	28 000 006	FUEL PUMP	402
51.12101.7099	21 440 171	FUEL FEED PUMP	399
51.12101.7101	21 440 002	FUEL FEED PUMP	397
51.12101.7102	21 440 174	FUEL FEED PUMP	399
51.12101.7106	21 440 084	FUEL FEED PUMP	398
51.12101.7107	21 440 092	FUEL FEED PUMP	399
51.12101.7121	21 440 089	FUEL FEED PUMP	399
51.12101.7136	28 000 006	FUEL PUMP	402
51.12101.7137	28 000 007	FUEL PUMP	402
51.12150.0002	63 451 662	FUEL PUMP	402

Umschlüsselung OEM / Cross Reference OEM

MAN	AL-HU TECH	Description	Page
51.12150.7002	21 447 000	HAND PUMP	404
51.12150.7022	21 440 007	FUEL FEED PUMP	398
51.12501.7115	21 090 115	FUEL FILTER 2 STAGES	401
51.12503.0050	21 090 751	REPAIR KIT	439
51.12503.0062	21 090 751	REPAIR KIT	439
51.12503.6000	21 470 004	WATER SEPARATOR FILTER	467
51.12504.0008	63 450 633	FILTER HEAD	390
51.12504.6003	63 450 634	FILTER HEAD	391
51.12504.6004	63 450 635	FILTER HEAD	391
51.12505.0004	21 074 515	OVERFLOW VALVE	425
51.15201.6183	63 450 636	EXHAUST ELBOW	367
51.15901.0012	63 450 637	EXHAUST GASKET	367
51.19107.0064	28 107 064	GUIDE PIECE, TENSIONER	403
51.25601.0006	21 144 122	VOLTAGE REGULATOR	172
51.26101.7148	21 489 728	ALTERNATOR	158
51.26101.7192	21 468 053	ALTERNATOR	157
51.26101.7201	21 469 982	ALTERNATOR	157
51.26101.7215	21 488 291	ALTERNATOR	157
51.26101.7265	21 525 501	ALTERNATOR	158
51.26101.7266	21 325 500	ALTERNATOR	157
51.26101.7268	21 655 011	ALTERNATOR	159
51.26101.7269	21 555 014	ALTERNATOR	158
51.26101.7270	21 655 009	ALTERNATOR	159
51.26101.7271	21 555 013	ALTERNATOR	158
51.26101.9265	21 525 501	ALTERNATOR	158
51.26101.9266	21 325 500	ALTERNATOR	157
51.26101.9269	21 555 014	ALTERNATOR	158
51.26101.9270	21 655 009	ALTERNATOR	159
51.26101.9271	21 555 013	ALTERNATOR	158
51.26105.0185	28 105 185	V-BELT PULLEY	459
51.26105.0247	63 450 237	V-BELT PULLEY	460
51.26105.0248	28 105 248	V-BELT PULLEY	459
51.26105.0301	63 450 644	V-BELT PULLEY	461
51.26201.7074	21 416 024	STARTER MOTOR	170
51.26201.7112	21 416 022	STARTER MOTOR	169
51.26201.7123	21 417 001	STARTER MOTOR	170
51.26201.7159	21 431 002	STARTER MOTOR	170
51.26201.7213	21 231 030	STARTER MOTOR	169
51.26201.7231	63 453 010	STARTER MOTOR	170
51.26201.9213	21 231 030	STARTER MOTOR	169
51.27120.0008	21 271 008	SPEED SENSOR	139
51.27120.0009	21 271 009	SPEED SENSOR	140
51.27120.0014	21 271 014	SPEED SENSOR	140
51.27120.0015	21 271 015	SPEED SENSOR	140
51.27120.7037	63 450 748	ABS SENSOR	92
51.27120.7038	63 450 764	SPEED SENDER	139
51.27420.0008	21 542 917	TEMPERATURE SENSOR	499
51.27420.7005	63 450 214	TEMPERATURE SENDER	499
51.27421.0113	29 421 113	TEMPERATURE SENSOR	500
51.27421.0132	63 450 797	TEMPERATURE SENDER	499
51.27421.0151	29 255 151	TEMPERATURE SENDER	498
51.27421.0165	63 453 024	HEAT SENSOR	475
51.27421.0190	28 421 190	TEMPERATURE SENSOR	499
51.27421.0213	63 451 663	HEAT SENSOR	475

Umschlüsselung OEM / Cross Reference OEM

MAN	AL-HU TECH	Description	Page
51.27421.0216	63 450 746	SENSOR TEMPERATURE	492
51.47104.0024	28 471 024	DRIVING DOG	358
51.54000.7058	21 130 058	AIR COMPRESSOR	99
51.54000.7063	21 130 063	AIR COMPRESSOR	100
51.54000.7079	21 130 079	AIR COMPRESSOR	100
51.54000.7112	21 130 047	AIR COMPRESSOR	99
51.54000.7128	21 130 065	AIR COMPRESSOR	100
51.54000.7129	21 130 129	AIR COMPRESSOR	101
51.54100.6001	21 130 009	AIR COMPRESSOR	98
51.54100.6007	21 130 007	AIR COMPRESSOR	98
51.54100.6015	21 130 015	AIR COMPRESSOR	99
51.54100.6042	21 131 042	AIR COMPRESSOR REPAIR KIT	113
51.54100.6049	21 130 049	AIR COMPRESSOR REPAIR KIT	113
51.54100.7003	21 130 003	AIR COMPRESSOR	98
51.54100.7121	21 130 121	AIR COMPRESSOR	100
51.54100.9007	21 130 007	AIR COMPRESSOR	98
51.54101.7247	21 130 016	AIR COMPRESSOR	99
51.54103.0001	21 131 001	AIR COMPRESSOR PISTON RING	111
51.54103.0002	21 130 027	AIR COMPRESSOR PISTON RING	111
51.54105.6006	21 130 008	AIR COMPRESSOR PISTON ASSEMBLY	111
51.54105.6008	21 130 608	AIR COMPRESSOR PISTON ASSEMBLY	111
51.54105.6021	21 130 021	AIR COMPRESSOR CYLINDER HEAD	105
51.54106.6013	21 130 816	AIR COMPRESSOR CONROD	102
51.54106.6021	24 130 916	AIR COMPRESSOR CONROD	102
51.54112.6008	24 130 010	AIR COMPRESSOR HOUSING	110
51.54112.6020	21 130 110	AIR COMPRESSOR HOUSING	110
51.54112.6030	21 130 030	AIR COMPRESSOR HOUSING	109
51.54113.0017	21 131 016	AIR COMPRESSOR CRANKSHAFT	103
51.54113.5027	21 131 116	AIR COMPRESSOR CRANKSHAFT	104
51.54113.5044	21 130 044	AIR COMPRESSOR CRANKSHAFT	103
51.54114.6054	21 130 019	AIR COMPRESSOR CYLINDER HEAD	105
51.54114.6073	21 130 073	AIR COMPRESSOR CYLINDER HEAD	105
51.54114.6081	21 130 081	AIR COMPRESSOR CYLINDER HEAD	105
51.54114.6084	21 130 084	AIR COMPRESSOR CYLINDER HEAD	106
51.54116.0002	21 130 002	AIR COMPRESSOR SUCTION DISC	114
51.54119.6001	21 132 002	AIR COMPRESSOR PISTON	110
51.54119.6009	21 132 009	AIR COMPRESSOR PISTON RING	112
51.54122.0007	63 450 244	RELIEF VALVE	135
51.54124.6003	21 130 011	AIR COMPRESSOR REPAIR KIT	112
51.54124.6004	21 130 005	AIR COMPRESSOR LAMELLA	110
51.54130.6011	21 130 045	AIR COMPRESSOR FLANGE	106
51.54130.6021	21 131 021	AIR COMPRESSOR BEARING FLANGE	101
51.54201.0112	63 450 256	V-BELT PULLEY	460
51.54206.0004	63 450 242	FOLLOWER	128
51.54210.0038	21 130 024	AIR COMPRESSOR GEAR	109
51.54210.0108	21 131 108	AIR COMPRESSOR GEAR	109
51.54210.0109	63 450 249	DRIVE GEAR	357
51.54210.0141	21 130 141	AIR COMPRESSOR DRIVE GEAR	106
51.54210.0182	21 130 182	AIR COMPRESSOR DRIVE GEAR	106
51.54901.0034	21 130 034	AIR COMPRESSOR GASKET	107
51.54901.0035	21 130 035	AIR COMPRESSOR GASKET	107
51.54901.0042	21 130 042	AIR COMPRESSOR GASKET	108
51.90001.0167	21 140 067	EXHAUST MANIFOLD BOLT	371
51.90001.0169	21 140 169	EXHAUST MANIFOLD BOLT	371

Umschlüsselung OEM / Cross Reference OEM

MAN	AL-HU TECH	Description	Page
51.90020.0131	21 130 051	AIR COMPRESSOR CRANKSHAFT SCRE	104
51.90020.0242	28 010 242	HEX. BOLT	406
51.90020.0298	63 451 334	HEX SCREW	406
51.90020.0381	21 010 381	CYLINDER HEAD SCREW	355
51.90201.0173	21 140 073	STUD	443
51.90310.0183	21 010 183	OIL DRAIN PLUG	417
51.90310.0198	28 310 198	DRAIN PLUG	356
51.90310.0255	63 450 257	DRAIN PLUG	357
51.90441.0114	63 450 639	EYE BOLT	378
51.90441.0127	63 450 640	EYE BOLT	379
51.90441.0137	21 468 137	EYE BOLT	378
51.90490.0022	28 010 022	CYLINDER HEAD SCREW	355
51.90490.0023	28 010 023	CYLINDER HEAD SCREW	356
51.90490.0024	28 010 024	CYLINDER HEAD SCREW	356
51.90490.0029	21 140 029	SCREW, EXHAUST MANIFOLD	440
51.90490.0030	21 140 030	SCREW, EXHAUST MANIFOLD	441
51.90490.0032	63 450 281	HEX. SCREW	406
51.90490.0079	63 453 052	CONROD SCREW	350
51.91701.0704	63 450 641	RACE	428
51.93020.0335	28 130 335	AIR COMPRESSOR BUSH	101
51.93410.0116	21 200 081	WATER PUMP BEARING	467
51.93410.0119	21 981 004	BALL BEARING	4
51.95800.6075	21 200 075	BELT TENSIONER PULLEY	339
51.95800.6092	21 200 076	BELT TENSIONER PULLEY	340
51.95800.6099	21 200 076	BELT TENSIONER PULLEY	340
51.95800.6107	21 200 075	BELT TENSIONER PULLEY	339
51.95800.7088	63 450 247	BELT TENSIONER	339
51.95800.7315	21 200 580	BELT TENSIONER	339
51.95800.7396	21 200 088	BELT TENSIONER	337
51.95800.7397	21 200 104	BELT TENSIONER	338
51.95800.7431	21 200 431	BELT TENSIONER PULLEY	340
51.95800.7435	21 200 435	BELT TENSIONER	338
51.95800.7437	21 200 089	BELT TENSIONER	338
51.95800.7459	21 200 459	BELT TENSIONER	338
51.95800.7466	63 450 642	BELT TENSIONER	339
51.95800.7480	21 200 435	BELT TENSIONER	338
51.95801.6018	63 450 643	BELT TENSIONER PULLEY	340
51.95801.6019	63 450 645	BELT TENSIONER PULLEY	340
51.95820.0039	21 200 039	V-BELT PULLEY	457
51.95840.0172	63 450 646	BELT TENSIONER PULLEY ARM	341
51.96301.0108	63 451 335	HOSE	407
51.96330.0346	21 330 346	TURBO HOSE	452
51.96330.0359	21 094 783	TURBO HOSE	450
51.96420.0121	63 450 204	TURBO HOSE	452
51.96501.0337	21 997 348	SEAL RING, SEPERATOR	442
51.96501.0348	21 997 448	DOUBLE SEAL RING	356
51.97141.0016	63 450 647	RADIATOR CAP	429
51.97141.7006	21 018 006	TANK CAP	443
51.97401.6064	21 203 023	CLAMP INJECTION LINE	347
51.97401.6065	21 203 024	CLAMP INJECTION LINE	347
51.97401.6066	21 203 025	CLAMP INJECTION LINE	347
51.97445.0033	63 450 648	PROFILED CLAMP	427
51.97445.0076	63 450 649	PROFILED CLAMP	427
51.97601.0290	21 200 090	PRESSURE SPRING	427

Umschlüsselung OEM / Cross Reference OEM

MAN	AL-HU TECH	Description	Page
51.97610.0044	28 610 044	SPRING, BELT TIGHTENER	442
51.98110.0177	63 450 251	T JUNCTION	443
51.98150.0110	63 450 650	HOLLOW SCREW	407
51.98150.0167	21 070 167	HOLLOW SCREW	406
51.98701.0065	21 997 065	INJECTOR WASHER	411
51.98701.0082	21 140 082	MULTIPIECE OIL RING	413
51.98701.0085	21 140 085	MULTIPIECE OIL RING	413
51.98701.0090	21 997 090	SEAL RING	441
51.98701.0091	21 997 091	INJECTOR WASHER	412
51.98701.0093	21 997 093	SEAL RING	441
81.05601.0017	28 560 017	OIL COOLER	415
81.06102.6118	21 500 749	EXPANSION TANK	377
81.06102.6201	21 500 549	EXPANSION TANK	377
81.06102.6202	21 500 549	EXPANSION TANK	377
81.06102.6203	21 500 047	EXPANSION TANK	376
81.06102.6204	21 500 048	EXPANSION TANK	377
81.06102.6208	21 500 949	EXPANSION TANK	378
81.06102.6209	21 500 449	EXPANSION TANK	377
81.06102.6218	21 500 549	EXPANSION TANK	377
81.06110.0007	63 450 651	RADIATOR CAP	429
81.06110.0026	21 146 050	RADIATOR CAP	428
81.06111.0018	21 146 350	RADIATOR CAP	428
81.06111.0020	21 146 351	RADIATOR CAP	428
81.06130.0141	28 613 141	INTERCOOLER	412
81.06225.6008	63 450 652	RADIATOR MOUNTING	438
81.06606.0147	63 450 255	V-BELT PULLEY	460
81.06620.0158	26 662 158	FAN SHROUD	240
81.06630.6038	63 453 043	FAN CLUTCH	390
81.06630.6039	21 201 039	FAN CLUTCH	389
81.06630.6072	21 200 002	FAN CLUTCH	384
81.06668.0006	21 470 006	HYDRAULIC OIL FILTER	190
81.08201.0332	28 830 332	HOSE BEND	255
81.08201.6028	28 830 028	INTAKE PIPE	256
81.08301.6281	21 094 002	DRY AIR CLEANER	359
81.08303.6051	21 094 051	FILTER HOUSING	391
81.08304.0023	28 000 003	FILTER HOUSING	391
81.08312.0010	21 094 050	DUST EJECTOR VALVE	360
81.08340.0145	63 451 667	SPRING, AIR FILTER	442
81.08400.6003	21 094 003	DRY AIR CLEANER	358
81.08400.6004	21 094 004	DRY AIR CLEANER	359
81.08401.6169	21 094 005	DRY AIR CLEANER	359
81.08903.0109	63 451 666	SEAL RING	441
81.10109.0024	63 450 653	NOZZLE CAP NUT	414
81.10109.0031	21 074 031	NOZZLE CAP NUT	414
81.10109.0032	63 450 654	NOZZLE CAP NUT	414
81.11101.6012	21 447 017	REPAIR KIT	439
81.11101.6151	21 447 032	REPAIR KIT	439
81.11701.6046	21 072 112	AIR CYLINDER	334
81.12101.6022	21 040 003	FUEL FEED PUMP	397
81.12150.6013	21 447 033	HAND PUMP	404
81.12210.0034	28 210 034	TANK CAP	444
81.12210.6025	21 146 352	TANK CAP	444
81.12210.6027	21 146 353	TANK CAP	444
81.12501.0022	21 470 002	WATER SEPERATOR FILTER	468

Umschlüsselung OEM / Cross Reference OEM

MAN	AL-HU TECH	Description	Page
81.12501.6082	63 450 655	FUEL PREFILTER	401
81.12503.0080	21 470 002	WATER SEPERATOR FILTER	468
81.12503.0085	21 470 001	WATER SEPERATOR FILTER	468
81.12503.0086	21 470 001	WATER SEPERATOR FILTER	468
81.12504.6011	63 450 656	FUEL PREFILTER COVER	401
81.12510.0027	63 450 657	FUEL PREFILTER VALVE	401
81.12902.6000	21 092 000	GASKET SET	403
81.12902.6001	21 092 001	GASKET SET	403
81.15210.0017	21 490 017	EXHAUST METAL HOSE	372
81.15210.0022	21 490 022	EXHAUST METAL HOSE	373
81.15210.0033	21 490 033	EXHAUST METAL HOSE	373
81.15210.0049	21 499 390	EXHAUST METAL HOSE	375
81.15210.0054	21 490 054	EXHAUST METAL HOSE	373
81.15210.0056	21 490 056	EXHAUST METAL HOSE	373
81.15210.0064	21 490 064	EXHAUST METAL HOSE	374
81.15210.0071	21 490 071	EXHAUST METAL HOSE	374
81.15210.0074	21 490 074	EXHAUST METAL HOSE	374
81.15210.0078	21 490 078	EXHAUST METAL HOSE	374
81.15210.0084	21 490 084	EXHAUST METAL HOSE	375
81.15210.0086	21 490 086	EXHAUST METAL HOSE	375
81.15210.5004	21 490 004	EXHAUST METAL HOSE	372
81.15210.5008	21 490 008	EXHAUST METAL HOSE	372
81.15402.6027	21 146 354	TANK CAP	444
81.15408.0006	29 255 006	FLUID LEVEL PROBE	474
81.15502.5120	21 491 120	EXHAUST BRACKET	364
81.15600.6081	21 140 056	EXHAUST THROTTLE	376
81.15600.6106	21 140 076	EXHAUST THROTTLE	376
81.15601.0022	21 140 056	EXHAUST THROTTLE	376
81.15601.6057	21 140 026	EXHAUST THROTTLE	376
81.15701.6079	21 140 457	AIR CYLINDER	334
81.15701.6093	21 140 458	AIR CYLINDER	335
81.15701.6112	21 140 460	AIR CYLINDER	335
81.15701.6119	63 450 658	AIR CYLINDER	335
81.15701.6120	21 140 455	AIR CYLINDER	334
81.15701.6124	63 450 659	AIR CYLINDER	336
81.25101.6289	28 820 289	HEAD LAMP	249
81.25101.6290	28 820 290	HEAD LAMP	250
81.25101.6291	28 820 291	HEAD LAMP	250
81.25101.6292	28 820 292	HEAD LAMP	250
81.25101.6338	28 820 338	HEADLIGHTS AND FOGLIGHTS RIGHT	253
81.25101.6339	28 820 339	HEADLIGHTS AND FOGLIGHTS LEFT	252
81.25101.6448	28 820 448	HEAD LAMP	250
81.25101.6449	28 820 449	HEAD LAMP	251
81.25101.6450	28 820 450	HEAD LAMP	251
81.25101.6451	28 820 451	HEAD LAMP	251
81.25101.6521	63 450 232	FOG LAMP	242
81.25101.6522	63 450 233	FOG LAMP	242
81.25102.6085	28 820 085	FOG LAMP	242
81.25110.0067	28 826 067	HEAD LAMP LENS	251
81.25110.0068	28 826 068	HEAD LAMP LENS	252
81.25110.0080	28 826 080	HEAD LAMP LENS	252
81.25110.0081	28 826 081	HEAD LAMP LENS	252
81.25110.0085	63 450 234	FOG LAMP LENS	243
81.25110.0086	63 450 235	FOG LAMP LENS	243

Umschlüsselung OEM / Cross Reference OEM

MAN	AL-HU TECH	Description	Page
81.25113.6021	28 820 339	HEADLIGHTS AND FOGLIGHTS LEFT	252
81.25113.6022	28 820 338	HEADLIGHTS AND FOGLIGHTS RIGHT	253
81.25115.0022	28 820 341	RETAINING FRAME, RIGHT	281
81.25115.0023	28 820 340	RETAINING FRAME, LEFT	281
81.25140.0096	63 450 660	LOCK PLATE	258
81.25140.0121	63 450 661	BRACKET	212
81.25225.6259	63 450 662	TAIL LAMP	299
81.25225.6260	63 450 663	TAIL LAMP	299
81.25225.6459	63 450 207	FLASHER LAMP	241
81.25225.6460	63 450 208	FLASHER LAMP	242
81.25225.6485	63 450 212	CLEARANCE LAMP	228
81.25225.6510	63 450 210	TAIL LAMP	299
81.25225.6511	63 450 209	TAIL LAMP	299
81.25225.6523	28 252 523	TAIL LAMP	297
81.25225.6524	28 252 524	TAIL LAMP	298
81.25225.6544	28 540 002	TAIL LAMP	298
81.25225.6545	28 540 022	TAIL LAMP	298
81.25225.6547	28 540 001	TAIL LAMP	298
81.25228.0014	63 451 127	HOUSING	476
81.25228.6033	28 252 033	TAIL LAMP	297
81.25228.6034	28 252 034	TAIL LAMP	297
81.25229.0603	28 229 603	LENS	257
81.25229.0784	28 252 784	REVERSE LIGHT LENS	281
81.25229.0832	28 320 001	INDICATOR LAMP	256
81.25229.0889	25 229 889	LENS	257
81.25229.6042	63 450 098	REAR LAMP LENS	278
81.25229.6051	28 252 051	TAIL LAMP LENS	300
81.25229.6059	28 540 005	TAIL LAMP LENS	300
81.25229.6060	28 540 006	TAIL LAMP LENS	300
81.25245.0144	63 450 664	BRACKET	212
81.25260.6039	63 450 099	BLINKER LAMP	207
81.25260.6074	63 450 211	CLEARANCE LAMP	228
81.25260.6101	28 820 101	SIDE MARKER LIGHT	287
81.25260.6104	28 826 104	SIDE MARKER LAMP	287
81.25260.6105	25 260 004	SIDE MARKER LIGHT	287
81.25301.6066	25 542 120	HORN 24V, 335 HZ	163
81.25310.0034	25 215 550	INDICATOR RELAY	165
81.25311.0005	25 215 350	INDICATOR RELAY	164
81.25311.0006	25 215 006	INDICATOR RELAY	164
81.25311.0023	25 215 450	INDICATOR RELAY	164
81.25320.6043	63 450 665	BLINKER LAMP	207
81.25320.6078	25 260 005	FLASHER LAMP	241
81.25320.6082	28 320 002	INDICATOR LAMP	256
81.25320.6084	25 260 006	INDICATOR LAMP	255
81.25320.6087	25 260 007	INDICATOR LAMP	256
81.25320.6088	63 450 110	BLINKER LAMP	207
81.25320.6089	28 826 089	BLINKER LAMP	205
81.25320.6090	28 826 090	BLINKER LAMP	205
81.25320.6091	28 826 111	BLINKER LAMP	205
81.25320.6092	28 826 112	BLINKER LAMP	206
81.25320.6095	63 450 097	FLASHER LAMP	241
81.25320.6096	63 450 100	FLASHER LAMP	241
81.25320.6111	28 826 111	BLINKER LAMP	205
81.25320.6112	28 826 112	BLINKER LAMP	206

Umschlüsselung OEM / Cross Reference OEM

MAN	AL-HU TECH	Description	Page
81.25320.6113	28 826 113	BLINKER LAMP	206
81.25320.6114	28 826 114	BLINKER LAMP	206
81.25320.6117	28 826 117	BLINKER LAMP	206
81.25320.6118	28 826 118	BLINKER LAMP	207
81.25444.6060	25 545 060	CENTRAL ELECTRIC	161
81.25444.6074	25 545 074	CENTRAL ELECTRIC	161
81.25501.6005	25 545 013	IGNITION SWITCH	476
81.25501.6012	25 545 006	STARTER SWITCH	493
81.25501.6020	25 545 713	IGNITION SWITCH	477
81.25501.6025	25 545 613	IGNITION SWITCH	476
81.25501.6033	25 545 513	IGNITION SWITCH	476
81.25502.0018	25 545 038	MAIN BATTERY SWITCH KEY	478
81.25503.0222	AK27501	PUSH KEY	485
81.25503.0223	25 545 223	TOGGLE SWITCH	501
81.25503.0244	29 503 244	PRESSURE SWITCH	483
81.25503.6128	25 545 128	POWER CONTROL SWITCH	480
81.25503.6131	25 545 131	TOGGLE SWITCH	501
81.25503.6209	25 545 209	TOGGLE SWITCH	501
81.25503.6243	63 450 095	PUSH BUTTON SWITCH	485
81.25503.6267	25 545 267	TOGGLE SWITCH	503
81.25503.6300	25 545 909	TOGGLE SWITCH	506
81.25503.6302	25 545 302	TOGGLE SWITCH	505
81.25505.0461	29 545 005	REVERSE LIGHT SWITCH	489
81.25505.0462	70.583.050	CHANGE-OVER SWITCH	471
81.25505.0468	25 226 468	STEERING COLUMN SWITCH	495
81.25505.0636	25 545 814	REVERSE LIGHT SWITCH	488
81.25505.0668	63 451 128	TOGGLE SWITCH	506
81.25505.0959	29 255 959	ROTARY SWITCH	490
81.25505.0975	29 255 975	ROTARY SWITCH	490
81.25505.0976	29 255 976	ROTARY SWITCH	490
81.25505.0989	28 820 010	DOOR CONTACT SWITCH	474
81.25505.0992	29 545 007	FOOT BRAKE SWITCH	475
81.25505.6131	29 255 131	BRAKE SWITCH	470
81.25505.6175	29 255 175	RETARDER SWITCH	488
81.25505.6255	25 545 255	TOGGLE SWITCH	501
81.25505.6259	25 545 259	TOGGLE SWITCH	502
81.25505.6260	25 545 260	TOGGLE SWITCH	502
81.25505.6262	25 545 262	TOGGLE SWITCH	502
81.25505.6265	25 545 265	TOGGLE SWITCH	502
81.25505.6267	25 545 268	TOGGLE SWITCH	503
81.25505.6270	25 545 270	TOGGLE SWITCH	503
81.25505.6271	25 545 271	TOGGLE SWITCH	503
81.25505.6274	25 545 274	TOGGLE SWITCH	504
81.25505.6280	25 545 280	TOGGLE SWITCH	504
81.25505.6282	25 545 282	TOGGLE SWITCH	504
81.25505.6288	25 545 288	TOGGLE SWITCH	504
81.25505.6291	25 545 291	TOGGLE SWITCH	505
81.25505.6292	25 545 292	TOGGLE SWITCH	505
81.25505.6327	25 545 327	TOGGLE SWITCH	505
81.25505.6378	25 545 378	TOGGLE SWITCH	506
81.25505.6607	25 545 607	TOGGLE SWITCH	506
81.25506.6033	25 545 037	MAIN BATTERY SWITCH	477
81.25506.6037	25 545 037	MAIN BATTERY SWITCH	477
81.25506.6120	25 545 037	MAIN BATTERY SWITCH	477

Umschlüsselung OEM / Cross Reference OEM

MAN	AL-HU TECH	Description	Page
81.25506.7000	25 545 000	MAIN BATTERY SWITCH	477
81.25507.0015	63 451 153	REVERSE LIGHT SWITCH	490
81.25509.0013	25 226 013	STEERING COLUMN SWITCH	493
81.25509.0018	25 226 909	STEERING COLUMN SWITCH	495
81.25509.0020	25 226 024	STEERING COLUMN SWITCH	493
81.25509.0034	29 255 034	STEERING COLUMN SWITCH	495
81.25509.0050	29 255 050	STEERING COLUMN SWITCH	496
81.25509.0054	29 255 054	STEERING COLUMN SWITCH	496
81.25509.0068	JL110007/80060238	RETARDER SWITCH	488
81.25509.0069	29 255 069	RETARDER SWITCH	486
81.25509.0070	29 255 070	BRAKE SWITCH	470
81.25509.0071	29 255 071	RETARDER SWITCH	486
81.25509.0072	29 255 072	RETARDER SWITCH	486
81.25509.0073	29 255 073	RETARDER SWITCH	487
81.25509.0075	29 255 075	RETARDER SWITCH	487
81.25509.0076	29 255 076	RETARDER SWITCH	487
81.25509.0078	29 255 078	STEERING COLUMN SWITCH	496
81.25509.0079	29 255 079	STEERING COLUMN SWITCH	496
81.25509.0084	29 255 084	RETARDER SWITCH	487
81.25509.0116	25 226 921	STEERING COLUMN SWITCH	495
81.25509.0123	25 226 118	STEERING COLUMN SWITCH	494
81.25509.0124	25 226 117	STEERING COLUMN SWITCH	494
81.25509.0125	29 255 125	EXHAUST BRAKE SWITCH	474
81.25509.0126	29 255 126	STEERING COLUMN SWITCH	497
81.25509.0127	29 255 127	STEERING COLUMN SWITCH	497
81.25509.0129	29 255 129	STEERING COLUMN SWITCH	497
81.25509.0130	29 255 130	STEERING COLUMN SWITCH	497
81.25509.0139	29 255 139	STEERING COLUMN SWITCH	498
81.25509.0144	25 226 118	STEERING COLUMN SWITCH	494
81.25509.0148	29 255 148	STEERING COLUMN SWITCH	498
81.25509.6056	25 226 056	STEERING COLUMN SWITCH	493
81.25514.0035	29 255 035	PRESSURE SWITCH	480
81.25520.0021	21 545 008	BRAKE LIGHT SWITCH	469
81.25520.0043	63 451 485	PRESSURE SWITCH	484
81.25520.0076	29 255 176	CONTROL SWITCH	473
81.25520.0079	29 255 179	CONTROL SWITCH	471
81.25520.0088	29 255 088	BRAKE SWITCH	470
81.25520.0089	29 255 089	SENSOR	491
81.25520.0100	29 255 100	CONTROL SWITCH	471
81.25520.0104	29 255 104	CONTROL SWITCH	472
81.25520.0106	29 255 106	CONTROL SWITCH	472
81.25520.0107	29 255 107	CONTROL SWITCH	472
81.25520.0117	29 255 117	CONTROL SWITCH	472
81.25520.0149	29 255 149	BRAKE SWITCH	470
81.25520.0152	25 545 152	BRAKE SWITCH	469
81.25520.0152	29 255 152	BRAKE SWITCH	471
81.25520.0162	29 255 162	CONTROL SWITCH	473
81.25520.0163	29 255 163	PRESSURE SWITCH	481
81.25520.0167	29 255 167	PRESSURE SWITCH	481
81.25520.0169	29 255 169	SENSOR	491
81.25520.0171	29 255 171	BRAKE LIGHT SWITCH	469
81.25520.0172	29 255 172	SENSOR	491
81.25520.0173	29 255 173	SENSOR	491
81.25520.0176	29 255 276	SENSOR	492

Umschlüsselung OEM / Cross Reference OEM

MAN	AL-HU TECH	Description	Page
81.25520.0177	29 255 177	PRESSURE SWITCH	481
81.25520.0184	29 255 184	PRESSURE SWITCH	481
81.25520.0187	29 255 187	PRESSURE SWITCH	482
81.25520.0190	29 255 190	PRESSURE SWITCH	482
81.25520.0191	29 255 191	PRESSURE SWITCH	482
81.25520.0195	29 255 195	PRESSURE SWITCH	482
81.25520.0209	29 255 209	PRESSURE SWITCH	483
81.25520.0210	29 255 210	PRESSURE SWITCH	483
81.25520.0214	29 255 214	SENSOR	492
81.25520.6007	63 453 051	BRAKE LIGHT SWITCH	469
81.25521.6017	63 451 483	PRESSURE SWITCH	483
81.25525.0032	29 525 032	REVERSE LIGHT SWITCH	489
81.25525.0033	29 525 033	REVERSE LIGHT SWITCH	489
81.25525.0156	29 525 156	REVERSE LIGHT SWITCH	489
81.25525.0227	29 525 033	REVERSE LIGHT SWITCH	489
81.25525.0257	29 525 033	REVERSE LIGHT SWITCH	489
81.25601.0011	21 192 005	VOLTAGE REGULATOR	172
81.25601.0025	21 311 558	VOLTAGE REGULATOR	173
81.25601.6030	21 192 014	VOLTAGE REGULATOR	172
81.25601.6035	21 311 301	VOLTAGE REGULATOR	172
81.25902.0058	63 451 129	RELAY	486
81.25902.0203	29 542 819	STARTER INTERLOCK	169
81.25902.0376	25 545 376	RELAIS	166
81.25902.0378	25 545 478	SPEED SENSOR	168
81.25902.0410	25 545 410	RELAIS	166
81.25902.0441	25 545 497	CONTROL UNIT, GLOW PLUG SYSTEM	162
81.25902.0469	25 545 469	RELAIS	167
81.25902.0473	25 545 473	RELAIS	167
81.25902.0474	25 545 474	RELAY, 2-WAY CONTACT	167
81.25902.0497	25 545 497	CONTROL UNIT, GLOW PLUG SYSTEM	162
81.25902.0519	25 545 519	LOAD RELAY	165
81.25902.0524	25 545 524	RELAIS	438
81.25902.6175	22 902 175	ECAS VALVE REPAIR KIT	128
81.25902.6267	29 255 267	RELAY	485
81.25902.6268	29 255 268	RELAY	485
81.25907.0225	25 545 225	POTENTIOMETER SWITCH	479
81.25907.0287	29 288 287	POTENTIOMETER	479
81.25907.0295	29 255 295	POTENTIOMETER	479
81.25921.6051	21 014 070	CARBON BRUSH SET	160
81.25921.6058	21 014 079	CARBON BRUSH SET	161
81.25927.0099	25 927 099	DIODE RELAY	473
81.25927.0107	25 545 107	RELAIS	166
81.25935.6534	63 450 011	RELAY	439
81.25935.6706	29 255 706	ELECTRONIC CONTROL	474
81.25937.0014	63 450 795	ECAS HEIGHT SENSOR	127
81.25937.0015	22 937 015	ECAS HEIGHT SENSOR	127
81.25937.0016	22 937 016	ECAS HEIGHT SENSOR	127
81.25937.0040	63 450 796	ECAS HEIGHT SENSOR	127
81.25937.6011	13 815 601	BRAKE WEAR INDICATOR	125
81.25937.6012	13 815 022	BRAKE WEAR INDICATOR	125
81.25943.6009	29 943 009	TRANSFORMER 24>12V DC	507
81.26100.6029	63 450 236	REPAIR KIT	167
81.26101.6084	21 689 541	ALTERNATOR	159
81.26109.0014	63 451 653	RECTIFIER	165

Umschlüsselung OEM / Cross Reference OEM

MAN	AL-HU TECH	Description	Page
81.26109.0018	63 453 042	RECTIFIER ASSY	166
81.26203.6007	21 005 025	ARMATURE	160
81.26203.6018	21 005 022	ARMATURE	159
81.26203.6019	21 005 023	ARMATURE	160
81.26203.6020	21 005 023	ARMATURE	160
81.26204.0013	21 004 036	FIELD COIL	163
81.26204.0032	21 004 078	FIELD COIL	163
81.26204.0033	21 004 083	FIELD COIL	163
81.26207.0021	21 880 166	COMMUTATOR END SHIELD	161
81.26209.0015	21 006 020	STARTER PINION	171
81.26209.0016	21 209 422	STARTER PINION	171
81.26212.0011	21 101 006	SOLENOID SWITCH	168
81.26212.0012	21 450 001	SOLENOID SWITCH	168
81.26212.0017	21 450 001	SOLENOID SWITCH	168
81.26214.0003	21 003 040	ENGAGEMENT ROD	162
81.26215.6014	21 825 218	DRIVE BEARING, STARTER	162
81.26225.6003	21 401 527	STARTER CLUTCH	169
81.26401.6051	28 820 001	WIPER MOTOR	315
81.26401.6087	63 451 654	WIPER MOTOR	317
81.26401.6118	28 820 002	WIPER MOTOR	316
81.26401.6119	28 820 142	WIPER MOTOR	317
81.26401.6127	28 820 003	WIPER MOTOR	316
81.26401.6137	28 820 004	WIPER MOTOR	316
81.26401.6141	28 820 005	WIPER MOTOR	316
81.26411.0093	63 451 130	CONNECTING LINK	228
81.26411.0094	63 451 131	CONNECTING LINK	228
81.26411.0095	63 451 132	CONNECTING LINK	229
81.26411.6089	28 820 089	WIPER LINKAGE	314
81.26411.6090	28 820 090	WIPER LINKAGE	315
81.26411.6091	28 820 091	WIPER LINKAGE	315
81.26411.6092	28 820 009	WIPER LINKAGE	314
81.26411.6111	28 820 111	WIPER LINKAGE	315
81.26411.6112	28 820 011	WIPER LINKAGE	314
81.26411.6113	28 264 113	WIPER LINKAGE	314
81.26421.0066	26 421 066	WIPER PIVOT-SHAFT	317
81.26421.0067	26 421 067	WIPER PIVOT-SHAFT	317
81.26421.0068	26 421 068	LEVER, WINDSCREEN WIPER	257
81.26421.6042	63 450 246	WIPER BEARING	313
81.26430.0080	26 430 080	WIPER ARM	312
81.26430.0081	63 450 666	WIPER ARM	313
81.26430.0083	28 820 083	WIPER ARM	313
81.26430.6057	28 820 006	WIPER ARM	312
81.26430.6058	28 820 008	WIPER ARM	313
81.26430.6059	28 820 007	WIPER ARM	312
81.26481.0026	26 481 026	LOCK, WATER CONTAINER	259
81.26485.6008	28 869 008	WINDSHIELD WASHER PUMP	311
81.26485.6016	28 869 221	WINDSHIELD WASHER PUMP	311
81.26485.6027	28 869 321	WINDSHIELD WASHER PUMP	312
81.26485.6033	28 869 033	WINDSHIELD WASHER PUMP	311
81.27120.0016	63 450 667	PULSE GENERATOR	484
81.27120.6064	63 450 756	ABS SENSOR	93
81.27120.6065	63 450 757	ABS SENSOR	93
81.27120.6146	63 450 762	ABS SENSOR	94
81.27120.6147	63 450 763	ABS SENSOR	94

Umschlüsselung OEM / Cross Reference OEM

MAN	AL-HU TECH	Description	Page
81.27120.6149	22 120 149	ABS SENSOR	92
81.27120.6150	63 450 765	ABS SENSOR	95
81.27120.6151	22 120 151	ABS SENSOR	92
81.27120.6151	63 450 766	ABS SENSOR	95
81.27120.6156	22 120 156	ABS SENSOR	92
81.27120.6157	63 450 768	ABS SENSOR	95
81.27120.6164	63 450 759	ABS SENSOR	93
81.27120.6165	63 450 758	ABS SENSOR	93
81.27120.6168	63 450 761	ABS SENSOR	94
81.27120.6169	63 450 760	ABS SENSOR	94
81.27120.6182	63 450 781	ABS SENSOR	97
81.27120.6183	63 450 782	ABS SENSOR	97
81.27120.6184	63 450 783	ABS SENSOR	97
81.27120.6185	63 450 784	ABS SENSOR	97
81.27120.6186	63 450 778	ABS SENSOR	96
81.27120.6187	63 450 779	ABS SENSOR	96
81.27120.6189	63 450 780	ABS SENSOR	96
81.27120.6209	63 450 776	ABS SENSOR	95
81.27120.6210	63 450 777	ABS SENSOR	96
81.27202.6146	29 255 146	INDICATOR	477
81.27420.0085	29 545 014	TEMPERATURE SENSOR	500
81.27421.0056	25 545 714	REVERSE LIGHT SWITCH	488
81.27421.0088	63 450 213	OIL PRESSURE SENDER	478
81.27421.0097	25 542 097	OIL PRESSURE SWITCH	478
81.27421.0109	25 542 109	OIL PRESSURE SENDER	478
81.27421.0125	29 545 012	TEMPERATURE SENDER	498
81.27421.0135	29 421 135	PULSE GENERATOR	484
81.27421.0137	29 421 137	PULSE GENERATOR	484
81.27421.0151	29 421 151	PRESSURE SENSOR	480
81.27421.0152	63 450 010	WATER LEVEL SENSOR	507
81.27421.0189	63 450 008	WATER LEVEL SENSOR	507
81.27421.0204	29 255 204	SENSOR	492
81.27421.0227	29 421 077	PRESSURE SENSOR	480
81.27421.0231	29 255 231	VACUUM SWITCH	507
81.27421.0232	63 450 060	FLUID LEVEL PROBE	475
81.27421.0264	29 421 264	TEMPERATURE SENSOR	500
81.27430.0005	29 545 006	OIL PRESSURE SWITCH	479
81.28601.6011	28 831 108	BLOWER MOTOR	209
81.30300.6002	21 252 646	CLUTCH REPAIR KIT	185
81.30300.6003	21 252 646	CLUTCH REPAIR KIT	185
81.30300.6004	25 250 010	CLUTCH REPAIR KIT	185
81.30530.0037	63 451 665	CLUTCH FORK	179
81.30550.0050	63 450 668	CLUTCH RELEASE BEARING	184
81.30550.0056	63 450 669	CLUTCH RELEASE BEARING	184
81.30550.0082	21 250 082	CLUTCH RELEASE BEARING	182
81.30550.0085	21 250 085	CLUTCH RELEASE BEARING	183
81.30550.0105	21 250 105	CLUTCH RELEASE BEARING	183
81.30550.0110	21 250 110	CLUTCH RELEASE BEARING	183
81.30550.0116	21 250 109	CLUTCH RELEASE BEARING	183
81.30550.0117	21 250 002	CLUTCH RELEASE BEARING	182
81.30550.0251	63 450 670	CLUTCH RELEASE BEARING	184
81.30560.0050	21 250 050	CLUTCH OPERATING LEVER	182
81.30560.0055	21 255 055	CLUTCH PIVOT	182
81.30560.0061	25 250 001	CLUTCH RELEASE LEVER	185

Umschlüsselung OEM / Cross Reference OEM

MAN	AL-HU TECH	Description	Page
81.30560.0063	21 250 063	CLUTCH RELEASE LEVER	185
81.30560.0078	63 451 664	RELEASE LEVER	192
81.30560.6019	21 250 019	CLUTCH FORK REPAIR KIT	179
81.30715.6040	21 290 011	CLUTCH MASTER CYLINDER	180
81.30715.6051	21 290 051	CLUTCH MASTER CYLINDER	180
81.30715.6104	63 450 671	REPAIR KIT	192
81.30715.6113	21 290 113	CLUTCH CYLINDER REPAIR KIT	178
81.30715.6115	21 250 115	CLUTCH MASTER CYLINDER	180
81.30715.6116	21 290 116	CLUTCH MASTER CYLINDER	180
81.30715.6117	63 450 672	CLUTCH MASTER CYLINDER	181
81.30715.6118	21 290 118	CLUTCH CYLINDER REPAIR KIT	179
81.30715.6119	21 290 119	CLUTCH MASTER CYLINDER	181
81.30715.6120	21 290 120	CLUTCH MASTER CYLINDER	181
81.30715.6126	63 450 673	REPAIR KIT	193
81.30715.6135	21 290 135	CLUTCH MASTER CYLINDER	181
81.30716.6044	63 450 674	CLUTCH SLAVE CYLINDER	186
81.30716.6057	63 450 675	CLUTCH SLAVE CYLINDER	186
81.30716.6071	63 450 676	REPAIR KIT	193
81.30716.6082	63 450 677	CLUTCH SLAVE CYLINDER	186
81.30725.6026	24 051 111	CLUTCH BOOSTER	176
81.30725.6040	24 051 905	CLUTCH BOOSTER KIT	178
81.30725.6053	24 051 157	CLUTCH BOOSTER	176
81.30725.6065	24 051 307	CLUTCH BOOSTER	177
81.30725.6069	24 051 406	CLUTCH BOOSTER	177
81.30725.6084	24 051 412	CLUTCH BOOSTER	177
81.30725.6104	24 051 441	CLUTCH BOOSTER	178
81.32404.0002	21 255 002	BEARING BRACKET	175
81.32411.0007	21 250 007	CLUTCH RELEASE LEVER	184
81.32510.0013	616709	THRUST PIECE	201
81.32526.0031	616710	SLIDING BLOCK	200
81.32527.0022	21 527 022	DOUBLE GROOVED RING	188
81.32545.0033	63 450 111	LATCH STOP	191
81.32550.0003	22 260 357	SHIFTING VALVE	199
81.32550.0012	22 550 012	MAGNETIC VALVE	191
81.32580.0007	25 580 007	BLEEDER VALVE	175
81.32605.6111	25 605 111	SHIFT MECHANISM	198
81.32616.0007	22 260 007	INSULATING ELEMENT	190
81.32616.0011	63 450 678	INSULATING ELEMENT	191
81.32616.0013	22 260 008	INSULATING ELEMENT	190
81.32620.0043	22 260 004	SHIFT KNOB	195
81.32620.0044	22 260 005	SHIFT KNOB	196
81.32620.0045	22 260 045	SHIFT KNOB	197
81.32620.0046	22 260 006	SHIFT KNOB	196
81.32620.0049	22 260 003	SHIFT KNOB	195
81.32620.0050	22 260 014	SHIFT KNOB	197
81.32620.0091	63 451 510	SHIFT KNOB	198
81.32620.0101	63 450 679	GEARSHIFT LEVER COVER	189
81.32620.0102	63 450 680	GEARSHIFT LEVER COVER	189
81.32620.0106	63 450 681	GEARSHIFT LEVER HANDLE	189
81.32655.6072	63 450 682	BOWDEN CABLE	210
81.32655.6074	63 450 683	BOWDEN CABLE	210
81.32655.6115	22 655 182	SHIFT CYLINDER	194
81.32655.6157	25 655 157	REPAIR KIT, SHIFT MECHANISM	194
81.32655.6180	63 450 684	REPAIR KIT GEAR SHIFT COVER	193

Umschlüsselung OEM / Cross Reference OEM

MAN	AL-HU TECH	Description	Page
81.32655.6181	63 451 137	SHIFT MECHANISM	198
81.32655.6182	22 655 182	SHIFT CYLINDER	194
81.32655.6249	63 451 402	BOWDEN CABLE	211
81.32670.6199	25 670 199	GEARSHIFT LEVER REPAIR KIT	189
81.32670.6259	63 451 336	REPAIR KIT	193
81.32734.6001	22 260 457	MULTIWAY VALVE	192
81.32734.6015	25 260 003	SHIFTING VALVE	200
81.32734.6027	22 260 857	SHIFTING VALVE	200
81.32735.6040	22 422 010	SHIFTING CYLINDER	199
81.32735.6041	22 422 012	SHIFTING CYLINDER	199
81.32735.6047	63 450 810	CLUTCH BOOSTER	178
81.33901.6046	21 470 046	GEARBOX OIL FILTER	188
81.35114.0086	21 114 086	HUB CAP	31
81.35204.0018	616701	THRUST WASHER	79
81.35401.0059	23 323 059	TRUNNION	80
81.35401.0089	23 323 089	TRUNNION	81
81.35401.0135	63 450 685	TRUNNION	81
81.35412.0009	63 451 152	SEAL HOLDER	54
81.35604.0017	63 450 102	OUTPUT SHAFT	38
81.35611.0017	616702	DRIVE SHAFT	25
81.35614.0001	63 450 104	SELECTOR FORK	54
81.35631.0006	63 450 105	SHIFT CYLINDER	54
81.35701.0141	23 356 141	WHEEL HUB	91
81.35701.0146	21 356 038	WHEEL HUB	91
81.35701.0147	21 356 039	WHEEL HUB	91
81.35701.0155	21 356 009	WHEEL HUB	88
81.35701.0159	21 356 010	WHEEL HUB	88
81.35710.0044	23 356 415	PRESSURE RING	40
81.35710.0045	23 356 215	PRESSURE RING	40
81.35710.6008	21 710 002	TRUST RING REPAIR KIT	81
81.35710.6016	21 710 001	TRUST RING REPAIR KIT	81
81.36305.6004	21 330 001	KING PIN SET	32
81.36415.6035	63 450 067	UNIVERSAL JOINT	84
81.36501.0091	21 356 013	WHEEL HUB	89
81.36501.0107	21 356 037	WHEEL HUB	90
81.39100.6007	63 450 016	UNIVERSAL JOINT	83
81.39108.6050	63 450 021	UNIVERSAL JOINT	83
81.39108.6052	63 450 017	UNIVERSAL JOINT	83
81.39108.6053	63 450 068	UNIVERSAL JOINT	84
81.39108.6055	63 450 021	UNIVERSAL JOINT	83
81.39108.6229	63 450 555	UNIVERSAL JOINT	84
81.39115.0207	63 450 103	DRIVING FLANGE	26
81.39115.5030	21 350 445	FLANGE	29
81.39115.5042	63 450 686	DRIVING FLANGE	26
81.39115.5061	63 450 013	DRIVING FLANGE	25
81.39115.5067	21 115 567	DRIVING FLANGE	25
81.39115.5068	63 450 069	DRIVING FLANGE	25
81.39126.6009	63 450 001	UNIVERSAL JOINT	82
81.39126.6020	21 410 004	UNIVERSAL JOINT	82
81.39126.6029	63 450 028	UNIVERSAL JOINT	84
81.39126.6030	63 450 002	UNIVERSAL JOINT	82
81.39126.6033	63 450 004	UNIVERSAL JOINT	82
81.39324.6068	63 450 158	PROPELLER SHAFT	41
81.39324.6070	63 450 159	PROPELLER SHAFT	41

Umschlüsselung OEM / Cross Reference OEM

MAN	AL-HU TECH	Description	Page
81.39335.6110	63 450 079	PROPELLER SHAFT	40
81.39374.6001	63 450 015	UNIVERSAL JOINT	83
81.39374.6004	63 450 004	UNIVERSAL JOINT	82
81.39410.6017	24 410 017	PROPELLER SHAFT BEARING	41
81.39410.6018	24 410 018	PROPELLER SHAFT BEARING	41
81.39410.6019	24 410 017	PROPELLER SHAFT BEARING	41
81.39410.6021	24 410 021	PROPELLER SHAFT BEARING	42
81.39410.6023	24 410 023	PROPELLER SHAFT BEARING	42
81.39410.6028	63 450 003	INTERMEDIATE BEARING	31
81.39410.6031	24 410 023	PROPELLER SHAFT BEARING	42
81.39410.6032	63 450 018	PROPELLER SHAFT BEARING	42
81.39410.6034	24 410 023	PROPELLER SHAFT BEARING	42
81.39410.6037	63 450 107	PROPELLER SHAFT BEARING	42
81.39460.0003	21 410 003	THREADED ROD	79
81.41301.0241	23 320 241	BRACKET	15
81.41301.0253	23 324 253	SPRING BRACKET	62
81.41301.5106	23 325 106	BRACKET	15
81.41301.6114	23 322 110	SPRING BRACKET	61
81.41301.6115	23 322 111	SPRING BRACKET	62
81.41302.0021	21 302 021	WASHER	87
81.41302.0030	23 326 030	WASHER	88
81.41303.0079	23 324 079	SPRING SHACKLE	68
81.41304.0040	23 324 040	SPRING BUSHING	63
81.41304.0041	63 451 337	SPRING BUSHING	64
81.41304.0042	63 451 338	SPRING BUSHING	64
81.41304.0043	63 451 339	SPRING BUSHING	65
81.41304.0050	63 451 340	SPRING BUSHING	65
81.41320.0065	23 325 065	SPRING SADDLE	68
81.41350.0009	23 325 001	SPRING HANGER	66
81.41350.0017	23 326 017	SPRING HANGER	67
81.41350.0018	23 325 018	SPRING HANGER	67
81.41351.0006	23 351 006	OIL SEAL	192
81.41352.0002	23 320 002	CAP	18
81.41352.0009	23 323 009	CAP	18
81.41353.0001	23 356 001	PROTECTIVE RING	43
81.41355.0001	23 356 002	LOCK RING	37
81.41401.0055	63 451 341	RUBBER MOUNTING	46
81.41405.0004	23 324 004	GLIDER PLATE	30
81.41405.0012	23 324 012	GLIDER PLATE	30
81.41506.0096	28 240 002	ENGINE MOUNTING	362
81.41506.6195	63 451 342	RUBBER MOUNTING	47
81.41610.0150	28 880 150	FLAP, LOWER	240
81.41610.0151	28 880 151	BUMPER END PANEL	217
81.41610.0152	28 880 152	BUMPER END PANEL	217
81.41610.0158	28 880 158	COVER	231
81.41610.0159	28 880 159	COVER	231
81.41610.0160	63 450 576	TRIM RIGHT	303
81.41610.0161	63 450 577	TRIM LEFT	303
81.41610.0164	28 880 164	TRIM	302
81.41610.0166	28 880 166	TRIM	302
81.41610.0167	28 880 167	TRIM	303
81.41610.0191	28 880 191	FLAP, UPPER	240
81.41610.0226	26 610 226	CORNER COVER, RIGHT	230
81.41610.0227	28 880 227	CORNER LEFT	230

Umschlüsselung OEM / Cross Reference OEM

MAN	AL-HU TECH	Description	Page
81.41610.0228	28 880 228	CORNER RIGHT	231
81.41610.0229	26 416 229	BUMPER PANEL	217
81.41610.0230	26 416 230	BUMPER PANEL	218
81.41610.0231	26 610 231	BUMPER END PANEL	216
81.41610.0232	26 610 232	BUMPER END PANEL	216
81.41610.0305	28 880 305	BUMPER	214
81.41610.0306	28 880 306	BUMPER	214
81.41610.0307	26 610 307	BUMPER	213
81.41610.0308	26 610 308	BUMPER	213
81.41610.0361	26 660 000	BUMPER	213
81.41610.0364	26 660 001	BUMPER	214
81.41610.0369	26 660 002	BUMPER END PANEL	216
81.41610.0370	26 660 003	BUMPER END PANEL	217
81.41610.4114	28 880 114	BUMPER	214
81.41613.0071	28 880 071	AIR DAM 350 MM	202
81.41613.0073	28 880 073	AIR DAM 250 MM	202
81.41613.0074	28 880 074	AIR DAM 190 MM	202
81.41613.0076	28 880 076	AIRDAM END PANEL RIGHT	203
81.41613.0077	28 880 077	AIRDAM END PANEL LEFT	202
81.41613.0078	28 880 078	AIRDAM END PANEL RIGHT	203
81.41613.0079	28 880 079	AIRDAM END PANEL, LEFT	203
81.41613.0080	28 880 080	AIRDAM END PANEL, RIGHT	204
81.41613.0081	28 880 081	AIRDAM END PANEL, LEFT	203
81.41613.5035	28 880 035	AIRDAM MOUNTING	204
81.41614.0023	26 660 004	BUMPER CORNER	215
81.41614.0024	26 660 005	BUMPER CORNER	215
81.41615.5061	28 880 061	FOOTHOLD	243
81.41685.0029	63 453 025	BUMPER COVER	216
81.41685.0044	28 880 044	TRIM	302
81.41700.6095	63 450 093	REP. KIT, CAB SUSPENSION	280
81.41700.6096	63 450 151	REPAIR KIT	43
81.41701.5344	23 323 344	CAB SUPPORT	17
81.41701.5345	23 323 345	CAB SUPPORT	17
81.41715.6010	23 323 010	LOCATING ARM	36
81.41715.6013	28 890 013	REP. KIT CABIN MOUNTING	280
81.41715.6014	28 890 014	REP. KIT CABIN MOUNTING	280
81.41720.0090	28 417 090	JOINT BEARING	257
81.41720.0091	28 417 091	BRACKET LEFT	213
81.41722.6012	28 890 012	CABIN SHOCK ABSORBER	226
81.41722.6013	28 891 013	CABIN SHOCK ABSORBER	226
81.41722.6050	63 450 023	CABIN SHOCK ABSORBER	227
81.41722.6051	28 890 051	CABIN SHOCK ABSORBER	226
81.41722.6052	28 890 052	CABIN SHOCK ABSORBER	226
81.41722.6057	28 890 005	CABIN SHOCK ABSORBER	225
81.41722.6058	28 890 004	CABIN SHOCK ABSORBER	225
81.41722.6073	28 890 005	CABIN SHOCK ABSORBER	225
81.41722.6077	28 890 003	CABIN SHOCK ABSORBER	225
81.41723.0067	63 450 115	BUSH, CABIN TILT	218
81.41723.6076	28 553 305	CABIN CYLINDER	219
81.41723.6099	28 553 005	CABIN CYLINDER	219
81.41723.6114	28 553 101	CABIN PUMP	224
81.41723.6123	28 553 105	CABIN CYLINDER	219
81.41723.6124	28 553 205	CABIN CYLINDER	219
81.41860.0058	21 541 058	BATTERY COVER	204

Umschlüsselung OEM / Cross Reference OEM

MAN	AL-HU TECH	Description	Page
81.41860.6090	21 541 090	BATTERY COVER	204
81.42950.0046	28 881 046	REFLECTOR	278
81.42950.0060	28 881 060	REFLECTOR	278
81.42950.0071	28 881 071	REFLECTOR YELLOW	278
81.43220.6073	23 350 109	BALL JOINT REPAIR KIT	10
81.43220.6092	23 350 092	CONTROL ARM	20
81.43220.6093	23 350 125	CONTROL ARM	22
81.43220.6097	23 350 097	CONTROL ARM	21
81.43220.6107	23 350 107	BALL JOINT REPAIR KIT	10
81.43220.6108	23 350 108	BALL JOINT REPAIR KIT	10
81.43220.6112	23 350 112	CONTROL ARM	21
81.43220.6129	23 350 097	CONTROL ARM	21
81.43220.6135	23 350 137	CONTROL ARM	23
81.43220.6137	23 350 137	CONTROL ARM	23
81.43220.6174	63 450 442	CONTROL ARM	320
81.43220.6183	23 350 111	CONTROL ARM	21
81.43220.6185	23 350 018	CONTROL ARM	19
81.43220.6189	23 350 017	CONTROL ARM	19
81.43220.6190	23 350 016	CONTROL ARM	19
81.43220.6196	23 350 196	CONTROL ARM	23
81.43220.6202	23 350 113	BALL JOINT REPAIR KIT	10
81.43220.6203	23 350 015	BALL JOINT REPAIR KIT	8
81.43220.6204	23 350 204	BALL JOINT REPAIR KIT	11
81.43220.6215	63 450 243	CONTROL ARM	24
81.43220.6220	23 350 220	CONTROL ARM	23
81.43220.6229	23 350 229	CONTROL ARM	23
81.43220.6236	23 350 236	CONTROL ARM	24
81.43220.6244	23 350 114	BALL JOINT REPAIR KIT	11
81.43220.6250	23 350 250	BALL JOINT REPAIR KIT	12
81.43220.6268	23 350 229	CONTROL ARM	23
81.43220.6275	23 350 115	CONTROL ARM	320
81.43220.6285	23 350 001	BALL JOINT REPAIR KIT	6
81.43220.6322	23 352 505	BALL JOINT REPAIR KIT	12
81.43220.9236	23 350 236	CONTROL ARM	24
81.43230.6037	23 350 121	CONTROL ARM	22
81.43230.6043	23 350 043	BALL JOINT REPAIR KIT	8
81.43230.6051	23 350 051	BALL JOINT REPAIR KIT	9
81.43230.6058	23 350 058	CONTROL ARM	19
81.43230.6060	63 451 343	BALL JOINT REPAIR KIT	13
81.43230.6061	23 350 116	BALL JOINT REPAIR KIT	11
81.43250.6007	63 450 443	CONTROL ARM	320
81.43250.6009	23 350 009	BALL JOINT REPAIR KIT	7
81.43270.6040	23 350 117	BALL JOINT REPAIR KIT	11
81.43270.6047	63 451 344	BALL JOINT REPAIR KIT	13
81.43270.6065	23 350 065	BALL JOINT REPAIR KIT	9
81.43270.6072	23 350 004	BALL JOINT REPAIR KIT	7
81.43270.6076	23 350 076	CONTROL ARM	20
81.43270.6077	23 350 118	CONTROL ARM	21
81.43270.6079	23 350 079	BALL JOINT REPAIR KIT	9
81.43270.6080	23 350 010	BALL JOINT REPAIR KIT	7
81.43270.6087	23 350 087	CONTROL ARM	20
81.43270.6091	63 451 066	BALL JOINT REPAIR KIT	12
81.43270.6096	23 350 096	CONTROL ARM	20
81.43270.6097	63 453 056	CONTROL ARM	321

Umschlüsselung OEM / Cross Reference OEM

MAN	AL-HU TECH	Description	Page
81.43270.6100	23 350 003	BALL JOINT REPAIR KIT	6
81.43270.6105	23 350 106	BALL JOINT REPAIR KIT	9
81.43270.6110	23 350 905	BALL JOINT REPAIR KIT	12
81.43270.6117	23 350 128	CONTROL ARM	22
81.43270.6119	63 451 067	BALL JOINT REPAIR KIT	13
81.43270.6133	23 350 011	BALL JOINT REPAIR KIT	7
81.43270.6137	23 350 126	CONTROL ARM	22
81.43271.0029	63 451 345	RUBBER MOUNTING	47
81.43271.0074	23 325 074	STABILIZER MOUNTING	72
81.43271.0078	23 326 078	STABILIZER MOUNTING	75
81.43271.0080	23 326 080	STABILIZER MOUNTING	75
81.43271.0081	23 323 081	STABILIZER MOUNTING	71
81.43271.0082	23 326 082	STABILIZER MOUNTING	75
81.43271.0083	23 326 083	STABILIZER MOUNTING	75
81.43271.0087	63 451 346	RUBBER MOUNTING	47
81.43315.0009	23 331 009	BALL JOINT REPAIR KIT	6
81.43316.0021	23 326 025	STABILIZER MOUNTING	72
81.43402.6058	63 450 283	PARABOLIC SPRING	39
81.43402.6217	63 453 054	PARABOLIC SPRING	39
81.43402.6224	63 453 054	PARABOLIC SPRING	39
81.43402.6225	63 450 094	PARABOLIC SPRING	39
81.43402.6300	63 453 055	PARABOLIC SPRING	39
81.43402.6320	63 453 055	PARABOLIC SPRING	39
81.43407.0102	21 000 010	SPRING PAD	67
81.43407.0112	63 451 347	RUBBER MOUNTING	47
81.43407.5003	21 000 011	SPRING PAD	68
81.43603.0041	63 450 184	AIR SPRING BASE	2
81.43603.0044	63 450 155	AIR SPRING BASE	2
81.43603.0047	63 450 570	AIR SPRING BASE	3
81.43603.0055	63 450 185	AIR SPRING BASE	3
81.43603.0060	63 450 186	AIR SPRING BASE	3
81.43603.0062	63 450 183	AIR SPRING BASE	2
81.43609.6008	24 001 100	RELAY VALVE	134
81.43610.6054	23 500 094	AIR SPRING VALVE	116
81.43610.6061	23 500 095	AIR SPRING VALVE	117
81.43610.6129	23 500 003	AIR SPRING VALVE	116
81.43610.6134	63 450 816	CONTAINER VALVE	126
81.43618.6008	24 000 003	LOAD SENSING VALVE	131
81.43640.5114	26 640 114	BRACKET	212
81.43701.6584	63 453 007	SHOCK ABSORBER	59
81.43701.6713	63 450 065	SHOCK ABSORBER	56
81.43701.6714	63 450 034	SHOCK ABSORBER	55
81.43701.6715	63 450 066	SHOCK ABSORBER	57
81.43701.6793	63 450 050	SHOCK ABSORBER	56
81.43701.6794	63 450 038	SHOCK ABSORBER	55
81.43701.6830	63 450 077	SHOCK ABSORBER	57
81.43701.6842	63 450 138	SHOCK ABSORBER	58
81.43701.6890	63 450 037	SHOCK ABSORBER	55
81.43701.6893	63 450 035	SHOCK ABSORBER	55
81.43701.6900	63 450 081	SHOCK ABSORBER	57
81.43701.6904	63 453 009	SHOCK ABSORBER	60
81.43701.6911	63 450 039	SHOCK ABSORBER	56
81.43701.6924	63 450 078	SHOCK ABSORBER	57
81.43701.6927	63 450 040	SHOCK ABSORBER	56

Umschlüsselung OEM / Cross Reference OEM

MAN	AL-HU TECH	Description	Page
81.43701.6948	63 450 117	SHOCK ABSORBER	58
81.43701.6964	63 450 116	SHOCK ABSORBER	58
81.43702.6077	63 450 813	SHOCK ABSORBER	59
81.43704.0025	63 451 348	RUBBER MOUNTING	48
81.43704.0029	23 323 029	STABILIZER MOUNTING	69
81.43704.0032	23 326 032	STABILIZER MOUNTING	72
81.43704.0038	63 451 349	RUBBER MOUNTING	48
81.43704.0045	63 451 113	STABILIZER MOUNTING	78
81.43704.0053	63 451 350	RUBBER MOUNTING	48
81.43704.0057	23 323 057	STABILIZER MOUNTING	70
81.43704.0060	23 326 060	STABILIZER MOUNTING	73
81.43704.0061	23 326 061	STABILIZER MOUNTING	73
81.43704.0074	23 323 074	STABILIZER MOUNTING	70
81.43704.0076	63 450 239	STABILIZER MOUNTING	77
81.43704.0077	23 323 077	STABILIZER MOUNTING	70
81.43704.0078	23 323 078	STABILIZER MOUNTING	70
81.43704.0079	63 450 835	STABILIZER MOUNTING	78
81.43705.0193	23 325 193	BRACKET	16
81.43705.0241	23 705 241	BRACKET	16
81.43705.0242	23 705 242	BRACKET	16
81.43706.0011	63 451 114	RUBBER BUSHING	44
81.43718.0043	23 718 043	BEARING CAP	14
81.43718.0044	23 718 044	BEARING CAP	15
81.43722.0019	63 450 139	STABILIZER MOUNTING	76
81.43722.0040	23 326 040	STABILIZER MOUNTING	72
81.43722.0047	23 323 047	STABILIZER MOUNTING	69
81.43722.0048	21 722 048	STABILIZER MOUNTING	69
81.43722.0051	23 326 062	STABILIZER MOUNTING	74
81.43722.0052	23 326 052	STABILIZER MOUNTING	73
81.43722.0053	23 326 053	STABILIZER MOUNTING	73
81.43722.0059	23 323 159	STABILIZER MOUNTING	71
81.43722.0060	23 326 062	STABILIZER MOUNTING	74
81.43722.0061	23 324 061	SPRING BUSHING	63
81.43722.0062	23 324 062	SPRING BUSHING	64
81.43722.0063	23 326 063	STABILIZER MOUNTING	74
81.43722.0068	23 326 068	STABILIZER MOUNTING	74
81.43722.0070	23 324 070	SPRING BUSHING	64
81.43722.0072	23 326 072	STABILIZER MOUNTING	74
81.43722.0083	23 327 083	STABILIZER MOUNTING	76
81.43722.0085	23 324 086	STABILIZER MOUNTING	71
81.43722.0087	21 000 012	STABILIZER MOUNTING	68
81.43722.0091	63 450 572	STABILIZER MOUNTING	77
81.43722.0092	63 450 579	STABILIZER MOUNTING	77
81.44204.0012	63 451 351	RUBBER MOUNTING	48
81.44204.0021	23 323 021	STABILIZER MOUNTING	69
81.44205.6009	23 330 009	KING PIN SET	34
81.44205.6010	21 330 004	KING PIN SET	32
81.44205.6010	23 330 010	KING PIN SET	34
81.44205.6011	21 330 005	KING PIN SET	32
81.44205.6012	21 330 006	KING PIN SET	33
81.44205.6013	23 330 013	KING PIN SET	34
81.44205.6016	23 330 016	KING PIN SET	34
81.44205.6018	23 330 018	KING PIN SET	35
81.44205.6019	21 330 007	KING PIN SET	33

Umschlüsselung OEM / Cross Reference OEM

MAN	AL-HU TECH	Description	Page
81.44205.6020	21 330 008	KING PIN SET	33
81.44205.6023	23 330 023	KING PIN SET	35
81.44205.6024	23 330 024	KING PIN SET	35
81.44205.6025	23 330 025	KING PIN SET	35
81.44205.6027	23 330 027	KING PIN SET	36
81.44205.6030	23 330 030	KING PIN SET	36
81.44205.6031	23 330 031	KING PIN SET	36
81.44205.6033	21 330 033	KING PIN SET	33
81.44205.6037	23 330 030	KING PIN SET	36
81.44205.6038	23 330 031	KING PIN SET	36
81.44215.0016	21 215 001	THRUST WASHER	80
81.44215.0017	63 450 687	THRUST WASHER	80
81.44301.0107	21 356 011	WHEEL HUB	89
81.44301.0146	21 356 012	WHEEL HUB	89
81.44301.0169	21 356 008	WHEEL HUB	88
81.44301.0174	21 356 019	WHEEL HUB	90
81.44301.0177	21 356 035	WHEEL HUB	90
81.44301.0179	21 356 014	WHEEL HUB	89
81.44301.0182	21 356 020	WHEEL HUB	90
81.44303.0022	23 303 022	WASHER	87
81.44303.0034	23 303 034	WASHER	87
81.44312.0003	21 334 025	HUB CAP	31
81.45503.0047	11.020.0805.191	HEX COLLAR NUT, black	30
81.45503.0055	63 450 842	WHEEL NUT	91
81.45503.0058	63 450 842	WHEEL NUT	91
81.45950.0004	63 450 101	COVER PLATE RAL9006	232
81.46105.6015	63 450 688	UNIVERSAL JOINT	333
81.46109.0038	63 450 142	STEERING BUSHING	328
81.46113.6042	27 113 042	STEERING SPINDLE	330
81.46122.6112	24 461 112	STEERING SHAFT	329
81.46430.0069	24 460 069	STEERING WHEEL	330
81.46433.6009	24 460 009	STEERING LOCK	328
81.46433.6013	24 460 013	STEERING LOCK	328
81.46610.6288	63 450 444	DRAG LINK	323
81.46610.6648	24 460 648	DRAG LINK	322
81.46610.6722	24 460 722	DRAG LINK	322
81.46610.6779	24 460 779	DRAG LINK	323
81.46611.6006	63 450 445	DRAG LINK	324
81.46611.6016	63 450 248	DRAG LINK	323
81.46611.6019	63 450 446	DRAG LINK	324
81.46611.6061	24 460 653	DRAG LINK	321
81.46611.6067	24 460 652	DRAG LINK	322
81.46611.6150	63 450 447	DRAG LINK	324
81.46611.6197	24 460 133	DRAG LINK	321
81.46611.6201	63 450 448	DRAG LINK	324
81.46710.6372	63 450 449	TIE ROD	331
81.46711.6712	63 450 450	TIE ROD	331
81.46711.6715	63 450 451	TIE ROD	331
81.46711.6725	24 460 725	TIE ROD	330
81.46711.6728	63 450 452	TIE ROD	331
81.46711.6729	63 450 453	TIE ROD	332
81.46711.6759	63 450 454	TIE ROD	332
81.46711.6762	27 467 762	DRAG LINK	323
81.46711.6778	24 460 654	DRAG LINK	322

Umschlüsselung OEM / Cross Reference OEM

MAN	AL-HU TECH	Description	Page
81.46711.6820	24 460 725	TIE ROD	330
81.46711.6921	63 450 160	TIE ROD	330
81.47101.6136	21 460 136	STEERING PUMP	329
81.47101.6137	21 460 137	STEERING PUMP	329
81.47101.6189	21 460 189	STEERING PUMP	329
81.47301.6030	21 460 502	OIL RESERVOIR	327
81.47301.6047	21 460 047	OIL RESERVOIR	327
81.47301.6048	27 000 000	OIL RESERVOIR	328
81.47302.0011	21 466 068	COVER	321
81.47303.0045	21 466 267	OIL DIPSTICK	327
81.48227.0006	26 000 001	PEDAL PAD	275
81.50101.5141	23 332 141	DUST COVER	26
81.50201.6184	24 420 184	BRAKE SHOE	122
81.50201.6188	24 420 188	BRAKE SHOE	122
81.50201.6190	24 420 019	BRAKE SHOE	121
81.50201.6218	24 420 519	BRAKE SHOE	122
81.50202.0108	63 451 679	BRAKE ANCHOR PLATE	118
81.50202.0127	06 501 568	BRAKE ANCHOR PLATE	118
81.50211.0018	63 451 352	BRAKE SHOE SPRING PIN	123
81.50211.0027	63 450 824	SPRING RETAINING PIN	142
81.50211.0030	63 451 115	PIN	40
81.50212.0036	22 001 002	BRAKE SHOE PIN	122
81.50212.0036S	22 001 003	BRAKE SHOE PIN REPAIR KIT	123
81.50301.0112	22 010 007	BRAKE CAMSHAFT	119
81.50301.0113	22 010 006	BRAKE CAMSHAFT	119
81.50301.0223	22 010 004	BRAKE CAMSHAFT	118
81.50301.0224	22 010 005	BRAKE CAMSHAFT	119
81.50301.0225	22 010 008	BRAKE CAMSHAFT	119
81.50301.0226	22 010 009	BRAKE CAMSHAFT	120
81.50308.0011	23 332 011	SEAL HOLDER	53
81.50410.6118	23 410 118	SPRING BRAKE CYLINDER	141
81.50610.6132	24 420 092	SLACK ADJUSTER KIT	139
81.50610.6210	22 420 210	SLACK ADJUSTER	137
81.50610.6211	22 420 211	SLACK ADJUSTER	137
81.50610.6220	63 451 116	SLACK ADJUSTER	138
81.50610.6221	63 453 049	SLACK ADJUSTER	138
81.50610.6222	63 451 117	SLACK ADJUSTER	138
81.50610.6266	63 451 145	SLACK ADJUSTER	138
81.50802.6007	22 420 008	CALIPER COVER SET	126
81.50802.6009	22 420 007	CALIPER BOLT REPAIR KIT	126
81.50802.6021	22 420 102	REPAIR KIT, BRONZE BUSHING	136
81.50802.6022	24 420 022	REPAIR KIT RUBBER BUSH	135
81.50802.6024	22 420 006	TAPPET HEAD REPAIR KIT	142
81.50802.6025	22 420 005	CALIPER BOLT REPAIR KIT	126
81.50811.0004	13 815 004	BRAKE WEAR INDICATOR	124
81.50822.0006	22 420 004	PISTON RETAINING PLATE	131
81.50822.6013	13 815 013	BRAKE WEAR INDICATOR	124
81.50822.6014	13 815 014	BRAKE WEAR INDICATOR KIT	125
81.50822.6015	13 815 015	BRAKE WEAR INDICATOR	124
81.50822.6016	13 815 011	BRAKE WEAR INDICATOR KIT	125
81.50822.6017	13 815 012	BRAKE WEAR INDICATOR	124
81.50822.6029	13 815 015	BRAKE WEAR INDICATOR	124
81.50822.6031	63 450 814	TAPPETS KIT	142
81.50822.6032	22 420 944	REPAIR KIT, BRAKE CALIPER	135

Umschlüsselung OEM / Cross Reference OEM

MAN	AL-HU TECH	Description	Page
81.51101.6455	24 106 027	BRAKE CHAMBER	120
81.51101.6481	24 106 028	BRAKE CHAMBER	121
81.51230.6009	24 002 107	SHUT-OFF VALVE	136
81.51270.6026	24 500 020	LINE FILTER, COMPRESSOR SYSTEM	131
81.51401.0129	63 450 689	AIR TANK	117
81.51401.0133	63 450 690	AIR TANK	117
81.51901.6005	22 010 001	BRAKE CAMSHAFT REPAIR KIT	120
81.51901.6006	24 420 006	BRAKE CAMSHAFT REPAIR KIT	120
81.52101.6022	63 451 124	PRESSURE LIMITER VALVE	132
81.52101.6073	63 451 124	PRESSURE LIMITER VALVE	132
81.52101.6076	24 303 473	PRESSURE REGULATOR	133
81.52101.6118	24 300 000	REPAIR KIT, UNLOADER VALVE	136
81.52101.6153	22 015 004	PRESSURE LIMITER VALVE	132
81.52101.6264	24 407 071	SILENCER	137
81.52101.6269	24 000 007	PRESSURE LIMITER VALVE	132
81.52101.6270	24 000 008	PRESSURE LIMITER VALVE	132
81.52101.6274	24 407 060	SILENCER	136
81.52101.6275	24 407 070	SILENCER	137
81.52101.6283	63 451 004	PRESSURE LIMITING VALVE	133
81.52102.6072	24 410 010	AIR DRYER	115
81.52102.6098	24 000 009	AIR DRYER	114
81.52102.6100	24 000 009	AIR DRYER	114
81.52102.6101	24 000 010	AIR DRYER	114
81.52102.6103	63 453 018	AIR DRYER	115
81.52102.6104	63 453 018	AIR DRYER	115
81.52102.6146	21 350 008	AIR DRYER CARTRIDGE	116
81.52108.6025	21 350 003	AIR DRYER CARTRIDGE	115
81.52116.6022	24 001 200	RELAY VALVE	134
81.52116.6070	63 450 152	RELAY VALVE	134
81.52116.6075	22 116 075	RELAY VALVE	133
81.52130.6104	63 451 125	REPAIR KIT	135
81.52130.6106	63 450 199	FOOT BRAKE VALVE	129
81.52130.6129	63 451 123	FOOT BRAKE VALVE	129
81.52130.6130	63 451 123	FOOT BRAKE VALVE	129
81.52130.6148	24 000 006	FOOT BRAKE VALVE	129
81.52130.6149	24 000 004	FOOT BRAKE VALVE	128
81.52130.6150	24 000 006	FOOT BRAKE VALVE	129
81.52130.6192	24 000 005	FOOT BRAKE VALVE	129
81.52130.6218	24 000 005	FOOT BRAKE VALVE	129
81.52130.6219	24 000 006	FOOT BRAKE VALVE	129
81.52130.6222	24 000 004	FOOT BRAKE VALVE	128
81.52131.6015	25 131 015	5/2 WAY VALVE	201
81.52131.6017	22 260 017	CUT-OFF VALVE	187
81.52150.6011	24 001 221	RELAY VALVE	134
81.52151.6073	63 450 191	4-CIRCUIT PROTECTION VALVE	143
81.52160.6087	22 160 087	SOLENOID VALVE	139
81.52161.6318	63 450 141	PRESSURE LIMITER VALVE	426
81.52170.6127	22 260 059	SHIFTING VALVE	199
81.52170.6128	22 260 757	SPLITTER VALVE	200
81.52170.6156	24 170 156	3/2 WAY VALVE	143
81.52185.6018	24 013 116	ENGINE STOP VALVE	128
81.52185.6023	22 036 000	3/2 DIRECTIONAL CONTROL VALVE	201
81.52301.6165	24 002 210	TRAILER CONTROL VALVE	142
81.52315.6086	63 450 198	HAND BRAKE VALVE	130

Umschlüsselung OEM / Cross Reference OEM

MAN	AL-HU TECH	Description	Page
81.52315.6090	63 450 198	HAND BRAKE VALVE	130
81.52315.6106	22 722 004	HAND BRAKE VALVE REPAIR KIT	130
81.52315.6156	24 430 118	HAND BRAKE VALVE	130
81.52403.6005	21 524 005	ABS PULSE WHEEL	2
81.52452.6014	24 000 002	ABS SOLENOID VALVE	98
81.52452.6015	24 000 002	ABS SOLENOID VALVE	98
81.54101.6055	21 130 064	AIR COMPRESSOR REPAIR KIT	113
81.54105.0024	21 130 038	AIR COMPRESSOR CYLINDER	104
81.54106.0006	21 130 025	AIR COMPRESSOR CONROD	102
81.54106.0013	21 130 039	AIR COMPRESSOR CONROD	102
81.54113.0036	21 130 040	AIR COMPRESSOR CRANKSHAFT	103
81.54113.0038	21 130 033	AIR COMPRESSOR CRANKSHAFT	103
81.54114.0022	21 130 043	AIR COMPRESSOR CYLINDER	104
81.54122.6004	21 130 004	AIR COMPRESSOR PRESSURE VALVE	112
81.54124.0005	21 130 132	AIR COMPRESSOR REPAIR KIT	113
81.54124.6013	21 130 048	AIR COMPRESSOR FLAP VALVE KIT	107
81.54124.6019	21 130 050	AIR COMPRESSOR FLAP VALVE KIT	107
81.54124.6023	21 130 023	AIR COMPRESSOR REPAIR KIT	112
81.54130.0011	21 131 011	AIR COMPRESSOR BUSHING	101
81.54901.0094	21 130 046	AIR COMPRESSOR GASKET	108
81.54901.0102	63 451 126	AIR COMPRESSOR GASKET	108
81.54901.6006	21 130 006	AIR COMPRESSOR GASKET SET	108
81.54901.6007	21 130 010	AIR COMPRESSOR GASKET SET	109
81.61110.0043	28 888 043	FRONT SERVICE DOOR, WIDE	244
81.61110.0053	28 888 053	FRONT SERVICE DOOR	244
81.61110.0063	26 611 063	PANEL	275
81.61110.6042	26 660 006	FRONT SERVICE DOOR	243
81.61110.6048	26 660 007	WIND DEFLECTOR RIGHT	306
81.61110.6049	26 660 008	WIND DEFLECTOR LEFT	305
81.61140.0016	28 880 016	GAS SPRING	244
81.61150.5060	28 888 060	RADIATOR GRILLE	277
81.61150.6050	28 880 050	RADIATOR GRILLE	277
81.61150.6051	28 880 051	RADIATOR GRILLE	277
81.61210.5310	28 880 310	MUDGUARD	271
81.61210.5311	28 880 311	MUDGUARD	271
81.61210.5363	28 880 363	MUDGUARD	272
81.61230.0066	28 881 066	GUARD PLATE RIGHT	249
81.61230.0067	28 881 067	GUARD PLATE LEFT	249
81.61444.0003	28 988 760	GLOVE BOX LOCK	248
81.61444.0013	26 444 013	TURN LOCK	303
81.61510.0129	28 660 129	STEPWELL LEFT	295
81.61510.0130	28 660 130	STEPWELL	291
81.61510.0158	28 660 141	STEPWELL	292
81.61510.0159	28 660 142	STEPWELL	292
81.61510.0225	28 660 225	STEPWELL	292
81.61510.0226	28 660 226	STEPWELL	293
81.61510.0229	28 660 229	STEPWELL	293
81.61510.0230	28 660 230	STEPWELL	293
81.61510.0262	28 660 262	STEP	289
81.61510.0263	28 660 263	STEP	289
81.61510.0267	28 660 267	STEP	289
81.61510.0268	28 660 268	STEP	289
81.61510.0273	28 666 273	STEP UPPER	291
81.61510.0333	28 660 333	STEPWELL	293

Umschlüsselung OEM / Cross Reference OEM

MAN	AL-HU TECH	Description	Page
81.61510.0355	28 666 355	STEPWELL	294
81.61510.0374	28 660 374	STEPWELL	294
81.61510.0382	28 666 382	STEPWELL	294
81.61510.0401	28 660 401	STEPWELL	294
81.61510.0402	28 660 402	STEPWELL RIGHT	295
81.61510.0408	28 660 408	MUDGUARDS EXTENSION, RIGHT	274
81.61510.0409	28 660 409	MUDGUARDS EXTENSION, LEFT	274
81.61510.0410	26 660 009	MUDGUARDS EXTENSION	274
81.61510.0411	26 660 010	MUDGUARDS EXTENSION	274
81.61510.0536	28 660 536	COVER STEPWELL	232
81.61510.5161	28 660 161	TRIM	301
81.61510.5162	28 660 162	TRIM	301
81.61510.5163	28 660 163	TRIM	301
81.61510.5164	28 660 164	TRIM	302
81.61510.5181	28 660 181	STEPWELL	292
81.61510.5187	28 666 187	STEP LOWER	290
81.61510.5196	28 660 196	STEP	288
81.61510.5197	28 660 197	STEP	288
81.61511.0001	28 666 001	STEP	290
81.61851.6023	28 618 023	CABIN LOCK	220
81.61851.6023	28 618 023B	CABIN LOCK	220
81.61901.0064	28 830 064	HEAT EXCHANGER	253
81.61901.0065	28 830 065	HEAT EXCHANGER	253
81.61901.0067	28 830 067	HEAT EXCHANGER	254
81.61901.6166	28 830 066	HEAT EXCHANGER	253
81.61910.0011	28 619 003	POLLEN FILTER	276
81.61910.0013	21 830 013	FLUID RESERVOIR	392
81.61910.0018	28 619 004	POLLEN FILTER	276
81.61910.0019	28 619 001	POLLEN FILTER	276
81.61910.6023	21 830 023	FLUID RESERVOIR	392
81.61910.6045	21 830 023	FLUID RESERVOIR	392
81.61930.0036	28 830 308	BLOWER MOTOR	209
81.61930.0042	28 830 208	BLOWER MOTOR	208
81.61930.0055	28 830 108	BLOWER MOTOR	208
81.61930.6098	28 830 003	BLOWER MOTOR	208
81.61967.0010	61 451 395	EXPANSION VALVE	378
81.61967.0020	28 880 020	EXPANSION VALVE	239
81.61967.6015	63 451 136	HEATER VALVE	405
81.61967.6022	28 880 022	CONTROL VALVE	229
81.61980.0043	63 451 135	HEATER VALVE	405
81.61980.6031	26 980 031	TEMPERATURE SWITCH	500
81.62158.5021	63 451 353	HOLDER	254
81.62340.6063	26 340 063	SEAT REPAIR KIT	284
81.62340.6064	26 340 064	SEAT REPAIR KIT	284
81.62383.6055	26 383 055	SEAT REPAIR KIT	285
81.62383.6057	26 383 057	SEAT REPAIR KIT	285
81.62384.6008	26 384 008	SEAT REPAIR KIT	285
81.62385.6025	26 385 025	SHOCK ABSORBER KIT	286
81.62385.6033	26 385 033	SEAT REPAIR KIT	285
81.62392.6003	26 392 003	SEAT REPAIR KIT	286
81.62398.6004	26 398 004	SEAT LEVELLING VALVE KIT	284
81.62398.6018	26 398 018	SEAT REPAIR KIT	286
81.62398.6019	26 398 019	SEAT REPAIR KIT	286
81.62410.0046	26 624 046	CORNER COVER	229

Umschlüsselung OEM / Cross Reference OEM

MAN	AL-HU TECH	Description	Page
81.62410.0047	26 624 047	CORNER COVER	229
81.62410.0048	28 790 048	WIND DEFLECTOR RIGHT	306
81.62410.0049	28 790 049	WIND DEFLECTOR LEFT	305
81.62410.0063	28 790 063	WIND DEFLECTOR LEFT	306
81.62410.0064	28 790 064	WIND DEFLECTOR RIGHT	306
81.62410.0089	26 624 089	WIND DEFLECTOR	305
81.62410.0090	26 624 090	WIND DEFLECTOR	305
81.62410.0091	26 624 091	CORNER COVER	230
81.62410.0092	26 624 092	CORNER COVER	230
81.62410.2224	28 620 224	SIDE TRIM	287
81.62410.2225	28 620 225	SIDE TRIM	288
81.62540.7000	63 450 691	STRIKER PLATE LEFT	295
81.62540.7001	63 450 692	STRIKER PLATE RIGHT	296
81.62600.4087	28 720 077	DOOR IN WHITE	236
81.62600.4088	28 720 078	DOOR IN WHITE	236
81.62630.0047	28 725 047	WINDOW FRAME, LEFT	307
81.62630.0048	28 725 048	WINDOW FRAME, RIGHT	308
81.62630.6020	28 720 020	DOOR PANNELING	239
81.62630.6021	28 720 021	DOOR PANELLING	238
81.62640.6010	63 450 693	WINDOW REGULATOR	310
81.62640.6011	63 450 694	WINDOW REGULATOR	310
81.62640.6051	63 450 695	WINDOW REGULATOR	310
81.62640.6052	63 450 696	WINDOW REGULATOR	311
81.62640.6055	28 640 055	WINDOW REGULATOR	309
81.62640.6056	28 640 056	WINDOW REGULATOR	309
81.62640.6057	28 721 046	WINDOW REGULATOR	309
81.62640.6058	28 721 146	WINDOW REGULATOR	310
81.62641.0001	63 450 697	DOOR HANDLE	235
81.62641.0076	63 450 698	WINDOW CRANK	307
81.62641.0088	63 450 699	DOOR HANDLE	235
81.62641.0089	63 450 700	DOOR HANDLE	235
81.62641.0099	28 720 099	DOOR HANDLE	234
81.62641.0100	28 720 100	DOOR HANDLE	234
81.62641.0101	28 720 101	PULL HANDLE	277
81.62641.6004	63 450 701	WINDOW CRANK	307
81.62641.6052	28 760 052	WINDOW CRANK	307
81.62641.6067	28 640 067	DOOR HANDLE	233
81.62641.6068	28 640 068	DOOR HANDLE	233
81.62641.6080	28 641 086	DOOR HANDLE	234
81.62641.6081	28 641 085	DOOR HANDLE	233
81.62641.6085	28 641 085	DOOR HANDLE	233
81.62641.6086	28 641 086	DOOR HANDLE	234
81.62641.6097	26 641 097	REPAIR KIT OUTSIDE DOOR HANDLE	280
81.62651.0075	63 450 279	SEALING FRAME	284
81.62670.6011	28 670 011	DOOR ARRESTOR	233
81.62680.0055	28 723 055	STRIKER PLATE	295
81.62680.0132	26 680 132	BOWDEN CABLE	209
81.62680.6065	63 450 702	DOOR LOCK	237
81.62680.6066	63 450 703	DOOR LOCK	238
81.62680.6095	28 626 095	DOOR LOCK	236
81.62680.6096	28 626 096	DOOR LOCK	237
81.62680.6107	28 723 107	DOOR LOCK	237
81.62680.6108	28 723 108	DOOR LOCK	237
81.62680.6121	63 451 138	DOOR LOCK	238

Umschlüsselung OEM / Cross Reference OEM

MAN	AL-HU TECH	Description	Page
81.62680.6122	63 451 139	DOOR LOCK	238
81.62690.0042	28 720 042	HINGE PART	254
81.62690.0046	28 723 046	BUSH	218
81.62690.0047	28 720 047	HINGE PART	254
81.62690.6036	26 690 036	DOOR HINGE	235
81.62690.6037	26 690 037	DOOR HINGE	236
81.62691.0007	28 723 007	PIN	275
81.62692.5001	28 692 001	SUPPORT	297
81.62900.6179	63 451 354	GAS SPRING	246
81.63701.0021	28 701 021	SUN VISOR	296
81.63701.0044	26 660 011	SUN VISOR	296
81.63701.0057	26 660 012	SUN VISOR	296
81.63730.6148	28 637 148	MIRROR	261
81.63730.6151	28 637 151	MIRROR	261
81.63730.6224	28 637 224	MIRROR GLASS	262
81.63730.6233	28 637 233	MIRROR	261
81.63730.6235	28 637 235	MIRROR	261
81.63730.6236	28 637 236	MIRROR	262
81.63730.6294	28 810 294	MIRROR	262
81.63730.6364	28 810 368	MIRROR	262
81.63730.6368	28 810 368	MIRROR	262
81.63730.6430	25 810 430	MIRROR	260
81.63730.6432	25 810 432	MIRROR	260
81.63730.6512	25 810 512	MIRROR	260
81.63730.6513	25 810 513	MIRROR	260
81.63731.0180	26 731 180	MIRROR COVER	266
81.63731.0183	63 450 704	MIRROR BRACKET	264
81.63731.0197	63 450 705	MIRROR BRACKET	264
81.63731.0228	63 450 706	MIRROR BRACKET	265
81.63731.0260	63 450 707	MIRROR COVER	267
81.63731.0261	63 450 708	MIRROR COVER	267
81.63731.0356	63 450 114	MIRROR CAP	265
81.63731.6489	28 810 489	MIRROR BRACKET	264
81.63731.6490	28 810 490	MIRROR BRACKET	264
81.63731.6501	63 450 709	MIRROR BRACKET	265
81.63731.6502	63 450 710	MIRROR BRACKET	265
81.63731.6550	63 450 711	REPAIR KIT	279
81.63731.6557	25 810 557	MIRROR ARM	263
81.63731.6560	25 810 560	MIRROR ARM	263
81.63731.6566	63 450 712	MIRROR ARM	263
81.63731.6569	63 450 713	MIRROR ARM	263
81.63731.6621	63 450 714	REPAIR KIT	279
81.63731.6622	63 450 715	REPAIR KIT	279
81.63732.0059	26 732 059	MIRROR COVER	266
81.63732.0061	28 638 061	MIRROR COVER	266
81.63732.0062	28 638 062	MIRROR COVER	266
81.63733.0027	28 637 027	MIRROR GLASS	268
81.63733.0030	28 637 030	MIRROR GLASS	269
81.63733.0061	28 637 061	MIRROR GLASS	269
81.63733.6007	28 637 007	MIRROR GLASS	268
81.63733.6049	25 810 049	MIRROR GLASS	268
81.63733.6057	25 810 057	MIRROR GLASS	268
81.63745.0016	26 745 016	TOOL BOX DOOR	300
81.63745.0017	26 745 017	TOOL BOX DOOR	301

Umschlüsselung OEM / Cross Reference OEM

MAN	AL-HU TECH	Description	Page
81.66410.0086	28 880 086	MUDGUARD	271
81.66410.0172	26 660 013	MUDGUARD	270
81.66410.0173	26 660 014	MUDGUARD	270
81.66410.0226	28 522 067	RUBBER FOR FENDER	283
81.66410.0293	26 641 293	MUDGUARD	269
81.66410.0294	26 641 294	MUDGUARD	269
81.66410.0306	26 641 306	MUDGUARD TRIM PLATE	273
81.66410.0307	26 641 307	MUDGUARD TRIM PLATE	273
81.66410.0308	26 641 308	MUDGUARD TRIM PLATE	273
81.66410.0309	26 641 309	MUDGUARD TRIM PLATE	273
81.66410.0352	28 880 352	MUDGUARD	271
81.66410.0353	28 880 353	MUDGUARD	272
81.66410.5080	28 881 080	MUDGUARD	272
81.66410.5081	28 881 081	MUDGUARD	272
81.66410.6086	26 660 015	MUDGUARD	270
81.66410.6606	26 660 016	MUDGUARD	270
81.66420.0125	26 420 125	BRACKET	212
81.66440.0192	28 520 192	RUBBER FOR FENDER	283
81.74249.6004	28 742 004	WINDOW MOTOR	308
81.74249.6005	28 742 005	WINDOW MOTOR	308
81.74364.0009	63 450 552	RETAINING PLATE	281
81.74821.0039	63 450 716	GAS SPRING	245
81.74821.0041	63 451 355	GAS SPRING	246
81.74821.0063	63 451 356	GAS SPRING	246
81.74821.0068	63 451 357	GAS SPRING	246
81.74821.0095	28 880 095	GAS SPRING	245
81.74821.0104	63 451 358	GAS SPRING	247
81.74821.0107	63 451 359	GAS SPRING	247
81.74821.0110	63 451 360	GAS SPRING	247
81.74821.0131	63 451 361	GAS SPRING	247
81.74821.0140	63 451 362	GAS SPRING	248
81.74821.0149	28 880 149	GAS SPRING	245
81.74940.6420	63 450 240	ROLLER GUIDE	282
81.74940.6421	63 450 241	ROLLER GUIDE	282
81.77930.6034	63 450 205	BLOWER MOTOR	209
81.77930.6050	63 450 205	BLOWER MOTOR	209
81.90001.0174	21 990 501	CARDAN BOLT	18
81.90001.0414	23 000 001	FITTED BOLT	146
81.90030.0146	23 000 015	CYLINDER LOCK SCREW	144
81.90490.0696	63 451 363	SCREW	53
81.90620.0047	21 353 126	NUT	38
81.90620.0048	21 620 048	LOCK RING	37
81.90620.0085	21 620 085	LOCK RING	258
81.90620.0092	63 450 192	LOCK RING M100X1,5	37
81.90685.0053	21 353 925	THREADED RING	79
81.90701.0722	616705	THRUST WASHER	79
81.90710.0057	21 710 057	WASHER	87
81.90711.0890	21 336 062	THRUST WASHER	80
81.90713.0014	22 713 014	DAMPING WASHER	187
81.90713.0015	22 713 015	DAMPING WASHER	187
81.90713.0243	24 420 243	SPACER	60
81.90713.0909	28 500 909	CABIN MOUNTING	222
81.90801.0225	21 994 109	LOCK PLATE	37
81.90820.0520	25 820 520	WIRE RING	201

Umschlüsselung OEM / Cross Reference OEM

MAN	AL-HU TECH	Description	Page
81.91605.0041	63 450 280	COVER	232
81.91605.0043	63 451 118	COVER	24
81.91710.0163	21 710 163	SPACER	60
81.91710.0357	63 450 086	GUIDE RING	190
81.93001.0319	23 460 319	CONTROL ARM BUSHING	24
81.93020.0427	21 301 015	STARTER SHAFT BUSHING	171
81.93020.0428	21 301 016	STARTER SHAFT BUSHING	171
81.93020.0525	63 450 112	BUSH	176
81.93020.0678	616706	KING PIN BUSHING	31
81.93020.0679	616707	KING PIN BUSHING	32
81.93020.0986	63 450 163	BUSH	176
81.93020.2315	63 451 364	BUSHING	17
81.93021.0218	616708	BUSH	16
81.95301.0040	63 450 455	BALL JOINT	318
81.95301.0048	63 451 365	BALL SOCKET	13
81.95301.6132	23 330 706	BALL JOINT REPAIR KIT	5
81.95301.6133	23 330 133	BALL JOINT REPAIR KIT	5
81.95301.6144	21 140 144	BALL JOINT	174
81.95301.6169	22 268 589	BALL JOINT	175
81.95301.6170	22 268 289	BALL JOINT	174
81.95301.6171	22 268 189	BALL JOINT	174
81.95301.6202	23 460 202	TIE ROD END	332
81.95301.6204	23 460 204	BALL JOINT	318
81.95301.6234	23 460 248	TIE ROD END	333
81.95301.6239	23 330 035	TIE ROD END	332
81.95301.6248	63 450 197	BALL JOINT	318
81.95301.6263	63 450 456	BALL JOINT	319
81.95301.6272	23 330 035	TIE ROD END	332
81.95301.6274	23 460 248	TIE ROD END	333
81.95301.6286	63 450 457	BALL JOINT	319
81.95301.6288	63 450 131	BALL JOINT	318
81.95301.6291	63 450 815	BALL JOINT	320
81.95301.6308	23 460 248	TIE ROD END	333
81.95301.6309	23 460 448	TIE ROD END	333
81.95301.6321	63 450 459	BALL JOINT	319
81.95301.6322	63 450 460	BALL JOINT	319
81.95301.6350	23 460 248	TIE ROD END	333
81.95301.6351	23 460 448	TIE ROD END	333
81.95302.0044	21 250 043	BALL JOINT	174
81.95302.0059	23 350 107	BALL JOINT REPAIR KIT	10
81.95302.0077	23 350 012	BALL JOINT REPAIR KIT	8
81.95310.0015	63 451 366	SEAL	53
81.95501.6261	21 300 261	BOWDEN CABLE	341
81.95501.6270	63 450 717	BOWDEN CABLE	210
81.95501.6367	21 300 367	BOWDEN CABLE	342
81.95501.6451	63 453 015	BOWDEN CABLE	343
81.95501.6452	63 450 718	BOWDEN CABLE	210
81.95501.6457	63 450 719	BOWDEN CABLE	211
81.95501.6459	21 300 459	BOWDEN CABLE	342
81.95501.6460	63 450 720	BOWDEN CABLE	211
81.95501.6477	63 450 721	BOWDEN CABLE	211
81.95501.6481	21 300 159	BOWDEN CABLE	341
81.95501.6487	21 300 359	BOWDEN CABLE	342
81.95501.6537	21 300 537	BOWDEN CABLE	342

Umschlüsselung OEM / Cross Reference OEM

MAN	AL-HU TECH	Description	Page
81.95820.0267	63 450 254	V-BELT PULLEY	460
81.96001.0517	28 522 517	GUIDE RING, BUMPER	249
81.96002.0328	63 450 722	BUMPER COVER	215
81.96002.0425	28 880 425	CAP, BUMPER	227
81.96002.0491	63 450 723	BUMPER COVER	215
81.96020.0186	23 321 186	RUBBER MOUNTING	45
81.96020.0202	21 241 202	ENGINE MOUNTING	27
81.96020.0230	23 321 230	SPRING BUFFER	62
81.96020.0235	21 241 235	ENGINE MOUNTING	360
81.96020.0286	63 451 367	STABILIZER MOUNTING	78
81.96020.0340	21 241 340	ENGINE MOUNTING	360
81.96020.0341	21 241 341	ENGINE MOUNTING	360
81.96020.0382	21 241 382	ENGINE MOUNTING	361
81.96020.0384	21 241 384	ENGINE MOUNTING	361
81.96020.0386	21 241 386	ENGINE MOUNTING	361
81.96020.0402	21 241 402	ENGINE MOUNTING	361
81.96020.0403	21 241 403	ENGINE MOUNTING	362
81.96020.6006	23 324 006	SPRING BUFFER	62
81.96101.0638	28 500 638	CAB TILT OUTER WASHER	218
81.96101.0659	21 205 659	RADIATOR RUBBER	438
81.96101.0732	63 450 217	WEATHERSTRIP	304
81.96101.0733	63 450 216	WEATHERSTRIP	304
81.96101.0739	23 324 739	SPRING BUFFER	63
81.96120.0001	28 720 001	WEATHERSTRIP	304
81.96120.0002	28 720 002	WEATHERSTRIP	304
81.96210.0023	63 453 048	ENGINE MOUNTING	28
81.96210.0052	21 500 052	RADIATOR MOUNTING	437
81.96210.0063	63 450 481	PROPELLER SHAFT MOUNTING	43
81.96210.0089	22 268 089	GEARBOX MOUNTING	188
81.96210.0096	21 240 002	RUBBER MOUNTING	440
81.96210.0100	63 451 368	RUBBER MOUNTING	49
81.96210.0101	21 500 101	RADIATOR MOUNTING	437
81.96210.0121	63 451 120	RUBBER MOUNTING	46
81.96210.0130	63 451 369	RUBBER MOUNTING	49
81.96210.0132	63 451 370	RUBBER MOUNTING	49
81.96210.0150	23 323 150	STABILIZER MOUNTING	71
81.96210.0153	21 500 153	EXHAUST MOUNTING	375
81.96210.0184	63 453 047	RUBBER MOUNTING	53
81.96210.0238	63 453 050	ENGINE MOUNTING	29
81.96210.0240	21 000 013	RUBBER MOUNTING	45
81.96210.0242	63 450 048	ENGINE MOUNTING	363
81.96210.0243	63 451 119	RADIATOR MOUNTING	43
81.96210.0247	63 450 200	RUBBER MOUNTING	283
81.96210.0248	21 500 248	RADIATOR MOUNTING	437
81.96210.0267	22 260 267	RUBBER MOUNTING	194
81.96210.0274	28 890 274	CABIN MOUNTING	222
81.96210.0278	63 451 371	RUBBER MOUNTING	49
81.96210.0289	63 451 372	RUBBER MOUNTING	50
81.96210.0294	63 451 373	RUBBER MOUNTING	50
81.96210.0302	63 451 121	ENGINE MOUNTING	28
81.96210.0348	63 451 374	RUBBER MOUNTING	50
81.96210.0353	63 451 375	RUBBER MOUNTING	50
81.96210.0364	63 450 087	CABIN MOUNTING	17
81.96210.0366	28 210 366	ENGINE MOUNTING	362

Umschlüsselung OEM / Cross Reference OEM

MAN	AL-HU TECH	Description	Page
81.96210.0367	63 450 541	ENGINE MOUNTING	28
81.96210.0373	21 241 373	ENGINE MOUNTING	27
81.96210.0379	63 450 049	RUBBER MOUNTING	45
81.96210.0388	22 240 388	RUBBER MOUNTING	194
81.96210.0400	28 890 400	CABIN MOUNTING	222
81.96210.0402	63 451 376	RUBBER MOUNTING	51
81.96210.0406	63 450 136	ENGINE MOUNTING	239
81.96210.0407	28 890 407	CABIN MOUNTING	222
81.96210.0407	28 890 407S	CABIN MOUNTING KIT	224
81.96210.0426	21 500 426	RADIATOR MOUNTING	437
81.96210.0430	26 240 001	RUBBER BUFFER	282
81.96210.0431	23 326 431	SPRING BUFFER	63
81.96210.0437	28 317 412	CABIN MOUNTING	221
81.96210.0437	28 500 437	CABIN MOUNTING KIT	224
81.96210.0439	63 453 023	ENGINE MOUNTING	363
81.96210.0440	28 240 003	ENGINE MOUNTING	362
81.96210.0441	28 240 005	ENGINE MOUNTING	363
81.96210.0447	23 350 447	AXLE ROD MOUNTING	3
81.96210.0448	23 350 448	AXLE ROD MOUNTING	4
81.96210.0450	23 326 450	STABILIZER MOUNTING	76
81.96210.0452	23 326 511	STABILIZER MOUNTING	76
81.96210.0462	28 890 462	CABIN MOUNTING	223
81.96210.0479	63 450 085	RUBBER BUFFER	44
81.96210.0508	63 450 080	RUBBER MOUNTING	46
81.96210.0511	23 326 511	STABILIZER MOUNTING	76
81.96210.0515	28 890 515	CABIN MOUNTING	223
81.96210.0536	28 890 536	CABIN MOUNTING	223
81.96210.0540	63 450 540	RUBBER MOUNTING	46
81.96210.0550	23 325 550	SPRING CUSHION	66
81.96210.0552	21 210 552	ENGINE MOUNTING	26
81.96210.0554	23 325 554	SPRING CUSHION	66
81.96210.0555	23 325 555	SPRING CUSHION	66
81.96210.0571	28 240 004	ENGINE MOUNTING	363
81.96210.0574	63 450 088	ENGINE MOUNTING	27
81.96210.0597	63 450 089	ENGINE MOUNTING	27
81.96210.0603	63 450 194	CABIN MOUNTING	18
81.96210.0604	63 450 136	ENGINE MOUNTING	239
81.96210.0605	63 450 733	ENGINE MOUNTING	239
81.96210.5011	63 451 377	RUBBER MOUNTING	51
81.96210.5022	23 325 022	SPRING CUSHION	65
81.96210.5025	23 325 025	SPRING CUSHION	65
81.96210.6072	63 450 090	ENGINE MOUNTING	28
81.96301.0321	63 451 378	TURBO HOSE	453
81.96301.0323	63 451 379	TURBO HOSE	453
81.96301.0387	21 095 582	TURBO HOSE	451
81.96301.0458	63 451 380	TURBO HOSE	453
81.96301.0581	21 501 581	RADIATOR HOSE	433
81.96301.0587	21 094 582	INTERCOOLER HOSE	413
81.96301.0590	21 094 982	TURBO HOSE	450
81.96301.0594	21 094 883	TURBO HOSE	450
81.96301.0600	21 094 782	TURBO HOSE	449
81.96301.0622	21 095 001	RADIATOR HOSE	429
81.96301.0624	21 094 083	TURBO HOSE	448
81.96301.0639	21 501 639	REDUCING SLEEVE	438

Umschlüsselung OEM / Cross Reference OEM

MAN	AL-HU TECH	Description	Page
81.96301.0648	21 095 482	TURBO HOSE	451
81.96301.0659	21 500 659	RADIATOR HOSE	433
81.96301.0677	21 500 677	RADIATOR HOSE	433
81.96301.0894	21 095 002	RADIATOR HOSE	429
81.96301.0895	21 095 003	RADIATOR HOSE	430
81.96301.0896	21 095 004	RADIATOR HOSE	430
81.96301.0898	21 501 898	RADIATOR HOSE	434
81.96301.0900	21 094 882	TURBO HOSE	450
81.96301.0904	21 095 005	RADIATOR HOSE	430
81.96301.0906	21 095 006	RADIATOR HOSE	430
81.96305.0088	21 500 088	RADIATOR HOSE	432
81.96305.0129	21 501 129	RADIATOR HOSE	433
81.96305.0134	21 500 134	TURBO HOSE	452
81.96305.0166	21 095 007	RADIATOR HOSE	431
81.96305.0192	21 095 008	RADIATOR HOSE	431
81.96305.0197	21 095 009	RADIATOR HOSE	431
81.96305.0200	21 095 010	RADIATOR HOSE	431
81.96305.0207	21 095 682	RADIATOR HOSE	432
81.96305.0217	21 095 011	HEATER HOSE	404
81.96305.0235	21 095 012	HEATER HOSE	404
81.96305.0262	21 095 013	HEATER HOSE	405
81.96305.0272	21 095 014	HEATER HOSE	405
81.96305.0304	21 095 015	RADIATOR HOSE	432
81.96305.0312	21 095 782	RADIATOR HOSE	432
81.96320.0126	21 094 126	TURBO HOSE	449
81.96320.0132	21 095 082	TURBO HOSE	451
81.96320.0159	21 095 382	TURBO HOSE	451
81.96320.0162	21 094 513	INTERCOOLER HOSE	412
81.96320.0168	21 094 182	TURBO HOSE	449
81.96320.0175	21 094 482	TURBO HOSE	449
81.96340.0902	63 450 076	AIRCOIL	117
81.96401.0152	23 350 013	BALL JOINT REPAIR KIT	8
81.96420.0118	28 420 000	BELLOW	337
81.96420.0142	22 260 121	BELLOW	175
81.96420.0156	63 450 724	CORRUGATED HOSE	231
81.96420.0207	63 451 381	BELLOWS SEAL	118
81.96420.0242	21 098 242	BELLOW	337
81.96420.0324	22 260 324	GEAR LEVER BOOT	188
81.96420.0519	21 528 519	BELLOW	337
81.96420.0529	63 450 091	BELLOW	15
81.96503.0129	26 503 129	SEAL RING	283
81.96503.0226	63 450 140	SQUARE SEAL	442
81.96503.0333	21 503 333	OIL SEAL	38
81.96503.0443	26 503 443	OIL SEAL	275
81.96601.0298	21 601 298	GASKET	29
81.97001.5081	63 450 725	GRAB HANDLE	248
81.97001.5082	63 450 726	GRAB HANDLE	248
81.97006.0003	28 880 005	GAS SPRING	244
81.97006.0033	63 450 727	GAS SPRING	245
81.97010.0210	22 260 010	COVER, GEARSHIFT	186
81.97010.0211	63 450 728	COVER, GEARSHIFT	187
81.97010.6001	63 450 838	SHIFT KNOB	198
81.97010.6007	22 260 012	SHIFT KNOB	196
81.97010.6010	22 260 001	SHIFT KNOB	195

Umschlüsselung OEM / Cross Reference OEM

MAN	AL-HU TECH	Description	Page
81.97010.6011	22 260 011	SHIFT KNOB	196
81.97010.6012	22 260 002	SHIFT KNOB	195
81.97010.6013	22 260 013	SHIFT KNOB	197
81.97010.6021	22 260 021	SHIFT KNOB	197
81.97100.6030	63 450 729	LOCK SET	259
81.97100.6031	63 450 730	LOCK SET	259
81.97100.6034	28 971 034	LOCK SET	258
81.97100.6098	28 971 098	LOCK SET	258
81.97100.6099	28 971 099	DOOR HANDLE	234
81.97106.6015	63 450 731	CLAMP LOCK	227
81.97116.0099	63 450 215	SNAP LOCK	288
81.97122.0028	28 880 028	LOCK, GRILL	259
81.97420.0023	24 997 023	EXHAUST CLAMP	364
81.97420.0026	24 997 026	EXHAUST CLAMP	365
81.97420.0073	24 997 073	EXHAUST CLAMP	365
81.97420.0085	24 997 085	EXHAUST CLAMP	365
81.97420.0139	24 997 085	EXHAUST CLAMP	365
81.97420.0152	24 997 152	EXHAUST CLAMP	366
81.97420.0157	24 997 157	EXHAUST CLAMP	366
81.97420.2017	24 997 017	EXHAUST CLAMP	364
81.97420.5045	63 451 382	EXHAUST CLAMP	366
81.97440.0170	63 450 732	HOSE CLAMP	255
81.97440.0205	21 970 205	HOSE CLAMP	407
81.97460.6021	63 451 383	EXHAUST CLAMP	367
81.97610.0208	22 000 032	BRAKE SHOE SPRING	123
81.97610.0224	63 451 384	SPRING	141
81.97610.0265	22 610 265	SPRING	140
81.97610.0271	63 451 385	SPRING	141
81.97610.0317	22 000 031	BRAKE SHOE SPRING	123
81.97610.6013	63 451 386	SPRING	141
81.98701.0014	63 451 122	EXHAUST GASKET	367
81.99164.8844	23 326 511	STABILIZER MOUNTING	76
81.99917.8469	63 450 021	UNIVERSAL JOINT	83
82.43701.6017	63 451 395	SHOCK ABSORBER	59
82.46610.6184	63 450 461	DRAG LINK	325
82.52102.0013	21 350 001	AIR DRYER CARTRIDGE	115
82.96301.0011	21 500 659	RADIATOR HOSE	433
83.77953.6501	61 451 396	DRYER BOTTLE	359
83.78611.6001	63 450 568	REPAIR KIT	279
84.43610.6006	23 500 008	AIR SPRING VALVE	116
84.52101.6017	24 303 474	PRESSURE REGULATOR	133
85.12501.0002	21 470 002	WATER SEPERATOR FILTER	468
85.12501.0003	21 470 002	WATER SEPERATOR FILTER	468
85.20001.2158	25 226 259	STEERING COLUMN SWITCH	494
85.32734.6001	22 260 157	MULTIWAY VALVE	191
85.41610.4013	63 450 575	COVERING	232
85.41715.0006	21 000 014	RUBBER BUSHING	44
85.41722.6010	63 450 082	SHOCK ABSORBER	58
85.41722.6011	63 450 196	SHOCK ABSORBER	59
85.41722.6017	63 453 008	CABIN DAMPER	220
85.41722.6022	28 890 003	CABIN SHOCK ABSORBER	225
85.41722.6023	63 450 106	CABIN SHOCK ABSORBER	227
85.41723.6011	28 553 201	CABIN PUMP	225
85.41723.6020	28 553 201	CABIN PUMP	225

Umschlüsselung OEM / Cross Reference OEM

MAN	AL-HU TECH	Description	Page
85.41723.6044	28 553 201	CABIN PUMP	225
85.43220.6002	23 350 002	BALL JOINT REPAIR KIT	6
85.43704.0002	63 451 387	RUBBER MOUNTING	51
85.43704.0005	63 450 571	STABILIZER MOUNTING	77
85.43722.0007	63 451 388	RUBBER MOUNTING	51
85.43722.0010	63 451 389	RUBBER MOUNTING	52
85.43722.0011	63 451 390	RUBBER MOUNTING	52
85.46610.6102	63 450 462	DRAG LINK	325
85.46610.6104	63 450 463	DRAG LINK	325
85.46610.6140	63 450 464	DRAG LINK	325
85.46610.6163	63 450 465	DRAG LINK	326
85.46610.6244	63 450 466	DRAG LINK	326
85.46610.6246	63 450 467	DRAG LINK	326
85.46610.6247	63 450 468	DRAG LINK	326
85.61210.0021	26 210 021	STEP HOUSING	290
85.61210.0022	26 210 022	STEP HOUSING	290
85.61510.5027	28 660 027	STEPWELL	291
85.61510.5028	28 660 028	STEPWELL	291
85.61851.6003	28 618 003	CABIN LOCK	220
85.61950.0025	28 619 002	POLLEN FILTER	276
85.62640.6011	26 640 011	WINDOW REGULATOR	308
85.62640.6012	26 640 012	WINDOW REGULATOR	309
85.63710.0009	28 811 009	MIRROR COVER	267
85.63710.0010	28 811 010	MIRROR COVER	267
85.90710.0014	63 450 113	STOP WASHER	78
85.96020.0004	63 450 120	CABIN MOUNTING	223
85.96210.0008	63 451 391	RUBBER MOUNTING	52
85.96210.0012	28 500 012	CABIN MOUNTING	221
85.96210.0019	28 500 019	CABIN MOUNTING	221
85.96210.0020	63 451 392	RUBBER MOUNTING	52
85.96210.0021	28 500 021	CABIN MOUNTING	221
85.96210.0025	63 451 661	SPRING MOUNTING	67
85.96210.0030	63 450 134	CABIN MOUNTING	224
85.96210.0039	63 450 458	RUBBER BUFFER	44
85.96501.0002	63 451 393	GASKET	29
88.15701.6003	21 430 826	AIR CYLINDER	335
88.25310.6002	25 215 002	INDICATOR RELAY	164
88.25311.0002	63 450 009	CONTROL UNIT	473
88.43704.0002	21 240 001	RUBBER MOUNTING	45
88.96210.0057	63 450 129	RUBBER BUFFER	282
90.81690.1173	21 825 071	DRIVE BEARING, STARTER	162

Garantie

Alle ALHU-tech-Produkte sind im Bezug auf Materialfehler und Fertigungsmängel garantiert. Diese Garantie beschränkt sich ausschließlich auf den Ersatz des fehlerhaften Bestandteils. Wir übernehmen keine Haftung für Schäden, die sich aufgrund von Missbrauch, Vernachlässigung, Unfall, Abnutzung und Verschleiß ergeben. Alle Verluste und Folgeschäden sind ausdrücklich ausgeschlossen. Forderungen bezüglich Schäden oder Unstimmigkeiten hinsichtlich von Produktlieferungen der Firma ALHU Fahrzeugtechnik GmbH sind unmittelbar und schriftlich vorzulegen. Dieser Katalog enthält das komplette ALHU-tech-Programm an Automobil-Elektroteilen und dient als Leitfaden der möglichen Einsatzbereiche. Obwohl wir bei der Erstellung dieser Angaben höchste Sorgfalt angewandt haben, können wir keine Gewähr für die absolute Richtigkeit der Informationen abgeben. Technische und konstruktive Produktänderungen können im Laufe der Gültigkeit dieses Katalogs erforderlich sein, so dass sich möglicherweise Unterschiede zwischen den ursprünglichen Abbildungen und tatsächlich gelieferten Produkten ergeben.

Guarantee

All ALHU-tech products are guaranteed against defects arising from faulty materials or workmanship. The guarantee is limited to the replacement of the faulty part; we cannot extend the guarantee to cover defects caused by misuse, neglect, accident or wear and tear. We cannot accept liability for consequential loss or damage which is claimed to have resulted from use of one of our products. Claims resulting from damage or discrepancies during delivery of goods from ALHU Fahrzeugtechnik GmbH must be made without delay and reported in writing. This catalogue shows the range of ALHU-tech auto-electrical parts and is a guide to the vehicles to which they apply. Whilst great care has been taken in the preparation of the catalogue we cannot guarantee the complete accuracy of this information. In some instances technical and design changes may be necessary during the life of this catalogue which may result in some difference between the original illustrations and products currently supplied.

Garantie

Toutes les pièces ALHU-tech figurant dans ce catalogue sont garanties contre tout vice de fabrication. La garantie est limitée au remplacement du produit défectueux; la garantie ne couvre pas des défauts résultants d'abus, négligence, accident ou usure. Nous ne pouvons pas accepter la responsabilité pour des pertes ou dégâts résultants de l'emploi de nos produits. Les réclamations résultants de produit endommagé ou manquant au livraison doivent être communiquées sans délai et par écrit à ALHU Fahrzeugtechnik GmbH. Les références, numéros d'origine ou autres, étrangers aux numéros propres de ALHU-tech ne sont portés qu'à titre indicatif et ne peuvent en aucun cas donner matière à confusion. De temps en temps des modifications techniques peuvent être nécessaires, résultant dans des différences entre les illustrations et les produits fournis.

Garanzia

Tutti i prodotti ALHU-tech sono garantiti da difetti derivanti da materiali non conformi o da cattiva esecuzione. La garanzia è limitata alla sostituzione delle parti difettate; la garanzia non vale per difetti causati da utilizzo improprio, danni a usura. Non ci riteniamo responsabili per eventuali difetti o danni derivanti da un cattivo utilizzo dei nostri prodotti.

Eventuali reclami per danni o difetti causati durante il trasporto dalla ALHU Fahrzeugtechnik GmbH ci devono pervenire per tempo e per iscritto.

Il presente catalogo illustra la gamma delle parti elettriche delle automobili ALHU-tech ed è una guida per i veicoli a cui esse vanno applicate.

Nonostante il catalogo sia stato preparato con grande accuratezza, non garantiamo l'esattezza delle informazioni contenute.

Per alcuni modelli potrebbero essere necessarie delle modifiche o di design, perciò potrebbero riscontrarsi delle differenze tra le illustrazioni originarie ed i prodotti forniti dopo la distribuzione del catalogo.

Garantia

Todos os produtos da ALHU-tech tem garantia contra defeito de material ou de mau-de-obra. A garantia limita-se a troca da peça defeituosa e não podemos estender a garantia a defeitos provocados por mau uso, negligência, acidente ou desgaste. Também não podemos tomar a responsabilidade por qualquer perda ou dano que se pretenda tenha resultado do uso de qualquer dos nossos produtos. Reclamações sobre danos ou faltas na entrega, devem ser feitas o mais rápido possível e por escrito.

Este catálogo apresenta a gama de peças auto-eléctricas da ALHU-tech e, e um guia para os automóveis nas quais se aplicam. Embora tenha sido prestado o maior cuidado na compilação deste catálogo, não podemos garantir a sua completa exactitude.

Em alguns casos, alterações técnicas ou ilustrativas podem ser necessárias durante a existência deste catálogo, as quais poderão resultar em diferenças entre as ilustrações e os produtos fornecidos actualmente.

Garantía

Todos los productos de ALHU-tech estan garantizados contra defectos de material o de mano de obra - la garantía se limita al cambio de la pieza defectuosa, no podemos extender la garantía a defectos causados por mal uso, negligencia, accidente o desgaste - tampoco podemos aceptar responsabilidad por cualquier pérdida o daño que se pretenda haya resultado en el uso de cualquiera de nuestros productos. Reclamaciones, sobre daños o faltas en las entregas, deberan hacerse sin pérdida de tiempo y por escrito.

Este catálogo muestra la gama de las piezas autoeléctricas de ALHU-tech y es una guía para los automóviles a los cuales se aplican. Si bien se ha prestado mucha atención, no podemos garantizar su completa exactitud.

En algunos casos, cambios técnicos o en el diseño, pueden ser necesarios durante la existencia de este catálogo, lo cual puede resultar en diferencias entre las ilustraciones y los productos suministrados actualmente.

Auszug aus unseren Allgemeinen Lieferungs- und Garantiebedingungen.

Gültig für Angebote, Verkäufe und Lieferungen.

Angebote sind freibleibend und ohne Verbindlichkeit für uns. Wenn nicht anders vereinbart, verstehen sich alle Preise netto, ab Werk einschließlich Verpackung.

Es werden die am Tage der Lieferung gültigen Preise berechnet. Bei Sonderanfertigungen sind Ober- oder Unterlieferungen bis zu 10% der bestellten Menge zulässig.

Mängelrügen gegen Gewicht, Stückzahl, Güte oder Ausführung der Ware können nur berücksichtigt werden, wenn sie unverzüglich mitgeteilt werden. Wir garantieren für gute Qualität und sorgfältige Ausführung der gelieferten Ware auf die Dauer von zwölf Monaten (ab Versanddatum gerechnet). Diese Garantie erstreckt sich auf Material- und Fabrikationsfehler, die sich im Laufe dieses Zeitabschnittes zeigen. Wir verpflichten uns, während der Dauer der Garantie defekte Teile kostenlos instand zu setzen, zu ersetzen oder zu vergüten.

Unsere Garantie erstreckt sich nicht über den natürlichen Verschleiß von Bestandteilen sowie Schäden noch deren Folgen, welche durch falsche Bedienung, Nachlässigkeit, übermäßige Beanspruchung verursacht werden. Unsere gesamte Garantie erlischt sofort, wenn Änderungen oder Reparaturen ohne Zustimmung vorgenommen werden. Zeichnungen, Unterlagen und Entwürfe unserer Firma dürfen vom Empfänger irgendwelchen dritten Personen nicht bekannt gegeben werden.

Sämtliche Angaben dieses Kataloges sind mit größter Sorgfalt zusammengestellt worden, und sind - soweit wir feststellen können - richtig. Irgendwelche Ersatzansprüche aufgrund unserer Katalogangaben können jedoch nicht anerkannt werden. Hinweise auf Fehler sind uns stets willkommen.

Nachdruck

Auch auszugsweise nicht gestattet: Alle Rechte, insbesondere die der Vervielfältigung, sowie der Speicherung auf Datenträgern - auch auszugsweise - bleiben vorbehalten.

Wichtiger Hinweis

Teile-Nummern anderer Hersteller sind ausschließlich zu Vergleichszwecken aufgeführt. Diese dürfen in Rechnungen an Endverbraucher nicht verwendet werden.

ALHU Fahrzeugtechnik GmbH, D-22301 Hamburg